

PROCEEDINGS BOOK



INTERNATIONAL ASIAN CONGRESS ON CONTEMPORARY SCIENCES - VII

ISBN:978-625-6380-87-5

December 9-11, 2022

Olongapo City, Philippines

Central Luzon College of Science and Technology



Editors

Prof. ANA LIZA GARCIA

Prof. JESSON HERO

SAMIRA KHADHRAOUI ONTUNC

All rights of this book belongs to IKSAD.
Without permission can't be duplicate or copied.
Authors of chapters are responsible both ethically
and juridically.

Issued: 25.12.2022

ISBN:978-625-6380-87-5



CONFERENCE ID

TITLE

INTERNATIONAL ASIAN CONGRESS ON CONTEMPORARY SCIENCES - VII

DATE

09- 11 December 2022

PLACE

Olongapo City, Philippines

ORGANIZING ORGANIZATION

Central Luzon College of Science and Technology, Olongapo City,
Philippines

Total Number of Papers from Turkey

56

Total Number of International Papers

*Philippines, Turkey, Azerbaijan, Kyrgyzstan, Indonesia, Pakistan,
Romania, Morocco, Ethiopia, Italy, Hungary, UK, Ethiopia,
Nigeria, Iran*

59

NUMBER OF ACCEPTED PAPERS

115

NUMBER OF REJECTED PAPERS

64

EVALUATION PROCESS

All applications have undergone a double-blind peer review process

PRESENTATION

Oral presentation



ORGANIZATION BOARD

Rene Paulo M. Legaspi, Ph.D.

Senior Vice President, Central Luzon College of Science and Technology Honorary Chairman

John James A. Larafoster, Ed.D.

Director for Academics, Training, Research, and Extension, Central Luzon College of Science and Technology
Honorary Vice Chairman

Froilan D. Mobo, DPA, Ph.D.

Assistant Director, DRDE / Associate Professor, Philippine Merchant Marine Academy
Head of the Organizing Committee

Ana Liza R. Garcia

Chairman, International Human Rights Movement
Organizing Committee Member

Ronel S. De Guzman, MSA

President Ramon Magsaysay State University

Prof. Jesson Hero

Academic Senior High School of Meycuayan City

Prof. Dr. Bülent Cercis TANRITANIR

Van Yüzüncü Yıl University

Prof. Dr. Atiya Abuharris

American University of Libya



ORGANIZATION BOARD

Assoc. Prof. Gulbaxar TAVALDIËVA

Tashkent Chemical-Technological Institute

Assoc. Prof. Mirna Fawaz

Beirut Arab University

Cavid ISMAYILOV

Nakhchivan State University

Elvan Cafarov

Azerbaijan State Pedagogical University

GENERAL COORDINATOR

SAMIRA KHADHRAOUI ONTUNC

CONFERENCE LANGUAGES

Turkish, Azerbaijanian, English, Russian, Arabic



SCIENTIFIC & ADVISORY BOARD

Dr. Myla Arcinas, De La Salle University, Philippines

Dr. Nemia Galang, President Ramon Magsaysay State University, Philippines

Dr. John Mark R. Asio, Gordon College, Philippines

Dr. Victoria P. Valenzuela, Bulacan State University, Philippines

Dr. Levixon Lundi, Theophany University, Haiti

Prof. Jesson Hero, Academic Senior High School of the City of Meycauayan,
Philippines

Dr. Abdul Rahmat, Universitas Negeri Gorontalo, Indonesia

Prof. Yusuf Iskandar, Nusa Putra University, Indonesia

Prof. Viveka Nand Sharma, Assam Don Bosco University, India

Prof. Ronel S. de Guzman, President Ramon Magsaysay State University,
Philippines

Dr. Bernandino Malang, Bulacan State University, Philippines

Edwin Ibanez, Ph.D., Central Luzon State University, Philippines

Prof. Dr. Aldemir Malveira de Oliveira, Centro Universitário de Ensino
Superior do Amazonas, Brasil

Prof. Dr. Bülent Cercis TANRITANIR, Van Yüzüncü Yıl University, Turkey

Prof. Dr. Hatice Zeynep İnan, Bursa Uludağ University, Turkey

Prof. Dr. S. Sunay Yıldırım Doğru, Dokuz Eylül University, Turkey

**INTERNATIONAL ASIAN CONGRESS ON CONTEMPORARY
SCIENCES - VII**



SCIENTIFIC & ADVISORY BOARD

Assoc. Prof. Dr. Aykut EKİYÖR, Ankara Hacı Bayram Veli University, Turkey

Assoc. Prof. Dr. B. Mahendran, VIT Bhopal University, India

Assoc. Prof. Dr. Serkan NAKTİYOK, Ataturk University, Turkey

Assoc. Prof. PhD. Cuciuc Romanescu Laura Sinziana, Ovidius University of
Constanța, Romania

Assist. Prof. Dr. Navdeep Kumar, Lyallpur Khalsa College, India

Assist. Prof. Dr. Numan Bildirici, Van Yüzüncü Yıl University, Turkey

Assist. Prof. Dr. Shazia Aziz, COMSATS University Islamabad, Pakistan

Assist. Prof. Dr. Sovik Mukherjee, St. Xavier's University, India

Dr. Cengiz KARAGÖZ, Namik Kemal University, Turkey

Dr. Iosefina Blazsani-Batto, Azerbaijan University of Languages, Azerbaijan

Dr. Irina-Ana Drobot, Technical University of Civil Engineering Bucharest,
Romania

Dr. Ersoy GÜMÜŞ, Istanbul University, Turkey

Dr. K.R. Padma, Sri Padmavati Mahila Visvavidyalayam (Women's) University,
India

**INTERNATIONAL ASIAN CONGRESS ON CONTEMPORARY
SCIENCES - VII**



CONFERENCE GALLERY



INTERNATIONAL ASIAN CONGRESS ON CONTEMPORARY SCIENCES - VII



CONFERENCE GALLERY

INTERNATIONAL ASIAN CONGRESS ON CONTEMPORARY SCIENCES-VII

Participants visible in the gallery:

- IKSAD Philippines
- Celtech College FAJIL LEGASPI
- CELTECH COLLEGE, John James Carafortter
- ABDERRAHMANE AGACHTOU
- PRMSU Royal De Guzman
- Dave Tejarat
- Columbian College, Mr. Santiago Jimenez
- Jefferson Sadera
- Rey E. Enciso
- Fevine Von Astidio
- JAKE G. RUMBAOA

Kaydediliyor... H3-S1-Fisy Amalia ekranını görüntüyorsunuz Seçenekleri Görüntüle Kalan: 09:49:35 Görüntüle

THE EFFECTIVENESS OF WOMEN FARMERS' GROUP PROGRAMS AGAINST FOOD INSECURITY DURING THE COVID-19 PANDEMIC (STUDY CASE IN BUARAN, TANGSEL, INDONESIA) - Adobe Acrobat Reader (32-bit)

THE EFFECTIVENESS OF WOMEN FARMERS' GROUP PROGRAMS AGAINST FOOD INSECURITY DURING THE COVID-19 PANDEMIC (STUDY CASE IN BUARAN, TANGSEL, INDONESIA)

Presented by Fisy Amalia,
Ganesha College of Economics, Indonesia

Search Footer

- Export PDF
- Edit PDF
- Create PDF
- Comment
- Combine Files
- Organize Pages
- Compress PDF
- Redact
- Prepare Form

Convert, edit and e-sign PDF forms & agreements

Free 7-Day Trial

Windows'u etkinleştirme için Ayarlar'a gidin.

Sesi aç Videoyu Başlat Katılımcılar Sohbet Ekran Paylaşımı Kaydı Duraklat/Durdur Ara Odalar Reaksiyonlar Uygulamalar Beyaz Tahtalar Oda dan Çık

INTERNATIONAL ASIAN CONGRESS ON CONTEMPORARY SCIENCES-VII

9:52 / 14:09 Scroll for details

INTERNATIONAL ASIAN CONGRESS ON CONTEMPORARY SCIENCES - VII



CONFERENCE GALLERY

Zoom Toplantı - Hall 3 H3-S3 Haydar KÜPLEMEZ ekranını görüntüleyorsunuz Seçenekleri Görüntüle

Kaydediliyor... Kalan: 06:10:58 Görüntüle

International Asian Congress on Contemporary Sciences – VII
December 09-11, 2022

**IMPORTANCE OF INTERSPECIFIC
RAPESEED FORMS FOR HYBRID
BREEDING**

Emine Yurteri Aysel Özcan Haydar Küplemez Fatih Seyis
Field Crops Department, Faculty of Agriculture,

H3-S2-Dr.Rana Karimova
h-3 observer
Aysun ÇAVUŞOĞLU

Zoom Toplantı - Hall 3 H3-S3 Haydar KÜPLEMEZ ekranını görüntüleyorsunuz Seçenekleri Görüntüle

Kaydediliyor... H3-S3 Haydar KÜPLEMEZ konuşuyor... Kalan: 06:28:37 Görüntüle

RECEP TAYYİP ERDOĞAN ÜNİVERSİTESİ



■ Major Tea Producers
■ Minor Tea Producers

Fig. 2: Countries where tea is grown in the world
Kaynak: http://www.agritech.tnau.ac.in/horticulture/horti_plantation%20crops_tea.html

H3-S2-Dr.Rana Karimova
h-3 observer
ŞEREF MADEN
H3-S3 Haydar KÜPLEMEZ

Windows'u Etkinleştir

Kaydediliyor... Kalan: 05:44:33 Görüntüle

Hall-5 Observer
aakaneren
Hall-5 Observer
Filiz Giray HALL-5
Rifat NERGİZ HALLS

H5 - S2 Ali Çelik
Hall 5 - Hasan YILMAZ
S2-H5-Tokuz Dashdamirova
H5-S2- Kübra Zeyrek

Davut Yılmaz
Hall-5 Emrah ÖGET
Davut Yılmaz
Hall 5-İlkay Yılmaz
hall 5 ferhan şol...

Berna Top
Berna Top

Sesi aç Videoyu Başlat Katılımcılar 13 Sohbet Ekran Paylaşımı Kaydı Duraklat/Durdur Ara Odalar Reaksiyonlar Uygulamalar Odadan Çık



CONFERENCE GALLERY

Kaydediliyor... Kalam: 08:05:09 Görüntüle

H2, Observer

H2-S1: Rinalyn Magtibay H2-S1: John Aldrin Esmara Fevrie Von Asistio S2

H2-S2: Rogayan, Danilo Jr. V. H2-S2: Ferlyn Logronio H2-S1: John Aldrin Esmara

H2-S1: Dr. Daniel Dasig Jr. H2-S1: Rinalyn Magtibay H2-S2: Dr. Mark Anthony N. Polinar

H2-S2: Rogayan, Danilo Jr. V. H2-S2: John Raizen M. Santiago

H2-S2, Dr. Mark...

H2-S2, Dr. Mark Anthony N. Polinar

Katılmıolar (13)

Katılmı bul

- HO H... (Ortak oturum sahibi, ben)
- FV Fevrie Von Asistio S2
- H H2 - S1 - Moderator: Jefferson ...
- AC Aysun ÇAVUŞOĞLU
- (S1-H2)Hao Mehmet Yeşilbaş
- H H2 - S2 - John Raizen M. Santiago
- H2_S2_Ferlyn Logronio
- H2-S1 - John Aldrin Esmara
- H2-S1 Dr. Daniel Dasig Jr.
- HR H2-S1- Rinalyn Magtibay
- HD H2-S2, Dr. Mark Anthony N. Polinar
- H2S2, Rogayan, Danilo Jr. V.
- HALL 2 SESSION 2 --TULIN HÜN...

Kaydediliyor... Kalam: 09:43:27

H2, Observer Pablo M. Latorre H2 - S1 - Moder...

INTERNATIONAL ASIAN CONGRESS ON CONTEMPORARY SCIENCES - VII

December 9-11, 2022
Olongapo City, Philippines
Central Luzon College of Science and Technology

Katılmıolar (13)

Katılmı bul

- HO H... (Ortak oturum sahibi, ben)
- H2-S1-Dr Daniel Dasig Jr- D...
- H2-S1 Dr Daniel Dasig Jr
- CMAA- Mark Anthony N. Polinar
- FV Fevrie Von G. Asistio
- H H2 - S1 - Moderator: Jefferson ...
- HS H2, S1 Observer
- H2_S2_Ferlyn Logronio
- H2-S1 - John Aldrin Esmara
- HR H2-S1- Rinalyn Magtibay
- N nita
- PM Pablo M. Latorre
- S Santiago JohnRaizen

Kaydediliyor... Kalam: 05:31:38 Görüntüle

SESSION-2 | HALL-6 RODOLFO REDA... ekranı görüntüleyorsunuz Seçenekleri Görüntüle

INTERNATIONAL ASIAN CONGRESS ON CONTEMPORARY SCIENCES - VII

December 9-11, 2022
Olongapo City, Philippines
Central Luzon College of Science and Technology
online / In person participation

biohorizons camlog

Bone Level vs Tissue Level implants with Laser-Lok: results from a Clinical Study

Guarnieri R, Reda R, Di Nardo D, Miccoli G, Zanza A, Testarelli L.
Clinical, radiographic and biochemical evaluation of two-piece versus one-piece single implants with a laser-microgrooved collar surface after 5 years of functional loading
Clin Implant Dent Relat Res. 2022;1-7

Dott. Rodolfo Reda

Sevi aç Videoyu Başlat Katılmıolar 4 Sohbet Ekran Paylaşımı Kaydı Duraklat/Durdur Ara Odalar Reaksiyonlar Uygulamalar Odadan Çık

SESSION-2 | HALL-6 RODOLFO REDA

Hall 6 - Observer

Hall 6 - Observer

Ulviyya

Ulviyya

H6-S1-Hall Riza AVCI

INTERNATIONAL ASIAN CONGRESS ON CONTEMPORARY SCIENCES - VII



CONFERENCE GALLERY

The screenshot displays a Zoom conference gallery with several sessions and a presentation slide. The sessions are:

- H-2, Observer**: H2S2 - Moderator Dr. Mariam Dela Cruz, H2, S-2, Samah Bouhazama, H2, S2, Ferlyn Logronio, H2S2, Rogayan, Danilo Jr. V., Hall 2 - Rafaelza Diano, SESSION-2 | HALL-6 RODOLFO R...
- Hall 6 - Observer**: Hall 6 - Observer, H6-S2-Tufail Ahmed, H6-S2-Abdizhai...ulu..., H6-S2-Rodica M..., H6-S2-Rodica Marian..., H6-S1-Hall1 Riza AVCI
- Hall 5 Observer**: Hall-5 Observer, H5-S1 - Hatice KIRAN ÇAKIR

The presentation slide is titled "Consideration of environmental protection aspects as a result of Union subsidies" by Anita Soós. The slide content includes:

Consideration of environmental protection aspects as a result of Union subsidies

Anita Soós

Summary of the presentation content:

1. Consideration of environmental protection aspects as a result of Union subsidies
2. OTHER CONNECTORS
3. A particularly important target area
4. EIA's
5. IMPROVED QUALITY OF THE SYSTEM
6. IMPROVED IMPACTS ASPECT

The slide also features a map of Turkey with various locations marked, and the text "INTERNATIONAL ASIAN CONGRESS ON CONTEMPORARY SCIENCES - VII" and "ARALIK, 2022".

The presentation title is "EVALUATION OF THE DISASTER MANAGEMENT SYSTEM IN TURKEY" and "TÜRKİYE'DEKİ AFET YÖNETİM SİSTEMİNİN DEĞERLENDİRİLMESİ". The presenters are Hatice Kiran Çakır and Rukiye Duygu Çay.

Footnote 1: Trakya Üniversitesi, Mimarlık Fakültesi, Mimarlık Bölümü, 22000, Edirne, Türkiye.
Footnote 2: Trakya Üniversitesi, Mimarlık Fakültesi, Peyzaj Mimarlığı Bölümü, 22000, Edirne, Türkiye.





CONFERENCE GALLERY

Zoom meeting interface for the International Asian Congress on Contemporary Science VII. The meeting title is "INTERNATIONAL ASIAN CONGRESS ON CONTEMPORARY SCIENCE VII" and it is held "Via Zoom Teleconferencing December 9-11, 2022". The meeting duration is 09:21:04. The participant list on the right shows 10 attendees, including H-2, Observer; H2-S2 John Ralzen M. Santiago; H-2, S-2, Samah Bouhazama; Lovelyn Ceralde; H2-S2 - Moderator Dr. Meria...; H2, S-2, Samah Bouhazama; H2, S-2, Ceralde, Lovelyn; H2_S2_Ferlyn Logronio; H2S2, Rogayan, Danilo Jr. V.; Hall 2 - Rafaela Diano; Lovelyn Ceralde; and H2-HS- Santiago, John Ralzen M.

John Ralzen M. Santiago
Education Student, BSEd- Science
ORCID: 0000-0003-4305-3965

COLUMBAN COLLEGE
LONGAPO CITY



Zoom meeting interface for Hall 1. The meeting title is "Zoom Toplantı - Hall 1" and the duration is 07:20:36. The participant list on the right shows 12 attendees, including H-2, Observer; Hall1_Prof. Dr. Gamze GENÇ; Mustafa OZDEN, Ph.D. - Hall-1; aysel arı hall-1 session 2; Caner Kalkan - Hall-1; Feda Aral; H1- S2- Rağr Aydın; H1-S2-Erkan Tetik; Hall-1/Prof.Dr.Mustafa Serdar GENÇ; Sinem Keskin; Tuğba MESELI; and Tuna Murat Bodur.

Hall-1, Observer

Feda Aral

Caner Kalkan - H...

Tuğba MESELI

Sinem Keskin

Zoom meeting interface for Hall 1. The meeting title is "Zoom Toplantı - Hall 1" and the duration is 09:43:58. The participant list on the right shows 8 attendees, including H-2, Observer; H1-S1 Ryan Michael F. Oduc...; Dr. Meriam Dela Cruz; H1-S1 - Nor-ain H. Esmail; H1-S1 ANTONIETTE ALMADEN; H1-S1 Laurice Tolentino; Meral Çelikoğlu (S1 H1); and Moderator: Dr. Froilan Mobo.

Hall-1, Observer

H1-S1 Ryan Michael F. O...

Moderator: Dr. Froila...

H1-S1 Laurice Tolenti...

Zoom users need to stay within the field view of the camera resulting in reduced mobility when sitting down and staring straight ahead for most of the time during videoconferencing (Bailenson, 2018).

Sesi aç **Videoyu Başlat** **Katılımcılar** **Sohbet** **Ekran Paylaşımı** **Kayıt Duraklat/Durdur** **Reaksiyonlar** **Uygulamalar** **Daha fazla** **Odadın Çık**

CONFERENCE PROGRAM



Meeting ID: 861 1920 9032
Passcode: 070707



INTERNATIONAL ASIAN CONGRESS ON CONTEMPORARY SCIENCES-VII

December 09-11, 2022
Olongapo City, Philippines

IMPORTANT, PLEASE READ CAREFULLY

- ❖ To be able to attend a meeting online, login via <https://zoom.us/join> site, enter ID “Meeting ID or Personal Link Name” and solidify the session.
- ❖ The Zoom application is free and no need to create an account.
- ❖ The Zoom application can be used without registration.
- ❖ The application works on tablets, phones and PCs.
- ❖ The participant must be connected to the session 5 minutes before the presentation time.
- ❖ All congress participants can connect live and listen to all sessions.
- ❖ Moderator is responsible for the presentation and scientific discussion (question-answer) section of the session.

Points to Take into Consideration - TECHNICAL INFORMATION

- ◆ Make sure your computer has a microphone and is working.
- ◆ You should be able to use screen sharing feature in Zoom.
- ◆ Attendance certificates will be sent to you as pdf at the end of the congress.
- ◆ Requests such as change of place and time will not be taken into consideration in the congress program.

ÖNEMLİ, DİKKATLE OKUYUNUZ LÜTFEN

- ❖ Kongremizde Yazım Kurallarına uygun gönderilmiş ve bilim kurulundan geçen bildirimler için online (video konferans sistemi üzerinden) sunum imkanı sağlanmıştır.
- ❖ Online sunum yapabilmek için <https://zoom.us/join> sitesi üzerinden giriş yaparak “Meeting ID or Personal Link Name” yerine ID numarasını girerek oturuma katılabilirsiniz.
- ❖ Zoom uygulaması ücretsizdir ve hesap oluşturmaya gerek yoktur.
- ❖ Zoom uygulaması kaydolmadan kullanılabilir.
- ❖ Uygulama tablet, telefon ve PC’lerde çalışıyor.
- ❖ Her oturumdaki sunucular, sunum saatinden 5 dk öncesinde oturuma bağlanmış olmaları gerekmektedir.
- ❖ Tüm kongre katılımcıları canlı bağlanarak tüm oturumları dinleyebilir.
- ❖ Moderatör – oturumdaki sunum ve bilimsel tartışma (soru-cevap) kısmından sorumludur.

Dikkat Edilmesi Gerekenler- TEKNİK BİLGİLER

- ◆ Bilgisayarınızda mikrofon olduğuna ve çalıştığına emin olun.
- ◆ Zoom’da ekran paylaşma özelliğine kullanabilmelisiniz.
- ◆ Kabul edilen bildiri sahiplerinin mail adreslerine Zoom uygulamasında oluşturduğumuz oturuma ait ID numarası gönderilecektir.
- ◆ Katılım belgeleri kongre sonunda tarafınıza pdf olarak gönderilecektir
- ◆ Kongre programında yer ve saat değişikliği gibi talepler dikkate alınmayacaktır

CONGRESS LANGUAGES: Turkish, Azerbaijanian, English, Russian, Arabic

TOTAL NUMBER OF PAPERS: 115
THE NUMBER OF PAPERS FROM TÜRKİYE: 56
OTHER COUNTRIES: 59

Participant 14 Countries

Philippines, Turkey, Azerbaijan, Kyrgyzstan, Indonesia, Pakistan, Romania, Morocco, Ethiopia, Italy, Hungary, UK, Ethiopia, Nigeria, Iran

OPENING CEREMONY

December 9, 2022 - 11:00 a.m. - Philippine Standard time (In Person)

The venue: Central Luzon College of Science and Technology, Olongapo City, Philippines

Froilan D. Mobo, DPA, Ph.D.

Director, IKSAD Insitute Philippines
Head of the Organizing Committee
Opening Remarks

Rene Paulo M. Legaspi, Ph.D.

Senior Vice President
Central Luzon College of Science and Technology
Honorary Chairman
Message

John James A. Larafoster, Ed.D.

Director, Academics, Training, Research and Extension
Message

Meeting ID: 861 1920 9032

Passcode: 070707

10.12.2022 | SESSION-1 | HALL-1



Meeting ID: 861 1920 9032 | Passcode: 070707

Manila Local Time: 14:00 – 16:00 / Ankara Local Time: 09:00 – 11:00

MODERATOR: DR. FROILAN D. MOBO, DPA

Authors	Affiliation	Presentation title
DR. FROILAN D. MOBO, DPA	<i>Philippine Merchant Marine Academy</i>	INVOLVEMENT OF FACULTY IN RESEARCH AND COMMUNITY EXTENSION
Ryan Michael F. Oducado Baby Rose G. Robles Daisy A. Rosano Rome B. Moralista	<i>West Visayas State University, Philippines Guimaras State College, Philippines</i>	Zoom Fatigue and its Predictors among Graduate Students of Teacher Education Program of a State University
Antoniette M. Almaden	<i>Cebu Institute of Technology-University, Philippines</i>	The Service Quality of a Three-Star Hotel as Assessed by the Returning Overseas Filipino (ROF)
Dr. Genalyn P. Lualhati	<i>Batangas State University, Philippines</i>	EMBRACING DIVERSITY: EMPOWERMENT OF FILIPINO PRE-SERVICE TEACHERS FOR INCLUSIVE EDUCATION
LAURICE E. TOLENTINO	<i>Batangas State University, Philippines</i>	Consumer Choice on Korean Restaurant
Jonathan L. Dela Cruz Tessie L. Dela Cruz	<i>Ilocos Sur Polytechnic State College, Philippines</i>	Employment and Employability Characteristics of Graduate School Graduates of a State Higher Education Institution in the Philippines
Zainab A. Abduljalil Nor-ain M. H. Esmail	<i>Mindanao State University, Philippines</i>	INFLUENCE OF ATTITUDES TOWARDS ONLINE LEARNING ON MENTAL HEALTH: AGE AND SEX AS MODERATORS
Eleanor Abarcar- Aler	<i>Jose Rizal University Philippines Eulogio Amang Rodriguez Institute of Science and Technology, Philippines</i>	Effects of Project-based Learning in Teaching Science to Grade School Learners
Meral ÇELİKOĞLU Hacı Mehmet YEŞİLTAŞ Tülin HÜNDÜR Erol TAŞ	<i>Ordu University, Türkiye</i>	BIBLIOMETRIC ANALYSIS OF STUDIES on COMPUTATIONAL THINKING and “UNPLUGGED” LEARNING STRATEGY in SCIENCE EDUCATION
Erol TAŞ Tülin HÜNDÜR Meral ÇELİKOĞLU H. Mehmet Yeşiltaş	<i>Ordu University, Türkiye</i>	Design, Implementation and Evaluation of a Web 2.0 Tool in Teaching Socio-Scientific Subjects: OCTOPUS

10.12.2022 | SESSION-1 | HALL-2



Meeting ID: 861 1920 9032 | Passcode: 070707

Manila Local Time: 14:00 – 16:00 / Ankara Local Time: 09:00 – 11:00

MODERATOR: Jefferson M. Sadera, DPA

Authors	Affiliation	Presentation title
Daniel Dasig Jr C. Ferrer K. Tamayo N. Castro N. Benavides P. Sison Jr	<i>De La Salle University- Dasmariñas, Philippines</i> <i>Jose Rizal University, Philippines</i> <i>Tarlac Agricultural University, Philippines</i> <i>Lyceum Northwestern University, Philippines</i> <i>Pangasinan State University, Philippines</i>	Involvement and Stakeholders Support in the Implementation of Praxis for Advancing Transformational and Participatory Management in Education (PATPaMED) Model among University Academic Officers: A Theory of Reasoned Action Approach
Pablo M. Latorre	<i>De La Salle University- Dasmariñas, Philippines</i>	Flexible Learning Readiness among Basic Education Teachers in Samar Division, Philippines
Ferdinand L. Timbang, CPA, DBA Daniel D. Dasig, Jr, PCpE, PhD, DBA Atty. Rudolph Val F. Guarin, MBA	<i>Miriam College, Quezon City, Philippines</i> <i>De La Salle University- Dasmariñas, Philippines</i>	MEASURING ORGANIZATIONAL EFFICIENCY USING MACHINE LEARNING ALGORITHMS
Jake G. Rumbaoa	<i>Cagayan State University- Lasam, Philippines</i>	AUTOMATED MOCK-UP BOARD
Jefferson M. Sadera, DPA	<i>Columban College, Philippines</i>	PANTAWID PAMILYANG PILIPINO PROGRAM: A CASE STUDY OF INDIGENOUS CHILDREN IN AN ELEMENTARY SCHOOL
Rinalyn G. Magtibay Dr. Rebecca C. Nueva España	<i>Centro Escolar University, Philippines</i> <i>Batangas State University JPLPC Malvar, Philippines</i>	ANALYSIS OF THE EXISTING SOCIO-SCIENTIFIC ISSUES IN THE SCIENCE CURRICULUM OF A STATE UNIVERSITY
Assist. Prof. Fevvie Von Gregorio Asistio	<i>Columban College, Philippines</i>	Language Attitudes of Aeta Teachers in their Local School
John Aldrin D. Esmane	<i>Columban College, Philippines</i>	SATISFACTION LEVEL OF COLLEGE AND GRADUATE SCHOOL STUDENTS ON ACADEMIC INFORMATION MANAGEMENT SYSTEM (AIMS) OF COLUMBAN COLLEGE, INC. TOWARDS IMPROVED SERVICE QUALITY
Tülün HÜNDÜR Prof. Dr. Erol TAŞ Res. Asst. Hacı Mehmet YEŞİLTAŞ Res. Asst. Meral ÇELİKOĞLU	<i>Ordu University, Türkiye</i>	THE FIRST LETTER OF TITLE IS CAPITALIZED INVESTIGATION OF THE STUDIES PUBLISHED BETWEEN 2012-2022 ON THE TEACHERS' CONCERNS ON SCIENCE TEACHING
Res. Asst. Hacı Mehmet YEŞİLTAŞ Prof. Dr. Erol TAŞ Res. Asst. Meral ÇELİKOĞLU Tülün HÜNDÜR	<i>Ordu University, Türkiye</i>	YESTERDAY, TODAY AND TOMORROW OF THE GENIUS HOUSE WORKS

10.12.2022 | SESSION-1 | HALL-3



Meeting ID: 861 1920 9032 | Passcode: 070707

Manila Local Time: 14:00 – 16:00 / Ankara Local Time: 09:00 – 11:00

MODERATOR: Syarif Hidayatullah

Authors	Affiliation	Presentation title
Muhammad Arief Noor	<i>STIE Ganesha, Economy, Jakarta, Indonesia</i>	MARKETING STRATEGY ANALYSIS THROUGH E-COMMERCE, CELEBRITY ENDORSEMENT, PRODUCT QUALITY THAT INFLUENCES PURCHASE DECISIONS ON THE MARKETPLACE IN INDONESIA IN THE DIGITAL ERA
Evilia Sri Yuniar Agus Supriatman	<i>Perjuangan Tasikmalaya University, Indonesia</i>	TRAINING FOR REPORTING AND FINANCIAL MANAGEMENT ON MSMEs IN TASIKMALAYA CITY IN AN EFFORT TO INCREASE FINANCIAL RESILIENCE POST-COVID-19 PANDEMIC
Fajar Sasongko	<i>STIE Ganesha, Economy, Jakarta, Indonesia</i>	IMPACT OF BUSINESS STRATEGY ON FIRM PERFORMANCE THROUGH KNOWLEDGE MANAGEMENT READINESS AND MANAGERIAL COMPETENCIES (A STUDY AT CONSTRUCTION SERVICE COMPANIES IN INDONESIA)
Fisy Amalia Eko Cahyo Mayndarto	<i>STIE Ganesha, Economy, Jakarta, Indonesia Tama Jagakarsa University, Indonesia</i>	THE EFFECTIVENESS OF WOMEN FARMERS' GROUP PROGRAMS AGAINST FOOD INSECURITY DURING THE COVID-19 PANDEMIC (STUDY CASE IN BUARAN, TANGSEL, INDONESIA)
Hendra Candra	<i>STIE Ganesha, Economy, Jakarta, Indonesia</i>	ANALYSIS THE EFFECT OF AGE, EDUCATION AND JOB ON COMMUNITY PERCEPTIONS OF NON-BANK SHARIA HOUSING (STUDY CASE: SOUTH TANGERANG COMMUNITY, BANTEN PROVINCE OF INDONESIA)
Elli Sulistyarningsih	<i>Borobudur University, Indonesia</i>	EFFORTS TO IMPROVE THE QUALITY OF HUMAN RESOURCES IN FACING GLOBAL COMPETITION AFTER COVID 19
Fisy Amalia Idrisi Raliya Putra	<i>STIE Ganesha, Economy, Jakarta, Indonesia</i>	DO THE REGULATION ON AUDITOR TENURE IS POLITICALLY ORIENTED OR EFFICIENCY ORIENTED: AGENCY PERSPECTIVE
Syarif Hidayatullah	<i>STIE Ganesha, Economy, Jakarta, Indonesia</i>	IMPULSIVE BUYING DECISIONS ON LIVE STREAMING SOCIAL COMMERCE
Elli Sulistyarningsih	<i>Borobudur University, Indonesia</i>	Effort Stengthen Technology Skill and Capabilities To Crease HR Productivity and Innovation After Covid 19

10.12.2022 | SESSION-1 | HALL-4



Meeting ID: 861 1920 9032 | Passcode: 070707

Manila Local Time: 14:00 – 16:00 / Ankara Local Time: 09:00 – 11:00

MODERATOR: Muhamad Ridwan

Authors	Affiliation	Presentation title
Ramadani Pardian	<i>STIE Ganesha, Economy, Jakarta, Indonesia</i>	ANALYSIS OF POTENTIAL FOR CULTURAL TOURISM OBJECTS AT SITU LENGKONG PANJALU CIAMIS REGENCY IN THE POST COVID-19 ENDEMIC
Putri Noor Ramayanti	<i>STIE Ganesha, Economy, Jakarta, Indonesia</i>	MANAGEMENT STRATEGY AS TOURISM DEVELOPMENT AT CIUNG WANARA TOURISM OBJECT, CIAMIS WEST JAVA
Patria Adiguna	<i>STIE Ganesha, Economy, Jakarta, Indonesia</i>	SOCIAL ENTREPRENEURSHIP OF LECTURERS IN IMPLEMENTING COMMUNITY SERVICE AS THE IMPLEMENTATION OF THE TRI DHARMA OF HIGHER EDUCATION
Nurhayati Adi Permana	<i>STIE Ganesha, Economy, Jakarta, Indonesia Indraprasta PGRI University, Indonesia</i>	EFFECTIVENESS OF USING DRILL METHOD ON IMPROVING MATHEMATICS LEARNING OUTCOMES IN CLASS X STUDENTS OF SMA NEGERI 99 JAKARTA
Nita Fauziah Oktaviani Evilia Sri Yuniar	<i>Perjuangan Tasikmalaya University, Indonesia</i>	PRODUCT DIVERSIFICATION IN TRADITIONAL FOOD "KOLONTONG" IN CENTRA OPAK, TASIKMALAYA IN MSME RECOVERY EFFORT IN THE POST COVID-19 PANDEMIC
Mohammad Ruvi	<i>STIE Ganesha, Economy, Jakarta, Indonesia</i>	THE INFLUENCE OF EMPOWERMENT AND TRUST TOWARD WORK COMMITMENT OF THE PUBLIC JUNIOR HIGH SCHOOL ADMINISTRATION STAFF IN TEBET DISTRICT, SOUTH JAKARTA
Ika Agustina Melati Puspita Hakim	<i>STIE Ganesha, Economy, Jakarta, Indonesia</i>	DISTANCE LEARNING AND MASTERY OF ACCOUNTING MATERIALS AT STIE GANESHA
Muhamad Ridwan Fuki Lukianto	<i>Sekolah Tinggi Ilmu Ekonomi Ganesha Jakarta, Indonesia</i>	THE EFFECT OF MOTIVATION ON EMPLOYEE PERFORMANCE AT PT. RAJAWALI GARDA NUSANTARA
Yumhi	<i>La Tansa Mashiro College of Economics, Indonesia</i>	THE WORK ABILITY TO PROMOTE THE JOB PERFORMANCE OF MEMBERS OF THE POLICE OF THE REPUBLIC OF INDONESIA (CAUSAL STUDY ON POLICE MEMBERS AT LEBAK POLRES)

10.12.2022 | SESSION-1 | HALL-5



Meeting ID: 861 1920 9032 | Passcode: 070707

Manila Local Time: 14:00 – 16:00 / Ankara Local Time: 09:00 – 11:00

MODERATOR: Sevil AKÇAĞLAR

Authors	Affiliation	Presentation title
Sevil AKÇAĞLAR	<i>Dokuz Eylül University, Türkiye</i>	PHOTOCATALYTIC REMOVAL OF PESTICIDES
Sevil AKÇAĞLAR	<i>Dokuz Eylül University, Türkiye</i>	Removal of a dye using nanocomposite via adsorption
Hatice Kıran Çakır Rukiye Duygu Çay	<i>Trakya University, Türkiye</i>	EVALUATION OF THE DISASTER MANAGEMENT SYSTEM IN TURKEY
Kübra Uyar Sümevra Büşra Şengül Şakir Taşdemir İlker Ali Özkan	<i>Selcuk University, Türkiye</i>	BAYESIAN-BASED HYPERPARAMETER OPTIMIZATION OF CNN MODELS TO CLASSIFY HISTOPATHOLOGICAL IMAGES
Sümevra Büşra ŞENGÜL Kübra UYAR İlker Ali ÖZKAN Şakir TAŞDEMİR	<i>Selcuk University, Türkiye</i>	Performance Evaluation of Pretrained Networks in Classification of Tree Species on Bark Texture
Rukiye Duygu Çay Hatice Kıran Çakır	<i>Trakya University, Türkiye</i>	USING DIFFERENT METHODS IN DETERMINING THE CONTRIBUTION OF OPEN AND GREEN SPACES TO THE URBAN ECONOMY
Musa PEKÖKSÜZ Ali ÖĞÜT İbrahim KILINÇOĞLU Mete KALYONCU	<i>Akdaş Silah A.Ş., Türkiye</i> <i>Konya Technical University, Türkiye</i>	EFFECT OF BARREL TUNER ON SHOOTING ACCURACY
Bahadır Furkan KINACI İsa AVCI	<i>Karabuk University, Türkiye</i>	Investigation of Traffic and Passenger Information Standards Used in Intelligent Transportation Systems
Bahadır Furkan KINACI İsa AVCI	<i>Karabuk University, Türkiye</i>	Security Issues and Precautions on IoT Devices
Assist. Prof. Davut Yılmaz	<i>Ankara Yıldırım Beyazıt University</i>	Comparison of Silt-Induced Wear Maintenance Time in Turbines in Mavi HEPP Project with Empirically Obtained Maintenance Time
Tayfun Uygunoğlu Feyza Çetingül Barış Şimşek Semahat Doruk	<i>Afyon Kocatepe University, Türkiye</i> <i>Çankırı Karatekin University, Türkiye</i>	INVESTIGATION OF THE THERMAL PROPERTIES OF MORTAR LAYERS PRINTED WITH A 3D PRINTER

10.12.2022 | SESSION-1 | HALL-6



Meeting ID: 861 1920 9032 | Passcode: 070707

Manila Local Time: 14:00 – 16:00 / Ankara Local Time: 09:00 – 11:00

MODERATOR: Fatma MEYDANERİ TEZEL

Authors	Affiliation	Presentation title
Halil Rıza Avcı Tulay Özcan	<i>Bursa Central Research Institute of Food and Feed Control, Türkiye Bursa Uludağ University, Türkiye</i>	Investigation of melting behavior of cheese produced with by-products from butter
Ozan Toprakci Rumeysa Betül Aydoğdu Mukaddes Sevval Cetin Hatice Aylin Karahan Toprakci	<i>Yalova University, Türkiye</i>	HEMP-BASED PAPERS
Hatice Aylin Karahan Toprakci Mukaddes Sevval Cetin Aybuke Sultan Demirel Ozan Toprakci	<i>Yalova University, Türkiye</i>	FLEXIBLE STRAIN SENSORS FROM CARBONIZED PISTACHIO SHELL WASTES
Fatma MEYDANERİ TEZEL	<i>Karabük University, Türkiye</i>	The Effect of Extrusion on the Wear and Corrosion Properties of AlMgSi 0.5 Alloy
Fatma MEYDANERİ TEZEL	<i>Karabük University, Türkiye</i>	Microstructure and Mechanical Properties of Alloy 7075-T7351
Emirhan Çalım Fikret Sönmez Yasemin Yıldırım Avcu Eleftherios Iakovakis Eray Abakay Funda Gül Koç Rıdvan Yamaoğlu Egemen Avcu	<i>Kocaeli University, Türkiye Manisa Celal Bayar University, Türkiye Manchester University, UK Sakarya University, Türkiye</i>	INVESTIGATION OF SURFACE AND SUBSURFACE MECHANICAL PROPERTIES OF SHOT PEENED BIOMEDICAL ALLOYS
Gaye Bıyıklı Fatih Ünal	<i>Mersin University, Türkiye</i>	DETERMINATION OF ENERGY SAVINGS WITH OPTIMUM INSULATION THICKNESS FOR DIFFERENT WALL COMPONENTS AND MODELS: HATAY CASE STUDY
Doç. Dr. Mehmet Korkud Aydın	<i>Kırıkkale University, Türkiye</i>	ARAB SOCIALISM AND ITS EFFECTS IN TURKEY
Doç. Dr. Mehmet Korkud Aydın	<i>Kırıkkale University, Türkiye</i>	POLITICAL AND IDEOLOGICAL DISCUSSIONS ABOUT VILLAGE INSTITUTES

10.12.2022 | SESSION-2 | HALL-1



Meeting ID: 861 1920 9032 | Passcode: 070707

Manila Local Time: 16:30 – 18:30 / Ankara Local Time: 11:30 – 13:30

MODERATOR: Gamze GENÇ

Authors	Affiliation	Presentation title
Mustafa ÖZDEN Halil Hakan AÇIKEL Mustafa Serdar GENÇ Kemal KOCA	<i>Erciyes University, Türkiye</i>	RECOGNIZING FLOW EVALUATION ON SURFACE OF NACA0015 AIRFOIL AT VARIOUS ANGLES OF ATTACK
Olçay ALTINTAŞ Erkan TETİK	<i>Iskenderun Technical University, Türkiye Usak University, Türkiye</i>	Flexible Metamaterial-based Electromagnetic Energy Harvesting for WLAN Frequency band
Caner KALKAN Sinem KESKİN Mustafa Serdar GENÇ Berkay AYDOĞAN	<i>Erciyes University, Türkiye</i>	DESIGN OF GLASS REINFORCED RECYCLABLE COMPOSITE WIND TURBINE BLADE AND ANALYSIS
Ayşe Arı	<i>Mersin University, Türkiye</i>	The Relationship between Renewable Energy and Unemployment: Evidence from the Upper Middle Income Countries
Tuna Murat BODUR Osman BODUR Mustafa Serdar GENÇ	<i>Erciyes University, Türkiye</i>	ADDITION OF WAVY STRUCTURE TO FIXED NREL PHASE II WIND TURBINE BLADE AND INVESTIGATION OF OPTIMIZATION PARAMETERS
İbrahim Feda ARAL Ali Rıza DİNÇER	<i>Tekirdağ Namık Kemal University, Türkiye</i>	DEPENDENT ON INDUSTRIAL DENSITY INVESTIGATION OF POSSIBLE GROUND WATER QUALITY CHANGE
İbrahim Feda ARAL Ali Rıza DİNÇER	<i>Tekirdağ Namık Kemal University, Türkiye</i>	INVESTIGATION OF THE CHANGE OF SULFATE, NITRATE, NITRIDE, AMMONIUM, CONDUCTIVITY AND pH PARAMETERS IN WELLS CLOSE TO INDUSTRIAL AND RURAL AREAS
Gamze GENÇ Ashhan BAYYİĞİT Sevde ERTÜRK	<i>Erciyes University, Türkiye</i>	HOURLY ELECTRICITY LOAD FORECASTING IN KAYSERİ WITH MULTIPLE REGRESSION
Gamze GENÇ Hüdayfa GÖK Sevde ERTÜRK	<i>Erciyes University, Türkiye</i>	A COMPUTATIONAL FLOW ANALYSIS THROUGH CATALYTIC CONVERTER FOR DIFFERENT GASES
Rasit AYDIN Bunyamin SAHİN	<i>Selcuk University, Türkiye Hatay Mustafa Kemal University, Türkiye</i>	SURFACTANT-MEDIATED OPTICAL BANDGAP ADJUSTMENT OF NANOSTRUCTURED ZNO THIN FILMS
Tuğba MEŞELİ Hilal DOĞAN Gülşah ELDEN Gamze GENÇ	<i>Erciyes University, Türkiye</i>	EVALUATION OF ENERGY PLANTS IN ENERGY AREAS

10.12.2022 | SESSION-2 | HALL-2



Meeting ID: 861 1920 9032 | Passcode: 070707

Manila Local Time: 16:30 – 18:30 / Ankara Local Time: 11:30 – 13:30

MODERATOR: Dr. Meriam de la Cruz

Authors	Affiliation	Presentation title
JOHN RALZEN M. SANTIAGO	<i>Columban College, Philippines</i>	BARRIERS TO BLENDED LEARNING AMIDST PANDEMIC GRADE 12 STEM STUDENTS AT COLUMBAN COLLEGE, INC.- MAIN
Ferlyn Logronio Anabelle Poloyapoy Emelor Camingawan Joliboy Conol Rosanilio Yagos	<i>Northwestern Mindanao State College of Science and Technology, Philippines J.H. Cerriles State College, Philippines</i>	EFFECTS OF FERMENTED ORGANIC CONCOCTION FROM FISH ENTRAILS AND BANANA STEM ON THE GROWTH AND YIELD PERFORMANCE OF TOMATO (<i>Solanum lycopersicum</i>) PLANT
Rosanilio M. Yagos Chinchin J. Demayo Cesar G. Demayo	<i>J. H. Cerilles State College, Philippines MSU-Iligan Institute of Technology, Philippines</i>	Community structure of freshwater fishes from the Sibugay River, Mindanao, Philippines
Ma. Reina A. Mabeza Nora J. Macasinag Corazon S. Fajardo	<i>College of Business and Public Administration, Philippines</i>	AWARENESS AND ACCEPTABILITY OF CAMARINES NORTE STATE COLLEGE VISION AND MISSION, THE GRADUATE SCHOOL GOAL AND THE OBJECTIVES OF CURRICULAR PROGRAMS
Lovelyn P. Ceralde Darwin P. Paguio Ediric D. Gadia	<i>Gordon College, Philippines</i>	JOB SATISFACTION AND PERFORMANCE OF GORDON COLLEGE EMPLOYEES: A BASIS FOR AN INTEGRATIVE MODEL OF A RESPONSIVE HR POLICY
Hazel B. Baterna Teodolyn Deanne G. Mina Danilo V. Rogayan Jr.	<i>President Ramon Magsaysay State University, Philippines</i>	Digital Literacy of STEM Senior High School Students: Basis for Enhancement Program
Dr. Eleonora E. Claricia Dr. Meriam de la Cruz	<i>De La Salle University- Dasmarias, Philippines</i>	DESIGN, DEVELOPMENT AND ACCEPTABILITY: AN INSTRUCTIONAL MATERIALS FOR COLLEGE TRIGONOMETRY COURSE
Rafaeliza P. Diano Mark Anthony N. Polinar Alein B. Navares Erlyn Ivy O. Rago	<i>Cebu Institute of Technology - University, Philippines</i>	MARKET DEMAND AND INTEREST PROFILING OF CEBU INSTITUTE OF TECHNOLOGY-UNIVERSITY STUDENTS IN THE ONSET OF ONLINE LEARNING
Pr. Chahid SLIMANI Samah BOUHAZAMA	<i>Sidi Mohamed Ben Abdellah University, Morocco</i>	THE COMPANY'S DIGITAL CREATIONS: LEGAL ISSUES AND CHALLENGES

10.12.2022 | SESSION-2 | HALL-3



Meeting ID: 861 1920 9032 | Passcode: 070707

Manila Local Time: 16:30 – 18:30 / Ankara Local Time: 11:30 – 13:30

MODERATOR: Dr. Kərimova Rəna Cabbar kızı

Authors	Affiliation	Presentation title
Elif KARDAŞ Melek YILGIN Neslihan DURANAY	<i>Firat University, Türkiye</i>	TORREFACTION OF HAZELNUT SHELLS, ALMOND SHELLS AND BLENDS
Dr. Kərimova Rəna Cabbar kızı Dr. Tulumbacı Cəfərova Nərminə İlham kızı Ağayeva Asiya Hacı kızı Bayramov Adil Allahyar oğlu Həsənova Xumar Əliövsət kızı	<i>Azerbaijan Medical University</i>	PLASMA AND ITS COMPOSITION, PLATELETS, STRUCTURE, AMOUNT AND FUNCTION
Dr. Kərimova Rəna Cabbar kızı Ağayeva Asiya Hacı kızı Dr. Tulumbacı Cəfərova Nərminə İlham kızı Dr. Məşədiyeva Bayramova Səbinə Ənvər kızı Cəfərova Qumru Kamil kızı	<i>Azerbaijan Medical University</i>	TROMBOSITTEN ZENGİN PLAZMANIN ENDOKRİN SİSTEM ÜZERİNE ETKİLERİ VE MORFOLOJİK ÖZELLİKLERİ
Burcu Gul Ulku Yerebasan Fatih Ahmet Korkak Hande Yuce Yasin Baykalir Tuba Parlak Ak Huseyin Fatih Gul	<i>Firat University, Türkiye</i> <i>Inonu University, Türkiye</i> <i>Munzur University, Türkiye</i> <i>Kafkas University, Türkiye</i>	The Effect of Aloe Vera on Interleukin-6 Levels in Rats Given Aluminium Chloride
Mammadhuseyn Huseynov	<i>Lankaran State University, Azerbaijan</i>	The Genofund of Caucasian persimmon (<i>Diospyros lotus</i> L.) plant in Lankaran-Astara region of Azerbaijan
Funda ERDOĞAN ATAÇ Şeniz ÖZİŞ ALTINÇEKİÇ	<i>Ege University, Türkiye</i> <i>Bursa Uludağ University, Türkiye</i>	EFFECTS OF MATERNAL BEHAVIOURS ON LAMB' SURVIVAL
Aysun CAVUSOĞLU Yusuf GÜVENALTIN Onur ÖKSÜZ Nedret EROL Evren ATMACA	<i>Kocaeli University, Türkiye</i> <i>Ministry of Agriculture and Forestry, Türkiye</i>	Disease-Like Symptoms of Seedlings of <i>Phaseolus vulgaris</i> L. Genotypes Under Salt Stress of Surface Non-Sterilized Seeds
Şeref Maden Gökhan Kerse	<i>Karamanoğlu Mehmetbey University, Türkiye</i> <i>Kafkas University, Türkiye</i>	INVESTIGATION OF GREEN (ENVIRONMENTAL) PRACTICES IN PRIVATE HEALTH INSTITUTIONS WITH JCI ACCREDITATION
Dr. Öğr. Üyesi Emine YURTERİ Araş. Gör. Aysel Özcan AYKUTLU	<i>Recep Tayyip Erdoğan University, Türkiye</i>	IMPORTANCE OF TEA SEED OIL AND POSSIBLE PRODUCTION IN TURKEY

Arař. Gör. Haydar KÜPLEMEZ Prof. Dr. Fatih SEYİS		
Dr. Öğr. Üyesi Emine YURTERİ Arař. Gör. Aysel Özcan AYKUTLU Arař. Gör. Haydar KÜPLEMEZ Prof. Dr. Fatih SEYİS	<i>Recep Tayyip Erdoğan University,</i> <i>Türkiye</i>	IMPORTANCE OF INTERSPECIFIC RAPESEED FORMS FOR HYBRID BREEDING

10.12.2022 | SESSION-2 | HALL-4



Meeting ID: 861 1920 9032 | Passcode: 070707

Manila Local Time: 16:30 – 18:30 / Ankara Local Time: 11:30 – 13:30

MODERATOR: Dr. ilker ibrahim Avşar

Authors	Affiliation	Presentation title
Zehra ALAKOÇ BURMA Caner SALTİK	<i>Mersin University, Türkiye</i>	DIGITAL TRANSFORMATION OF MONEY IN RECREATION BUSINESSES
Recep SIRALI Halime PEHLIVANOĞLU	<i>Tekirdağ Namık Kemal University, Türkiye</i>	LEGAL REGULATIONS REGARDING IMITATION AND ADULTERATION IN HONEY
Ümmühan Mutlu Bahar Aydın Can	<i>Kocaeli University, Türkiye</i>	EVALUATION OF THE POTENTIAL OF AGRICULTURAL FINANCE IN TURKEY IN TERMS OF AGRI-FINTECHS
Bahar Aydın Can Ümmühan Mutlu	<i>Kocaeli University, Türkiye</i>	AN EVALUATION OF CHEMICAL FERTILIZER PRODUCTION, CONSUMPTION, FOREIGN TRADE AND SUPPORTS IN TURKEY
Dr. Afet Suleymanova	<i>Khazar University, Azerbaijan</i>	A new model of the staged organization of content and technologies of pedagogical education and the results obtained
İrem TOPRAK KAYA Prof. Dr. Şener DEMİREL	<i>Fırat University, Türkiye</i>	STUDENT OPINIONS ABOUT GRAMMAR TEACHING ACCORDING TO FLIPPED CLASSROOM MODEL
Taner YILMAZ Bekir TOKAY	<i>Uşak University, Türkiye</i>	Comparison of Time Management of Licensed Swimmers and Non-Sports Adolescents
Dr. Öğr. Üyesi İlker İbrahim Avşar Dr. Dilara Berrak Tarhan	<i>Osmaniye Korkut Ata University, Türkiye</i>	VIRTUAL UNIVERSE IN THE SUPPLY CHAIN (METAVERSE)
Süleyman ŞAHAN	<i>Gaziantep University, Türkiye</i>	GENERATION OF TRUTH IN THE PROCESS OF POLITICAL COMMUNICATION: THE EXAMPLE OF DON'T LOOK UP
Tuğba Otman	<i>Ondokuz Mayıs University, Türkiye</i>	The Role Of Language Teachers In Intercultural Language Teaching

10.12.2022 | SESSION-2 | HALL-5



Meeting ID: 861 1920 9032 | Passcode: 070707

Manila Local Time: 16:30 – 18:30 / Ankara Local Time: 11:30 – 13:30

MODERATOR: Dr. Öğr. Rifat Nergiz

Authors	Affiliation	Presentation title
Dr. Öğr. Rifat Nergiz	<i>Kırgızistan-Türkiye Manas University, Bişkek-Kırgızistan</i>	"Mumiyo" in Kyrgyz Folk Medicine Practices
Ali ÇELİK	<i>Kırgızistan-Türkiye Manas University, Bişkek-Kırgızistan</i>	THE STATUS OF COMMON ROOT VERBS WITH DUAL VOICES IN KYRGYZ AND TURKISH IN KHWAREZM TURKISH
Gizay DAVER Emrah ÖGET	<i>Zonguldak Bülent Ecevit University, Türkiye</i>	Examination of the relationship between government interventions caused by Covid-19 and Borsa Istanbul sub-sector indices with Toda-Yamamoto causality analysis
Tovuz Dashdamirova	<i>Baku State University, Azerbaijan</i>	MODERN SILK ROAD PROJECT AND PARTICIPATION OF AZERBAIJAN
Kübra Zeyrek	<i>Çanakkale On Sekiz Mart University, Türkiye</i>	MORAL REALISM AND LEADERSHIP
Aykut Kan EREN Okan TURK	<i>Mus Alparslan University, Türkiye</i>	EVALUATION OF HATAY STREET DELICACIES IN TERMS OF GASTRONOMY TOURISM
Filiz Giray	<i>Bursa Uludağ University, Türkiye</i>	INCENTIVES WITHIN THE FRAMEWORK OF THE ECONOMIC POLICY OF THE DEFENSE INDUSTRY: AN ASSESSMENT OF TURKEY
İlkay YILMAZ Berrak DELIKANLI-KIYAK	<i>Baskent University, Türkiye Bursa Uludag University, Türkiye</i>	NEXT GENERATION PROBIOTICS
Berna Top Ferhan Şola Erduran	<i>Gazi University, Türkiye</i>	COUPLE FIXED POINT RESULTS OF GERAGHTY TYPE IN ORDERED METRIC SPACE
Hasan Yılmaz	<i>İnönü University, Türkiye</i>	EXAMINATION OF POLITICAL PARTY CHANGE AFTER ELECTION WITHIN THE CONTEXT OF DEMOCRACY

10.12.2022 | SESSION-2 | HALL-6



Meeting ID: 861 1920 9032 | Passcode: 070707

Manila Local Time: 16:30 – 18:30 / Ankara Local Time: 11:30 – 13:30

MODERATOR: Tufail Ahmed

Authors	Affiliation	Presentation title
Rodica-Mariana ION Anca Irina GHEBOIANU Sofia SLAMNOIU-TEODORESCU	ICECHIM, Research Group, Romania Valahia University of Târgoviște, Romania	ARCHAEOLOGICAL STUDY OF TOMIS POTTERY
Anita Soós	Hungarian University of Agricultural and Life Sciences, Hungary	CONSIDERATION OF ENVIRONMENTAL PROTECTION ASPECTS AS A RESULT OF EU SUBSIDIES
Tufail Ahmed	University of Engineering and Technology, Taxila, Pakistan	Assessing the Level of Safety Climate in Science Laboratories in Engineering Universities in Pakistan
Ulviyya Nabizade Gunel Haci Gulmira Nasirova Isa Isayev	National Center of Oncology, Azerbaijan	THE RESULTS OF 3D-CRT ALONE AND CONCURRENT WITH CHEMOTHERAPY IN STAGE III NON-SMALL CELL LUNG CANCER
Rodolfo Reda Alessio Zanza Dario Di Nardo Maurilio D'Angelo Luca Testarelli	Sapienza University of Rome, Italy	CLINICAL, RADIOGRAPHIC, AND BIOCHEMICAL EVALUATION OF TWO-PIECE VERSUS ONE-PIECE SINGLE IMPLANTS WITH A LASER MICROGROOVED COLLAR SURFACE AFTER 5 YEARS OF FUNCTIONAL LOADING
Gulnara KARADENİZ Maksatbek ABDICALİL UULU	Kyrgyz-Turkish Manas University, Kyrgyzstan	OBSTACLES TO LEAN MANUFACTURING: IN THE CASE OF BISHKEK
Sintayehu Assefa Yirga	Hawassa University, Ethiopia	EFFECT OF EMOTIONAL INTELLIGENCE ON EMPLOYEE PERFORMANCE: EVIDENCE FROM GARMENT ENTERPRISES IN ETHIOPIA
Wasiu Abiodun Makinde	Federal Polytechnic, Ilaro, Ogun State, Nigeria	LOCAL GOVERNANCE AND CLIMATE CHANGE MITIGATION IN YEWA SOUTH LOCAL GOVERNMENT AREA, NIGERIA
Vorya Shabrandi	University of Iran	ATTITUDE TO THE SOCIAL UPRISING OF THE "IRANIAN WORLD MOVEMENT WOMEN'S" AND THE "WOMEN'S REVOLUTION" OF THE IRANIAN PEOPLE IN IRAN AND WORLD WITHIN THE FRAMEWORK OF THE NEIL SMELSER THEORY TO FORM A COMPREHENSIVE AND TRANSFORMATIVE SOCIAL MOVEMENT
Peter Olubunmi Olubiyo Lydia Mercy Olubiyo	Adeyemi College Education, Ondo, Nigeria Kogi State Polytechnic, Lokoja, Nigeria,	Institutional Digital Open Access Repositories in Nigerian Universities: Issues and Challenges

INTERNATIONAL ASIAN CONGRESS ON CONTEMPORARY SCIENCES – VII
CONTENTS

INVOLVEMENT OF FACULTY IN RESEARCH AND COMMUNITY EXTENSION	1
FROILAN D. MOBO, DPA	
ZOOM FATIGUE AND ITS PREDICTORS AMONG GRADUATE STUDENTS OF TEACHER EDUCATION PROGRAM OF A STATE UNIVERSITY	2
RYAN MICHAEL F. ODUCAO BABY ROSE G. ROBLES DAISY A. ROSANO ROME B. MORALISTA	
THE SERVICE QUALITY OF A THREE-STAR HOTEL AS ASSESSED BY THE RETURNING OVERSEAS FILIPINO (ROF)	3
ANTONÏETTE M. ALMADEN	
EMBRACING DIVERSITY: EMPOWERMENT OF FILIPINO PRE-SERVICE TEACHERS FOR INCLUSIVE EDUCATION	4
GENALYN P. LUALHATI	
CONSUMER CHOICE ON KOREAN RESTAURANT	5
LAURICE E. TOLENTINO	
EMPLOYMENT AND EMPLOYABILITY CHARACTERISTICS OF GRADUATE SCHOOL GRADUATES OF A STATE HIGHER EDUCATION INSTITUTION IN THE PHILIPPINES	6
JONATHAN L. DELA CRUZ TESSIE L. DELA CRUZ	
INFLUENCE OF ATTITUDES TOWARDS ONLINE LEARNING ON MENTAL HEALTH: AGE AND SEX AS MODERATORS	7
ZAINAB A. ABDULJALIL NOR-AIN M. H. ESMAIL	
EFFECTS OF PROJECT-BASED LEARNING IN TEACHING SCIENCE TO GRADE SCHOOL LEARNERS	8
ELEANOR ABARCAR- ALER	
INVOLVEMENT AND STAKEHOLDERS SUPPORT IN THE IMPLEMENTATION OF PRAXIS FOR ADVANCING TRANSFORMATIONAL AND PARTICIPATORY MANAGEMENT IN EDUCATION (PATPAMED) MODEL AMONG UNIVERSITY ACADEMIC OFFICERS: A THEORY OF REASONED ACTION APPROACH	9
DANIEL DASIG JR C. FERRER K. TAMAYO R. TAMAYO N. CASTRO N. BENAVIDES P. SISON JR	
FLEXIBLE LEARNING READINESS AMONG BASIC EDUCATION TEACHERS IN SAMAR DIVISION, PHILIPPINES	10
PABLO M. LATORRE	
MEASURING ORGANIZATIONAL EFFICIENCY USING MACHINE LEARNING ALGORITHMS	11

INTERNATIONAL ASIAN CONGRESS ON CONTEMPORARY SCIENCES – VII
CONTENTS

FERDINAND L. TIMBANG, CPA, DBA DANIEL D. DASIG, JR, PCPE, PHD, DBA ATTY. RUDOLPH VAL F. GUARIN, MBA	
DESIGN, DEVELOPMENT AND ACCEPTABILITY: AN INSTRUCTIONAL MATERIALS FOR COLLEGE TRIGONOMETRY COURSE	12
ELEONORA E. CLARICIA MERIAM DE LA CRUZ	
AUTOMATED MOCK-UP BOARD	13
JAKE G. RUMBAOA	
PANTAWID PAMILYANG PILIPINO PROGRAM: A CASE STUDY OF INDIGENOUS CHILDREN IN AN ELEMENTARY SCHOOL	14
JEFFERSON M. SADERA, DPA	
ANALYSIS OF THE EXISTING SOCIO-SCIENTIFIC ISSUES IN THE SCIENCE CURRICULUM OF A STATE UNIVERSITY	15
RINALYN G. MAGTIBAY REBECCA C. NUEVA ESPAÑA	
LANGUAGE ATTITUDES OF AETA TEACHERS IN THEIR LOCAL SCHOOL	16
FEVVIE VON GREGORIO ASISTIO	
SATISFACTION LEVEL OF COLLEGE AND GRADUATE SCHOOL STUDENTS ON ACADEMIC INFORMATION MANAGEMENT SYSTEM (AIMS) OF COLUMBAN COLLEGE, INC. TOWARDS IMPROVED SERVICE QUALITY	17
JOHN ALDRIN D. ESMANE	
MARKETING STRATEGY ANALYSIS THROUGH E-COMMERCE, CELEBRITY ENDORSEMENT, PRODUCT QUALITY THAT INFLUENCES PURCHASE DECISIONS ON THE MARKETPLACE IN INDONESIA IN THE DIGITAL ERA	18
MUHAMMAD ARIEF NOOR	
TRAINING FOR REPORTING AND FINANCIAL MANAGEMENT ON MSMES IN TASIKMALAYA CITY IN AN EFFORT TO INCREASE FINANCIAL RESILIENCE POST-COVID-19 PANDEMIC	27
EVILIA SRI YUNIAR AGUS SUPRIATMAN	
EFFECTS OF STRATEGIC MANAGEMENT PRACTICES ON COMPANY PERFORMANCE OF CONSTRUCTION COMPANIES IN INDONESIA	30
FAJAR SASONGKO	
THE EFFECTIVENESS OF WOMEN FARMERS' GROUP PROGRAMS AGAINST FOOD INSECURITY DURING THE COVID-19 PANDEMIC (STUDY CASE IN BUARAN, TANGSEL, INDONESIA)	42
FISY AMALIA EKO CAHYO MAYNDARTO	
ANALYSIS THE EFFECT OF AGE, EDUCATION AND JOB ON COMMUNITY PERCEPTIONS OF NON-BANK SHARIA HOUSING (STUDY CASE: SOUTH TANGERANG COMMUNITY, BANTEN PROVINCE OF INDONESIA)	43
HENDRA CANDRA	
EFFORTS TO IMPROVE THE QUALITY OF HUMAN RESOURCES IN FACING GLOBAL COMPETITION AFTER COVID 19	53

INTERNATIONAL ASIAN CONGRESS ON CONTEMPORARY SCIENCES – VII
CONTENTS

ELLĪ SULĪSTYANĪNGSĪH	
THE INFLUENCE OF THE INDEPENDENCE OF THE AUDIT COMMITTEE ON THE AGENT'S OPPORTUNISTIC BEHAVIOR	54
IDRĪSĪ RALĪYA PUTRA	
IMPULSIVE BUYING DECISIONS ON LIVE STREAMING SOCIAL COMMERCE	73
SYARĪF HĪDAYATULLAH	
EFFORT STENGTHEN TECHNOLOGY SKILL AND CAPABILITIES TO CREASE HR PRODUCTIVITY AND INNOVATION AFTER COVID 19	74
ELLĪ SULĪSTYANĪNGSĪH	
ANALYSIS OF POTENTIAL FOR CULTURAL TOURISM OBJECTS AT SITU LENGKONG PANJALU CIAMIS REGENCY IN THE POST COVID-19 ENDEMIC	88
RAMADANĪ PARDĪAN	
MANAGEMENT STRATEGY AS TOURISM DEVELOPMENT AT CIUNG WANARA TOURISM OBJECT, CIAMIS WEST JAVA	89
PUTRĪ NOOR RAMAYANTĪ	
SOCIAL ENTREPRENEURSHIP OF LECTURERS IN IMPLEMENTING COMMUNITY SERVICE AS THE IMPLEMENTATION OF THE TRI DHARMA OF HIGHER EDUCATION	95
PATRĪA ADĪGUNA	
EFFECTIVENESS OF USING DRILL METHOD ON IMPROVING MATHEMATICS LEARNING OUTCOMES IN CLASS X STUDENTS OF SMA NEGERI 99 JAKARTA	102
NURHAYATĪ ADĪ PERMANA	
PRODUCT DIVERSIFICATION IN TRADITIONAL FOOD” KOLONTONG” IN CENTRA OPAK, TASIKMALAYA IN MSME RECOVERY EFFORT IN THE POST COVID-19 PANDEMI	103
NĪTA FAUZĪAH OKTAVĪANĪ EVĪLĪA SRĪ YUNĪAR	
THE INFLUENCE OF EMPOWERMENT AND TRUST TOWARD THE WORK COMMITMENT OF ADMINISTRATIVE STAFF OF PUBLIC JUNIOR HIGH SCHOOL IN TEBET DISTRICT, SOUTH JAKARTA, INDONESIA	111
MOHAMMAD RUVĪ	
DISTANCE LEARNING AND MASTERY OF ACCOUNTING MATERIALS AT STIE GANESHA	117
IKA AGUSTĪNA MELATĪ PUSPĪTA HAKĪM	
THE EFFECT OF MOTIVATION ON EMPLOYEE PERFORMANCE AT PT. RAJAWALI GARDA NUSANTARA	118
MUHAMAD RĪDWAN DAN FUKĪ LUKĪANTO	
THE WORK ABILITY TO PROMOTE THE JOB PERFORMANCE OF MEMBERS OF THE POLICE OF THE REPUBLIC OF INDONESIA (CAUSAL STUDY ON POLICE MEMBERS AT LEBAK POLRES)	125
YUMHĪ	
PHOTOCATALYTIC REMOVAL OF PESTICIDES	

INTERNATIONAL ASIAN CONGRESS ON CONTEMPORARY SCIENCES – VII
CONTENTS

SEVİL AKÇAĞLAR	126
REMOVAL OF A DYE USING NANOCOMPOSITE VIA ADSORPTION	127
SEVİL AKÇAĞLAR	
TÜRKİYE’DEKİ AFET YÖNETİM SİSTEMİNİN DEĞERLENDİRİLMESİ	128
HATİCE KIRAN ÇAKIR RUKİYE DUYGU ÇAY	
BAYESIAN-BASED HYPERPARAMETER OPTIMIZATION OF CNN MODELS TO CLASSIFY HISTOPATHOLOGICAL IMAGES	139
KÜBRA UYAR SÜMEYRA BÜŞRA ŞENGÜL ŞAKİR TAŞDEMİR İLKER ALİ ÖZKAN	
PERFORMANCE EVALUATION OF PRETRAINED NETWORKS IN CLASSIFICATION OF TREE SPECIES ON BARK TEXTURE	148
SÜMEYRA BÜŞRA ŞENGÜL KÜBRA UYAR İLKER ALİ ÖZKAN ŞAKİR TAŞDEMİR	
KENTSEL AÇIK VE YEŞİL ALANLARIN KENT EKONOMİSİNE KATKISININ BELİRLENMESİNDE FARKLI YÖNTEMLERİN KULLANILMASI	156
RUKİYE DUYGU ÇAY HATİCE KIRAN ÇAKIR	
NAMLU HARMONİK DÜZENLEYİCİSİNİN ATIŞ İSABETLİLİĞİNE ETKİSİ	162
MUSA PEKÖKSÜZ ALİ ÖĞÜT İBRAHİM KILINÇOĞLU METE KALYONCU	
SECURITY ISSUES AND PRECAUTIONS ON IOT DEVICES	171
BAHADIR FURKAN KINACI İSA AVCI	
INVESTIGATION OF TRAFFIC AND PASSENGER INFORMATION STANDARDS USED IN INTELLIGENT TRANSPORTATION SYSTEMS	179
BAHADIR FURKAN KINACI İSA AVCI	
MAVİ HES PROJESİNDE TÜRBİNLERDEKİ SİLT KAYNAKLI AŞINMA BAKIM SÜRESİNİN AMPİRİKSEL ELDE EDİLEN BAKIM SÜRESİYLE KARŞILAŞTIRILMASI	184
DAVUT YILMAZ	
3B YAZICI İLE BASKILANAN HARÇ KATMANLARININ TERMAL ÖZELLİKLERİNİN İNCELENMESİ	202
TAYFUN UYGUNOĞLU FEYZA ÇETİNGÜL BARIŞ ŞİMŞEK SEMAHAT DORUK	
INVESTIGATION OF MELTING BEHAVIOR OF CHEESE PRODUCED WITH BY-PRODUCTS FROM BUTTER	212

INTERNATIONAL ASIAN CONGRESS ON CONTEMPORARY SCIENCES – VII
CONTENTS

HALİL RİZA AVCI TULAY OZCAN	
FLEXIBLE STRAIN SENSORS FROM CARBONIZED PISTACHIO SHELL WASTES	
HATİCE AYLİN KARAHAN TOPRAKCI MUKADDES SEVVAL CETİN AYBUKE SULTAN DEMİREL OZAN TOPRAKCI	213
HEMP-BASED PAPERS	
OZAN TOPRAKCI RUMEYSA BETUL AYDOGDU MUKADDES SEVVAL CETİN HATİCE AYLİN KARAHAN TOPRAKCI	218
THE EFFECT OF EXTRUSION ON THE WEAR AND CORROSION PROPERTIES OF ALMGSI0.5 ALLOY	223
FATMA MEYDANERİ TEZEL	
MICROSTRUCTURE AND MECHANICAL PROPERTIES OF ALLOY 7075-T7351	230
FATMA MEYDANERİ TEZEL	
BİLYALI DÖVÜLMÜŞ BIYOMEDİKAL TİTANYUM ALAŞIMLARININ YÜZEY VE YÜZEY ALTI MEKANİK ÖZELLİKLERİNİN İNCELENMESİ	
EMİRHAN ÇALIM FİKRET SÖNMEZ YASEMİN YILDIRAN AVCU ELEFTHERİOS IAKOVAKİS ERAY ABAKAY4, FUNDA GÜL KOÇ RIDVAN YAMANOĞLU EGEMEN AVCU	236
DETERMINATION OF ENERGY SAVINGS WITH OPTIMUM INSULATION THICKNESS FOR DIFFERENT WALL COMPONENTS AND MODELS: HATAY CASE STUDY	250
GAYE BIYIKLI FATİH ÜNAL	
ARAP SOSYALİZMİ VE TÜRKİYE'DEKİ ETKİLERİ	260
MEHMET KORKUD AYDIN	
KÖY ENSTİTÜLERİ HAKKINDA YAŞANAN SİYASİ VE İDEOLOJİK TARTIŞMALAR	268
MEHMET KORKUD AYDIN	
RECOGNIZING FLOW EVALUATION ON SURFACE OF NACA0015 AIRFOIL AT VARIOUS ANGLES OF ATTACK	
MUSTAFA ÖZDEN HALİL HAKAN AÇIKEL MUSTAFA SERDAR GENÇ KEMAL KOCA	275
FLEXIBLE METAMATERIAL-BASED ELECTROMAGNETIC ENERGY HARVESTING FOR WLAN FREQUENCY BAND	282

INTERNATIONAL ASIAN CONGRESS ON CONTEMPORARY SCIENCES – VII
CONTENTS

OLCAY ALTINTAŞ ERKAN TETİK	
ADDITION OF WAVY STRUCTURE TO FIXED NREL PHASE II WIND TURBINE BLADE AND INVESTIGATION OF OPTIMIZATION PARAMETERS	288
TUNA MURAT BODUR OSMAN BODUR MUSTAFA SERDAR GENÇ	
DESIGN OF GLASS REINFORCED RECYCLABLE COMPOSITE WIND TURBINE BLADE AND ANALYSIS	300
CANER KALKAN SİNEM KESKİN MUSTAFA SERDAR GENÇ BERKAY AYDOĞAN	
HOURLY ELECTRICITY LOAD FORECASTING IN KAYSERİ WITH MULTIPLE REGRESSION	311
GAMZE GENÇ ASLIHAN BAYYİĞİT SEVDE ERTÜRK	
EVALUATION OF ENERGY CROPS IN ENERGY AREAS	318
TUĞBA MEŞELİ HİLAL DOĞAN GÜLŞAH ELDEN GAMZE GENÇ	
A COMPUTATIONAL FLOW ANALYSIS THROUGH CATALYTIC CONVERTER FOR DIFFERENT GASES	324
GAMZE GENÇ HÜDAYFA GÖK SEVDE ERTÜRK	
YENİLENEBİLİR ENERJİ VE İŞSİZLİK ARASINDAKİ İLİŞKİ: ÜST GELİR GRUBU ÜLKELER ÖRNEĞİ	330
AYŞE ARI	
DEPENDING ON INDUSTRIAL DENSITY INVESTIGATION OF POSSIBLE GROUND WATER QUALITY CHANGE	338
İBRAHİM FEDA ARAL ALİ RIZA DİNÇER	
INVESTIGATION OF THE CHANGE OF SULFATE, NITRATE, NITRIDE, AMMONIUM, CONDUCTIVITY AND PH PARAMETERS IN WELLS CLOSE TO INDUSTRIAL AND RURAL AREAS	348
İBRAHİM FEDA ARAL ALİ RIZA DİNÇER	
SURFACTANT-MEDIATED OPTICAL BANDGAP ADJUSTMENT OF NANOSTRUCTURED ZNO THIN FILMS	357
RASİT AYDIN BUNYAMİN SAHİN	
BARRIERS TO BLENDED LEARNING AMIDST PANDEMIC GRADE 12 STEM STUDENTS AT COLUMBAN COLLEGE, INC.- MAIN	366

INTERNATIONAL ASIAN CONGRESS ON CONTEMPORARY SCIENCES – VII
CONTENTS

JOHN RALZEN M. SANTIAGO	
EFFECTS OF FERMENTED ORGANIC CONCOCTION FROM FISH ENTRAILS AND BANANA STEM ON THE GROWTH AND YIELD PERFORMANCE OF TOMATO (SOLANUM LYCOPERSICUM) PLANT	
FERLYN LOGRONIO ANABELLE POLOYAPOY EMELOR CAMINGAWAN JOLIBOY CONOL ROSANILIO YAGOS	367
COMMUNITY STRUCTURE OF FRESHWATER FISHES FROM THE SIBUGAY RIVER, MINDANAO, PHILIPPINES	
ROSANILIO M. YAGOS CHINCHIN J. DEMAYO CESAR G. DEMAYO	368
AWARENESS AND ACCEPTABILITY OF CAMARINES NORTE STATE COLLEGE VISION AND MISSION, THE GRADUATE SCHOOL GOAL AND THE OBJECTIVES OF CURRICULAR PROGRAMSA	
REINA A. MABEZA NORA J. MACASINAG CORAZON S. FAJARDO	369
JOB SATISFACTION AND PERFORMANCE OF GORDON COLLEGE EMPLOYEES: A BASIS FOR AN INTEGRATIVE MODEL OF A RESPONSIVE HR POLICY	
LOVELYN P. CERALDE DARWIN P. PAGUJO EDIRIC D. GADIA	370
DIGITAL LITERACY OF STEM SENIOR HIGH SCHOOL STUDENTS: BASIS FOR ENHANCEMENT PROGRAM	
HAZEL B. BATERNA TEODOLYN DEANNE G. MINA DANILO V. ROGAYAN JR.	371
MARKET DEMAND AND INTEREST PROFILING OF CEBU INSTITUTE OF TECHNOLOGY-UNIVERSITY STUDENTS IN THE ONSET OF ONLINE LEARNING	
RAFAELIZA P. DIANO	372
THE COMPANY'S DIGITAL CREATIONS: LEGAL ISSUES AND CHALLENGES	
CHAHID SLIMANI SAMAH BOUHAZAMA	383
FINDIK KABUĞU, BADEM KABUĞU VE KARIŞIMLARININ TORREFAKSİYONU	
ELİF KARDAŞ MELEK YILGIN NESLİHAN DURANAY	393
PLAZMA VE BİLEŞİMİ, TROMBOSİTLERİ, YAPISI, MİKTARI VE İŞLEVI	

INTERNATIONAL ASIAN CONGRESS ON CONTEMPORARY SCIENCES – VII
CONTENTS

KƏRİMOVA RƏNA CABBAR KIZI TULUMBACI CƏFƏROVA NƏRMİNƏ İLHAM KIZI AĞAYEVA ASİYA HACI KIZI BAYRAMOV ADİL ALLAHYAR OĞLU HƏSƏNOVA XUMAR ƏLİÖVSƏT KIZI	402
TROMBOSİTTEN ZENGİN PLAZMANIN ENDOKRİN SİSTEM ÜZERİNE ETKİLERİ VE MÖRFOLOJİK ÖZELLİKLERİ	
KƏRİMOVA RƏNA CABBAR KIZI AĞAYEVA ASİYA HACI KIZI TULUMBACI CƏFƏROVA NƏRMİNƏ İLHAM KIZI MƏŞƏDİYEVA BAYRAMOVA SƏBİNƏ ƏNVƏR KIZI CƏFƏROVA QUMRU KAMİL KIZI	408
THE EFFECT OF ALOE VERA ON INTERLEUKIN-6 LEVELS IN RATS GIVEN ALUMINIUM CHLORIDE	
BURCU GUL ULKU YEREBASAN FATİH AHMET KORKAK HANDE YUCE YASİN BAYKALİR TUBA PARLAK AK HUSEYİN FATİH GUL	414
THE GENOFUND OF CAUCASIAN PERSIMMON (DIOSPYROS LOTUS L.) PLANT IN LANKARAN-ASTARA REGION OF AZERBAIJAN	415
MAMMADHUSEYN HUSEYNOV	
KUZULARIN YAŞAMA GÜCÜ ÜZERİNE ANNELİK DAVRANIŞLARININ ETKİLERİ	418
FUNDA ERDOĞAN ATAÇ ŞENİZ ÖZİŞ ALTINÇEKİÇ	
DISEASE-LIKE SYMPTOMS OF SEEDLINGS OF PHASEOLUS VULGARIS L. GENOTYPES UNDER SALT STRESS OF SURFACELY NON-STERILIZED SEEDS	
AYSUN CAVUSOĞLU YUSUF GÜVENALTIN ONUR ÖKSÜZ NEDRET EROL EVREN ATMACA	420
JCI AKREDİTASYONLU ÖZEL SAĞLIK KURUMLARINDA YEŞİL (ÇEVRECİ) UYGULAMALARIN İNCELENMESİ	426
ŞEREF MADEN GÖKHAN KERSE	
IMPORTANCE OF INTERSPECIFIC RAPESEED FORMS FOR HYBRID BREEDING	
EMİNE YURTERİ AYSEL ÖZCAN AYKUTLU HAYDAR KÜPLEMEZ FATİH SEYİS	436
IMPORTANCE OF TEA SEED OIL AND POSSIBLE PRODUCTION IN TURKEY	442

INTERNATIONAL ASIAN CONGRESS ON CONTEMPORARY SCIENCES – VII
CONTENTS

EMİNE YURTERİ AYSEL ÖZCAN AYKUTLU HAYDAR KÜPLEMEZ FATİH SEYİS	
REKREASYON İŞLETMELERİNDE PARANIN DİJİTAL DÖNÜŞÜMÜ	
ZEHRA ALAKOÇ BURMA CANER SALTİK	447
BALLARDAKİ TAKLİT VE TAĞŞIŞ İLE İLGİLİ YASAL DÜZENLEMELER	
RECEP SIRALI HALİME PEHLİVANOĞLU	459
TÜRKİYE'DE TARIMSAL FİNANSMANIN AGRİ-FINTECH"LER AÇISINDAN POTANSİYELİNİN DEĞERLENDİRİLMESİ	
ÜMMÜHAN MUTLU BAHAR AYDIN CAN	469
TÜRKİYE'DE KİMYASAL GÜBRE ÜRETİMİ, TÜKETİMİ, DIŞ TİCARETİ VE DESTEKLEMELERİN DEĞERLENDİRİLMESİ	
BAHAR AYDIN CAN ÜMMÜHAN MUTLU	474
PEDAQOJİ TƏHSİLİN MƏZMUN VƏ TEXNOLOGİYALARININ MƏRHƏLƏLİ TƏŞKİLİNİN YENİ MODELİ VƏ ƏLDƏ EDİLMİŞ NƏTİCƏLƏR	
AFET SULEYMANOVA	489
TERS YÜZ EDİLMİŞ SINIF MODELİNE GÖRE YAPILAN DİL BİLGİSİ ÖĞRETİMİNE YÖNELİK ÖĞRENCİ GÖRÜŞLERİ	
İREM TOPRAK KAYA ŞENER DEMİREL	501
COMPARISON OF TIME MANAGEMENT OF LICENSED SWIMMERS AND NON-SPORTS ADOLESCENTS	
TANER YILMAZ BEKİR TOKAY	503
VIRTUAL UNIVERSE IN THE SUPPLY CHAIN (METAVERSE)	
ILKER İBRAHİM AVŞAR DİLARA BERRAK TARHAN	511
SİYASAL İLETİŞİM SÜRECİNDE HAKİKAT ÜRETİMİ: DON'T LOOK UP ÖRNEĞİ	
SÜLEYMAN ŞAHAN	516
THE ROLE OF LANGUAGE TEACHERS IN INTERCULTURAL LANGUAGE TEACHING	
TUĞBA OTMAN	518
KIRGIZ HALK HEKİMLİĞİ UYGULAMALARINDA 'MUMİYO'	
RİFAT NERGİZ	525
KIRGIZCA VE TÜRKÇEDEKİ İKİ SESLİ ORTAK KÖK FİİLLERİN HAREZM TÜRKÇESİNDEKİ DURUMU	
ALİ ÇELİK	528
KOVİD-19 KAYNAKLI DEVLET MÜDAHALELERİ İLE BORSA İSTANBUL ALT SEKTÖR ENDEKSELERİ ARASINDAKİ İLİŞKİLERİN TODA- YAMAMOTO NEDENSELLİK ANALİZİ İLE İNCELENMESİ	
	535

INTERNATIONAL ASIAN CONGRESS ON CONTEMPORARY SCIENCES – VII
CONTENTS

GİZAY DAVER EMRAH ÖGET	
MÜASİR İPƏK YOLU LAYİHƏSİ VƏ AZƏRBAYCANIN İŞTİRAKI	551
TOVUZ DAŞDƏMİROVA	
AHLAKİ GERÇEKÇİLİK VE LİDERLİK KAVRAMI	559
KÜBRA ZEYREK	
HATAY SOKAK LEZZETLERİNİN GASTRONOMİ TURİZMİ AÇISINDAN DEĞERLENDİRİLMESİ	560
AYKUT KAN EREN OKAN TÜRK	
SAVUNMA SANAYİ EKONOMİ POLİTİĞİ ÇERÇEVESİNDE TEŞVİKLER: TÜRKİYE DEĞERLENDİRMESİ	568
FİLİZ GİRAY	
YENİ NESİL PROBİYOTİKLER	578
İLKAY YILMAZ BERRAK DELIKANLI-KIYAK	
COUPLE FIXED POINT RESULTS OF GERAGHTY TYPE IN ORDERED METRIC SPACE	580
BERNA TOP FERHAN ŞOLA ERDURAN	
SEÇİM SONRASI SİYASİ PARTİ DEĞİŞTİRMENİN DEMOKRASİ BAĞLAMINDA İNCELENMESİ	589
HASAN YILMAZ	
ARCHAOMETRIC STUDY OF TOMIS POTTERY	594
RODİCA-MARIANA ION ANCA IRINA GHEBOIANU SOFIA SLAMNOIU-TEODORESCU	
CONSIDERATION OF ENVIRONMENTAL PROTECTION ASPECTS AS A RESULT OF EU SUBSIDIES	595
ANİTA SOÓS	
ASSESSING THE LEVEL OF SAFETY CLIMATE IN SCIENCE LABORATORIES IN ENGINEERING UNIVERSITIES IN PAKISTAN	598
TUFAİL AHMED	
THE RESULTS OF 3D-CRT ALONE AND CONCURRENT WITH CHEMOTHERAPY IN STAGE III NON-SMALL CELL LUNG CANCER	613
ULVİYYA NABİZADE GUNEL HACI GULMİRA NASİROVA ISA ISAYEV	
CLINICAL, RADIOGRAPHIC, AND BIOCHEMICAL EVALUATION OF TWO-PIECE VERSUS ONE-PIECE SINGLE IMPLANTS WITH A LASER MICROGROOVED COLLAR SURFACE AFTER 5 YEARS OF FUNCTIONAL LOADING	614

INTERNATIONAL ASIAN CONGRESS ON CONTEMPORARY SCIENCES – VII
CONTENTS

	<p style="text-align: center;">RODOLFO REDA ALESSIO ZANZA DARIO DI NARDO MAURILIO D'ANGELO LUCA TESTARELLI</p>	
	<p style="text-align: center;">YALIN ÜRETİM UYGULAMASININ ÖNÜNDEKİ ENGELLER: BİŞKEK ÖRNEĞİNDE</p>	616
	<p style="text-align: center;">GULNARA KARADENİZ MAKSATBEK ABDİCALİL UULU</p>	
	<p style="text-align: center;">EFFECT OF EMOTIONAL INTELLIGENCE ON EMPLOYEE PERFORMANCE: EVIDENCE FROM GARMENT ENTERPRISES IN ETHIOPIA</p>	617
	<p style="text-align: center;">SİNTAYEHU ASSEFA YIRGA</p>	
	<p style="text-align: center;">YESTERDAY, TODAY, AND TOMORROW OF THE GENIUS HOUSE STUDIES</p>	618
	<p style="text-align: center;">EROL TAŞ MERAL ÇELİKOĞLU TÜLİN HÜNDÜR</p>	
	<p style="text-align: center;">DESCRIPTIVE CONTENT ANALYSIS FOR ANXIETY STUDIES IN SCIENCE TEACHING</p>	624
	<p style="text-align: center;">TÜLİN HÜNDÜR EROL TAŞ HACI MEHMET YEŞİLTAŞ MERAL ÇELİKOĞLU</p>	
	<p style="text-align: center;">BIBLIOMETRIC ANALYSIS OF STUDIES ON COMPUTATIONAL THINKING AND “UNPLUGGED” LEARNING STRATEGY IN SCIENCE EDUCATION</p>	633
	<p style="text-align: center;">MERAL ÇELİKOĞLU HACI MEHMET YEŞİLTAŞ TÜLİN HÜNDÜR EROL TAŞ</p>	
	<p style="text-align: center;">DESIGN, IMPLEMENTATION AND EVALUATION OF A WEB 2.0 TOOL IN TEACHING SOCIO-SCIENTIFIC SUBJECTS: OCTOPUS</p>	648
	<p style="text-align: center;">EROL TAŞ TÜLİN HÜNDÜR MERAL ÇELİKOĞLU H. MEHMET YEŞİLTAŞ</p>	
	<p style="text-align: center;">WASIU ABIODUN MAKİNDE INSTITUTIONAL DIGITAL OPEN ACCESS REPOSITORIES IN NIGERIAN UNIVERSITIES: ISSUES AND CHALLENGES</p>	657
	<p style="text-align: center;">PETER OLUBUNMI OLUBIYO</p>	658
	<p style="text-align: center;">LYDIA MERCY OLUBIYO</p>	
	<p style="text-align: center;">ATTITUDE TO THE SOCIAL UPRISING OF THE " IRANIAN WORLD MOVEMENT WOMEN'S " AND THE "WOMEN'S REVOLUTION" OF THE IRANIAN PEOPLE IN IRAN AND WORLD WITHIN THE FRAMEWORK OF THE NEIL SMELSER THEORY TO FORM A COMPREHENSIVE AND TRANSFORMATIVE SOCIAL MOVEMENT</p>	668
	<p style="text-align: center;">VORYA SHABRANDI</p>	



INVOLVEMENT OF FACULTY IN RESEARCH AND COMMUNITY EXTENSION

FROILAN D. MOBO, DPA

Ph.D., Assistant Director, Department of Research, Development and Extension

Philippine Merchant Marine Academy, Philippines

ORCID: <https://orcid.org/0000-0002-4531-8106>

Abstract

The academic world is full of scientific surprises because education changes really fast because of the alignment with different sectoral areas. One of the requirements to be called a faculty is to be involved in three areas: Instruction, Research, and Community Extension Involvement; and to have published in a peer-reviewed reputable journal indexed in Scopus, Web of Science, ISI, and other higher impact databases. Most universities are having difficulty requiring their faculty to be actively involved in research and community extension, and several factors are influencing their eagerness to pursue such initiatives.

Keywords: Faculty Involvement, Research, Community Extension



**ZOOM FATIGUE AND ITS PREDICTORS AMONG GRADUATE STUDENTS OF
TEACHER EDUCATION PROGRAM OF A STATE UNIVERSITY**

Ryan Michael F. Oducado

Baby Rose G. Robles

Daisy A. Rosano

Rome B. Moralista

West Visayas State University, Philippines

Guimaras State College, Philippines

Abstract

Videoconference applications gained popularity when online learning became the new way of delivering instruction at all levels of education including graduate programs. However, excessive videoconferencing led to reports of fatigue among its users. Identifying and addressing the factors contributing to the videoconference exhaustion and fatigue experience of graduate students is necessary. This study examined the level of Zoom fatigue and selected associated factors among graduate students. An electronic one-shot survey using the Zoom Exhaustion and Fatigue scale was conducted among 109 graduate students of the College of Teacher Education in the Philippines. Correlation and predictive analysis were performed using the IBM SPSS version 26. Results of the study demonstrated a moderate level of Zoom fatigue with the highest level of fatigue in the general fatigue dimension. Pearson's correlation analysis revealed a significant inverse correlation between attitude toward videoconferencing and Zoom fatigue. Non-verbal mechanisms of mirror anxiety, feeling physically trapped, hyper gaze, and cognitive load in producing non-verbal cues were significantly positively related to Zoom fatigue. Regression analysis revealed that the sense of being physically trapped and cognitive load in producing non-verbal cues remained significant predictors of Zoom fatigue. While videoconferencing supported educational activities and made schooling possible during the global disease outbreak, it is recommended to be mindful of the non-verbal factors contributing to Zoom fatigue.

Keywords: graduate students, teacher education, videoconferencing, Zoom fatigue



THE SERVICE QUALITY OF A THREE-STAR HOTEL AS ASSESSED BY THE RETURNING OVERSEAS FILIPINO (ROF)

Antoniette M. Almaden

Cebu Institute of Technology-University

Abstract

The hotel sector is regarded as one of the most competitive service sectors in the hospitality industry. However, hotels are among those that have been hit hard by the impact of the coronavirus pandemic. From months of lockdown, the hospitality industry has paved the way for the management to establish strategies to adapt to the new normal. This study primarily aims to evaluate the five dimensions of service quality, such as tangibles, responsiveness, assurance, reliability, empathy, and technology, to a three-star hotel in Basak, Lapu-Lapu City. Key performance indicators were also assessed, such as the average daily rate (ADR), revenue per available room (RevPAR), occupancy rate, the average length of stay (ALOS), and online reviews to know how a three-star hotel is performing in catering the returning overseas Filipino (ROF) during the pandemic. A quantitative research approach was used in this study. Out of the 23 respondents, nine provided inputs to specific problems of service dimensions 1 (Tangible) and 5 (Technology) that needed improvement. The Pareto Analysis was used to identify the most critical root cause to deal with and determine which problems need to be prioritized. The results pointed out that the multidimensional construct is noteworthy and facilitates the management to understand practical key attributes to enhance service quality. Provided that the ROFs' preferences change over time; periodic assessments of each service quality dimension should be carried out based on the study context.

Keywords: Hospitality, Service Quality, Quantitative Method, Three-Star Hotel, Cebu



**EMBRACING DIVERSITY: EMPOWERMENT OF FILIPINO PRE-SERVICE TEACHERS
FOR INCLUSIVE EDUCATION**

Genalyn P. Lualhati

Dr., College of Teacher Education, Batangas State University, The National Engineering University,
JPLPC Malvar

Abstract

The increasing diversity in schools requires in-depth understanding of pedagogical approaches to teach diverse populations. This requirement demands Teacher Education Institutions to develop among pre-service teachers' positive attitude towards inclusion and prepare and train them to deliver inclusive practices in a mainstream classroom. This study investigated the attitude towards inclusive education, perceived level of readiness to implement inclusive education and assessment on the effectiveness of teacher education program for inclusive education in terms of collaborative teaching, techniques and strategies and collaborative experiences among pre-service teachers in one state university in Batangas Province, Philippines. Using descriptive-survey as research design with researcher-made questionnaire as tool to gather data, results have shown that the respondents have high positive attitude towards inclusive education. Further, the study also revealed that the respondents have high perception on their readiness to implement inclusive education. Lastly, teacher education program for inclusive education along with collaborative teaching and techniques and strategies were highly effective, while effective only in terms of collaborative experiences. Analyses of the findings afforded the researcher to formulate recommendations that higher authorities may use as inputs in formulating and designing programs to better empower future teachers to embrace diversity.

Keywords: Embracing diversity; pre-service; inclusive education



CONSUMER CHOICE ON KOREAN RESTAURANT

LAURICE E. TOLENTINO

College of Teacher Education, Batangas State University, The National Engineering University,
JPLPC Malvar, Batangas

Abstract

The study was conducted to determine the Consumer Choice on Korean restaurant. Respondents with different sex, age, educational attainment, occupation, monthly income/allowance and religion assessed the Consumer Choice on Korean restaurant in terms of Korean cuisine, service quality, marketing communication and cultural learning. This study also determines if there is significant difference between the profile of the respondents and their assessment when group according to their profile. The researchers used the descriptive method of research which focused on the Consumer Choice on Korean restaurant. The study was composed of 100 respondents from different Korean restaurant in Tagaytay City. The statistical tools utilized were Frequency and Percentage, Weighted mean and Composite mean and Analysis of Variance (ANOVA) and T-test. The study revealed that majority of the respondents who dine in Korean restaurants were from ages 18-39 young adult, female, college graduate, student has an income of 10, 000 and below and Roman Catholic. The customers in five selected Korean restaurants in Tagaytay City considered cuisine, service quality, marketing communication and cultural learning as highly chosen revealed by the grand mean scores of 3.69, 3.63, 3.62 and 3.58 respectively. Furthermore, the result indicates that the researchers direct to reject null hypothesis and have to conclude that there is no significant difference between the consumers' choice on Korean restaurant when they are group according to age, educational attainment, occupation, monthly income and religion. On the other hand, when the same test was conducted on the data considering the sex of the respondents the result goes the other way around the result revealed the null hypothesis is rejected and there is a significant difference between the consumers' choice and the sex of the customers. Based on the findings of the study, the researchers proposed strategies to Korean restaurants to sustain the attractiveness of it to Filipino customers.

Keywords: consumer choice, service quality, marketing communication, cultural learning



EMPLOYMENT AND EMPLOYABILITY CHARACTERISTICS OF GRADUATE SCHOOL GRADUATES OF A STATE HIGHER EDUCATION INSTITUTION IN THE PHILIPPINES

Jonathan L. Dela Cruz

Tessie L. Dela Cruz

Ilocos Sur Polytechnic State College, Associate Professor V, Graduate School, Santa Maria, Ilocos Sur, Philippines

Ilocos Sur Polytechnic State College, Associate Professor V, Graduate School, Tagudin, Ilocos Sur, Philippines

Abstract

Graduates' employability is a vital consideration in assessing higher education institutions' performance. The results of tracer studies serve as a basis to identify graduates' needs to succeed in the workforce. This undertaking aimed to determine the employment and employability characteristics of graduates in graduate school in a state higher education institution in the Philippines. Specifically, it determined the profile of graduates, employment status, employability characteristics, the extent of contribution and applicability of the skills gained, assessed the graduate program offerings, and recommendations to improve the services of the Graduate School. The study used a descriptive research design. The study gathered data from graduates of the two program offerings of the Graduate School. The questionnaire was used to gather the necessary data and analysed using descriptive statistics such as frequency count and percentage, mean, and rank. Based on the results, the graduates enrolled in the College because of school location, faculty qualification, affordable tuition fees, and prospects of career advancement. Graduates are mostly employed in public schools, occupying permanent positions and present employment is relevant to the degree earned. In addition, there is high employability of graduates and a high application of the competencies gained in graduate school. The graduates recommended the offering of terminal programs, the implementation of research-related activities like webinars, seminars, and training, and the improvement of learning facilities. With these conclusions, it is recommended that the existing curriculum shall be reviewed, sustainable professional development of teachers shall be implemented, and research-related activities must be conducted to sustain the relevance and responsiveness of the existing graduate programs and curriculum.

Keywords: Employment, Employability Characteristics, Graduate School, Higher Education



**INFLUENCE OF ATTITUDES TOWARDS ONLINE LEARNING ON MENTAL HEALTH:
AGE AND SEX AS MODERATORS**

Zainab A. Abduljalil

Nor-ain M. H. Esmail

Department of Psychology, Mindanao State University – Marawi City

Abstract

The COVID-19 pandemic outbreak caused education to be ceased for months to prevent the increase of transmission of the virus, which resulted in the temporary closure of schools and universities around the world. Schools were then forced to shift to online learning to address the problems caused by the pandemic. Several studies emerged to grasp the experiences of students during online learning. However, less attention was given to the challenges posed by online learning to teachers. Hence, the aim of this study was to examine the influence of attitude towards online learning on mental health. Additionally, this study investigated the moderating roles of age and sex. The sample consisted of college teachers aged between (21- 61 years old) who were recruited using convenience sampling. Descriptive statistics and linear regression were utilized to gauge the relationships between the variables of interest. Results of this study revealed that attitudes towards online learning significantly influences mental health. Age and sex on the other hand, did not influence the relationship between attitudes towards online learning and mental health. In conclusion, this research emphasizes that attitudes towards online learning was an important factor that influences one's state of well-being.

Keywords: Mental health, online learning, attitude



EFFECTS OF PROJECT-BASED LEARNING IN TEACHING SCIENCE TO GRADE SCHOOL LEARNERS

Eleanor Abarcar- Aler

Teacher-in-Charge, Department of Education Samar Division
Catbalogan City, Samar

Abstract

The study determined the effect of Project-based learning in teaching Science to Grade Six learners. The descriptive-developmental design was used during the development stage. An interest inventory was used as instrument in determining topics and the pedagogy to be used in the development of materials for the course. The experimental method of research was employed using randomized pretest and posttest design during the validation stage. The respondents consisted of 16 learners who were divided into experimental and control groups. Eight learners comprised the experimental group using the project-based pedagogy. The other eight learners were taught in a modular learning approach as the learning modality of Department of Education during this COVID-19 pandemic. The study revealed the effectiveness of project-based learning in teaching Science, hence it is recommended that learning facilitators should make use of project-based pedagogy in other subjects/courses and that further studies be done by conducting experimental validation and empirical investigation.

Keywords: project-based learning, science, project-based pedagogy, pretest, posttest, COVID-19



INVOLVEMENT AND STAKEHOLDERS SUPPORT IN THE IMPLEMENTATION OF PRAXIS FOR ADVANCING TRANSFORMATIONAL AND PARTICIPATORY MANAGEMENT IN EDUCATION (PATPAMED) MODEL AMONG UNIVERSITY ACADEMIC OFFICERS: A THEORY OF REASONED ACTION APPROACH

Daniel Dasig Jr

C. Ferrer

K. Tamayo

R. Tamayo

N. Castro

N. Benavides

P. Sison Jr

De La Salle University- Dasmariñas, Philippines

Jose Rizal University, Philippines

Tarlac Agricultural University, Philippines

Lyceum Northwestern University, Philippines

Pangasinan State University, Philippines

Abstract

The ramification of digital transformation and the COVID-19 pandemic has reshaped all sectors of the service economy including the education sector. For the management to succeed, stakeholders must understand and be actively involved in the design, development, and deployment of the solutions. While vast education management and leadership literature focused on effective and best practices in management, this study presents the perspective of stakeholders' involvement and support and its influence in the implementation of Praxis for Advancing Transformational and Participatory Management in Education (PATPaMED) Model. Using the Theory of Reasoned Action, a validated scale was administered to 20 University Academic Officers, while Partial Least Square Structural Equation Model was applied in the hypotheses testing. The Subjective norms has a direct and significant influence on attitude, while subjective norm and attitude have a positive influence on the behavioral intention to use Praxis for Advancing Transformational and Participatory Management in Education (PATPaMED) Model. Researchers may use the model and examine opportunities in their organization in identifying, designing, and addressing transitional challenges of educational institutions in the digital transformation and COVID-19 pandemic era.

Keywords: Praxis for Advancing Transformational and Participatory Management, participatory management, COVID-19



**FLEXIBLE LEARNING READINESS AMONG BASIC EDUCATION TEACHERS IN
SAMAR DIVISION, PHILIPPINES**

Pablo M. Latorre

Public Elementary School Teacher

Samar Division, Department of Education, Catbalogan City, Samar, Philippines

Abstract

The COVID-19 pandemic has forced the public and private school among countries to shift toward fully-online learning and has reshaped educational practices with the many ramifications implemented. Such move has reshaped the education system by shifting from face-to-face instruction to flexible learning. Flexible learning (FL) seemed to be the most practical as regard to restriction of time, place, and pace of study. This study aimed to assess and determine the flexible learning readiness of the teachers in the classroom process to promote the quality education. The results revealed that teachers preferred a combination of face-to-face and distance learning in which their schools have also chosen such teaching modality. Most of the respondents owned a laptop, desktop computer and smart phone, but only a few have internet connectivity, and were already an “advanced user” to the Email, Facebook, and Facebook Messenger, and further used a ready-made module. Therefore, teachers are flexible enough and ready with any form of educational transformation responsive to the needs of the society. The researcher recommends a strong support from higher authorities in the implementation of the flexible learning.

Keywords: *Flexible Learning, Basic Education Teachers, COVID-19*



MEASURING ORGANIZATIONAL EFFICIENCY USING MACHINE LEARNING ALGORITHMS

Ferdinand L. Timbang, CPA, DBA

Department of Accountancy, School of Business, Entrepreneurship, and Accountancy
Miriam College, Quezon City, Philippines

Daniel D. Dasig, Jr, PCpE, PhD, DBA

Dr. Bienvenido Tantoco, Sr. Graduate School of Business, Jose Rizal University, Mandaluyong City
Associate Professorial Lecturer 6, Graduate Studies, College of Science and Computer Studies
De La Salle University-Dasmaringas, Philippines

Atty. Rudolph Val F. Guarin, MBA

Graduate Studies, College of Science and Computer Studies
De La Salle University-Dasmaringas, Philippines

Abstract

The changing demands of the landscape of the developed and developing economies and the ramifications due to the COVID-19 pandemic and Industry 4.0 have reshaped business industries towards digital transformation. From the era of the digital divide, businesses have transitioned to digital inclusion to maintain their market position and service fulfillment. In this paper, we present the application of Data Envelopment Analysis and Clustering Analysis in measuring organizational and service management efficiencies. Service companies and their core departments were deliberately treated as decision-making units (DMU). The researchers investigated and assessed inputs: process, business model, domain, cultural and organizational transformation; and outputs: proof of digital success, and all-inclusive digital strategy. Based on the results using the two-stage data envelopment analysis (DEA) there has been homogeneity in terms of DMUs' productive efficiency in the areas of process transformation, and business model transformation. The results of this study can be used to inform policy and decision-makers to recalibrate programs of inefficient DMUs. Other studies using businesses analytics and machine learning techniques can be conducted to help the business sector develop a data-driven program to improve the quality, and services management approach in today's remotely operating world.

Keywords: performance efficiency, digital transformation, data envelopment analysis, clustering techniques, decision making unit



**DESIGN, DEVELOPMENT AND ACCEPTABILITY: AN INSTRUCTIONAL MATERIALS
FOR COLLEGE TRIGONOMETRY COURSE**

Eleonora E. Claricia

Dr., Chair, Mathematics Department, College of Liberal Arts, Criminology and Education
Jose Rizal University, Mandaluyong City, Philippines

Meriam de la Cruz

Dr., Eulogio Amang Rodriguez Institute of Science and Technology, Manila, Philippines

Abstract

The curriculum and materials in Mathematics education have been pointed out by many scholars to have been associated with the declining and inferior performance of the student in mathematics. This paper presents the design and development of instructional materials for Trigonometry. The researchers utilized a descriptive-developmental research design. During the development, an iterative development methodology was utilized in the design and development of instructional materials. During the validation stage, the participants' pretest and post-test scores were statistically compared using the t-test. The developed instructional materials were subjected to evaluation based on their Objectives, Contents, Usefulness, Style of instruction, Suitability, Evaluation. The instructional material in Trigonometry resulted in meaningful interaction between teacher and student for an effective teaching-learning process. A very highly acceptable assessment of faculty and experts on the instructional material in Trigonometry based on the objective, content, usefulness, style of instruction, suitability, and evaluation. There is no significant difference in objective, content, usefulness, style of instruction, suitability, and evaluation of the instructional material in Trigonometry as perceived by teachers and experts' respondents. The pretest of the experimental group was rated to be extremely low. With the use of instructional material in Trigonometry, students showed improvement on their post-test assessment task obtaining an average performance. In addition, Moreover, students performed better in their post-test based on the 57.27 difference from the pre-test performance mean score. There is a significant difference between the performance mean scores of the pre-test and post-test of the experimental group.

Keywords: mathematics education, instructional materials, iterative development, pretest, posttest



AUTOMATED MOCK-UP BOARD

Jake G. Rumbaoa

Cagayan State University-Lasam

Abstract

The National Competency (NC) in Levels II and III requires trainings for automotive students-trainees in order to pass the TESDA certification. Studying electrical systems in automotive technology should conform to the manipulative requirements of the Technical Education Skills Development Authority (TESDA).

The Department of Industrial Technology in various institutions across the nation that offer automotive as one of their courses should therefore be made acceptable and compliant to the TESDA National Competency (NC) standard as embodied in the Philippine TVET Qualifications Framework (PTQF). The program offering requires instructors, mock-ups, and pertinent educational materials in automotive technology to facilitate and heighten automotive technology instruction program.

In order to improve the students' manual dexterity and give the teacher a wireless means of evaluating the students' work, it was necessary to design, create, test, and assess an environmentally friendly educational gadget for automotive technology. The Research and Development (R&D) process was chosen by the researcher. Through a survey questionnaire, the descriptive method was introduced to automotive technology instructors from various universities and some automotive technicians in various municipalities of Cagayan as respondents in the study. They rated the fabricated device as an aid in teaching lighting systems as very effective and very acceptable.

Keywords: Automated,Mock-up,Lighting,fabricated



PANTAWID PAMILYANG PILIPINO PROGRAM: A CASE STUDY OF INDIGENOUS CHILDREN IN AN ELEMENTARY SCHOOL

Jefferson M. Sadera, DPA

Columban College, Faculty, College of Arts & Science, and Education, Olongapo City, Philippines

Abstract

The Philippine government implements conditional cash transfer (CCT) program locally known as Pantawid Pamilyang Pilipino Program, or 4Ps, which provides conditional cash grants to the poorest of the poor in the Philippines. Started in 2007, beneficiaries of the program receive cash grants if children stay in school and get regular health check-ups, have their growth monitored, and receive vaccines. However, there are still some factors which prevent indigenous beneficiaries from accessing health and education goods and education goods and services despite the cash grants they are receiving from the government. The researcher looked into these factors through interviews with selected research participants. A Case Study method of research was utilized. There were five (5) participants from an indigenous community in Olongapo City. The following specific research questions were addressed: (1) what is the level of satisfaction of indigenous-participants with 4Ps?; (2) why do the indigenous-participants unable to attend on a regular basis and/or perform well in class?; and, (3) why do the indigenous-participants unable to avail basic immunization and other health services? Based on the interviews, the following conclusions were drawn: (1) Participants are satisfied with the implementation of 4Ps; (2) Indigenous children still do not able to attend school due to family economic status and the distance of the school from their homes; and (3) Indigenous families still rely on alternative medicine which is readily available within their communities rather than going to health centers. To address the issues exposed, the following are recommended: (1) Implementation and evaluation of 4Ps should be improved to achieve better outcomes; (2) Representatives of 4Ps should possess appropriate attitude, sensitivity, and commitment to work with indigenous communities; (3) Alternative Learning System (ALS) for indigenous children should be explored; (4) Education authorities should take into consideration the distance of schools from the homes of indigenous children; (5) Health-related programs should be accessible to the indigenous families; (6) Health authorities should conduct an extensive information dissemination regarding the importance of proper health consultations and activities; (7) Parallel studies should be conducted to verify results of this study.

Keywords: Pantawid Pamilyang Pilipino Program (4Ps), Conditional Cash Transfer (CCT), Indigenous Communities, Case Study, Olongapo City



ANALYSIS OF THE EXISTING SOCIO-SCIENTIFIC ISSUES IN THE SCIENCE CURRICULUM OF A STATE UNIVERSITY

Rinalyn G. Magtibay

Rebecca C. Nueva España

Centro Escolar University, Graduate School, Mendiola, Manila, Philippines

Batangas State University JPLPC Malvar, College of Industrial Technology, Malvar, Batangas

Abstract

In the face of current challenges in societal and environmental concerns, the more science education should focus on reflective thinking on global issues such as the pandemic and climate change, among many others. This study analyzed the occurring socio-scientific issues (SSIs) in the science curriculum of selected courses in a state university in the aspects of the syllabus, instructional material, strategies in teaching, assessment tool, and learning experiences.

Artefact documentary analysis, in-depth one-on-one interviews with the science facilitators, and student surveys for SSIs' occurrence were conducted. Thirty-five (35) syllabi, eighty-five (85) learning materials, nine (9) recorded class video conferences, and fifty-two (52) reflection journals were used for documentary analysis. Seven (7) teacher respondents (TRs) voluntarily participated in interviews while four hundred-seven (407) students responded to surveys. For data gathering, the curriculum guide checklist, guide questions in conducting one-on-one in-depth interviews, and Google Form student survey for the presence of SSIs in the learning experiences were first validated before utilized. To ensure the credibility of the data gathered, validators further analyzed and verified the collected data. Occurring SSIs across all artifacts were carefully analyzed. Illustrative responses of teacher respondents (TRs) in one-on-one interviews and student survey results also unveiled SSIs situations in triangulation with the result of artifact analysis.

A summary of all SSIs occurring on the science curriculum encompassing varied artifacts was established. The level of occurrence with corresponding points was assigned from highly occurred (3 points) to no occurrence at all (0 points). The lowly occurring SSIs (1.43 computed mean score) were the Sustainable Development Goals (SDGs), ethical considerations, and lifelong learning. This was followed by health-related issues (1.77 mean score) and with real-world applications (2.0 mean score). The highly occurring SSI (2.29 mean score) was environmental issues. SDGs, ethical considerations, and lifelong learning, the lowly occurring SSIs, were recommended to be the focus for possible development of learning material dealing with the situation of SSIs to ensure reflective thinking occurred in science teaching.

Keywords: Socio-scientific issues, Science teaching, Science course curriculum analysis



LANGUAGE ATTITUDES OF AETA TEACHERS IN THEIR LOCAL SCHOOL

Fevvie Von Gregorio Asistio

Assistant Professor, College of Arts and Sciences/Education/Nursing
Columban College, Olongapo City, Philippines

Abstract

The paper sought to investigate the perception of the Aeta teachers on usage, preservation and revitalization of their local language. This study used *semi structured interview* using opinion and value questions to gather needed information.

Data gathered revealed that Sitio Mampung is a melting pot of different Aeta communities. Despite of small number of people living in the area, Aeta teachers preferred to use Tagalog language because most of their pupils are not proficient in speaking the Ayta language. In accordance to the Department of Education (DepEd), teachers should adhere to the Mother Tongue-Based Multilingual Education (MTBLE) which intends to follow the L1 of the learners but they are not following this policy due the common language used by most of their learners is Tagalog. Aeta teachers also used indigenized lesson plans for the Aeta learners but their medium of instruction is the Tagalog language. The aeta teachers are engaged in orthography efforts but it is a magnanimous task for them to balance their teaching duties and translating Tagalog words to Ayta Ambala and Ayta Sambali.

Immersion programs to expose the Aytas in their native language is needed in the classrooms. Native aeta teachers should be handling their classes always.

Keywords: Language Attitudes, Ayta, Ethnicity, Language Documentation, Minority, MTBLE, Classroom Instruction, Culture and Heritage



**SATISFACTION LEVEL OF COLLEGE AND GRADUATE SCHOOL STUDENTS ON
ACADEMIC INFORMATION MANAGEMENT SYSTEM (AIMS) OF COLUMBAN
COLLEGE, INC. TOWARDS IMPROVED SERVICE QUALITY**

John Aldrin D. Esmane

Columban College Inc., Faculty, College Department, Olongapo City, Philippines.

Abstract

This study was conducted to describe the level of satisfaction of college and graduate school students in using Academic Information Management System (AIMS) during A.Y. 2021-2022 in terms of usability, reliability, functionality, and efficiency. The researchers used a descriptive design of methodology by using a questionnaire-checklist to scientifically describe the level of students' satisfaction in using AIMS. The respondents of the study were college and graduate school students who are enrolled during A.Y. 2021-2022 wherein the researchers employed a random sampling technique. Generally, the student-respondents were very satisfied with the system. It can be inferred that some areas must be improved specially to enhance the user interface of the system and make simple yet a user-friendly one by creating a portable format when using mobile phones. It was suggested that the system should be accessible all the time. Furthermore, the system should continue in updating the student data to provide accurate information. In addition, there is a need to update the calendar of activities for students' awareness regarding the current and upcoming activities and events in school. The online enrolment system should enhance the process to become more effective than the physical enrolment. The school should provide stable internet service provider for the system to be efficient. The researchers suggested an enhancement plan that can be adapted by the school to increase the level of satisfaction of the students in using AIMS.

Keywords: Management, Academic Information Management System (AIMS), satisfaction level, quality service



MARKETING STRATEGY ANALYSIS THROUGH E-COMMERCE, CELEBRITY ENDORSEMENT, PRODUCT QUALITY THAT INFLUENCES PURCHASE DECISIONS ON THE MARKETPLACE IN INDONESIA IN THE DIGITAL ERA

Muhammad Arief Noor

STIE Ganesha, Economy, Jakarta, Indonesia

Abstract

This study aims to determine empirically the Influence of E-Commerce, Celebrity Endorse, Product Quality, on Purchase Decisions in Marketplace products in Indonesia This research is quantitative research that is associative of causality. The population in this study were customers who bought Marketplace products in Indonesia using the type of sample The non-probability sampling technique chosen, namely by accidental sampling (incidental sampling) is a technique of determining samples based on coincidence, namely anyone who makes a purchase can be used as a sample, if what is seen is as a data source. The data analysis method used is multiple linear regression analysis, with hypothesis tests and tests (R² test, t test and F test). The results of this study show that E-Commerce has a positive effect on purchasing decisions. While celebrity endorse has a positive affect purchasing decisions and product quality has a positive and significant effect on purchasing decisions Test Results F shows that E-Commerce, Celebrity Endorse, product quality affects Profitability, this is shown with a significant value of 0.000.

Keywords: E-Commerce, Celebrity Endorsement, Product Quality, purchasing decision

A. INTRODUCTION

In the all-digital era like today, the business competition that is happening now is very tight, the influence of technology makes business people experience competition. The role of social media in the business world is very important, because social media is one of the main platforms for a business or business to run well and market its products well. Marketing is the process of offering a product or service to meet the needs of consumers. Currently the most needed marketing is marketing in online business. One of them is through internet media (Yuliani et al., 2021).

However, there are still many problems faced by business actors in determining their business targets, such as the number of purchases that have not reached expectations, lack of knowledge about digital marketing, the occurrence of digital gaps, for example, there are still many people who do not understand the importance of social media as the main platform in selling a product. and its impact on purchasing decisions, so that the lack of public knowledge about it makes the product not sold as expected by business actors.

Several factors that can influence purchasing decisions are e-Commerce. The success of an internet business is having a broad market share. This is what makes many people to use the internet as a marketing medium in online business. One type of technology implementation in terms of online business competition is to use electronic commerce (e-commerce). E-commerce is a buying and selling transaction electronically through internet media without having to face to face between the seller and the buyer. The application of E-commerce is one way to market products more easily without having to spend a lot of money (Setyowati & Widjayanti, 2021).

Another factor that can influence purchasing decisions is celebrity endorsement. With the celebrity endorsement, it is easier for entrepreneurs to get customers through promotions reviewed by celebrities and well-known artists so that customers become more confident and make purchasing



decisions. (Pradika & Setiawan, 2022). Usually sellers use endorse services to attract customers by giving some of the seller's superior products for free to endorsement service providers or to celebrities who are endorsed services and pay for these services with an amount of money that has been charged by the celebrity in the hope of getting satisfactory feedback. So that the viewers or followers on the artist's social media are interested in buying products that have been offered through their social media (Pratiwi & Setyaky, 2021).

Other factors that influence purchasing decisions and are taken into consideration by customers are product quality, quality products will increase interest for customers so that they make purchasing decisions. In addition, the quality of the product is able to explain that the product purchased is a superior product made by quality and selected materials and is safe and suitable for consumption or as a reference. By buying quality products, customers can feel comfortable so that a mindset arises to want to make purchases repeatedly (Pradika & Setiawan, 2022).

Some of the descriptions above, the researchers explain some of the variables that the researchers suspect. Therefore, the researcher uses a study entitled "The Influence of E-Commerce, Celebrity Endorsement, Product Quality on Market Place Purchase Decisions in Indonesia to answer the existing problems and prove it empirically.

B. LITERATUR RIVIEW Buying decision

In understanding consumer desires and behavior, there is an influence that underlies consumers so that they are interested or want to make purchasing decisions for a product or brand. At the attitude and behavior of consumers become the influence due to stimuli from the environment that affect the self. The attitudes that are treated by consumers are used to process very complex stimuli, this makes consumers' motivation to purchase products and brands, if someone has high motivation on a particular object, then consumers will be encouraged to behave in mastering the product, on the contrary if the motivation is low, then he will try to avoid the object in front of him. The implication in marketing is for the possibility that the person is interested in buying interest in the product or brand offered by marketing (Yusuf et al., 2021).

Definition of E-Commerce

Online businesses are clients of correspondence organizations and PCs to complete business steps. Online business presents tremendous business openings such as goods transaction and online assistance arrangement as well as revenue development (Rohm and Swamnathan, 2004) For associations, for example, gadget retailers mostly because of their basic and brilliant nature, lower cost and undeniable. level of change and personalization for customers (Park and Baek, 2007).

Web business is one of the important techniques in business today, because web-based business can build proficiency level in an organization. Expanding the number of clients for internet shopping, web-based business has proven to be more confusing than the usual method of working together (Santouris, 2012). Improving the idea of web business organization is seen as one of the key elements driving progress and disillusionment (Yang, 2001) in the usual burden of e-retailers.

Celebrity Endorsement

Explain that celebrity endorsement is an advertising message delivered through popular sources so that it can get more attention from the audience. The advertisement is then intended to make the purchase of the advertised product or service occur (Das et al., 2018). Although it has been done on traditional media, now social media has become a new medium where celebrities can endorse certain brands they want. Celebrity endorsement is also believed to be an effective method in building brand image and increasing sales (Vidyanata et al., 2018).



Product quality

The economic conditions of each country must be increasingly fierce competition. Therefore, every company is required to offer and market products with standards and quality and have more value so that they can be different from other competing products. Product quality is a factor that becomes the initial consideration of a consumer before buying a product. Understanding product quality according to (Aini, 2020) is the ability of a product to perform its functions, this includes overall durability, reliability, accuracy in ease of operation and repair of products and other product attributes. Product quality is a product or service that meets or exceeds customer expectations. Based on the definition according to experts. The term quality is an important point for a company, because the value of the company's reputation, cost reduction, increasing market share to product appearance is the main thing. Product quality is a product characteristic that depends on its ability to satisfy stated or implemented customer needs. A product can be declared quality if it has a high-quality subjective value between one consumer and another (Nasution et al., 2020).

C. RESEARCH METHODS Research Type and Design

Based on the analytical approach, this study uses quantitative methods with an associative approach to causal techniques. The data used is secondary data types of cross-sectional data. The research data was taken from the results of the respondents' answers (the number of customers who made purchases at the Marketplace products in Indonesia through the distribution of questionnaires. In this study the population used was an infinite population, namely the number of populations that were not known. The sample in this study could not If it is determined with certainty how many are used as samples, the sampling method in this study is non-probability sampling

The non-probability sampling technique chosen is accidental sampling (incidental sampling) which is a technique of determining the sample based on chance, that is, anyone who makes a purchase can be used as a sample, if that is seen as a data source.

Research sampling is based on the Lemeshow formula approach, which is as follows:

$$n = \frac{Z^2 \cdot p(1-p)}{d^2}$$
$$n = \frac{1,96 \times 1,96 \cdot 0,5(1 - 0,5)}{0,1 \times 0,1}$$
$$= 94 \text{ responden}$$



D. RESULTS AND DISCUSSION Data Analysis

Tabel 1 Hasil Uji t (Parsial) Coefficients^a

Model		Unstandardized Coefficients		Standardized Coefficients	t	Sig.
		B	Std. Error	Beta		
1 ^c	(Constant)	1,781	2,288		,779	,438
	E-Commerce	,233	,085	,253	2,734	,008
	Celebrity Endorse	,127	,101	,122	1,249	,015
	Kualitas produk	,244	,066	,362	3,696	,000

1. The Tcount value of the E-Commerce variable is 2,777 with a significance value of 0.008 < 0.05. And the tcount value of 2,734 is greater than ttable of 1,661, then H0 is rejected and Ha is accepted. This means that E-Commerce is positively correlated and has a significant effect on purchasing decisions. These results are in line with the first hypothesis which states that E-Commerce has an effect on purchasing decisions.

2. The tcount value of the Celebrity Endorse variable is 2.088 with a significance value of 0.015 < 0.05. The tcount value of 1,249 is smaller than the ttable of 1,661. then H0 is accepted and Ha is rejected. This means that Celebrity Endorse has a positive correlation and has a significant effect on purchasing decisions. This result is in line with the second hypothesis which states that "Celebrity endorsement has an effect on purchasing decisions".

3. The tcount value of the product quality variable is 3,146 with a significance value of 0.000 < 0.05. The tcount value of 3.696 is greater than ttable of 1.661, then H0 is rejected and Ha is accepted. This means that product quality has a positive correlation and has a significant effect on purchasing decisions. This result is also in line with the third hypothesis which states that "product quality influences purchasing decisions".

Uji F

The F test aims to test the significance of all independent variables (E-Commerce, Celebrity Endorse, Product quality) together on the dependent variable (purchase decision).

Table 2

F Test Results (Simultaneous)

1ANOVA^a

Model	Sum of Squares	df	Mean Square	F	Sig.	
1	Regression	81,586	3	27,195	15,149	,000 ^b
	Residual	165,153	92	1,795		
	Total	246,740	95			



Based on the table above, the value of $df = n - 3 - 1$ ($96 - 3 - 1 = 92$) can be obtained so that the F_{table} of 2.71 can be obtained. from the F test, the value of $F_{count} 19,087 > F_{table} 2.71$ with a significant level of $0.000 < 0.05$. So it can be concluded that training, discipline, product quality, together (simultaneously) have a positive and significant influence on purchasing decisions.

Research Discussion 1. Relationship of X1 (E-Commerce) Variables to Y (purchase decisions)

The independent variable E-Commerce Based on the results of the T-test of 2.734 with a significance value of $0.008 < 0.05$. t_{count} value of 2,734 is greater than t_{table} of 1,661 then H_0 is rejected and H_a is accepted. This means that ECommerce is positively correlated and has a significant effect on purchasing decisions. These results are in line with the first hypothesis which states that ECommerce has an effect on purchasing decisions.

This is because E-Commerce can affect the size of consumers because in addition to being practical, easy to access, there are many price promotions. so that purchasing decisions can be achieved so that they choose shopping through e-commerce, this is in line with research conducted by Indra Firdiyansyah (2017) which states that E-Commerce has a positive and significant effect on purchasing decisions.

2. The relationship between the variables X2 (Celebrity Endorse) to Y (purchase decisions)

The t_{count} value of the Celebrity Endorse variable is 1,249 with a significance value of $0.015 < 0.05$. The t_{count} value of 1,249 is smaller than the t_{table} of 1,661. then H_0 is accepted and H_a is rejected. This means that Celebrity Endorse has a positive correlation and has a significant effect on purchasing decisions . These results are in line with the second hypothesis which states that "Celebrity endorsements have an effect on purchasing decisions".

This is because Celebrity Endorse has a significant effect, namely the totality of endorsements made by celebrities, and how to endorse products is very concerned so that it attracts consumers. This is in line with research conducted by Imam Haromain and Heru Suprihadi (2018) which states that Celebrity Endorse has a positive effect and significant to purchasing decisions.

3. Relationship of X3 (product quality) to Y (purchase decision)

Based on the results of the study, the t_{count} value of the product quality variable was 3.696 with a significance value of $0.000 < 0.05$. The t_{count} value of 3.696 is greater than t_{table} of 1.661, then H_0 is rejected and H_a is accepted. This means that product quality has a positive correlation and has a significant effect on purchasing decisions . This result is also in line with the third hypothesis which states that product quality influences purchasing decisions.

This is because the better the quality of the products offered, the more visitors it can attract so that purchasing decisions occur. This is in line with the research conducted by Anggi Setyo Budi (2018) on E-Commerce, Celebrity Endorse, product quality has a positive and significant effect on buying decision.



4. Effect of E-Commerce, Celebrity Endorse, product quality on purchasing decisions.

The Fcount value of 15.149 is obtained with the Ftable value of 2.71 and the significance value of 0.000 at a significant level of 0.05. It can be concluded that $0.000 < 0.05$ and the Fcount value is compared with the Ftable value of $15.149 > 2.71$, then the fourth hypothesis (H4) received. Or simultaneously independent variables affect the decision of the buyer

E. CONCLUSIONS AND RECOMMENDATIONS

Conclusion

Based on the results of research and discussion of the influence, ECommerce, Celebrity Endorse, product quality on purchasing decisions. Marketplace in Indonesia, the researchers can draw the following conclusions:

1. E-Commerce, has a significant effect on online Marketplace decisions in Indonesia, including the good category. This means that in relation to this research, there are several considerations made by consumers when purchasing products, most consumers prefer shopping on e-commerce because apart from being practical, sometimes there are many discount promos available.
2. Celebrity endorsement has a significant effect on purchasing decisions. The higher the value of consumer perceptions of celebrity endorsements, the stronger the consumer's urge to make purchasing decisions. Therefore, in doing endorsements by Celebrity, there are several strategies that must be taken, because consumer perceptions and interest are seen from how serious the celebrity is in doing endorsements, if the endorsement is maximum, consumers will buy Marketplaces in Indonesia that are promoted. has always been an important part of marketing decisions.
3. Product quality has a significant effect on purchasing decisions for Marketplace products in Indonesia in general, including the good category. This means that in relation to this research, because each consumer's decision making will always be different, even every product purchased by a consumer has a different decision making. The consumer decision process in choosing Marketplace products in Indonesia is generally still influenced by environmental factors and personal factors, for example, even though Marketplace products in Indonesia have really been well tested regarding their quality, they can attract buyers so that they no longer have doubts about quality. products that have been tested so that consumers firmly make purchasing decisions.
4. E-Commerce, Celebrity Endorse and Product Quality have a significant effect on purchasing decisions for Marketplace products in Indonesia, these results are in the very good category. This means that simultaneously the higher the ECommerce, Celebrity Endorse, product quality, it will increase the purchasing decisions of Marketplace products in Indonesia.

Suggestion

The suggestions as information and input that researchers can put forward are:

1. For future researchers, in order to get a good model supported by theory and it is recommended to multiply research references that are able to support the topic under study, then the results of this study can be used as match material and references for research, and as consideration for further research. deepen further research and in order to extend the research period so as to obtain better and more accurate results.



2. For companies, as input to evaluate, develop and improve product quality and maintain the good name of the Marketplace in Indonesia that has been used so far so that the company will progress than before and be able to compete with other similar companies better.
3. Consumers who have consumed and used Marketplace products in Indonesia should recommend other consumers as subscriptions.
4. For MSME actors so that this research is able to contribute readings for MSME actors to pay more attention to marketing promotions so that the target market is achieved

BIBLIOGRAPHY

- Aini, F. (2020). Pengaruh Perkembangan E-Commerce dan Infrastruktur Telekomunikasi Terhadap Pertumbuhan Ekonomi Indonesia Tahun 2001 - 2018. *Prosiding Seminar Nasional PBSI-III*, 2(11160840000063), 22–27.
- Akbar, A. R., & Suwitho, S. (2019). Pengaruh Kualitas Produk, Harga dan Strategi Promosi Terhadap Minat Beli. *Jurnal Ilmu Dan Riset*
<http://jurnalmahasiswa.stiesia.ac.id/index.php/jirm/article/view/2605>
- Alhasanah, J., Kertahadi, & Riyadi. (2014). Pengaruh kegunaan, kualitas informasi dan kualitas interaksi layanan web e-commerce terhadap keputusan online (Survei pada Konsumen www.getscoop.com). In *Jurnal Administrasi Bisnis SI Universitas Brawijaya* (Vol. 15, Issue 2). neliti.com.
<https://www.neliti.com/publications/84670/pengaruh-kegunaan-kualitasinformasi-dan-kualitas-interaksi-layanan-web-e-commer>
- Bayu, S. P. (2019). *PENGARUH CELEBRITY ENDORSE, RELATIONSHIP MARKETING KUALITAS PRODUK TERHADAP KEPUTUSAN PEMBELIAN DI MATAHARI DEPARTMENT*
eprints.uwp.ac.id. <http://eprints.uwp.ac.id/id/eprint/1947/>
- Dewi, R. (2019). Pengaruh Kualitas Produk, Citra Merek Dan Celebrity Endorser Terhadap Keputusan Pembelian Smartphone Melalui Minat Beli Sebagai Variabel Intervening. In *Jurnal Administrasi Bisnis Fisipol Unmul* (Vol. 7, Issue 4, p. 409). core.ac.uk. <https://doi.org/10.54144/jadbis.v7i4.2862>
- Galang Nusantara Achmad, & Jannah, S. S. (2021). Pengaruh Fitur E-Commerce Terhadap Keputusan Pembelian Konsumen di Masa Pandemi Covid-19. *Mabny: Journal of Sharia Management and Business*, 1(02), 166–172. <https://doi.org/10.19105/mabny.v1i02.5199>
- Haromain, I., & Suprihhadi, H. (2016). Pengaruh Layanan, Harga, Dan Lokasi Terhadap Kepuasan Pelanggan. *Jurnal Ilmu Dan Riset Manajemen*, 5(5), 1–17.
- Kartika, M., & Ganarsih, R. L. (2019). Analisis e-WOM, online shopping experience dan trust terhadap keputusan pembelian dan kepuasan konsumen e-Commerce Shopee pada mahasiswa In *Jurnal Tepak Manajemen Bisnis* (pp. 1–18). jtmb.ejournal.unri.ac.id.
<https://jtmb.ejournal.unri.ac.id/index.php/JTMB/article/download/7439/6503>
- Kharidah, A. (2018). *Pengaruh celebrity endorse dan kualitas produk terhadap proses keputusan pembelian Oppo (studi pada mahasiswa Prodi SI Manajemen angkatan 2014-2015 FE*
repository.um.ac.id. <http://repository.um.ac.id/32394/>



Kinas, I. A., Alam, R., Manajemen, P. S., Indonesia, U. M., Ekonomi, F., Bisnis, D., & Indonesia, U. M. (2022). Pengaruh Kepercayaan (Trust), Sosial Media Dan Electronic Word of Mouth (E-Wom) Terhadap Partisipasi Pelanggan E-Commerce. *CESJ: Center Of Economic Students ...*, 2(2), 1–18.
<http://jurnal.fe.umi.ac.id/index.php/CESJ/article/view/1285>

LINA SARI SITUMEANG. (2017). Pengaruh Kualitas Pelayanan, Harga Dan Lokasi Terhadap Kepuasan Konsumen Pada Rumah Makan Istana Hot Plate Medan. *Journal of Chemical Information and Modeling*, 53(9), 1689–1699.

Nasution, S. L., Limbong, C. H., & ... (2020). Pengaruh kualitas produk, citra merek, kepercayaan, kemudahan, dan harga terhadap keputusan pembelian pada ecommerce shopee (Survei Pada Mahasiswa S1 (Jurnal Ekonomi, Bisnis
<http://jurnal.ulb.ac.id/index.php/ecobisma/article/view/1528>

Paradis, W. S., Hidayat, Z., & Fauziah, A. (2020). Pengaruh Celebrity Endorse, Kualitas Produk Dan Citra Merk Terhadap Keputusan Pembelian Indomie (Studi Kasus Pada Mahasiswa Stie Widya Gama Lumajang). *Jobman: Journal of Organization and Bussines Management*, 2(4), 171–266.
<https://jkm.itbwigalumajang.ac.id/index.php/jrm/article/view/299>

Pradika, N. D., & Setiawan, M. B. (2022). Pengaruh Celebrity Endorsement, Kualitas Produk, dan Persepsi Harga terhadap Keputusan Pembelian Produk Ms Glow (di Toko Asa Beauty Ms Glow Semarang). *Syntax Literate: Jurnal Ilmiah Indonesia*, 7(1), 2013–2015.
<https://www.jurnal.syntaxliterate.co.id/index.php/syntaxliterate/article/view/5889>

Pratiwi, R., & Setyaky, R. R. (2021). Pengaruh Celebrity Endorse Terhadap Keputusan Pembelian Smartphone Dengan Persepsi Nilai Sebagai Moderasi. In *CAPITAL: Jurnal Ekonomi dan Manajemen* (Vol. 5, Issue 1, p. 58). e-journal.unipma.ac.id. <https://doi.org/10.25273/capital.v5i1.10307>

Rachmat, J. R., & Tresnati, R. (2018). Pengaruh Celebrity Endorsement dan Kualitas Produk terhadap Keputusan Pembelian (Survey di Toko Kiper Bandung). In *Prosiding Manajemen* (Vol. 4, Issue 2). repository.unisba.ac.id. <http://hdl.handle.net/123456789/25738>

Salsabillah, F. M., Syarief, N., & Nastiti, H. (2021). Pengaruh Celebrity Endorsement, Kualitas Produk, Dan Harga Terhadap Keputusan Pembelian Produk Biarnyaman. *Prosiding Biema*, 2(2), 168–187.
<https://conference.upnvj.ac.id/index.php/biema/article/view/1642>

Saswiana. (2020). Pengaruh E-Commerce Terhadap Perilaku Konsumen Dan Keputusan. *Jurnal Ilmiah Manajemen Dan Bisnis*, Volume 5 N(2), 1–17.
<http://journal.undiknas.ac.id/index.php/manajemen/article/view/2453>

Setiawan, R. (2020). Pengaruh Kualitas Produk dan Promosi Terhadap Minat Beli Yang Berdampak Pada Keputusan Pembelian Pada Pelanggan Aprilia Bakery.
In *Jurnal Pemasaran Kompetitif*.
<http://openjournal.unpam.ac.id/index.php/JPK/article/download/5141/3827>

Setyowati, T., & Widjayanti, F. N. (2021). Analisis E-Commerce Terhadap Keputusan Pembelian Produk Olahan Tape Di Kabupaten Jember. *JURNAL MANAJEMEN DAN ...*, 07(02), 62–73.
<http://jurnal.unmuhjember.ac.id/index.php/JMBI/article/view/5933>



- Sugiyono. (2018). Metode Penelitian. In *Metode Penelitian* (pp. 22–34). Anggota Ikatan Penerbit Indonesia (IKAPI).
- Sugiyono. (2019). Bab III METODE PENELITIAN Jenis. *Sugiyono 2019 Hilos Tensados, 1*, 1–476. [http://repository.unpas.ac.id/30085/7/7. BAB III.pdf](http://repository.unpas.ac.id/30085/7/7.BAB%20III.pdf)
- Syaiful Bahri. (2018). Metode penelitian bisnis lengkap dengan teknik pengelolaan data SPSS. *Jurnal Ilmu Dan Riset Manajemen, 4*(1).
- Yuliani, A., Surrahman, H. M., & ... (2021). Tinjauan Fiqih Muamalah terhadap Transaksi Jual Beli Melalui Sistem Pembayaran Cash On Delivery di Toko online Makeuproom Bandung. *Prosiding Hukum*
http://karyailmiah.unisba.ac.id/index.php/hukum_ekonomi_syariah/article/view/31306
- Yulistiani, dwiki erna, Rahma, N., & Hufron, M. (2017). Pengaruh Daya Tarik Iklan dan Kualitas Produk terhadap Keputusan Pembelian dengan Brand Image sebagai variabel intervening. *E-Jurnal Riset Manajemen Prodi Manajemen, 129*(2), 51–69.
<https://ejournal3.undip.ac.id/index.php/djom/article/view/17475>
- Yusuf, Y., Tiauw, A. A., Amin, M., & Mustamin, H. (2021). Peningkatan Keputusan Pembelian Melalui Celebrity Endorsement, Kualitas Produk dan Citra Merek. *Journal of Technopreneurship on Economics and Business Review, 2*(2), 121– 130. <https://doi.org/10.37195/jtebr.v2i2.70>



**TRAINING FOR REPORTING AND FINANCIAL MANAGEMENT ON MSMEs IN
TASIKMALAYA CITY IN AN EFFORT TO INCREASE FINANCIAL RESILIENCE POST-
COVID-19 PANDEMIC**

Evilia Sri Yuniar

Agus Supriatman

Perjuangan Tasikmalaya University, Management, Tasikmalaya, Indonesia

Abstract

The Covid-19 pandemic weakens the resilience of the MSME economy, especially MSME owners who have minimum knowledge of financial statement management. The lack of knowledge of financial management is an obstacle during the Covid-19 pandemic. One of the factors that has made many MSMEs out of business in the midst of the Covid-19 pandemic is because many MSME actors do not understand how to compile reports and manage finances properly. The owners still find it difficult because it is done manually. Due to a lack of financial understanding, some MSME owners combine their personal and business finances so that during the Covid-19 pandemic the owners have to cover their business needs with their personal money. This will have an impact on the chaos of the financial condition of MSMEs. So this service, MSME owners must be given understanding and training on how to properly prepare and manage. This service is carried out as an effort to increase the financial resilience of MSMEs. The results of the posttest conducted to measure financial understanding showed that there was an increase in management knowledge in the MSME businesses that were run. Along with this understanding, MSME owners can run their business better in financial management after the Covid-19 pandemic

Keywords: Financial Management, Preparation of Financial Statements

PRELIMINARY

The growth in the number of MSMEs is currently very large, therefore the MSME sector plays a very important role and has a major contribution in the absorption of labor, from the large number of MSMEs there are not a few MSMEs that cannot maintain their existence due to many factors. The Covid-19 pandemic weakens the resilience of the MSME economy, especially MSME owners who have minimal knowledge of financial statement management. The lack of knowledge of financial management is an obstacle during the Covid-19 pandemic.

Coffee By Karsa is one of the MSME businesses in Tasikmalaya City which has been operating for four years and has not recorded its financial statements properly. Coffee By Karsa is also still mixing business and personal finances so that during the Covid-19 pandemic the owner must cover his business needs with his personal money. This will have an impact on the chaos of the financial condition of MSMEs. So that in this service, MSME owners must be given understanding and training on how to prepare and manage finances well. This service is carried out as an effort to increase the financial resilience of MSMEs.



METHOD

The implementation of this service activity is carried out in three stages. The stages include:

1. Preparation Stage

At this stage the community service group made preparations by selecting MSMEs who still did not understand in preparing financial statements.

2. Socialization Stage.

At this socialization stage, the material for the preparation of financial reports for MSMEs was carried out and the importance of preparing financial reports for MSMEs.

3. Discussion

This stage opens a discussion session between the servant and partners, this discussion contains the problems faced by MSME owners in preparing reports and financial management.

4. Mentoring

This stage provides assistance in the preparation of financial statements from the start of transactions to the preparation of financial statements at the end of the month and assistance in financial management methods, for example in managing cash and several assets.

RESULTS AND DISCUSSION

The problem faced by MSMEs (Cofee By Karsa) is the lack of reporting and financial management. The stages for solving this problem are:

1. The first stage that will be carried out in this community service activity is the preparation stage. The first thing we did was to prepare and conduct a survey again regarding the problems encountered, readjustment of the training time and preparation of materials.

2. Second Stage

At this stage, MSME owners are given an understanding of how important it is to prepare financial statements properly to maximize company value. In addition, MSME owners are introduced to the existing posts on the financial statements so that the preparation of financial statements is calculated correctly. Besides just listening to the material, the owner also shared problems and the service team took notes and looked for solutions. Open a discussion session to explore the financial problems faced.

Picture 1: Submission of Material for the Preparation of Financial Statements



3. Training Phase for Financial Statement Preparation

At this stage, training on the preparation of financial reports for MSME owners and one of the trusted staff is carried out..



Picture 2: Financial Report Preparation Training



4. Control Stage

The final stage in this activity is the control stage. The control stage is seen based on reports that have been prepared previously. MSME owners can see the final financial report so they don't just focus on turnover. Controls in this PKM include financial control in asset purchases and asset management, raw materials and restrictions on capital used for personal needs.

CONCLUSION

Community service activities carried out in one of the MSMEs, namely Cofee By Karsa, do not understand the preparation and management of financial reports. By providing training in community service, MSME owners have a better understanding of financial reports and financial statement management. Cofee By Karsa's financial reports are more structured and asset management is more effective, so that in various conditions, including the Covid-19 pandemic, they are more prepared from the financial side.

References

- Putu Sukma Kurniawan. (2020). Sosialisasi Dan Pelatihan Penyusunan Laporan Keuangan Berbasis Teknologi Informasi Bagi Pelaku Umkm Di Desa Belatungan, Pupuan, Bali. E- Dimas: *Jurnal Pengabdian Masyarakat*.
- Sukmadilaga, C., Sudrajat, Putra, D. M., & dkk. (2019). *INTERNET FINANCIAL REPORTING (Laporan Keuangan Berbasis Teknologi)*. Bandar Lampung: AURA



EFFECTS OF STRATEGIC MANAGEMENT PRACTICES ON COMPANY PERFORMANCE OF CONSTRUCTION COMPANIES IN INDONESIA

Fajar Sasongko

STIE Ganesha, Management, Jakarta, Indonesia

Abstract

The construction industry is very important in the process of building infrastructure such as dams, irrigation buildings, roads, schools and housing. Indonesia's construction industry has grown significantly. The contribution of the construction sector to the country's gross domestic product (GDP) has grown from around 7.07% in 2009 to 10% in 2022 and has driven the growth of Indonesia's building materials and construction industries. Based on World Bank data in 2022, the Indonesian construction services market with a value of IDR 267 trillion is the largest construction market in ASEAN and number 4 in the world. National development priorities are centered on infrastructure, housing, mining and energy development. This year, the Indonesian government experienced an economic growth of 5.44% with the infrastructure sector as the main driving factor. Development for the next few years will be even faster considering that after the Covid-19 pandemic the government is targeting to complete the State Capital (IKN) project.

Although the prospect of the construction industry in Indonesia is currently very promising, many local construction companies are still facing serious difficulties, such as poor performance and low competitiveness. There are two main reasons behind this problem: the environment they face is unfavorable; the other is the lack of strategic direction to improve performance. Furthermore, although strategic management have been widely used by many large construction companies in developed countries, practical examples and empirical studies related to the Indonesian construction industry are still sparse. In addition, research efforts on this topic in developing countries appear to be limited. This has the potential to be one of the inhibiting factors in efforts to increase the competitiveness of Indonesian construction companies.

The purpose of this study is to identify the strategic management practices of construction companies in Indonesia and their impact on company performance. Respondents in this study were taken from construction company employees who are members of the AKI (Indonesian Contractors Association), where they are already at the managerial level. About 28 companies responded to the survey out of a total of 29 previously submitted questionnaires.

Keywords: Indonesia, construction companies, strategic management, company performance

1. INTRODUCTION

As a developing country, Indonesia needs a lot development in infrastructure. Development infrastructure requires strong support from construction industry. Although construction industry plays a very important role in the national life of current economic development, however the development of this industry is running very slow, especially after the Covid-19 pandemic which devastated all aspects of life in Indonesia.

This slow growth is partly due to: lack of industrial efficiency; poor performance results and weaknesses lead to local incompetence construction companies to compete at the international level. In addition, another consequence arising from poor performance is the poor quality of infrastructure, which cannot be utilized properly. This prevents the development process in Indonesia. Therefore,



various efforts and strategies are needed to improve performance and competitiveness in the construction industry so as to accelerate Indonesia's development. On the other hand, construction projects have special characteristics such as high level of fragmentation and full of uncertainty because budget and time constraints, which resulted in frequent changes in project construction.

According to a report published by PricewaterhouseCoopers (2013), the world's construction market at a critical point that 52% of all construction conditions are in emerging markets. This is expected to increase to 63% by 2025, with China and India will contribute most to growth in emerging markets. China beat the United States to become the largest construction market in the world in 2010, and is expected to increase its global power from 18% to 26% by 2025.

1.1. Problem Statement

The problems that often occur in the construction services industry led to a decrease in performance. In general, the problems that often occur in the construction industry in developing countries, are (Sudarto, 2007):

- High imports of capital, labor and materials that can aggravate the balance of payments.
- High currency exchange rates.
- Lack of skills and materials, including managerial and entrepreneurial skills.
- Financial inadequacy and delays in payments.
- Weakness in planning and administration system.
- The dominance of overseas contractors and the lack of capacity of local contractors.
- Lack of planning resulting in irregular job flows, less efficiency and lower quality results.

Indonesia as one of the developing countries experienced some problems that often occur in the construction service industry resulting in low competitiveness, ie.:

- Poor mental attitude and behavior. According to Pranoto (2005), the cause of various problems in the construction and investment sectors in Indonesia is the existence of corruption, collusion and nepotism, monopoly and unfair business competition practices that resulted from moral dilapidation, bad attitude and behavior.
- Lack of competitiveness with foreign contractors due to limited funds and technology. According to Sutjipto (1991), the Indonesian bank contractor's guarantee facility is still frequently rejected by overseas project owners, causing national contractors to struggle to compete with foreign contractors who are able to obtain financially at low interest rates in their country. In addition, due to the limited ability of the government and the private sector to finance the construction of projects with the domestic budget, it causes almost all major projects owned by the government and private financed by foreign loans. By using the excuse that national contractors are inexperienced and technologically capable, foreign investors tend to bring contractors from their countries. As a result, foreign contractors automatically enter together with the coming of foreign loans.

In summary, there are two main reasons behind the low level of profitability and competitiveness, namely: the environment they face is unfavorable, and the lack of strategic direction to improve their competitiveness and performance. Betts and Ofori (1999) argue that in developing countries, large construction companies need to do strategic management and process analysis if they are to survive the attack from foreign construction companies after the adoption of free market economic policies by the government. Small companies will also need a long-term perspective if they want to survive the 'robbery' by big companies, constant changes in public sector development budgets, increased customer needs, and changes in industrial practices.

Although strategic management is now becoming more widely used by large organizations with considerable resources (Price, Ganiev & Newson, 2003), implementation of strategic management for construction companies are still limited (Chinowsky and Meredith, 2000). In addition, the application of strategic management to the Indonesian construction industry is also less serious, and research efforts related to this topic in developing countries appear to be limited.



1.2. Research Objectives

The overall objective of this research is to find solutions to the main issue "How to formulate the influence of strategic management in improving the performance of construction service companies in Indonesia?" This study targets construction service companies in Indonesia which is currently regulated by the Law of the Republic of Indonesia no. 2 Year 2017 (in lieu of Law of the Republic of Indonesia No. 18 of 1999). Definition of construction services is a consultancy services for construction and / or construction work, which in the form of:

- Construction consultancy is an overall service or part of activity which includes assessment, planning, design, supervision, and management of construction of a building. A construction consultancy including general (architecture, engineering, integrated engineering, and landscape architecture and regional planning) and specialists (scientific and technical consultancy, and technical testing and analysis);
- Construction work is the whole or part of the activities which include the construction, operation, maintenance, dismantling, and rebuilding of a building. A construction work including general (civil and buildings) and specialists (installation, special construction, prefabricated construction, completion of buildings, and equipment rental).
- Integrated construction work is classified according to civil and buildings, including design, engineering, procurement, and implementation work.

To achieve the objectives of the study in accordance with this set target, the following specific objectives are formulated:

1. Identify strategic management of construction companies in Indonesia.
2. To know the level of implementation of strategic management in construction companies in Indonesia in terms of achievement of its performance.
3. To study the impact of the implementation of strategic management of this construction company on the performance of the company.

1.3. Strategic Management

Strategic management is the process of formulating, implementing and evaluating decisions about the future direction of the organization. There are many definitions of strategic management defined by strategic management experts in their writing. For example: Chandler (1962), Wheelen and Hunger (1984), Certo and Peter (1991), Viljoen and Dann (2000), Kerzner (2001), and more. Today, strategic management has become an important part of a modern management. Refer to Stahl and Grigsby (1992), strategic management is a crucial role in all of organizations. This allows an organization to be more proactive rather than being reactive in shaping its own future, to start and influence activities and to exert control over its own activities (David, 2003). The benefit of strategic management is to help organizations make better strategies through a more systematic, logical, and rational approach to strategic choice (David, 1991).

According to Carpenter & Sanders (2009), the strategic management process involves four distinct elements: environmental scanning, strategy formulation, strategy implementation, and strategy evaluation. Furthermore, the strategic management process is an ongoing process of anticipating, recognizing, evaluating, completing, controlling, documenting, and learning from previous experiences to maintain the viability of the project or the company as a whole (Ibbs, Wong and Louie, 2001; Arain and Low, 2005). Johnson, Scholes and Whittington (2008), emphasize that organizations that use strategy seek to overcome competitors and other external influences by configuring and using their superior resources to meet the expectations of stakeholders. Dye & Sibony (2007) explains that a good approach to strategic management processes is a key factor of success and growth within the organization and contributes to a higher level of satisfaction among those involved in the process.



1.4. Strategic Management in Construction Industry

According to Bryson (2010), strategic management can be considered as a structured process involving all lines of organization with the main objective to map the organization's mission, outline a shared vision of the direction of the organization and, in particular, involving the structure of long-term goals and objectives that include financial growth and stakeholder appreciation while maintaining moral and ethical considerations in the decision-making process.

According to Nag, et al. (2007), this definition includes major initiatives taken by senior management in utilizing organizational resources to improve performance, while reducing external environmental stress. This will create a correlation between strategic management and strategy. As Johnson, Scholes and Whittington (2007), in his book *Exploring Corporate Strategy* (8th Edition), the strategy provides vision and visual scope that generate profit, both in operational efficiency and financial targets and sustains the organization's mission and vision in challenging environments. The implementation of strategic management in the construction industry is possible to achieve better performance. Technological, communications and market advancements essentially change the global perspective of time, distance, and socioeconomic boundaries. With the advent of industry knowledge and innovation, the construction industry has made tremendous dynamic progress as design progress and project construction work in almost all project sites, thus having a direct impact on competition and market share. So this requires the implementation of strategic management practices within construction companies while considering the use of expert systems, new market expansions and the use of information technology. According to Yates (2007), construction companies must shift from traditional business approaches in their local operating conditions to a global perspective approach characterized by benchmarks and innovative processes to improve efficiency. As described by Blair (2009), construction companies are increasingly required to review and revise their strategies in order to capitalize on volatile markets.

1.5. Indonesia Construction Industry

In developing countries like Indonesia, the construction industry plays an important role in the development process to produce infrastructure such as dams, irrigation buildings, highways, schools and housing. The ability of the construction sector can not only improve the standard of living but also can obtain cost efficiency, time and quality of work and self-esteem as a nation (Chiragi, 2000; Trigunaryah, 2006 and Todaro, 2011).

Indonesia's construction industry has grown significantly, driven by the rapid growth of the property / real estate market in the country, increased private investment and government spending. The contribution of the construction sector to the gross domestic product (GDP) of the country has grown from about 7.07% in 2009 to 13% by 2021 and has encouraged the growth of Indonesia's building and construction industry. The development of the construction sector is followed by an increase in employment in the sector (Quarter IV Final Report, Bappenas).

This rapid growth is also encouraged by the MEA or AEC (ASEAN Economic Community) which is an agreement as a form of strengthening in various sectors, especially for the defense of global “shocks”. The implementation of this policy is similar to the Free Trade Area (FTA), but it is still within the ASEAN region. This policy arose because of the increasing need for bilateral cooperation in strengthening ASEAN countries from external product attacks. In addition, growth in the construction sector is also driven by the strengthening of the middle class and the impact of this year's tax amnesty policy.

Although Indonesia's construction market is experiencing rapid growth, State-Owned Enterprises (SOEs) consisting of 14 “Karya” companies, only absorb 10% of the total value of engineering, procurement, and construction (EPC). 70% of the EPC market is dominated by foreign companies, and another 20% by private national companies. Current figures show that the majority of foreign construction companies are from Japan, Europe and China. According Pamulu (2009), there are two



main reasons why this happens is the low competitiveness, institutional factors and strategic management factors.

Regarding the important role of construction services in growing the Indonesian economy and amid the onslaught of foreign construction services, we are interested to raise the topic of how appropriate strategic management in the construction industry and the influence of these strategies on company performance.

1.6. Conceptual Framework

A conceptual framework is used to outline or the preferred approach to an idea. It highlights the independent variable and also shows the dependent variable which is also the outcome. The dependent variable is the company performance and the independent variable is external environment context, strategic management practices, and internal organizational context.

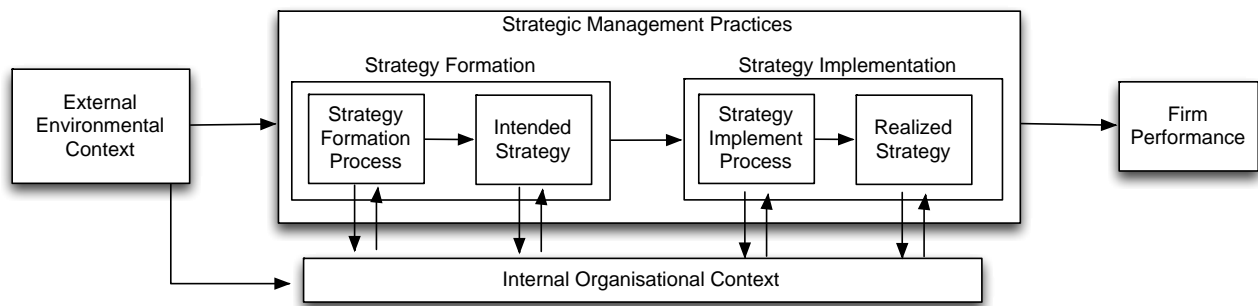

Figure 1. Conceptual Framework

2. METHODOLOGY

This study uses survey methods to collect data where the questionnaire is distributed as the primary source for obtaining primary data. Questionnaires are distributed directly to the construction companies that are members of AKI or ICA (Indonesian Contractor Association) operating throughout Indonesia. Of the 90 companies that are members of AKI (as per 2016 data), we are distributing questionnaires to 30 selected companies already considering the composition of national companies, state-owned companies (SOEs) and FDI (Foreign Direct Investment) companies. From 30 questionnaires, all or 100% of respondents were willing to fill out and return the questionnaire. The questionnaire is divided into three main sections covering: respondent background, strategic management practices, and links to company performance including winning contracts and profit.

The collected data were analyzed by using frequency analysis, cross tabulation and correlation analysis. Frequency is used to present the distribution of variables. Cross tabulation is used to analyze information about the relationship of two variables whereas correlation is used to measure the linear relationship between two variables.

The formulation of the questionnaire was conducted by interviewing the professionals in the construction industry in Indonesia. In the interview, the researcher gives an introduction to the study, including research objectives, questionnaire design, and expected results. Later, the interviewee was invited to review the questionnaire and give them comments and suggestions. And the investigator provides a relevant interpretation if the interviewee has questions. With valuable suggestions contributed by the practitioners interviewed, the questionnaire was improved by making the question more appropriate and clearer.

3. RESULTS AND ANALYSIS

3.1. Respondents' Background

From the analysis, the job designations of respondents are mainly managers (70%) and director (30%). In term of status of companies, 82% were from private companies and only 18% come from national government link companies.

3.2. Strategic Management Practices

Vision and Mission

From Table 1, it can be seen that most companies surveyed already have vision and mission, although there are still some that do not have vision and mission. The number of companies that have the same vision with the number of companies that have a mission.



Table 1. Company Vision and Mission

		Frequency	Percent	Valid Percent	Cumulative Percent
Vision	Available	25	83.3	83.3	83.3
	Not Available	5	16.7	16.7	100
	Total	30	100	100	
Mission	Available	25	83.3	83.3	83.3
	Not Available	5	16.7	16.7	100
	Total	30	100	100	

Company Objectives

Table 2 shows that 73.3% of respondents have long-term objectives, 80% of respondents have medium-term objectives and 46.7% of respondents have short-term objectives. This means that almost all respondents have realized the importance of having goals.

Table 2. Goal Statement

		Frequency	Percent	Valid Percent	Cumulative Percent
Long Term Objective	Yes	22	73.3	73.3	73.3
	Unsure	8	26.7	26.7	100
	Total	30	100	100	
Middle Term Objective	Yes	24	80	80	80
	No	5	16.7	16.7	96.7
	Unsure	1	3.3	3.3	100
	Total	30	100	100	
Short Term Objective	Yes	14	46.7	46.7	46.7
	Unsure	16	53.3	53.3	100
	Total	30	100	100	

Formal Written of Objectives

Table 3 shows that the majority of respondents (83.3%) have "recording" the company's objectives meaning that most of these respondents have already made formal strategic management, while the rest (16.7%) do so informally.

Table 3. Formal Written of Objectives

		Frequency	Percent	Valid Percent	Cumulative Percent
Written Objectives	Yes	25	83.3	83.3	83.3
	No	5	16.7	16.7	100
	Total	30	100	100	

General Performance of Company

Table 4 shows the size of respondents for company sales per year (IDR) values regarding to written long-term objective together with company sales, company profit per year, and number of projects. According to table 4, the company which had long-term objective and written objective obtained very high level of performance 14 out of 15 respondent (93%) had gained more than 5 trillion rupiah in the last years. The company which had long term objective with unwritten objective had poorer performance when compared to companies with written performance. All companies (100%) reached the sales achievement in ranging 500 billion – 1 trillion.



Table 5 shows that companies with long term objectives will have more projects than companies that do not have long term objectives (22 companies versus 8 companies or 73%). Companies that have written objectives have more projects as well.

Table 4. General Performance of Company

Long Term Objective	Written Objective	Company Sales per Year (IDR)			Total	Company Profit		Total
		500 billion - 1 trillion	1 - 5 trillion	> 5 trillion		< 5%	5 - 10%	
Yes	Yes	5		14	19	3	16	19
		26.30%		73.70%	100.00%	15.80%	84.20%	100.00%
	No	3		0	3	0	3	3
		100.00%		0.00%	100.00%	0.00%	100.00%	100.00%
Unsure	Total	8		14	22	3	19	22
		36.40%		63.60%	100.00%	13.60%	86.40%	100.00%
	Yes		5	1	6		6	6
			83.30%	16.70%	100.00%		100.00%	100.00%
Total	No		2	0	2		2	2
			100.00%	0.00%	100.00%		100.00%	100.00%
	Total		7	1	8		8	8
			87.50%	12.50%	100.00%		100.00%	100.00%
Total	Yes	5	5	15	25	3	22	25
		20.00%	20.00%	60.00%	100.00%	12.00%	88.00%	100.00%
	No	3	2	0	5	0	5	5
		60.00%	40.00%	0.00%	100.00%	0.00%	100.00%	100.00%
Total	Total	8	7	15	30	3	27	30
		26.70%	23.30%	50.00%	100.00%	10.00%	90.00%	100.00%

Table 5. Number of Company Project

Long Term Objective	Written Objective	Number of Project			Total
		< 5 projects	5 - 10 projects	10 - 15 projects	
Yes	Yes	5	8	6	19
		26.30%	42.10%	31.60%	100.00%
	No	3	0	0	3
		100.00%	0.00%	0.00%	100.00%
Unsure	Total	8	8	6	22
		36.40%	36.40%	27.30%	100.00%
	Yes		5	1	6
			83.30%	16.70%	100.00%
Total	No		2	0	2
			100.00%	0.00%	100.00%
	Total		7	1	8
			87.50%	12.50%	100.00%
Total	Yes	5	13	7	25
		20.00%	52.00%	28.00%	100.00%
	No	3	2	0	5
		60.00%	40.00%	0.00%	100.00%
Total	Total	8	15	7	30
		26.70%	50.00%	23.30%	100.00%

Key Success Factor in Industry

Table 6 shows respondents' perceptions of the factors that are key to success (KSF) in being able to compete in the industry. From the table it can be seen that 100% of respondents agree that excellence in promise and quality service are the most important and very important factors to be able to compete in this industry.



Table 6. Importance of Key Success Factor

	Not Necessary	Not Important	Important	Very Important	No Comments	Total
KSF Marketing		6 20%	16 53%	8 27%		30 100%
KSF Excellence in Promise			15 50%	15 50%		30 100%
KSF Value Creation		6 20%	9 30%	15 50%		30 100%
KSF Quality Service			15 50%	15 50%		30 100%
KSF Customer Satisfaction			30 100%			30 100%
KSF Management Team			16 53%	14 47%		30 100%

External Environment Assessment

Table 7 shows that market segmentation is a major factor and very important in the work plan. It can be seen as 22 respondents (73%) stated that it is an important factor and 8 respondents (27%) consider this a very important factor. The large companies we surveyed were also considered weather as important (50%) and very important (50%).

Table 7. Importance of External Factors

External Factor Assessment	Not Necessary	Not Important	Important	Very Important	No Comments	Total
Capital Adequacy		7 23%	16 53%	7 23%		30 100%
Cost Increase		23 77%	7 23%			30 100%
Government Policy			30 100%			30 100%
Market Segmentation			22 73%	8 27%		30 100%
Work Ethic		8 27%	22 73%			30 100%
Innovation			30 100%			30 100%
Weather			15 50%	15 50%		30 100%
Same Supplier			30 100%			30 100%
Buyer			30 100%			30 100%

Strength and Threat Assessment

Table 8 shows the number of respondents who stated that the company has strong customer relationships (23%). It can be seen as many as 22 respondents have a strong customer relationship. And only 23% say they have a strong organizational structure.



Table 8. Strength and weakness of companies

Strength & Weakness	Very Strong	Strong	Average	Weak	Very Weak	Total
Organization Structure		7 23%	23 77%			30 100%
Customer Relation		22 73%	8 27%			30 100%
Financial & Profitability		15 50%	11 37%	4 13%		30 100%

Table 9 shows the ability of resource in technology not to be a major threat to the company, they consider the increasing competition and price of materials to be a big threat. Government intervention is still not a major threat since most respondents come from the private sector.

Table 9. Threats Assessment

Threats Assessment	Very Strong	Strong	Average	Weak	Very Weak	Total
Resource Capability		8 27%	22 73%			30 100%
Government Intervension		14 47%	16 53%			30 100%
Material Price		30 100%				30 100%
Competitors	7 23%	15 50%	8 27%			30 100%
Material Availability		22 73%	8 27%			30 100%

4. CONCLUSION

The construction industry is closely related to the uncertainty in the environment that may affect the performance of a company. High competition and many other negative aspects in the external environment, which become threats to companies to develop their business that need to be handled carefully through strategic management approach. The implementation of strategic management practices in organizations can help them to enhance their performance through improved effectiveness, efficiency and flexibility. In order to improve the performance, the implementation of strategic management shall be conducted properly. It shall analyze the external environment to obtain information in term of threats and opportunities, and carry out the internal environment assessment to evaluate the company's strengths and weaknesses in order to cope with the threats and opportunities.



REFERENCES

- [1] Arain, Faizal Manzoor and Low Sui Peng (2005), “A Knowledge-Based System as a Decision-Making Tool for Effective Management of Variations and Design Improvement: Leveraging on Information Technology Applications”, Published at <http://itcon.org/2006/27/>.
- [2] Betts, M., & Ofori, G. (1999). Strategic management in construction. Oxford: Blackwell Science.
- [3] Blair, B. (2009). Strategy in the eye of the storm. Raleigh, North Carolina: FMI Corporation.
- [4] Bryson, J. (2010), “The future of public and nonprofit planning in the United States Public Administration Review: Special Issue on the Future of Public Administration in 2020”.
- [5] Carpenter, M. A., and Sanders, W. G. (2009). Strategic Management A Dynamic Perspective Concepts, 2nd edition. London: Pearson Education Edition.
- [6] Certo and Peter (1991). Strategic Management: Concepts and Application. New York: McGraw-Hill.
- [7] Chandler, A. (1962). Strategy and structure: Chapters on the history of the American industrial enterprise. Cambridge: MIT Press.
- [8] Chinowsky, P., & Meredith, J. (2000), “Strategic management in construction”, Journal of Construction Engineering and Management.
- [9] Chiragi, F. (2000), “Building Construction Industry in Tanzania Case Study: Youth Sports Centres Complex at Mwananyamala, Dar-es-salaam”, Journal of Building Construction Industry in Tanzania.
- [10] David, Fred R. (2003). Strategic Management: Concepts and Cases, 9th ed. Upper Saddle River, N.J: Prentice Hall.
- [11] Dye, R. and Sibony, O. (2007), “How to improve strategic planning”, McKinsey Quarterly.
- [12] FMI’s Construction Outlook (2017), “First Quarter Report with Second Quarter Nonresidential Construction Index”.
- [13] Ibbs, C. W., Wong, C.K. and Kwak, Y.H. (2001), “Project change management system”, Journal of Management in Engineering.
- [14] Johnson, G., Scholes, K., and Whittington, R. (2007). Exploring Corporate Strategy (8th ed.). England: Pearson Education Limited.
- [15] Kerzner Harold (2001). Project Management: A System to Planning, Scheduling and Controlling, 7th Edition. USA: John Wiley & Sons.
- [16] Nag, R., Hambrick, D., and Chen, M. (2007), “What is strategic management really?”, Inductive derivation of a consensus definition of the field, Strategic Management Journal.
- [17] Pamulu, Muhammad Sapri (2010), “Strategic Management Practices in The Construction Industry: A Study of Indonesian Enterprises”, PhD Dissertation. QUT.
- [18] Porter, M.E. (1980). Competitive Strategy: Techniques for Analyzing Industries and Competitors. New York: Free Press.
- [19] Pranoto (2005), “Menyiasati KKN Sektor Konstruksi”. Indonesia: LPJK.
- [20] Price, A. D. F., Ganiev, B. V. and Newson, E. (2003), “Changing strategic management practice within the UK construction industry”, Strategic Change.
- [21] PricewaterhouseCoopers (2013), “Reconstructing productivity: Productivity in the Construction Industry”, Australia.
- [22] Stahl, Michael J. and David W. Grigsby (1992). Strategic Management: Formulation and Implementation. PWS-Kent Pub. Co.
- [23] Sudarto (2007), “Penggunaan Knowledge Based Management System untuk Meningkatkan Kinerja Perusahaan Jasa Konstruksi di Indonesia”, Unpublished PhD Dissertation. Jakarta: University of Indonesia.
- [24] Sutjipto (1991), “Strategi Industri Jasa Konstruksi Nasional Dalam Era Globalisasi”. Jakarta.
- [25] Todaro, M. (2011). Economic Development, 11th. New York: Pearson Education.



INTERNATIONAL ASIAN CONGRESS ON CONTEMPORARY SCIENCES – VII

- [26] Trigunarsyah, B. (2006). Industri Konstruksi. In P. D. Umum, Konstruksi Indonesia; Membangun Daya Saing Bangsa. Jakarta: Badan Pembinaan Konstruksi & Sumber Daya Manusia.
- [27] Undang-Undang Republik Indonesia Nomor 2 Tahun 2017 tentang Jasa Konstruksi.
- [28] Viljoen, John and Susan Dann (2000). Strategic Management. Frenchs Forest, N.S.W.: Prentice Hall.
- [29] Wheelen, Thomas L. and J. David Hunger (1984). Strategic Management. USA: Addison-Wesley.
- [30] Yates, J. K. (2007). Global Engineering and Construction. USA: John Wiley and Sons.



THE EFFECTIVENESS OF WOMEN FARMERS' GROUP PROGRAMS AGAINST FOOD INSECURITY DURING THE COVID-19 PANDEMIC (STUDY CASE IN BUARAN, TANGSEL, INDONESIA)

Fisy Amalia

Eko Cahyo Mayndarto

STIE Ganesha, Economy, Jakarta, Indonesia

Tama Jagakarsa University, Economy, Jakarta, Indonesia

Abstract

This Research aims to get The Effectiveness of the Women's Farmer Group Program on Food Insecurity during the Covid 19 Pandemic. The study was conducted from March 2021 to August 2021. The subject of the study was the Azzahra Women's Farmer Group in Buaran, South Tangerang. The research methods is qualitative method. The data taken are primary and secondary data, primary data is taken from observations and interviews with the Chairperson, coaches and group members. Secondary data is the result of literature review. The results of observations and interviews conducted showed that women's farmer groups have carried out effective activities in order to prevent food insecurity during the Covid-19 pandemic because they can help provide cheap food sources for their surroundings (Rukun Warga 05 Buaran environment), are able to increase the income sources of their members., able to donate to orphans and able to pay operational loans within two years. Beginning with the processing of unused land covering an area of three hundred meters to ten thousand meters in three years. At the beginning of processing, the selected plants are vegetables as food items that are sold to members and the surrounding environment which are purchased at low prices, thereby effectively reducing the household expenses of the members. The results of this study prove that group farming by cultivating unused land can be an effective solution to prevent food insecurity.

Keywords: Effectiveness, Covid -19 Pandemic, Women Farmers Group, Solutions, idle land



ANALYSIS THE EFFECT OF AGE, EDUCATION AND JOB ON COMMUNITY PERCEPTIONS OF NON-BANK SHARIA HOUSING (STUDY CASE: SOUTH TANGERANG COMMUNITY, BANTEN PROVINCE OF INDONESIA)

Hendra Candra

STIE Ganesha, Economy, Jakarta, Indonesia

Abstract

In Indonesia right now has two Economic System namely Conventional Economy and Sharia Economy, based on those two systems, many businesses using Sharia name such as sharia bank, sharia insurance and sharia housing. In Sharia housing has two different types, which is Sharia housing under sharia bank and Sharia housing non-bank. In this research, only focus to Sharia housing non-bank because they are slogans so interesting like no usury, no down payment and no confiscation. This research purpose is to analyze the effect of Age, Education and Job on community perceptions of non-bank sharia housing. This research method is quantitative descriptive where the population is at South Tangerang and the sampling technique using *Cluster Random Sampling* (CRS) with two steps, the first step using *Cluster Sampling* and the second step using *Stratified Random Sampling*. The data collecting using hardcopy questionnaires were arranged by *likert scale* and the technique analyze using *Structure Equation Modeling* (SEM) with AMOS tool. The questionnaire tested with reliability and validity test and the result is valid and reliable and the simultaneous regression test shown if the Age and Job is not affected to the community perceptions but for the Education is affected to the community perceptions, these mean if the South Tangerang community is not or not yet having a trust to non-bank Sharia housing.

Keywords: Sharia Housing, Community Perceptions, Non-Bank

INTRODUCTION

The Presence of sharia housing can be an alternative in having a residence with a sharia scheme that is safe, healthy and in accordance with Islamic law. According to (beritasatu.com, 2016) usually the scheme offered by sharia developers as sharia housing developers is that consumers can buy houses to sharia developers directly without the presence of banks or third parties involved in the process. As for the transaction, the amount of Down Payment (DP) percentage given to potential consumers varies according to the policy of the sharia developer itself, but usually the DP requested is quite high, then the rest will be paid directly to the sharia developer. Meanwhile, the installment period offered also varies according to the agreement which is not more than 10 years.

This sharia housing offers the concept of Islamic housing or known as Sharia Property which is certainly developed by a development company on behalf of itself as a Sharia Developer. Sharia developers not only develop sharia housing products but also in the form of productive land, sharia plots, sharia apartments, halal houses and so on.

Because more and more sharia housing has begun to be developed, it does not mean that sharia developers or developers do not get challenges in the process of establishing their business



foundation, because sharia developers themselves are new players in the property sector who in fact still lack experience and do not understand the flow of the twists and turns of the property business in Indonesia.

According to (Firmansyah, 2017) in his journal entitled *The Non-Bank Islamic Mortgage: Prospect and Challenges* that the practice of non-bank Sharia mortgages has the opportunity to develop in the coming years as explained by several previous facts. Nonetheless, this trend also has some challenges that makes growth go slow. This non-bank proximity also presents a challenge for sharia bank who are also developers so that they have competitors in terms of providing housing products. Thus, Islamic banks need to redefine their mortgage products in the face of competition with non-bank Sharia mortgage developers. The government also needs to make some regulations to protect developers and customers of non-bank Islamic mortgages. So, both parties can later make safer transactions.

This research will be concentrated only on the city of South Tangerang because South Tangerang is a very strategic city where the area is adjacent to DKI Jakarta which in fact is the capital of the Republic of Indonesia. The regional boundary of South Tangerang City is the northern region bordering Tangerang City, the eastern region bordering DKI Jakarta, the Southern region bordering Bogor Regency and Depok City and the western region bordering Tangerang Regency.

Research Hypothesis

The purpose of this study is to analyze the effect of age, education and job on community perceptions in South Tangerang regarding non-bank Sharia housing with the following hypothesis:

H1: Age effects on community perception of non-bank *Sharia* Housing.

H2: Education effects on community perception of non-bank *Sharia* Housing.

H3: Work effects on community perception of non-bank *Sharia* Housing.

LITERATURE REVIEW

Definition of Perception

According to Sugihartono in (Nursalam & Syarifuddin, 2017) suggests that perception is the brain's ability to translate stimuli or processes to translate stimuli that enter the human sense apparatus. Human perception there are different points of view in sensing, there are those who perceive something as good or a positive perception or a negative perception that will affect human actions that are visible or real.

Perception according to (Nursalam & Syarifuddin, 2017) in his journal that perception can be interpreted as a process of observing a person's environment by using his senses so that he becomes aware of everything in his environment.

Based on the understandings of perception above, it can be interpreted that perception is a process of translating a stimulus that enters through the five senses to interpret information when observing the environment to create a meaningful picture of the world.

Definition of Community

The definition of community in (Tejokusumo, 2014) according to Selo Soemardjan community is people who live together and produce culture. Meanwhile, according to Weber, society as a structure or action is basically determined by the expectations and values that are dominant in its citizens. And according to Durkheim society as an objective reality the individual's yang are its members.



Based on the above understanding that the understanding of society is a group of people who form a system and live together and form a culture where the structure is determined by the dominant values or objective reality of the individual citizens.

Definition of Education

According to (KBBI, 2020) the definition of education is the process of changing the attitudes and practices of a person or group of people in an effort to mature humans through teaching and training efforts, processes, ways and actions of educating.

The education according to Law No. 20 concerning (National Education System, 2003) is a conscious and planned effort to create a learning atmosphere and learning process so that students actively develop their potential to have religious spiritual strength, self-control, personality, intelligence, noble character, as well as the skills needed for themselves, society, nation and state.

Based on the above understanding that the notion of education is a lifelong learning process that leads to changes in the attitudes and practices of a person or group to gain valuable understanding and experiences in his life to develop his potential.

Definition of Age

The definition of age according to (KBBI, 2020) is the length of time lived or existed (since birth or held).

As for according to (dictionary.com, 2020) age or age is a period of human life measured from the year from birth, usually characterized by a certain stage or level of mental or physical development and involves responsibility and legal capacity.

Based on the information above, it can be interpreted that the definition of age is the length of lifetime calculated from birth to advanced adulthood, which is > 60 years.

The age or age classification according to the Ministry of Health of the Republic of Indonesia in (Amin & Juniati, 2017) is as follows:

- Toddler Period = 0 – 5 years.
- Childhood = 6 – 11 years.
- Early Adolescence = 12 – 16 years.
- Late Adolescence = 17 – 25 years.
- Early Adulthood = 26 – 35 years.
- Late Adulthood = 36 – 45 years.
- Early Seniors = 46 – 55 years.
- Late Seniors = 56 – 65 years.
- Senior Period = 65 years - top

Meanwhile, in this study, the age or age indicators that will be the material for the study are during the age or productive age of work, namely as follows:

- Late Adolescence = 17 – 25 years.
- Early Adulthood = 26 – 35 years.
- Late Adulthood = 36 – 45 years.
- Early Seniors = 46 – 55 years.

Definition of Work

As for Work according to (KBBI, 2020) etymologically derived from the basic word work which is a noun which means activity to do something for a living or livelihood. Whereas the work itself means



something that is done, done, done, a livelihood that is used as a staple of livelihood, something that is done to earn a living.

Meanwhile, according to (Setiawan, 2020) work is an activity that must be carried out by everyone for their survival or to meet various kinds of needs in life. Everyone does work, one of which is to meet their basic needs, because basic needs are needs that must be met and cannot be delayed.

The previous study conducted by Egi Arvian Firmansyah (2016) was entitled: “Non-Bank Approach in Islamic Mortgage: The Evidence from Indonesia” concludes that This phenomenon is prevalent in Indonesia along with the surging websites facilitating selling and buying of the housing. On the other hand, this also creates competition for the Islamic banks. Thus, the Islamic banks and Islamic scholars need to work harder to provide a more Islamic mode of financing. To secure the supply and make sure house availability, the government needs to make regulation in housing ownership. For example, setting the higher tax for the second, third and subsequent house to give a chance to the people who really need a house for them to stay, not for the investment purpose.

RESEARCH METHODOLOGY

This research uses a quantitative descriptive method which according to (Sugiyono, 2016) descriptive statistics is a way of analyzing statistical data by describing or describing statistical data which aims to make a conclusion without general intention. While quantitative research is research that uses positive thinking that is carried out randomly to examine a sample and collect data using research instruments while data analysis is carried out statistically whose purpose is to test previously set hypotheses.

The data collection is by distributing hardcopy manual questionnaires made using the *Likert Scale* as well as documentation of literature studies from scientific journals, theses, books, and trusted websites.

The data source uses Primary Data, namely data collection with the technique of distributing questionnaires to respondents who are encountered randomly, both from Islamic boarding schools, academics, and the general public as well as Secondary Data which is carried out with documentation collection techniques from various sources such as theses and journals that discuss non-bank Sharia mortgages and literature related to non-bank Sharia housing.

The planned population is the people of south Tangerang city which according to bps (Central Statistics Agency) data from South Tangerang is estimated in 2019 to be 1,747,906 people consisting of the total population of Setu district 92,890 people, Serpong 199,283 people, Pamulang 368,603 people, Ciputat 252,262, Ciputat timur 219,261 people, Pondok Aren 418,420 people and North Serpong as many as 197,187 people.

While the sampling uses the *Cluster Random Sampling* (CRS) technique because the data source is very wide, the sample is only in the predetermined population area and two stages of sampling techniques are carried out, namely the first stage of determining in advance the sample area (*Cluster Sampling*) and the second stage by determining who are the respondents who will be submitted a questionnaire to that area randomly (*stratified random sampling*).

The analysis technique uses the AMOS (*Analysis of Moment Structural*) program with the *Structural Equation Modeling* (SEM) method.



DISCUSSION

Characteristics of Respondents

The target number of samples to be collected is as many as 200 respondents. 250 questionnaires that have been distributed, only 227 questionnaires can be collected while 23 questionnaires have not returned. The characteristics of the respondents are as follows: -

Gender

In this study, respondents who were recorded based on gender were men as many as 143 people (68.63%) and women as many as 84 people (31.37%). Here's a table of respondents by gender:

Table 4.1 Characteristics of Respondents by Gender

No	Gender	Total	Percentage (%)
1	Men	143	62,99
2	Women	84	37,01
	TOTAL	227	100 %

Source: Questionnaire Data Processing

Based on the table above, respondents in this study were dominated by men as much as 62.99% while for women only 37.01%.

Age Group

The characteristics of respondents based on age group or age are as follows:

Table 4.2 Characteristics of Respondents by Age

No	Age	Total	Percentage (%)
1	20yo ~ 29yo	107	47,14
2	30yo ~ 39yo	38	16,74
3	40yo ~ 49yo	44	19,38
4	50yo ~ 59yo	23	10,13
5	> 60yo	15	6,61
	TOTAL	227	100 %

Source: Questionnaire Data Processing

Based on the table above, respondents were dominated by the ages of late adolescence to late adulthood close to the early elderly, namely the age range of 20yo – 29yo (47.14%) and 40yo – 49yo (19.38%).

Education Group

The level of education of the respondents is presented in the following table:-

Table 4.3 Characteristics of Respondents by Education

No	Education Level	Total	Percentage (%)
1	Elementary	12	5,29
2	Junior High School	25	11,01
3	High School	63	27,75
4	Diploma	9	3,96
5	Bachelor	101	44,50
6	> Bachelor	17	7,49
	TOTAL	227	100 %

Source: Questionnaire Data Processing

Based on the table above, it shows that based on the level of education, there are 63 people (27.75%) respondents who have a high school education and 101 people (44.50%) respondents have a bachelor's education, while others have no more than 12%.



Job Group

Here's a presentation table for the job group.

Table 4.4 Characteristics of Respondents by Job

No	Job	Total	Percentage (%)
1	Univ. Student	93	40,97
2	Self employed	68	29,96
3	Gov. Employee	17	7,49
4	Housewife	9	3,96
5	Employee	27	11,89
6	Others	13	5,73
	TOTAL	227	100%

Source: Questionnaire Data Processing

Based on the table above, based on the job group, most of the respondents in this research is university students 93 peoples (40.97%), self-employed as many as 68 peoples (29.96%), private employees as many as 27 peoples (11.89%), while housewife only 9 peoples (3.96%) and government employee only 17 peoples (7.49%).

Validity and Reliability Test

The correlation value between the total score of an indicator and the score of an indicator is positive and greater than that of *cronbach alpha* which is 0.30 ($r \geq 0.30$) then the instrument is considered valid and if the correlation < 0.30 then the instrument is considered invalid, so it is required to be revised or discarded.

For the reliability coefficient calculation method used is *Spearman Brown (Split Half)* where the correlation between the total score and the grain is greater than *cronbach alpha*, which is 0.30 ($r \geq 0.30$) then the instrument is considered reliable and if the correlation value is below 0.30 then the instrument is not reliable.

The results of the validity and reliability testing we can see in the table below:

Table 4.5 Result of Validity and Reliability Test

Variables	Question	r-count	result	r-count	result
Age	U.1	0,587	Valid	0,317	Reliable
	U.2	0,537	Valid		
	U.3	0,483	Valid		
	U.4	0,402	Valid		
	U.5	0,379	Valid		
Education	PD.1	0,441	Valid	0,524	Reliable
	PD.2	0,682	Valid		
	PD.3	0,574	Valid		
	PD.4	0,700	Valid		
	PD.5	0,753	Valid		
Job	PK.1	0,541	Valid	0,462	Reliable
	PK.2	0,599	Valid		
	PK.3	0,511	Valid		
	PK.4	0,516	Valid		
	PK.5	0,615	Valid		

Source: Data Processing by Own

Based on the table above, the correlation of the three variables consisting of five questions each, the lowest r-count correlation value is 0.379 and the highest is 0.753. This shows that the results of the validity test are all greater than *the cronbach alpha* 0.30 so that all question items are declared Valid.



Meanwhile, the results for the reliability test can be seen from the total score of each variable where the lowest r-count correlation value is 0.317 and the highest is 0.524 and all of them are higher than the *cronbach alpha* value of 0.30 where this shows that all question items are declared Reliable.

Evaluate Models with *Criteria Goodness of Fit*

After the researcher has taken steps to modify the model, the indicators that have met the *Goodness of Fit* method and indicators that do not meet the conformity test method and statistical tests, for details can be observed in the table below:

Table 4.7 Model 2 *Goodness of Fit Index AMOS*

Goodness of fit index	Cut of value	Result	Criteria
X² - Chi-square	$\leq \alpha \cdot df < X^2$	51,33 < 149.72	Fit
Sig. Probability	$\geq 0,05$	0.139	Fit
DF	> 0	132	Fit
RMSEA	$\leq 0,08$	0.036	Fit
GFI	$\geq 0,90$	0.877	Not Fit
AGFI	$\geq 0,90$	0.823	Not Fit
CMIN/DF	$< 2,0$	1.134	Fit
TLI	$\geq 0,95$	0.95	Fit
CFI	$\geq 0,95$	0.960	Fit

Source: Data Processing by Own

a. *Chi-square statistic* (χ^2).

The command to bring up the *Chi-Square* value in the AMOS program is to type `\cmin`. It is expected that the value that appears is smaller than the value of *Chi-Square* in the table so that a *Chi-Square* value of 149,720 is obtained, which means that it has met the *Goodness of Fit method*.

b. *Probability*.

Bring it up by typing `\p`. Where the expected value is more than 0.05 (5%) and the value obtained is 0.139, so that it has met the *Goodness of Fit method*. Probability is a value that must be met.

c. *Differential Frequency*.

Raised with DF/ expected value greater than 0. The results of this study prove, the value of DF is $132 > 0$, which means that DF has met the *Goodness of Fit method*.

d. *Root Mean Square Error Approximation* (RMSEA).

Bringing it up via the `rmsea` command. It is expected that the value that appears is less than < 0.08 . The results of this study prove that the RMSEA value of 0.036 means that it has met the *Goodness of Fit method*.

e. *Goodness of Fit Index* (GFI).

It raises it via the `\gfi` command, and it is expected that the value that appears is greater than 0.9. The results of this study prove that the GFI value is 0.877, which means that the GFI does not meet the requirements of the *Goodness of Fit* rules.

f. *Adjusted Goodness of Fit Index* (AGFI).

It raises it via the `\agfi` command, and it is expected that the value that appears is greater than 0.9. The results of this study prove that the AGFI value is 0.823, which means that AGFI does not meet the rules of *Goodness of Fit*.

g. *The Minimum Sample Discrepancy Function or Degree of Freedom* (CMIN/DF).



It brings it up via the \cmin/df command and it is expected that the value that appears is smaller than 2. The results of this study prove that the CMIN / DF value is 1,134, meaning that CMIN / DF has met the rules of Goodness of Fit.

h. *Tucker Lewis Index (TLI)*.

Bring it up via the \tli command and it is expected that the value that comes out is greater than 0.95. The results of this study prove that the TLI value is 0.95 which means that the value is equal to 0.95, meaning that the TLI value has met the *Goodness of Fit method*.

i. *Comparative Fit Index (CFI)*.

It raises it via the \cfi command, and it is expected that the value that comes out is greater than 0.95. The results of this study prove that the CFI value is 0.960, which means that the *Comparative Fit Index (CFI)* value has met the Goodness of Fit method.

Interpreting The Test Results

A way of modifying a model that has been assembled is by inputting or adding arrows between constructs (it can also be by adding hypotheses) or another way is that between the model indicators two arrows are added which a strong theory must support.

In the assessment of the feasibility of the model later by comparing the model before modification with the model after modification. After the Model is declared feasible or meets the *Goodness of Fit* method, it needs to be interpreted to make it easier to understand, in the following description will be interpreted from the output of AMOS Version 23 as follows:

Table 4.8 *Regression Weights (Group No. 1 – Default Model)*

	Variable		Estimate	S.E.	C.R.	P	Result
PS	<---	AGE	-5.457	17.521	-.311	.755	Rejected
PS	<---	EDU	-.034	.114	-.298	.039	Accepted
PS	<---	JOB	.611	.622	.983	.326	Rejected

Source: *Data Processing by Own*

The results of statistical tests using *Regression Weights* from the results of the AMOS Version 23 test based on probability results with a *significant Probability* limit value of 0.05 or 5%, can be explained in the table below: -

Table 4.9 *The Hypothesis Conclusion*

No	Hypothesis	Prob.	Limit	Result
1	The Effect of Age on Perception	0,755	0,05	No Effect
2	The Effect of Education on Perception	0,039	0,05	Effected
3	The Effect of Job on Perception	0,326	0,05	No Effect

Source: *Data Processing by Own*

based on table 4.9 above, the Hypothesis can be translated as follows:

H1: Age has no effect on community perception of non-bank Sharia Housing.

H2: Education has effect on community perception of non-bank Sharia Housing.

H3: Job has no effect on community perception of non-bank Sharia Housing.



RESULT

1. The Effect of Age on Perception

The results of the analysis show that the probability value for age is 0.755 which means that the value is greater than the predetermined limit of 0.05 or 5%, which means that age does not affect the perception of people in south Tangerang on non-bank Islamic housing.

2. The Effect of Education on Perception

The results of the analysis show that education affects the perception of people in south Tangerang on non-bank Islamic housing. This can be seen from the probability value of 0.039 which is smaller than the predetermined limit of 0.05 or 5%.

3. The Effect of Work on Perception

The results of the analysis show that the probability value for employment is 0.326 which means that the value is more than the specified limit of 0.05 or 5%, which means that the work has no effect on the perception of people in south Tangerang on non-bank Islamic housing.

CONCLUSION

Based on the results of the research and discussion that has been described above, the two indicators used, namely age and occupation, do not affect people's perceptions while education indicators affect people's perceptions in south Tangerang towards non-bank Sharia housing applied by *developers*. housing sharia although more than 75% of respondents answered strongly agreed and agreed that age, education and employment can affect mindset and perception.

The advice that can be given is that if for researchers who are interested in discussing the same topic, they can add several other additional indicators or gather respondents above 227 respondents in order to get the expected results and for Sharia Developers if they can really carry out the sharia concept well and design sharia-compliant financing schemes based on the slogans carried out, because in fact even though it carries the slogans "without a bank" but there are certain records that suggest using a Sharia Bank if the financing is above 2 years.

BIBLIOGRAPHY

- Amin, M. Al, & Juniati, D. (2017). *Klasifikasi Kelompok Umur Manusia Berdasarkan Analisis Dimensi Fraktal Box Counting Dari Citra Wajah Dengan Deteksi Tepi Canny*. Jurnal Ilmiah Matematika
- Beritasatu.com. (2016). *Developer Syariah: Solusi Lain Kepemilikan Rumah Bagi Masyarakat*. <https://www.beritasatu.com>
- Dwitama, F. (2019). *Merasa Ditipu, Warga "Geruduk" Kantor Pengembang Syariah di Bintaro*. <https://www.medcom.id/nasional/daerah>
- Elsye, M. A. W. (2017). *Pengaruh Persepsi, Kepribadian dan Sikap Terhadap Keputusan Pengembang Perumahan Menjadi Mitra Bank Syariah Pekanbaru*. Wira Ekonomi Mikroskil
- Firmansyah, E. A. (2017). *The Non-Bank Islamic Mortgage: Prospect and Challenges*.
- Firmansyah, E. A., & Indika, D. R. (2017). *Kredit Pemilikan Rumah Syariah Tanpa Bank: Studi di Jawa Barat*. Jurnal Manajemen Teori Dan Terapan | Journal of Theory and Applied
Olongapo City, Philippines <https://www.asyakongresi.org/> **December 09-11,2022**



Management

- Firmansyah, Egi Arvian dan Indika, Deru R. 2017. *Kredit Pemilikan Rumah Syariah Tanpa Bank*. Bandung : Jurnal Manajemen Teori dan Terapan Vol 10 No. 3
- Hidayatullah, A., & Thantawi, T. R. (2017). *Persepsi Masyarakat Kota Bogor terhadap Skim Pembiayaan KPR Syariah*. Nisbah: Jurnal Perbankan Syariah
- Hendra, C., Amrizal. (2020). *Persepsi Masyarakat Tangerang Selatan terhadap Pembiayaan Non-Bank pada Perumahan Syariah*. Tesis ITB Ahmad Dahlan Jakarta.
- I Gusti Putu Ngurah Adi Santika, S.Pd., M. F. (2015). *Hubungan Indeks Massa Tubuh (IMT) dan Umur terhadap Daya Tahan Umum (Kardiovaskuler) Mahasiswa Putra Semester II Kelas A Fakultas Pendidikan Olahragadan Kesehatan IKIP PGRI Bali Tahun 2014*. Biomass Chem Eng.
- Idris, M. (2014). *Implementasi Pembiayaan Pemilikan Rumah (PPR) Syariah studi kasus pada Griya Ar-roya di kota Makasar* [UIN Alaudin Makasar]
- KBB I. (2020). *Kamus Besar Bahasa Indonesia*. <https://kbbi.kemdikbud.go.id/>
- Nidia Sari, I. A. (2016). *Persepsi Masyarakat Banjar Kedaton Kelod Mengenai Kinerja Jumantik Tahun 2016*
- OJK Indonesia. (2020). *Statistik Perbankan Syariah*. Otoritas Jasa Keuangan. <https://www.ojk.go.id>
- Sania Purnama Sabara, N. (2014). *Pengaruh Motivasi Kerja dan Gaya Kepemimpinan terhadap Kepuasan Kerja dan Kinerja Karyawan pada Bank Sinarmas dan Bank Mega Cabang Kendari*. Universitas Muhamadiyah Jakarta
- Setiawan, S. (2020). *Pekerjaan*. <https://www.gurupendidikan.co.id>
- Sholihin, A. I. (2018). *Hati-hati dengan KPR Tanpa Bank*. <https://sharianews.com>
- Sugiyono, P. D. (2016). *metode penelitian kuantitatif, kualitatif, dan R&D*. cv. Alfabeta
- Sumarsih. (2014). *Pengaruh Pendidikan dan Pelatihan terhadap Kinerja Pegawai pada Badan Kepegawaian Daerah Kabupaten Kuantan Singingi*. [UIN SUSKA RIAU]. <http://repository.uin-suska.ac.id>
- Tan, A. (2014). *The Real Secret of Successful Investor and Developer*. PT. Elex Media Komputindo.
- Tejokusumo, B. (2014). *Dinamika Masyarakat Sebagai Sumber Belajar Ilmu Pengetahuan Sosial*. Geoedukasi
- Triyanto, T. (2014). *Pengantar Pendidikan* (Y. Sri Hayati (ed.)). PT. Bumi Aksara. Sistem Pendidikan Nasional, Pub. L. No. Bab 1, Pasal 1 (2003). <https://www.unpad.ac.id>
- Wijaya, A. dan W. P. A. (2017). *Hukum Bisnis Properti di Indonesia* (Tim Grasindo (ed.)).



**EFFORTS TO IMPROVE THE QUALITY OF HUMAN RESOURCES IN FACING
GLOBAL COMPETITION AFTER COVID 19**

Elli Sulistyaningsih

Borobudur University, Management, East Jakarta, Indonesia

Abstract

The role of human resources is affirmed in the outline of state policy that the essence of Indonesia's national development is to build a complete Indonesian nation and all Indonesian people. In addition, in the general pattern of long-term development II, it is also emphasized that the main goal of national development is to improve the quality of Indonesian society and society. Human resources are the driving force of the activities of a country, in which citizens are concerned that carrying out all state activities, such as political, economic and others. In addition to running the wheels of government, the population also manages all natural resources that are wealth for the country concerned. The population of a country of good quality will strive to cultivate and utilize existing natural resources, to meet the needs of life and improve their welfare and be able to manage their country's wealth properly and efficiently. Competency and professional-based human resource development is carried out to produce results in accordance with the goals and objectives of the organization with predetermined performance standards. Professional human resources are those who have competence, in accordance with the profession they are engaged in. The goal to be achieved by human resource management is to form professional human resources, who have characteristics, are noble, competent, and motivated. Since entering the Millennium era, the world's development in the field of technology has been proceeding at high acceleration. Some countries that were once aligned both in the economic and industrial spheres are now lagging behind other countries. Rapid progress is because the mastery of technology is so good that it is able to compete globally. Mastering technology is an integral part of the ability of quality human resources which is greatly influenced by education and economic ability as a support. To support the competitiveness of the necessary identification and internalization of work attitudes in encouraging the competitiveness of the nation.

Keywords: HR, Competence, Competition



THE INFLUENCE OF THE INDEPENDENCE OF THE AUDIT COMMITTEE ON THE AGENT'S OPPORTUNISTIC BEHAVIOR

Idrisi Raliya Putra

STIE Ganesha, Economy, Jakarta, Indonesia

Abstract

This study was conducted to determine the effect of audit committee on earnings management and to determine differences in the level of earnings management between companies with audit committees that have the proportion of independence and competence of more than 50% and companies with audit committees that have the proportions of independence and competence of less than 50%. Agency theory is used as a framework for developing hypotheses. The variables observed in this study are the independence of the audit committee and earnings management with discretionary accruals as a proxy. The approach used in this research is a quantitative approach. The object of this research are 20 manufacturing companies listed on the Indonesia Stock Exchange for the period 2017-2018. The data used in this research is secondary data. The data used in this study were obtained from the Indonesia Stock Exchange website, the company's annual report. The tool used for the analysis of the observed variables is univariate ANOVA. The results of this study stated that: (1). The independence of the audit committee has a positive effect on earnings management; (2) Companies with audit committees that have the proportion of independence and competence of more than 50%, earnings manipulation behavior is lower than when companies with audit committees that have the proportions of independence and competence are less than 50%.

Keywords: Audit committee independence, Opportunistic Behavior, Discretionary Accrual

PRELIMINARY

This study investigates whether the audit committee plays a role in reducing the opportunistic behavior of agents proxied by discretionary accruals. A number of studies have been conducted regarding the association between institutional factors and earnings management or earnings quality (Leuz et al., 2003; Shen and Chih, 2005). Leuz et al. (2003) investigated whether variations in capital owner protection are associated with variations in earnings management. Meretia conducted investigations in 31 countries from 1990 to 1999. Confirmation of the data used states that the higher the investor protection, the lower the earnings management.

Shen and Chih (2005) also investigated the relationship between investor protection and earnings management. Meretia conducted investigations in 48 countries in the period 1993 to 1999. Confirmation from the data used states that the higher the investor protection, the lower the earnings management. The interpretation of the empirical confirmation of the two studies related to the relationship between investor protection and earnings management is that earnings management behavior can be limited by investor protection which is part of strong institutional factors. However,



the two studies above regarding the relationship between investor protection and earnings management still assume that the competence, independence, and professionalism of the audit committee are the same. In fact, the competence, independence and professionalism of the audit committee are different.

The audit committee is an important and inseparable component of the supervision of the company's financial reporting. The audit committee was formed to increase the accountability and transparency of the presentation of the company's financial statements and in turn reduce the risk of reputation and financial loss (Lian et al., 2017). In other words, the decline in earnings manipulation is caused by the protective role of investors or the role of a competent and independent audit committee. Therefore, it is still unclear whether the audit committee and investor protection influence the opportunistic behavior of agents.

Regulators around the world required the formation of audit committees, set up their structure and assigned supervisory responsibilities related to financial reporting, auditing, and internal financial controls, following the accounting scandals of the early 2000s. The accounting scandals that occurred in early 2000 included: (1) Worldcom; (2) Enron; (3) Tyco; (4) Adelphia.

The Chairman of the Financial Services Authority (OJK) of the Republic of Indonesia has also required the establishment of an audit committee for companies listed on the Indonesia Stock Exchange. This obligation is reflected in the issuance of regulations signed by the chairman of the financial services authority. The regulation in question is the regulation of the Financial Services Authority Number 55 /POJK.04/2015 concerning the formation and implementation guidelines of the audit committee. In line with the Financial Services Authority, Decree of the Board of Directors of PT BEI Number KEP-00001/BEI/01-2-14 of 2014 concerning Amendment to Regulation Number IA concerning Listing of Shares and Equity Securities other than Shares Issued by Listed Companies.

The regulation, which was issued on January 20, 2014 came into effect on January 30, 2014. The decision from the directors of PT BEI also emphasizes the obligation of public companies to have an audit committee. Decision of the Board of Directors of PT. IDX Number KEP-00001/BEI/01-2-14 and

regulations issued by the financial services authorities have determined that the Audit Committee shall consist of at least 3 (three) members who are Independent Commissioners and Parties from outside the Issuer or Public Company.

Decision of the Board of Directors of PT. IDX Number [KEP-00001/BEI/01-214](#) and Regulations issued by the financial services authority have determined that the Audit Committee shall consist of at least 3 (three) members from Independent Commissioners and Parties from outside the Issuer or Public Company. However, it is not clear how effective the regulations issued by the financial services authority of the republic of Indonesia and the decisions of the directors of the Indonesia Stock Exchange regarding the audit committee are because there has been no research confirming whether the regulations related to the audit committee are political (increasing public confidence in the capital market). or is efficient (able to mitigate the behavior of opportunistic agents). In other words, research related to the effectiveness of regulations issued by regulators - audit committees is still very interesting to do.

By considering, (1) The negative effect of agent opportunist behavior on the country's economy due to a decrease in trust when transacting in the market and in turn a decrease in the economy's wheels.



(2) There is no clarity regarding the role of investor protection against a decrease in agent opportunistic behavior because research still assumes an important role. from the audit committee, did not test, (3) there is not much empirical confirmation regarding audit committee regulations, whether they are political or efficient. Therefore, the researcher is interested in conducting a study entitled "the influence of the audit committee on the opportunist behavior of agents".

Review literature

Profit management

Earnings management can be viewed from a financial reporting perspective and a contract perspective. From a financial reporting perspective, managers can use earnings management to avoid poor reporting or to meet analyst earnings forecasts, thereby hoping to avoid a bad reputation and negative stock price reactions along with failure to meet investor expectations (Hong et al., 2014)

In addition, they may over-eliminate or emphasize earnings constructs other than net income, such as “pro-forma” earnings (Elshafie et al., 2010). Some of these tactics show that managers do not fully accept an efficient stock market, efficient markets assume that investors are rational and tend to see substance rather than form of disclosure.

From a contractual perspective, earnings management can be used as a way to protect firms from the consequences of unforeseen events when contracts are rigid and incomplete. However, earnings management behavior reduces the usefulness of financial statements. In other words, earnings management is a choice of accounting policies/procedures carried out by managers to achieve certain goals (Aminah and Faramitha, 2016).

Managers can use several earnings management techniques/patterns for specific purposes. Taking a bath, this technique is used when the organization is in a bad state, restructuring. Income-minimization, this technique is used for political or tax motives. Income-increasing, this technique is used for the motive of increasing bonuses (Rindengan, 2015).

Scott (2015: 16-18) Earnings management behavior can not be separated from the inequality of information and business between the manager and the principal (owner). In addition, there is an imbalance of interest between the manager and the principal (owner). According to Akerlof (Scott, 2015: 138) through the "lemon market" states that inequality in information results in adverse selection and moral hazard. Furthermore, the market will become inefficient and in turn will affect the economy of a country.

Audit Committee.

The audit committee is an important and inseparable component of the supervision of the company's financial reporting. They are formed and are responsible to the board of commissioners, assisting in carrying out the duties and responsibilities of the board of commissioners, one of which is in the process of supervising the financial (reporting) process (Financial Services Authority Regulation Number 55/POJK.04/2015 concerning the establishment and work implementation guidelines of the audit committee.). The main role of the audit committee is to oversee the financial reporting process and oversee the overall process to build good corporate governance (Siregar and Utama, 2006). In addition, other studies also confirm that the board of commissioners forms an audit committee to increase accountability and transparency in the presentation of the company's financial statements and in turn reduce the risk of reputation and financial losses (Lian et al., 2017).

The Financial Services Authority issued regulation No. 55/POJK.04/2015 concerning the establishment and guidelines for the implementation of audit committee work, which is a refinement



of Bapepam-LK regulation No. IX.I.5 regulates the audit committee (independence, tenure, and audit committee meetings). The regulation strengthens the role of the audit committee regarding its responsibility for the quality of financial reporting. The duties of the audit committee are as follows:

- a. To review the financial information to be issued by the company, such as financial statements, projections and other financial information;
- b. Reviewing the company's compliance with the laws and regulations in the capital market sector and other laws and regulations related to the company's activities;
- c. Reviewing the implementation of the audit by the internal auditor;
- d. Reporting to the commissioner's various risks faced by the company and the implementation of risk management by the board of directors;
- e. Reviewing and reporting to the board of commissioners on complaints related to issuers;
- f. Maintain the confidentiality of documents, data, and company secrets.

Dhaliwal et al. (2010) stated that the audit committee must have analytical skills in accounting so that it can assess the choice of accounting policies applied by management and in turn the resulting financial reports are of higher quality. In addition, they also state that audit committee members must have a strong understanding of finance so that they can effectively monitor and analyze the financial reporting process. Bédard and Gendron (2010) add criteria and state that the audit committee must also have members with financial expertise to identify and pose challenging questions to management and external audit so as to improve the quality of better financial reporting.

The characteristics of the main audit committee generally considered important to exert influence within the company and influence the results include expertise, independence, persistence and size (Bédard and Gendron, 2010). The expertise of audit committee members is likely to influence the level of monitoring provided on sustainability-related issues (Beasley et al., 2009). Erkens et al. (2015) stated that the audit committee must have members with financial literacy and at least one member is a financial expert.

Audit committees consisting of independent directors are not sequential, they are more informative and their disclosures are reliable (Al Shaer et al., 2017; Carcello et al., 2011; Pomeroy and Thornton, 2008). A less independent audit committee can hinder good corporate governance and in turn lead to poor performance because a less independent audit committee tends to be ineffective in questioning audit results (Al-Najjar, 2011).

The independent audit committee is expected to be able to evaluate the running of internal processes and reporting practices and also to question management's actions and policies, when needed (Beasley et al., 2009). We therefore expect independence to be an important criterion in audit committee membership. Previous research has established the importance of audit committees in overseeing the financial reporting process.

Audit committees consisting of three or more independent members receive more legitimacy and authority and in turn influence the top management team in monitoring (Abbott et al., 2004). UK Corporate Governance recommends that audit committees have at least three members as larger audit committees tend to be more powerful. Bédard and Gendron (2010) suggest that the audit committee must have two criteria, namely independence and competence.

In particular, independence and competence enable the audit committee to monitor effectively, i.e. strengthening auditor independence (various proxies are used such as avoiding auditor dismissal after going concern opinion, supporting auditors in disagreement with management, or agreeing to a lower NAS level) and audit quality (Different proxies are used such as selecting Big 4 or industry-specific auditors, or retaining a larger auditor employability level. Bédard and Gendron (2010)



suggest that “strong” (i.e. independent and financially competent) audit committees are more likely to choose an audit firm . qualified public accountants to obtain better audit quality (Big 4).

Based on the Financial Services Authority regulation Number 55/POJK.04/2015 concerning the establishment and guidelines for the work of the audit committee, the audit committee membership consists of at least three people including the chairman of the audit committee. There is only one member of this committee that comes from the commissioners, the committee members who come from the commissioners are independent commissioners of the listed company as well as the chairman of the audit committee. Other members who are not independent commissioners must come from independent external parties. Leonardo (2006) provides empirical evidence on the impact of audit committee composition and corporate management control on audit committee effectiveness based on a survey of corporate audit committees. They find evidence that audit committee composition has a significant positive impact on audit committee effectiveness.

Hypothesis Development

a. Effectiveness of the Audit Committee and Earnings Management

This study uses agency theory to develop hypotheses. Agency theory explains and predicts that agency problems often arise due to conflicts of interest between shareholders (principals) and managers (agents). The separation between ownership and management causes information asymmetry (adverse selection and moral hazard) and in turn opportunistic behavior.

To reduce information asymmetry and in turn opportunistic behavior , companies are required to provide financial reports to shareholders. However, when the financial statements provided by the company do not reflect the actual condition of the company, the decisions made by stakeholders tend to be inaccurate. Therefore, monitoring activities are needed to determine the company's financial reporting process so as to improve the quality of financial reports. One of the main keys is the function of the audit committee which functions as a supervisor and controller in assisting the board of commissioners in relation to financial reporting supervision. In order for the role as supervisor and controller of financial reporting to be effective, members of the audit committee must have competence (ie finance and accounting) and come from independent circles.

In short, agency theory predicts that high information asymmetry affects opportunistic behavior because of the incentives in the form of optimizing utility. To overcome information asymmetry and in turn opportunistic behavior, monitoring can be used. If earnings management reflects the opportunist concept of the theory and if the effectiveness of the audit committee reflects the concept of agency theory monitoring, the researcher suspects that the effectiveness of the audit committee affects earnings management behavior due to a decrease in opportunity (less information asymmetry) and a decrease in interest-incentives (large detectable cost) .).

In addition, the researcher also suspects that an audit committee with a composition according to regulations will be better at reducing earnings management behavior than an audit committee with a composition that is not in accordance with regulations. Therefore, the research assumptions are as follows:

H1: The independence of the audit committee has a positive effect on the decline in earnings management behavior

b. Audit Committee with (Non) Regulation and Management

The audit committee has an important role in corporate governance accountability because the committee's jurisdiction is to oversee and monitor the activities of the company's financial reporting system and internal and external audit processes.

The audit committee is an effective supervisor of the company's financial reporting and audit process, if: (1) Independent. The audit committee consists of outside directors who are more independent relative to inside directors; (2) Competent. Audit committee members have the



expertise, knowledge and competence of their members with respect to business matters and accounting and financial reporting, internal control, and auditing. For example, audit committee members have an understanding of how business activities are presented in financial statements and the ability to analyze these reports (financial reporting knowledge) and an understanding of the nature and objectives of financial statement audits (audit reporting knowledge).

Independent audit committee. An independent audit committee comes from outside the company. Independent audit committees tend to have the courage to report violations that occur in the financial reporting process compared to non-independent audit committees.

Incentives for committee members who come from outside the company to maintain independence, among others: (a) Audit committee members who come from outside the company have legal obligations to shareholders and can be held accountable if they fail to fulfill their obligations (Bahram, 2007); (b) Audit committee members from outside the company are more motivated to supervise managers than audit committee members from within the company because the managerial job market will discipline audit committee members from outside the company who fail to protect and enhance the interests of shareholders and in turn affect reputation. them (David Hay, 2014).

Competent audit committee. Competent audit committee members have the understanding and ability to detect violations that occur in the financial reporting process and in turn contribute to effectiveness compared to incompetent audit committees. In addition, a competent audit committee increases the incentive for external auditors not to behave opportunistically because when auditors realize that the audit committee does not understand technical issues, they are less likely to report the matter to the audit committee, thereby weakening overall corporate governance.

Therefore, an audit committee with a more dominant composition of independent and competent members tends to be better at supervising the financial reporting process than an audit committee with a less dominant composition of independent and competent members. In addition to the qualifications of the independent and competent audit committee members because they have the ability and courage to report violations that occur in the financial reporting process, they also have incentives to maintain competence and independence due to high reputation costs and lawsuits. Thus, the research assumptions are as follows:

H2: Audit committees with a composition according to regulations tend to be better at limiting earnings management behavior on an accrual basis than audit committees with compositions that are not in accordance with regulations

RESEARCH METHOD

Research Variables and Operational Definitions

This study investigates the influence of independent audit committees and earnings management as proxies for opportunistic behavior. The dependent variable (the dependent variable) in this study is earnings management. Meanwhile, the independent variable (unbound variable) in this study is the independence of the audit committee.

Dependent Variable

The dependent variable is the dependent variable whose value is influenced by the presence of other variables. The dependent variable in this study is earnings management.

Profit management



Earnings management in this study is defined according to the modified Jones model. This model believes that: (1) accounting profit consists of operating cash flows and total accruals; (2) total accruals consist of non-discretionary accruals and discretionary accruals; (3) non-discretionary accruals are a function of changes in income and total fixed assets owned, but to meet the assumption of heteroscedasticity lag total assets are used as denominators; (4) Meanwhile, discretionary accruals are the difference between total accruals and non-discretionary accruals and become a measure of earnings management.

The equations of the modified Jones model to obtain discretionary accruals are as follows:

- a) Calculate the total value of accruals

$NI_{it} = CFO_{it} + TAC_{it}$ (1) Description:

NI_{it} : Net profit after corporate tax I period t

CFO_{it} : Operating cash flow of company I period t

TAC_{it} : Total company accruals I period t

- b) Perform ordinary least square regression to obtain coefficients to calculate non-discretionary accruals using the following equation.

$TA_{it}/A_{it} = 1 (1/A_{it-1}) + 2 (REV_{it} - REC_{it}) / A_{it-1} + 3 (PPE_{it} / A_{it-1}) + \epsilon$ (2)

Information:

$Tait$: Total accrual of company i in year

$Ait-1$: Total Assets in period t-1

$REVit$: Income for period t minus period t-1

$RECit$: Receivables for period t minus receivables for period t-1

$PPEit$: Fixed assets in period t 1, 2, 3: Parameters of the company.

- c) Use the regression coefficient to obtain the value of discretionary accruals with the following equation:

$NDAit = 1 (1/Ait-1) + 2 (REVit - RECitt) / Ait-1 + 3 (PPEit / Ait-1)$ (3)

$NDAit$: Non-discretionary accruals accruals of company i in year t



Ait-1 : Total Assets in period t-1

REVit : Income for period t minus period t-1

RECit : Receivables for period t minus receivables for period t-1

PPEit : Fixed assets in period t
1, 2, 3: Parameters of the company

- d) Calculate the value of discretionary accruals which is a proxy for earnings management.

$$TAit/Ait-1 = NDAit + DAit \dots \dots \dots (4)$$

Information:

DAit : Discretionary accruals of company I period t

Independent Variable

The independent variable is an independent variable whose value is influenced by the presence of the dependent variable. The dependent variable in this study is the independence of the audit committee.

audit committee

The independence of the audit committee in this study is defined based on the applicable regulations (OJK Number 55 /POJK.04/2015 concerning the establishment and guidelines for the implementation of audit committee work). In line with previous studies conducted by Klein et al. (2000) and Dhaliwal et al. (2010). Klein et al. (2000) define the audit committee as a function of the independence of audit members and independence from economic factors. However, they also state that it is expensive for companies to maintain a 100% independent audit committee. Therefore, 51% of the independent committee members can be used as an alternative.

Dhaliwal et al (2010) stated the audit committee as a function of the competence of the members of the audit committee. They also stated that 51% of competent audit committee membership can be used to measure audit committee expertise. Thus, the researcher will give a score of 1 (one) if the audit committee consists of 51% of independent parties and 51% of competent parties. Meanwhile, if less than 51% of the membership is independent and competent, the research will give a score of 0 (zero).

Population and Research Sample

Sekaran (2000) states that the population is the sum of the entire group of individuals, events that attract the attention of researchers to be investigated or investigated. The population used in this study are manufacturing companies listed on the Indonesia Stock Exchange from 2017 to 2018.

The sample is part of the population (population elements) which are considered to represent the characteristics of the population. The sample used in this study was determined using purposive



sampling method. The purposive sampling method is a non-random sampling technique in which the researcher determines the sampling by determining specific characteristics that are in accordance with the research objectives so that it is expected to be able to answer research problems. The following criteria are used to determine the sample of this study:

- a. Companies classified as manufacturing companies and listed on the Indonesia Stock Exchange
- b. The company publishes a complete annual report for the period 2017-2018
- c. The company issues a corporate governance report for the period 2017-2018
- d. This study excludes companies that do not have sufficient data to calculate discretionary accruals.

Data collection technique

The data collection technique in this research is the documentation method. Documentation is the process of obtaining documents by collecting and studying the necessary documents and data. The document in question is a financial report.

The data used in this research is secondary data. Secondary data is quantitative data obtained indirectly and (or) through third parties. Meanwhile, the data sources of the variables observed in this study are the Indonesian Capital Market Directory (ICMD) and the Indonesia Stock Exchange (IDX) website. The data taken from the ICMD and IDX websites are financial reports. Financial statements contain financial information (quantitative) and non-financial information (qualitative). The elements of the financial statements will be used in the measurement, both the independence variable of the audit committee and the manipulation of earnings.

Data Processing Techniques

The analysis technique used in the research related to the influence of audit committee independence and earnings management is as follows:

Descriptive statistics

Descriptive statistics provide an overview or description of a data seen from the average value (mean), standard deviation, variance, maximum and minimum. In the context of this research, descriptive statistical analysis is used to describe the earnings management in manufacturing companies listed on the IDX.

Classic assumption test

1. Normality test



Imam Ghozali (2006) stated that normality testing was carried out to determine whether the residuals had a normal distribution. He also stated that the residual values in the t and F tests must be normally distributed, especially when the sample used is small. If the assumption of a normal distribution of residual values is not met, then the one-way ANOVA test is valid.

2. Heteroscedasticity Test

Ghozali (2006) states that for testing with One Way ANOVA the conditions that must be met are the same variance, other than the normal distribution. Heteroscedasticity test is used to determine whether the variance is the same or not. On the condition that the variable data has the same variance or p-value <0.05, the one-way ANOVA test is invalid, with exceptions.

3. Hypothesis testing

To examine the effect of the independent audit committee on earnings management, this study used a one-way ANOVA. The model used to test is as follows.

AcDisc_{it} = 0 + β₁ IKA_{it} + ε (5) Information:

AcDiscit : Value of discretionary accruals in year t company

IKAit: Independence of the audit committee in company I period t

: Error

ANALYSIS & DISCUSSION

In this section, the researcher will describe the results of statistical management and provide a discussion of these results. The sequence of discussion starts from the description of the results of data collection, classical assumption testing, data analysis in the form of one-way ANOVA results and a discussion of the influence of the independent variable on the dependent variable. In the context of this study, the independent and dependent variables used are the independence of the audit committee and earnings manipulation.

In this study, the population used are manufacturing companies listed on the Indonesia Stock Exchange (IDX). The number of registered manufacturing companies during the 2017-2018 period is around 150 companies. Based on the criteria that the researchers set, 20 companies that meet the requirements

Descriptive statistics

Descriptive statistics provide an overview or description of a data seen from the average value (mean), standard deviation, variance, maximum and minimum. This analysis was carried out before testing classical assumptions and testing hypotheses. In the following, the researcher presents the descriptive statistics on discretionary accruals and the independence of the audit committee.

**Tabel 4.1 Descriptive Statistics**

<i>Variable</i>	<i>N</i>	<i>Minimum</i>	<i>Maximum</i>	<i>Mean</i>	<i>Std. Deviation</i>
<i>DA</i>	39	,0033	,2111	,0846	,0513
<i>IKA</i>	39	,1500	,8300	,4690	,2915
<i>Valid N</i>	39				

Sumber: Data diolah dengan SPSS

Based on table 4.1, the value of discretionary accruals ranges from 0.0033 to 0.21110 with an average of 0.084626 and a standard deviation of 0.0512. While the percentage of competence and independence of the audit committee in each company is 0.15 to 0.83 with an average of 0.4690 and a standard deviation of 0.2914. The interpretation of these values is as follows:

1. audit committee. The percentage of competence and independence of the audit committee used as a mechanism for monitoring earnings management behavior ranges from 15% to 83% of the total audit committee members. From 39 observations, the average percentage of the audit committee is only 43% of the total audit committee members with a standard deviation of 0.29 . Based on the theory, if more than 50% of the audit committee members have competence and independence, the role as supervisor of the financial reporting process will be better than <50%. In other words, on average, the attention of manufacturing companies on the important role of the audit committee is still lacking because it is still below <50%.
2. Discretionary accruals. The value of discretionary accruals with the percentage of audit committees in the sample companies ranging from 15% to 83% is in the range of 0.003 - 0.211 with an average of 0.083. This means that the variation of the audit committee (15% to 83%) may result in variations in the value of discretionary accruals (0.003 to 0.211).

Classic Assumption Test

Ghozali (2006) stated that to perform a one-way ANOVA, the classical assumptions that must be met are normality and homogeneity (heteroscedasticity). Therefore, the researcher presents the results of normality and heteroscedasticity tests.

1. Normality test

Ghozali (2006) stated that the normality test was conducted to determine whether the data used in the study were normally distributed. Thus, the researcher conducted the Kolmogorov Smirnov test to determine whether discretionary accruals were normally distributed. Ghozali (2006) states that when the p-value is less than 0.05 then the data is not normally distributed, whereas when the p-value is more than 0.05 then the data is normally distributed and in turn the results of the f-test are valid.

**Tabel 4.2 One-Sample Kolmogorov-Smirnov Test**

		DA
<i>N</i>		39
<i>Normal Parameters a,b</i>	<i>Mean</i>	,08463
	<i>Std. Deviation</i>	,05125
<i>Most Extreme Differences</i>	<i>Absolute</i>	,095
	<i>Positive</i>	,095
	<i>Negative</i>	-,086
<i>Kolmogorov-Smirnov Z</i>		,591
<i>Asymp. Sig. (2-tailed)</i>		,875

Sumber: Data diolah dengan SPSS

Based on table 4.2, it is known that the significance value of Asymp.Sig (2-tailed) is 0.875, which is greater than 0.05 . So according to the basis of decision making in the Kolmogorov Smirnov normality test above, it can be concluded that the data are normally distributed.

2. Heteroscedasticity Test

Ghozali (2006) states that for testing with One Way Anova, the conditions that must be met are the same variance, in addition to the normal distribution. Heteroscedasticity test is used to determine whether the variance is the same or not. On the condition that the variable data has unequal variance or p-value < 0.05, then the one-way ANOVA test is invalid, while when the variance is the same and (or) p-value > 0.05, the one-way ANOVA test and results are valid. Here, the researchers present related to heteroscedasticity testing.

Tabel 4.3 Test of Homogeneity of Variances (DA)

<i>Levene Statistic</i>	<i>df1</i>	<i>df2</i>	<i>Sig.</i>
2,941	1	37	,095

Sumber: Data diolah dengan SPSS

Testing of the same variance (homogeneity) or unequal variance (heteroscedasticity) was carried out with the Levene test available in the SPSS software package. The results of the test state that the variance of the data used in this study is the same which is indicated by a p-value of 0.095 > 0.05. The interpretation of the results is that the data used in this study is valid for testing with one way ANOVA.

**HYPOTHESIS TEST**

1. Hypothesis Testing 1 (one) with Simple Linear Regression

Simple linear regression analysis was used to measure the effect of the independent variable on the dependent variable. It is said to be linear because each estimate of the value is expected to increase or decrease following a straight line. The first hypothesis states that the independence of the audit committee has a negative effect on earnings management. The explanations for these allegations include: (1) Agency theory predicts that agents tend to be opportunistic when information asymmetry is high because there are interest incentives for agents to do so; (2) Agency theory also suggests that monitoring can be used to reduce opportunistic behavior; (3) Therefore, if earnings management reflects the opportunist concept of agency theory and if the independence of the audit committee reflects the concept of agency theory monitoring, then the independence of the audit committee has a negative effect on earnings management.

In line with the explanation above, previous research has also confirmed through empirical research that an independent and competent audit committee has the ability to detect violations of disclosure and presentation of financial statements and has the courage to report violations that occur (Ronen, 2008). Meanwhile, previous research also stated that the tendency of agents to manipulate is motivated by high-interest incentives and low detectable cost incentives. In other words, if the ability to detect violations and the courage to report increases the likelihood of detecting earnings manipulation behavior and in turn reduces incentives for agents, then the independence of the audit committee has a negative effect on earnings management behavior. Therefore, the researcher will observe the pattern of the statistical results to determine the validity of the theory. The following presents the results of testing the effect of audit committee independence on earnings management using simple linear regression.

Tabel 4.4 Coefficients a

<i>Model</i>	<i>Unstandardized Coefficients</i>		<i>Standardized Coefficients</i>	<i>t</i>	<i>Sig.</i>
	<i>B</i>	<i>Std. Error</i>	<i>Beta</i>		
1 (Constant)	,154	,008		18,282	,000
IKA	-,149	,015	-,847	-9,700	,000

Sumber: Data diolah dengan SPSS

Based on the results of calculations using simple linear regression presented in table 4.4, the researcher interprets as follows: (1) the constant value is 0.154 where if there is no audit committee independence then the earnings management value is 0.154; (2) the regression coefficient for the independence of the audit committee is -0.149 and is negative where the more independent the audit committee is, the lower the earnings management behavior; (3) Table 4.4 is also presented regarding



the significance of the effect of the independence of the audit committee on earnings management with a value of 0.0001. The interpretation of these results is that the independent audit committee has an effect on earnings management because the value is < 0.05 . Overall, the results of simple linear regression confirm the researcher's assumption based on agency theory that audit committee independence has a negative effect on earnings management (ie p-value 0.0001 and audit committee independence coefficient -0.149).

2. Hypothesis testing 2 (two) with Anova One Way

The second hypothesis of this study states that an audit committee with a composition according to regulations tends to be better at reducing/limiting earnings management behavior on an accrual basis than an audit committee with a composition that is not in accordance with regulations. The explanation for the allegation is as follows:

- a. The audit committee has an important role in corporate governance accountability because the committee's jurisdiction is to oversee and monitor the activities of the company's financial reporting system and internal and external audit processes.
- b. The audit committee is an effective supervisor of the company's financial reporting and audit process, if:
 - (1) Independent. The audit committee consists of outside directors who are more independent relative to inside directors;
 - (2) Competent. Audit committee members have the expertise, knowledge and competence of their members with respect to business matters and accounting and financial reporting, internal control, and auditing. For example, audit committee members have an understanding of how business activities are presented in financial statements and the ability to analyze these reports (financial reporting knowledge) and an understanding of the nature and objectives of financial statement audits (audit reporting knowledge).
- c. Independent audit committee. An independent audit committee comes from outside the company. Independent audit committees tend to have the courage to report violations that occur in the financial reporting process compared to non-independent audit committees. Incentives for committee members from outside the company to maintain independence include:
 - 1) Audit committee members who come from outside the company have legal obligations to shareholders and can be held accountable if they fail to fulfill their obligations (Bahram, 2007);
 - 2) Audit committee members from outside the company are more motivated to supervise managers than audit committee members from within the company because the managerial job market will discipline audit committee members from outside the company who fail to protect and enhance the interests of shareholders and in turn affect reputation. them (David Hay, 2014);
 - 3) Competent audit committee. Competent audit committee members have the understanding and ability to detect violations that occur in the financial reporting process and in turn contribute to effectiveness compared to incompetent audit committees. In addition, a competent audit committee increases the incentive for external auditors not to



behave opportunistically because when auditors realize that the audit committee does not understand technical issues, they are less likely to report the matter to the audit committee, thereby weakening overall corporate governance.

Therefore, an audit committee with a more dominant composition of independent and competent members tends to be better at supervising the financial reporting process than an audit committee with a less dominant composition of independent and competent members. In addition to the qualifications of the independent and competent audit committee members because they have the ability and courage to report violations that occur in the financial reporting process, they also have incentives to maintain competence and independence due to high reputation costs and lawsuits. In the following, the test results and discussion related to the second hypothesis testing are presented.

Tabel 4.5 ANOVA

	<i>Sum of Squares</i>	<i>df</i>	<i>Mean Square</i>	<i>F</i>	<i>Sig.</i>
<i>Between Groups</i>	,060	1	,060	55,498	,000
<i>Within Groups</i>	,040	37	,001		
<i>Total</i>	,100	38			

Sumber: Data diolah dengan SPSS

Based on table 4.5 which is the output of SPSS, the researcher offers the following interpretation:

- a. Based on table 4.5, the degree of freedom (*df*) for the between group is 1 and the *df* for the within group is 37. The *df* 1 in the between group is obtained from the number of groups (2) – 1, with the audit committee according to regulations as the first group and the audit committee that unregulated as the second group. While *df* 37 in the within group is obtained from the number of observations (39) minus the number of groups (2).
- b. Based on table 4.5, the *F* value is 55,498. This value is obtained from the division of *Ms* in the between group (0.060) and *Ms* in the within group (0.00108).

Based on table 4.5, the *P*-value is 0.000. This value is obtained from the comparison of *F*count (87.863) and *F* table. If *f* count > *f* table then there is a tendency that the two groups being compared are statistically different. The interpretation of *p*-value 0.000 < 0.05 is that there is a difference in the value of discretionary accruals between audit committees that comply with regulations and audit committees that are not compliant with regulations and in turn reject *H*0



CONCLUSION

This study examines the effect of audit committee independence on the behavior of opportunistic agents in manufacturing companies listed on the Indonesia Stock Exchange for the 2017-2018 period. To determine the relationship between the observed variables, the researcher used 20 manufacturing companies as research samples. The tools used to analyze the correlation between the variables observed in this study, namely descriptive statistics, Kolmogorov-Smirnov test, Levene's test, and univariate analysis of variance. Based on the analysis and discussion presented in the previous chapter, it can be concluded that:

1. Earnings management behavior on an accrual basis in manufacturing companies listed on the Indonesia Stock Exchange still occurs. Descriptively, the research data shows that there is a variation of discretionary accrual values, ranging from 0.003 to 0.211 with an average value of 0.085.
2. The important role of the audit committee is still ignored by several manufacturing companies on the Indonesia Stock Exchange. The data from this study shows that in fifty percent (50%) of manufacturing companies listed on the Indonesia Stock Exchange, the proportion of independent and competent audit committee members is still below 50% of the total audit committee members they have.
3. In other words, earnings management behavior on accruals in manufacturing companies still occurs, perhaps due to the important role of the audit committee which is still being ignored.
4. Earnings management behavior in manufacturing companies that have a proportion of competent and independent audit committees more than 50% tends to be low. By regression, table 4.4 shows the regression coefficient of audit committee independence (IKA) is positive where when the proportion of competent and independent audit committee members is more than 50% as measured by 0, then the discretionary accrual value, as a proxy for opportunistic agent behavior, is also higher. small with pvalue < 0.05 . Furthermore, the analysis of univariate variance from table 4.5 also shows that there is a difference in discretionary accruals between companies with a competent and independent audit committee of more than 50% and companies with a competent and independent audit committee of less than 50% with F count 87.8 and p- values < 0.05 .
5. Earnings management behavior in manufacturing companies that have a proportion of competent and independent audit committees less than 50% tends to be higher. By regression, table 4.4 shows that the regression coefficient of audit committee independence is positive where when the proportion of competent and independent audit committee members is less than 50% as measured by 1, the discretionary accrual value, as a proxy for opportunistic agent behavior, tends to be more with p -value < 0.05 . In line with the regression analysis, the analysis of univariate variance in table 4.5 also shows that there is a difference in discretionary accruals between companies with a competent and independent audit committee of more than 50% and companies with a competent and independent audit committee of less than 50% with F count 87.8 and p-value < 0.05 .



6. Financial Services Authority Regulation Number 55/POJK.04/2015 concerning the establishment and work implementation guidelines of the audit committee which states that the audit committee consists of at least 3 (three) members who come from independent commissioners and parties from outside the issuer or public company. However, the regulation does not explain further about the competence of independent audit committee members. This study shows that the proportion of audit committee members who have a more dominant background, experience, and certification in accounting and finance tend to be more effective in carrying out their duties and responsibilities than vice versa.

Suggestions

Suggestions for further research include:

1. This study only uses manufacturing companies listed on the Indonesia Stock Exchange so that the results of this study cannot be generalized to companies other than manufacturing companies. Therefore, further research can investigate financial companies and (or) mining companies so that the explanation of agency theory will be more comprehensive.
2. This study only uses 20 companies as a sample so it may not be able to capture patterns from the data well. Therefore, further research can use a larger sample to be able to see the data better.
3. Finally, this study only uses earnings management measures on an accrual basis so it may not be able to comprehensively capture the opportunist behavior of agents. Therefore, perhaps further research can use measures of real earnings management and accrual earnings management in accordance with the recommendations of Roychowdhury (2006)

BIBLIOGRAPHY

- Abbott, LJ, Parker, S., & Peters, G. F, (2004), Audit Committee Characteristics and Restorations, *Auditing: A Journal Of Practice & Theory* , 23 (1), 69-87.
- Al-Najjar, B, (2011), The Determinants Of Audit Committee Independence and Activity: Evidence From The UK, *International Journal Of Auditing* , 15 (2), 191-203.
- Al-Shaer, H., Salama, A., & Toms, S, (2017), Audit Committees and Financial Reporting Quality, *Journal Of Applied Accounting Research* .
- Aminah, A., & Faramitha, C. Y, (2016), Relationship between Internal Control and Compensation with Accounting Fraud (Study on BPR in Lampung Province), *Journal of Accounting and Finance* , 7 (1).
- Beasley, MS, Carcello, JV, Hermanson, DR, & Neal, T. L, (2009), The Audit Committee Oversight Process, *Contemporary Accounting Research* , 26 (1), 65-122.



INTERNATIONAL ASIAN CONGRESS ON CONTEMPORARY SCIENCES – VII

- Bédard, J., & Gendron, Y, (2010), Strengthening The Financial Reporting System: Can Audit Committees Deliver?, *International Journal Of Auditing*, 14(2), 174-210.
- Carcello, J, V, C, Hollingsworth, and S, Mastrolia, (2011), “The Effect Of PCAOB Inspections On Big 4 Audit Quality”, *Research In Accounting Regulation* 23: 85–96
- Cohen, J. R., Krishnamoorthy, G., & Wright, A, (2004), The Corporate Governance Mosaic and Financial Reporting Quality, *Journal Of Accounting Literature*, 87-152.
- Dechow, Patricia, Richard Sloan, and Amy P, Sweeney, (1995), “Detecting Earnings Management,” *The Accounting Review* 70 (2):193–225.
- Dhaliwal, D. A. N., Naiker, V. I. C., & Navissi, F, (2010), The Association Between Accruals Quality and The Characteristics Of Accounting Experts and Mix Of Expertise On Audit Committees, *Contemporary Accounting Research*, 27(3), 787-827.
- El Diri, M. (2017). *Introduction to earnings management*. Springer.
- Elshafie, E., Yen, A. R., & Yu, M, (2010), The Association Between Pro Forma Earnings and Earnings Management, *Review Of Accounting and Finance*.
- Enomoto, Masahiro, Fumihiko Kimura, and Tomoyasu Yamaguchi, (2015), “Accrual-Based and Real Earnings Management: An International Comparison For Investor Protection”, *Journal Of Contemporary Accounting & Economics* 11 (3), Elsevier Ltd: 183–98.
- Ghosh, A., Marra, A., & Moon, D. (2010). “Corporate boards, audit committees, and earnings management: pre-and post-SOX evidence”. *Journal of Business Finance & Accounting*, 37 (9-10), 1145-1176.
- Hay, David, Knechel, W, Robert, and Willekens, Marleen, (2014), “The Routledge Companion To Auditing,” New York, NY: Taylor & Francis Books.
- Hong, Y., Huseynov, F., & Zhang, W., (2014), Earnings Management and Analyst Following: A Simultaneous Equations Analysis, *Financial Management*, 43(2), 355-390.
- Klein, A, (2000), Causes and Consequences Of Variations In Audit Committee Composition, NYU Law And Economics Working Paper No. 00-002
- Leuz, Christian, Dhananjay Nanda, and Peter D, Wysocki, (2003), “Earnings Management and Investor Protection: An International Comparison,” *Journal Of Financial Economics* 69 (3): 505–27.
- Lian, Q., Rupley, K., Wang, Q., & Zheng, L, (2017), Corporate Social Responsibility and Accounting Restatements.
- Pomeroy, B., & Thornton, D. B, (2008), Meta-Analysis and The Accounting Literature: The Case Of Audit Committee Independence and Financial Reporting Quality, *European Accounting Review* , 17 (2), 305-330.
- Rindengan, R. J, (2015), The Effect of Bonus Plans and Debt To Equity on Earnings Management (Case Study on Retail Trade Companies Listed on the Indonesia Stock Exchange), Doctoral Dissertation, Manado State Polytechnic.



INTERNATIONAL ASIAN CONGRESS ON CONTEMPORARY SCIENCES – VII

- Scott, William R, (2015), Financial Accounting Theory (7rd Ed), United States Of America: Pearson.
- Sekaran, Uma, (2000), Research Methods For Business, New York: John Wiley & Sons, Inc. Thirds. Edition.Imam Ghozali (2006).
- Siregar, SVN, & Utama, S, (2006), The Effect of Ownership Structure, Firm Size, and Corporate Governance Practices on Earnings Management, The Indonesian Journal of Accounting Research , 9 (3).
- Soltani, B. (2007). Auditing: An International Approach . Pearson Education.
- Turley, S., & Zaman, M, (2004), The Corporate Governance Effects Of Audit Committees, Journal Of Management and Governance , 8 (3), 305-332.
- Zuhri, AB, & Prabowo, TJ W, (2011), Effect of Free Cash Flow and Audit Committee on Earnings Management (Doctoral dissertation, Diponegoro University).



IMPULSIVE BUYING DECISIONS ON LIVE STREAMING SOCIAL COMMERCE

Syarif Hidayatullah

STIE Ganesha, Management, Jakarta, Indonesia.

Abstract

Social media users in Indonesia are growing rapidly, doubling from only 79 million in 2016 to 160 million users in 2020. Along with the proliferation of social media among internet users, its use has penetrated the e-commerce market. Online commerce is the online buying and selling of physical goods, a market in Indonesia consisting of approximately \$5 billion of formal e-tailing and more than \$3 billion of informal trade. It is estimated that there were around 30 million online shoppers in 2017. Social commerce, involves buying and selling physical goods through social media platforms. There was a threefold increase in trade through social commerce throughout 2020. This increase has occurred since the second quarter of 2020, which is the initial phase of the Covid-19 pandemic entering Indonesia and continues to grow increased sharply until the end of the fourth quarter of 2020 and early 2021. Indonesia is TikTok's second largest market in the world in 2020. There were 22.2 million monthly active users for the short video application in the country last year. Not just sharing videos, the TikTok application now also has a feature for online shopping called TikTok Shop. The problem in this study is that there is still a lack of research related to impulsive buying behavior in social commerce, especially in live streaming commerce. Existing research is dominated by China as the object of research. This is because live streaming commerce has grown rapidly in China, taking less than five years to develop into an innovative sales channel with an estimated 10 percent penetration. This study aims to determine the factors that influence impulse buying behavior on live streaming social commerce Tiktok Shop. This is expected to contribute to research on impulsive buying behavior on live streaming social commerce in Indonesia. In this study, data analysis will be carried out using the Structural Equation Modeling (SEM) method.

Keywords: social commerce, live streaming, impulse buying



EFFORT STENGTHEN TECHNOLOGY SKILL AND CAPABILITIES TO CREASE HR PRODUCTIVITY AND INNOVATION AFTER COVID 19

Elli Sulistyaningsih

Lecturer at Borobudur University

Abstract

Human resources are very important capital in development. Some developed countries in the world are able to achieve progress by relying solely on their human resources. Limited natural resources do not become a barrier for them to make their country one of the developed countries in the world.

Indonesia's large population is the basic capital for development on condition that it must be fostered.

Since entering the Millennium era, the world's development in the field of technology has been running at a high acceleration. The rapid progress is due to the excellent mastery of technology so that they are able to compete globally. Mastering technology is an integral part of the ability of qualified human resources which is strongly influenced by education and economic capacity as a supporter, so it is necessary to internalize work attitudes in encouraging the nation's competitiveness.

Keywords : Technology, Human Resource, Innovation

INTRODUCTION

Human resources are the driving force of a country, where the residents of the country concerned are those who carry out all state activities, such as politics, economics and others. In addition to running the wheels of government, the population also manages all natural resources that are wealth for the country concerned. Residents of a country with good quality will try to make the best use of existing natural resources, to meet the needs of life and improve welfare and be able to manage their country's wealth properly and efficiently.

The Covid pandemic is the worst global case since World War II (ILO 2020). Threat of mass layoffs, the Indonesian economy fell to 5.32 in the second quarter of 2020. Economic growth in the first quarter of 2021 began to turn positive at -0.74 percent, from -2.19 percent in the fourth quarter of 2020.

HR is the key that determines the development of the company. In essence, human resources are in the form of humans who are employed in an organization as movers, thinkers and planners in order to achieve organizational/company goals.

Based on data from the Ministry of Manpower and Transmigration in 2013, Indonesia has a population aged 15 years and over as many as 176,662,097 people. The total workforce reached 118,192,778 people with the Labor Force Participation Rate (TPAK) reaching 66.9%. This means that in 2013, as many as 66.9% of the working age population were involved or tried to be involved in productive activities. With the existing human potential, Indonesia should be able to progress and develop again so that people can live more prosperously.



INTERNATIONAL ASIAN CONGRESS ON CONTEMPORARY SCIENCES – VII

In an environment where workforce challenges are constantly changing, laws are changing, and the needs of employers are also changing, then HR must continue to change and evolve and company managers must select the right employees or workforce who can help the company.

Based on research from the World Bank in 2018, Indonesia's Human Capital Index (HCI) is ranked 87 out of 157 countries. Indonesia's HCI value is 0.53 behind several Southeast Asian countries. The increasingly sharp business competition demands that the organization/company be managed professionally in order to be able to survive and continue to grow in the long term. In addition to technology capital, finance, operating systems and of course human resources are the determining factors. The quality of human resources significantly determines the success of a company. Human Development and Mastery of Science and Technology including Education and culture, Health and Employment also need to be improved. In the context of economic development, human capital is the "goal" of development itself. Human capital is seen as a "way" because through improving the quality of human capital sustainable economic growth can continue. While economic growth is a mandatory condition of economic development.

Human capital is seen as a goal because it reflects the most basic development goals.

Vision Indonesia 2045 To realize the Unitary State of the Republic of Indonesia which is independent, united, sovereign, just and prosperous.

4 Pillars of Indonesia's 2045 Development

- Human Development and Mastery of Science and Technology
- Sustainable Economic Development
- Development Equity
- National Resilience Consolidation

These four pillars are built on Pancasila and the 1945 Constitution as the basis of being a nation and state and, with the aim of proving the Indonesian nation and all of Indonesia's bloodshed and to promote public welfare, educate the nation's life, and create a world based on independence, eternal peace and social justice.

Today all aspects of life to compete show the best, because it is the best that can survive to remain competitive in the stage of globalization. an organization that must prepare itself to face global challenges and competition. The rapid development of world business has led to intense market competition. Many businesses have sprung up that produce and offer products with new creativity and innovation, so that competition is unavoidable. If business actors do not try to be creative and innovative themselves in producing products, the business will be run over by other competitors. Humans actually play a big role in an organization or company. Humans are the driving force for all components in the organization, so humans are the spearhead of the overall management of the organization.

To make changes in a positive direction, it takes humans and humans who are able to find the right and unique strategy to choose competition. As is known in the organization, there is one element, namely humans who are the driving force of an organization and most play a role in determining the success or failure of the organization's goals and most play a role in determining or not the goals of the organization. Human resources or those mentioned play a role in planning, implementing, controlling and controlling the organization for the maximum vision and mission. Therefore, to be able to run the organization well, the human must be creative, innovative, and productive.

Without creativity and innovation, the organization will be underdeveloped and its performance will always be in the public spotlight. Therefore, creativity and innovation in every organization that



INTERNATIONAL ASIAN CONGRESS ON CONTEMPORARY SCIENCES – VII

wants to advance must first strengthen internally, so that when internally it is strong and produces organizational products that are ready and solid, automatically when facing external problems the organization can be overcome.

Organizations must instill a supportive work culture as the creation of new creativity and innovation. One way is to empower human resources to always be critical and follow up on their critical nature with concrete actions to quickly resolve the problems they face. Then the attitude is given the opportunity to carry out the process of self-actualization.

President Joko Widodo Initiates Indonesian Dream 2015 – 2045

Indonesian human resources whose intelligence outperforms other nations in the world

Indonesian people who uphold pluralism, culture, religion and uphold ethical values,

Indonesia is the center of education, technology and world civilization,

Society and government apparatus free from corrupt behavior

The construction of infrastructure that is evenly distributed throughout Indonesia

Indonesia is becoming an independent country and the most influential country in Asia Pacific

Indonesia is a barometer of world economic growth

Investment in development, one of the capital for humans can be done through education.

Education plays a very significant role in the development process. Because through education the continuity of technological innovation is possible to continue to increase from time to time. The better the quality of education in a country, the better the level of human resources owned by that country. The availability of reliable human resources is the capital for ongoing scientific research activities whose findings can be used to support the rate of economic growth (Todro and Smith, 2011: 359)

Human resources are the driving force of a country, where the residents of the country concerned are those who carry out all state activities, such as politics, economics and others. In addition to running the wheels of government, the population also manages all natural resources that are wealth for the country concerned. Residents of a country with good quality will try to make the best use of existing natural resources, to meet the needs of life and improve welfare and be able to manage their country's wealth properly and efficiently.

In an environment where workforce challenges are constantly changing, laws are changing, and the needs of employers are also changing, then HR must continue to change and evolve and company managers must select the right employees or workforce who can help the company.

Based on research from the World Bank in 2018, Indonesia's Human Capital Index (HCI) is ranked 87 out of 157 countries. Indonesia's HCI value is 0.53 behind several Southeast Asian countries. The increasingly sharp business competition demands that the organization/company be managed professionally in order to be able to survive and continue to grow in the long term. In addition to technology capital, finance, operating systems and of course human resources are the determining factors. The quality of human resources significantly determines the success of a company. Human Development and Mastery of Science and Technology including Education and culture, Health and Employment also need to be improved. In the context of economic development, human capital is the "goal" of development itself. Human capital is seen as a "way" because through improving the quality of human capital sustainable economic growth can continue. While economic growth is a mandatory condition of economic development. Human capital is seen as a goal because it reflects the most basic development goals.



Current technological developments give birth to new ways of completing work in various sectors such as manufacturing, banking, services and so on. This condition then demands the existence of human resources (HR) who are creative, innovative and competitive.

Without creativity and innovation, the organization will be underdeveloped and its performance will always be in the public spotlight. Therefore, creativity and innovation in every organization that wants to advance must first strengthen internally, so that when internally it is strong and produces organizational products that are ready and solid, automatically when facing external problems the organization can be overcome.

Organizations must instill a supportive work culture as the creation of new creativity and innovation. One way is to empower human resources to always be critical and follow up on their critical nature with concrete actions to quickly resolve the problems they face. Then the attitude is given the opportunity to carry out the process of self-actualization.

President Joko Widodo Initiates Indonesian Dream 2015 – 2045

Indonesian human resources whose intelligence outperforms other nations in the world
Indonesian people who uphold pluralism, culture, religion and uphold ethical values,
Indonesia is the center of education, technology and world civilization,
Society and government apparatus free from corrupt behavior
The construction of infrastructure that is evenly distributed throughout Indonesia
Indonesia is becoming an independent country and the most influential country in Asia Pacific
Indonesia is a barometer of world economic growth

Investment in development, one of the capital for humans can be done through education. Education plays a very significant role in the development process. Because through education the continuity of technological innovation is possible to continue to increase from time to time. The better the quality of education in a country, the better the level of human resources owned by that country. The availability of reliable human resources is the capital for ongoing scientific research activities whose findings can be used to support the rate of economic growth (Todro and Smith, 2011: 359)

Professional HR are those who have competence, according to the profession they are engaged in. The goal to be achieved by human resource management is to form professional human resources who have characteristics, have noble character, are competent, and hopeful.

THEORETICAL REVIEW

Sonny Sumarsono (2003)

According to him, human resources have two different meanings, including:

HR is a work business or service that is indeed provided with the aim of carrying out the production process. In other words, Human Resources is the quality of the effort a person does within a certain period of time in order to produce services or goods.

Still related to the first thing, the second understanding of HR is where humans are able to work to produce a service or goods from the work effort, Being able to work means being able to carry out various activities that have economic value or in other words, these activities can produce goods and services for meet the necessities of life.

MTE Hariandja (2007)

That human resources are one of the most important factors in a company in terms of other factors besides business capital. Therefore, HR is needed to be managed properly so that the effectiveness and efficiency of the company will increase.

Rogers (1994)



Rogers quoted from a book issued by Seels and Richey in 1994 said that technology is a design of instrumental steps to reduce doubts about causal relationships in achieving the expected results.

Saliman and Sudarsono (1993) Other figures who provide a definition of technology are Saliman and Sudarsono (1993). Saliman and Sudarsono said that technology is a science that studies development and industry.

In simple terms, the definition of technology is all kinds of facilities and infrastructure made by humans to produce functional objects. Thus, the survival and comfort of humans can feel better than before.

Definition of Competency



METHODOLOGY

This research method uses survey research methods with the research field for academics with the aim of research as applied research where research is carried out with the aim of applying, testing and evaluating the ability of an applied theory in solving practical problems. Then according to the level of explanation this research is an associative research. Associative research is research that aims to determine the relationship between two or more variables with a descriptive approach

Regression analysis according to Riduwan and Engkos A. K. (2012, p. 4), is used to predict (predict) the dependent variable (Y) if the independent variable (X) is known. Multiple linear regression analysis is used to analyze the dependence of the variable (Y) on a number of independent variables (X) or to find out how much influence several independent variables X has on the dependent variable Y. The equations of the Multiple Linear Regression Analysis Method are as follows:

$$\hat{Y} = b_0 + b_1X_1 + b_2X_2 + b_3X_3$$

\hat{Y} = productivity

b_0 = Number of Constants (intercepts)

$b_{1,2,3}$ = Regression coefficient (estimator) measures the magnitude of the influence X against Y, if X rises by one unit

X_1 = technology reinforcement

X_2 = hr potential

X_3 = innovation

The calculation of the simple correlation coefficient (Product Moment correlation) is as follows (Sugiyono, 2005, p. 182):

$$r_{xy} = \frac{\sum xy}{\sqrt{(\sum x^2) (\sum y^2)}}$$

r = Product Moment Correlation



x = Independent Variable

y = Bound Variable

The calculation of the coefficient of multiple correlation is as follows (Sugiyono, 2005, p. 190)

$$R_{y.x_1x_2} = \sqrt{\frac{r^2_{yx_1} + r^2_{yx_2} - 2r_{yx_1}r_{yx_2}r_{x_1x_2}}{1 - r^2_{x_1x_2}}}$$

$R_{y.x_1x_2}$ = Correlation between variables X1 and X2 together-equals variable Y

r_{yx_1} = Product Moment Correlation between X1 and Y

r_{yx_2} = Product Moment Correlation between X2 and Y

$r_{x_1x_2}$ = Product Moment Correlation between X1 and X2

According to Sugiyono (2005, p. 183), the classification of the relationship between variables is stated in the correlation coefficient which can be explained as follows:

Relationship coefficient: 0.00-0.199 = very low

Interval coefficient : 0.20-0.399 = low relationship

Interval coefficient : 0.40-0.599 = moderate relationship

Interval coefficient : 0.60-0.799 = strong relationship

interval coefficient : 0.80-1000 = very strong

Furthermore, to test the significance of the independent influence variable on the dependent can be accepted or not tested using the t-test using the Sugiyono formula (2005, p. 214) as follows:

$$t = \frac{r\sqrt{n-2}}{\sqrt{1-r^2}}$$

t = calculated t value

r = partial correlation

n = number of observations

Then the calculated t price is then compared with the t table price. For the 5% error, the two-party test and $dk = n - 2$. Provided that if t count is less than t table, then H_0 is accepted and rejected or less than 0.05. On the other hand, if r count is greater than t table (t count > t table) then H_a is accepted. This means that the correlation coefficient found is significant. Significant means that the coefficient can be generalized to the population.

Test the correlation coefficient using the F test using the F arithmetic formula (Sugiyono, 2005, p. 219), as follows:

$$F = \frac{R^2 / (k-1)}{(1 - R^2) / (n - k)}$$

For F of the table, the degree of freedom (degree of freedom) of the numerator = (k - 1 (k = number of variables), for the denominator (n - k), at the degree of confidence (degree of freedom) = 95 % (2 tailed)



Table
Partial Correlation Test Results
Correlations

		TECHNOLOGY	HR	INNOVATION	PRODUCTIVITY
TECHNOLOGY	Pearson Correlation	1	0,404**	0,240*	0,544**
	Sig. (2-tailed)		0,000	0,042	0,000
	N	72	72	72	72
HR	Pearson Correlation	,404**	1	0,302*	0,607**
	Sig. (2-tailed)	0,000		0,010	,000
	N	72	72	72	72
INNOVATION	Pearson Correlation	0,240*	0,302*	1	0,511**
	Sig. (2-tailed)	0,042	0,010		0,000
	N	72	72	72	72
PRODUCTIVITY	Pearson Correlation	0,546**	0,607**	0,511**	1
	Sig. (2-tailed)	0,000	0,000	0,000	
	N	72	72	72	72

** . Correlation is significant at the 0.01 level (2-tailed).

* . Correlation is significant at the 0.05 level (2-tailed).

The table above explains that the partial relationship between work discipline variables and employee performance is significant with a value of 0.000 with a fairly strong correlation value of 0.544, the partial relationship between work environment variables and employee performance is significant with a value of 0.000 with a fairly strong correlation value, namely 0.607 and the partial relationship between work motivation variables on employee performance is significant with sig 0.000 with a fairly strong correlation value of 0.511.

FINDING AND DISCUSSION

The role of human resources is emphasized in the outline of state policy that the essence of Indonesia's national development is to build a complete Indonesian nation and all Indonesian people. In addition, in the general pattern of long-term development II, it is also emphasized that the main goal of national development is to improve the quality of the Indonesian people. Human resources are the driving force of a country's activities, where citizens play a role in carrying out all state activities, such as politics, economics and others. In addition to running the government, citizens also manage all natural resources that become wealth for the country concerned.

The government targets that Indonesia's economic growth can remain positive in the second and third quarters of 2020 at the threshold of 2.3%-2.5%. The implementation of the new normal is expected to support this economic growth. With the operation of the industrial sector, the economy can revive and control economic growth. The new life order or the new normal is a discourse launched by the government to restore people's productivity and make economic conditions vibrant again. The new normal is one option to become a milestone in Indonesia's economic revival. Through the new normal, the government and the community work together to restore the economic and social conditions of the community. However, on the other hand, all parties are expected to continue to try to stop the spread of the Corona virus.

Basically, human resources (HR) play an important role as a driving force for all parts of the organization. Therefore, to be able to make organizational changes in a more positive direction, reliable human resources are needed to be able to win the competition in this global era. Human Resources / called employees have a role in planning, implementing, controlling, and controlling the organization for the sake of the maximum organization within the organization itself. The main function of HR in an organization, so to run the organization well, the human must be productive and innovative.



The concept of productivity with efficiency and effectiveness (Gomes, 2000). Meanwhile, productive employees are those who have innovation and cultivate skills in order to make the most of their working time and opportunities. In a broader sense, innovative employees are those who can 'create' and not just 'do'. So the next question is, how can companies recognize the characteristics of employees who have such talent? An expert suggests that the characteristics of a productive employee are:

First, high productivity is impossible to achieve if employee qualifications are low. In the sense that the employee must meet the qualifications as an intelligent individual and can learn quickly about new things. On the other hand they must be competent professionally or from a technical point of view. They must be able to understand day-to-day work and be able to do work in a “smart” way, use logic, organize work efficiently, always pay attention to design performance, quality, safety, cost, and scheduling. They should also always have a desire to improve themselves.

Second, they are highly motivated individuals, in the sense that these employees must be able to motivate themselves consistently, be diligent in doing their work, work effectively with or without superiors, take the initiative in seeing things that must be done and take necessary actions, like challenge and don't just want to be in a comfort zone, have curiosity. On the other hand, they are also goal-oriented or result-accomplished, always on time, contributing more than expected by the organization.

Third, they must have a positive job orientation. This can be observed from how they like their work and are proud of it, set high standards in every result they do. In their work they will be careful, trustworthy, and consistent, in the company they will respect management and its goals and have a good relationship with management. They can also receive direction from others, are also flexible and can adapt to various situations.

Fourth, mature. In this case, mature employees show consistent performance. Employee maturity can be observed by seeing whether they have a strong sense of responsibility for their work, knowing their own weaknesses or strengths and then making improvements. Independent, confident, and self-disciplined. On the other hand, they can work effectively under pressure, can learn from personal experience and others and have strong ambitions.

Fifth, they can socialize well, namely they have a pleasant personality, can communicate effectively (clear and thorough, open to suggestions and good listeners), demonstrate a positive attitude and enthusiasm at work.

Meanwhile, to find out which employees are innovative can be done in a fairly easy way, namely by observing and paying attention to the work attitude and impact of each employee. Innovative employees usually do not just follow the rules, but also take part in making/formulating a rule to increase work productivity. Innovative employees will tend to make changes, think outside the box and not only support the changes created by others. Innovative employees will provide information in the form of data from the side of their ideas/creativity to form important new things and bring changes for the better. Innovative employees will inspire and motivate other employees. If the employee characteristics above are found, the company must be able to hone, direct and optimize their skills in order to bring the organization to the maximum achievement of the goals that have been set.

Micro, Small and Medium Enterprises (MSMEs) are an important part of the economy of a country, although judging from the small scale of the economy, the number of Micro, Small and Medium Enterprises (MSMEs) is very large and dominant and the contributions made so far are both for the



community and for the state. This important role has encouraged many countries including Indonesia to continue to develop Micro, Small and Medium Enterprises (MSMEs), namely: First, because the performance of Micro, Small and Medium Enterprises (MSMEs) tends to be better in terms of producing a productive workforce. Second, as a part of its dynamics, Micro, Small and Medium Enterprises (MSMEs) often achieve increased productivity through investment and technological change. The third is because it is often believed that Micro, Small and Medium Enterprises (MSMEs) have an advantage in terms of flexibility over large businesses.

The development of the creative economy in Indonesia is often referred to as one of the backbones The national economy is the process of creating, producing and distributing goods and services, which in the process requires creativity and intellectual ability.

The creative economy sub-sector in Indonesia, including the following:

1. Game Developer

The local game industry and ecosystem have great potential to contribute to the country's creative economy. There are many opportunities that can be explored, both as makers and professional players, considering that Indonesia's demographics are getting more productive segments and the number of middle income classes is high.

2. Architecture.

In terms of culture, the diversity of local and regional architecture shows the character of the Indonesian nation which has a variety of cultures. Meanwhile, in terms of development, architecture also plays a role in designing the basis for the development of a city. Because the potential is huge.

3. Interior Design

The use of interior designer services to design the interior aesthetics of residential, hotel, and office buildings is increasing. It is clear that the economic potential of the interior design industry is very promising. "It can be a positive momentum for the interior design sub-sector that should not be wasted. The emergence of various schools, consultants, companies, and interior design associations shows the spirit of this sub-sector to develop in national and even international markets.

4. Music

Music is a promising industry in the world of showbiz. The great interest and enthusiasm of young musicians to enter this field shows that music has the potential to become a bigger industry.

5. Fine Arts

In this sub-sector, Indonesia has the greatest potential in terms of quality, quantity, creative actors, productivity, and market potential. Indonesian fine arts also already have a very strong network both domestically and abroad. Various fine arts festivals are held regularly, even those whose reputation is recognized internationally.

6. Product Design

Product design is the process of creating a product that combines elements of function with aesthetics so that it is useful and has added value for the community. The product design sub-sector is also supported by industry players who have reliable craftmanshifts. The product designers are able to explore and elevate local wisdom, the diverse richness of Indonesian culture, in each of their works.

7. Fashion

Fashion trends are always changing rapidly. In a matter of months, new fashions always appear. This cannot be separated from the productivity of innovative local fashion designers in designing new models of clothes, and the emergence of a creative young generation who is enthusiastic about this fashion industry. Society as a market is also getting smarter and more tasteful in choosing fashion.

8. Culinary

The culinary industry has a very strong potential to develop, therefore the government will support this sub-sector to be more advanced. Several culinary industry players see that there are several things that need to be improved and managed more seriously. One of them is the need for



access to business licenses through one door so that it is easier and more effective. New culinary businessmen should get guidance from the government, ranging from business training, licensing information, to legal assistance in the business establishment process.

9. Movies, Animations and Videos

The film, animation, and video sub-sectors have the potential to be developed for the better, although they still have to face various challenges. Some of them are the lack of human resources who really have expertise in the field of film, so the options for getting a team of directors, screenwriters, crew, and film players, are very limited.

10. Photography

The development of this sub-sector is supported by the increasing interest of young people in photography, along with the development of social media and increasingly affordable equipment.

11. Visual Communication Design

The potential of visual communication design still has to be improved, as is market awareness of the importance of design. The work of graphic designers is often valued at a price that is not worth it. In fact, graphic designers need a fairly long process in their work, from thinking about philosophy, processing designs so that they have meaning, and producing finished products.

12. Television and Radio

Although not as advanced as cell phones and other devices, television and radio still have a very large role in disseminating information. Currently, ownership of television and radio is evenly distributed, so that every level of society can access this technology.

13. Advertising

Advertising is a sub-sector of the creative economy whose work has the highest spreadability.

14. Indonesian Performing Arts

Indonesia has a wealth and diversity of performing arts and traditions, such as wayang, theatre, dance, and others that have been recognized and appreciated by the international community.

15. Publishing

The publishing sub-sector plays a role in building the nation's intellectual strength and continues to strive to adapt to the times. Plus the development of technology that allows books to be published in digital form.

16. Application

Along with the increasing penetration of smartphones, the application development industry is increasing and becoming a sub-sector with great potential in the future.

Facing the new normal situation, MSME/IKM actors have begun to turn their attention to the virtual world as well as business actors. Increased use of the internet, accelerates the movement of businesses towards e-commerce. Buyers get a lot of benefits and convenience with the use of the internet and sellers do not need to have a physical store, which means it can reduce operational costs. MSME/IKM actors are starting to look for a way out so that the wheels of business production continue to move, one of which is by utilizing internet media. Utilization of the internet by using an e-commerce platform is an option to continue doing business activities. E-commerce strategy is an integral part of the competitive profile, while system stability, system security and system speed are considered as facilitators in the implementation of e-commerce operations. E-commerce strategies that can be used as a reference:

1. Commitment - The desire for a growing business and the commitment of the business owner to determine the success of e-commerce. The motivation of business owners can be seen from the readiness of business actors to adapt to technology and market changes. They are also open to the latest ideas, technologies and business opportunities. If needed, business owners can look for financiers who can provide the right technology, funding, management expertise and contacts so that the business can grow quickly.



2. Content - The content of a site must be accurate, informative, updated, easy to understand even for lay people and most importantly relevant to customer needs.
3. Convenience - refers to the development of web design design paying attention to user-friendly interfaces. As much as possible everything that customers need is contained on the site such as location maps, audio, video and so on. However, it is the use of menus like this that site designers must pay attention to because using animation effects can affect loading time.
4. Interaction - Customers expect high quality interactions with sellers/business actors, especially in the service sector. Good performance from activities like this has proven to be effective in gaining consumer trust and loyalty.
5. Controls - Control factors are needed to evaluate online sales systems to track and respond to customer inquiries, handle complaints, feedback and product returns, control the entire order fulfillment process, update Web content, process online transactions and control credit risk. If online sellers can't control everything, they can be sure that their customers will look for other online sellers who can provide these services.
6. Communities are needed to exchange relevant information, products and services that can be done through applications such as blogs, forums and so on. Sellers can enter the community that is relevant to the product they produce, penetrate the market and introduce products in a community or sometimes become a sponsor in an event organized by the community.
7. Price - Customers tend to look for lower prices on the web, so customers will compare the price of a product offered by several sellers. Therefore, the seller will reduce some of his profits in order to survive competing with other sellers. However, certain products that are not widely available will incur additional fees for special services.
8. Brand image - Building an image is important for business actors to be able to compete with other traders, especially on the internet.
9. Partnership - For SMEs, partnerships are needed to develop businesses, because with partnerships, SMEs can use the resources of partner companies.
10. Process improvement - The use of information technology in business processes, especially Business Process Re-engineering (BPR) to automate processes within an organization in order to achieve greater operational efficiency and be ready to cope with the rapid growth in the volume of e-commerce transactions.
11. Integration - Electronic Data Interchange (EDI) integration system is needed if the transactions that occur in e-commerce are relatively large, therefore a server with large capacity is also needed so that transactions can run smoothly. The need for servers with large capacities is certainly not suitable for MSMEs, unless they get assistance from technologically advanced partners.

As a result of the pandemic, the number of sellers selling online has increased to 3.5 million at Bukalapak & Tokopedia. The government has been trying to get MSMEs to sell on e-commerce platforms since before the pandemic hit the world, and has continued to increase since the pandemic. Based on data from the Ministry of Cooperatives and SMEs, there are 1,415,602



MSMEs joined digital platforms such as e-commerce, Gojek, Grab and others as of the end of July, so around 9.4 million MSMEs in Indonesia are already selling online.

Marketplace can traditionally be likened to a marketplace that connects sellers and buyers, only this is happening in cyberspace. Marketplace acts as a third party in online transactions that provides a place to sell and payment facilities. Each marketplace has its own market. Shopee, for example, is known as a marketplace for fashion and beauty products.

An online shop or online shop is different from a marketplace. Online shops do not use intermediaries, but directly sell their products directly to customers. Selling products directly can be done through the website, social media or directly dealing with consumers. Some examples of online shops are Rabbani, Bukupedia, and Babyzania.

Since entering the Millennium era, the world's development in the field of technology has been running at a high acceleration. The rapid progress is due to the excellent mastery of technology so that they are able to compete globally. Mastering technology is an integral part of the ability of qualified human resources which is strongly influenced by education and economic capacity as a supporter. To support the competitiveness of the necessary identification and internalization of work attitudes in encouraging the nation's competitiveness.

RESULTS

Shows that training has a real effect on improving the quality of human resources the better through training activities, when hr development is carried out, the quality of workers is getting better, as a result of efforts to repay services are carried out properly. The development of human resources needs to be through the right method, so that the company can have reliable employees to help the company. The methods of hr development include training or training.

CONCLUSION

Since entering the Millennium era, the world's development in the field of technology has been running at a high acceleration. Some countries that were once well aligned in economics and industry are now lagging behind others. The rapid progress is due to the excellent mastery of technology so that they are able to compete globally. Mastering technology is an integral part of the ability of qualified human resources which is strongly influenced by education and economic capacity as a supporter. To support the necessary competitiveness and internalization of work attitudes in encouraging the nation's competitiveness.

The tight competition makes companies want to provide advantages and gain profits for the company, for this reason, efforts are made to stay afloat in the face of competition.

Therefore, companies must adapt to existing business developments. In facing competition, companies need an integrated and appropriate strategy, so that companies can anticipate the impact of an event and are able to act proactively and innovate to maintain and improve competitive ability. To achieve the right business strategy, an easy job for companies in the face of competitors. Therefore, companies must be able to compare their products, prices, distribution channels and promotions with those of their closest competitors.

Therefore, to be able to make organizational changes in a more positive direction, reliable human resources are needed to be able to win the competition in this global era. Human resources/ called employees have a role in planning, implementing, monitoring, and controlling the organization for the maximum achievement of the mission within the organization itself. Thus the main function of



HR in an organization, so that to be able to run the organization well, the human must be productive and innovative.

Micro, Small and Medium Enterprises (MSMEs) are an important part of the economy of a country, although judging from the small scale of the economy, the number of Micro, Small and Medium Enterprises (MSMEs) is very large and dominant and the contributions made so far are both for the community and for the state. This important role has encouraged many countries including Indonesia to continue to develop Micro, Small and Medium Enterprises (MSMEs), namely: First, because the performance of Micro, Small and Medium Enterprises (MSMEs) tends to be better in terms of producing a productive workforce. Second, as a part of its dynamics, Micro, Small and Medium Enterprises (MSMEs) often achieve increased productivity through investment and technological change. The third is because it is often believed that Micro, Small and Medium Enterprises (MSMEs) have an advantage in terms of flexibility over large businesses.

The ability to think of humans is a very important natural resource, because thinking is the main foundation for culture. Humans as cultured living beings, are able to process natural resources for the benefit of their lives and are able to change the state of natural resources thanks to advances in science and technology.

The need for technology, both information and communication technology is very high. All individuals really need technology to accelerate development for both the individual and the group.

Organizations/Companies need to change their mindset from surviving to growing during and after the covid 19 pandemic. In a survival mindset, seeing disruption as a crisis but at the same time being able to return to business as usual. Meanwhile, the developing mindset can make peace by realizing that the crisis is an effort to continue to make improvements.

Training has a real effect on improving the quality of human resources the better through training activities, when human resource development is carried out, the quality of workers is getting better, as a result of which efforts to repay services are carried out properly. The development of human resources needs to be through the right method, so that the company can have reliable employees to help the company. The methods of hr development include training or training.

FURTHER STUDY

Leadership training has now become a necessity in the development of human resources. Companies must be able to empower the competencies and skill of their employees by implementing HR development programs and employee training. The first way to improve the quality of human resources in the company is to develop soft skills owned by HR. What is meant by this soft skill is leadership, decision making, problem solving, negotiation, communication, creativity, and also expertise in presentation.

ACKNOWLEDGMENT

My thanks go out to STIE GANESHA and the Institute of Economic Development and Social Reseach (IKSAD), Turkey, UCSI Malaysia, and Rajamongol University of Technology(RUTK), Thailand and Japan for giving me the opportunity to publish this article.

REFERENCES

1. Harahap, P. 1982. Encyclopedia of education. Jakarta. Holy mountain
2. Miarso, 2007. Sowing the seeds of educational technology. Jakarta. Service Center



3. Naisbit. 2002. High touch high technology. Bandung. Mizan
4. Saliman.S. 1993. Dictionary of general education and teaching. Jakarta. Rineka Cipta
5. International Figure Reference: <http://id.wikipedia.org/wiki/Teknologi>
6. Bain, R. (1983). "Technology and State Government," American Sociological
7. Franklin, Ursula. "Real World Technology". Anansi Press House
8. Stiegler, Bernard (1998). Technique and Time, 1: Epimetheus' Error. Stanford University Press. p. 17, 82. ISBN 0-8047-3041-3
9. Mohammad Faisal Amir, Understanding Employee Performance Evaluation, Borobudur University, 2014
10. Sedarmayanti, Human Resources and Work Productivity, Mandar Maju, 2009
11. Lijan Poltak Sinambela, Employee Performance, Graha Ilmu, 2012
12. Kaswan, Management Development, Alfabeta, 2012
13. Brian Aprianto, Complete Guide to Indonesian HR Professionals, LPPM, Jakarta, 2014
14. Wibisono, Dermawan. 2011. Corporate & Organizational Performance Management: Guide for Developing Indicators, Jakarta: Erlangga.
15. Wibowo. 2007. Performance Management, Jakarta : PT Rajagrafindo Persada.
16. Sugiyono. 2005. Metode Penelitian Bisnis, Cetakan Kedelapan, Bandung : Alfabeta.
17. Suprayitno dan Sukir, 2007. Pengaruh Disiplin Kerja, Lingkungan Kerja dan Motivasi Kerja Terhadap Kinerja Pegawai DPU-LLAJ Karanganyar. Tesis
18. Sutrisno, Edy. 2009. *Manajemen Sumber Daya Manusia*. Jakarta : Kencana.
19. Tampubolon, Manahan P. 2008. *Perilaku Keorganisasi (Organization Behavior)*. Edisi Kedua. Bogor : Ghalia Indonesia.
20. The Creative Economy is the Pillar of the Future Economy. Share. <https://kominform.go.id>
21. R. Quiserto in Usaha. 9 Cara Jualan Bisnis Usaha Online di Media Sosial Sosmed Terbaik. <https://duwitmu.com/usaha/cara-jualan-bisnis-usaha-online-media-sosial-sosmed/amp/>. (Diunduh 16 Januari 2021).
22. Sari, K. Haunina. April 2020. Peluang Usaha di Tengah Pandemi Corona. <https://www.gadjian.com/blog/2020/04/23/peluang-usaha-pandemi-corona/>. (Diunduh 10 Januari 2021).



ANALYSIS OF POTENTIAL FOR CULTURAL TOURISM OBJECTS AT SITU LENGKONG PANJALU CIAMIS REGENCY IN THE POST COVID-19 ENDEMIC

Ramadani Pardian

STIE Ganesha, Economy, Jakarta, Indonesia

Abstract

This study aims to analyze the potential for cultural tourism object at Situ Lengkong Panjalu, Ciamis Regency in the Post Covid-19. This research is qualitative research. Data was collected using survey and interview methods. The management optimization cultural tourism object at Situ Lengkong Panjalu, Ciamis Regency, basically not only in terms of Regional Original Income (PAD), but also the income derived from management of cultural tourism in Situ Lengkong Panjalu. During the COVID-19 pandemic, this potential did not develop due to limited visitor activities. Then after it was stated by the WHO this covid was endemic, visitors began to get more and more crowded to visit the Lengkong Panjalu tourist attraction, Ciamis Regency. Now, increase in the potential for visitors is much higher than before, currently it has reached 50-60 buses per month that come to visit. The management in Lengkong Lake is working the management and development at Lengkong Lake, including: 1). Situ/lake lengkong; 2). Nusa Gede; 3). Nusa Pakel; 4). Nusa Gede Cemetery Complex; 5). Hujung Winangun Cemetery Complex; 6). Nyangku Traditional Ceremony; 7). Alit Earth. For the level of economic welfare of people who depend on existence at Lengkong Panjalu lake, the government has provided opportunities for the community including: 1). people who become parking attendants, they assume that the needs of their families can be met. Their income on weekdays amounts to between Rp.75,000-Rp.100,000 per day. This is very different when on certain days when Lengkong Panjalu is in high season, the parking attendant's income ranges from Rp. 200,000 - Rp. 300,000 per day; 2). People who rent boat services at a rate of Rp. 200,000 per rental for 10-20 people; 3). People who rent water bike services in various forms with a rental fee of IDR 50,000-Rp. 75,000 per rental for a maximum of 2 people; 4). The community as a tour guide where the income of tour guides is uncertain because the visitors are not set a price as a tariff for cultural tour guides. Their income ranges from Rp. 100,000-Rp150,000 per day

Keywords: Cultural Tourism, Community Welfare, Covid-19 Pandemic



**MANAGEMENT STRATEGY AS TOURISM DEVELOPMENT AT CIUNG WANARA
TOURISM OBJECT, CIAMIS WEST JAVA**

Putri Noor Ramayanti

STIE Ganesha, Economy, Jakarta, Indonesia

Abstract

Ciung Munara tourism object which tells the legend of the ancient regional kingdom has great potential in the economy of the surrounding community, the culinary field, making souvenirs and even native tour guides from the surrounding population, but this has not been optimal by the community. Qualitatively by directly visiting the Ciung Munara tourist attraction and interviewing tourists and traders around, the participant in this research are 20 persons. As for the results of the visit the authors get the results of research on how strategic management in tourism development is to improve the economy around the Ciung Munara tourist attraction. First strategy planning in tourism development needs to be supported by all partisipant starting from management of culinary entrepreneurs and souvenirs, second management strategy in attracting tourists' interest to come this tourism object and third the three culinary cultures of the resident's attraction to tourists

Keywords: Management Strategy and Turism Development

I. INTRODUCTION

A. REASEARCH BACKGROUND

In the last period during the Covid-19 Pandemic, the world of tourism had a very detrimental impact, starting from the reduced number of tourists attending, making the world tourism economic cycle decline very drastically, both local and foreign tourism. In order to improve the quality of their tourism industry, each country is trying to attract the attention of tourists again after the Covid-19 Pandemic. Various kinds of tourism activities are supported by various facilities and services provided by employers, government and local governments and the community.

In the tourism industry, a group of entrepreneurs are interrelated in order to produce goods and/or services to meet the needs of visiting tourists, ranging from culinary, attractions, tour guides. Therefore, for the sake of improving the community's economy, the tourism sector is an effective way to develop. With this, it is hoped that tourism development can develop areas that have the potential as tourist attractions. Business development mutually influences one business with other interrelated types of business such as transportation, travel business, lodging, crafts and culinary. Because this linkage is very high, so that they influence each other. Tourism is a unit of various components that can complement each other to form a product. Tourism objects give birth to manifestations so that tourists are attracted to visit to enjoy human creations, ways of life, arts and culture and national history and natural beauty.

Tourism development is an important role for the development of a region. With tourism activities in an area, areas that have basic tourism potential will be able to develop and progress more easily. In addition, regions that have basic potential for tourism tend to develop existing regional potentials so as to be able to attract large numbers of tourists. Seeing the large role and contribution of tourism, making tourism one of the mainstay sectors in improving the country's economy.



Strategic management is a plan in managing and taking into account various aspects, this aims to be able to influence the plan so that it has a positive impact on an organization in the long term. Theoretical study in strategic management is to create impact in the application of strategic concepts to companies in the long term or sustainable, including from a stable profit standpoint. Stable profits can be affected by the stability of a sales always growing.

Having knowledge of strategic management is necessary in building various plans including production, marketing, personnel, and financial plans to be used to build a sustainable business, of course by understanding the environment, especially the industrial environment correctly and well. As is the case with the Ciung Wanara object which needs to regenerate the economy in its tourist spots. For the development of Ciung Wanara tourism to grow, it requires strategic management and a fairly long planning process, because economic growth from both sectors is closely related so that it cannot be separated from the entire strategic management process.

Strategic planning is a new way to manage. Strategic Management is a series of basic decisions and actions made by top management and implemented by all levels of an organization in order to achieve the goals of the organization (Sondang P. Siagian). One form of tourism development is the development of tourism that includes local communities. Therefore, there is a need for concrete strategic management in tourism development at the Ciung Wanara tourist attraction, Ciamis, West Java. It is hoped that this can contribute significantly so that it has an impact on increasing Ciung Wanara tourists. The local government in collaboration with the community makes development in the tourism sector one of the strategies in reviving the surrounding economy.

B. PROBLEM FORMULATION

Based on the background of this research. The formulation of the problem in this study is how strategic management can improve tourism development at the Ciung Wanara Ciamis tourist attraction?

C. RESEARCH OBJECTIVES

With reference to the background and the formulation of the problem in this study, the purpose of this research is to describe management strategies in enhancing tourism development at the Ciung Wanara tourist attraction, Ciamis.

II. BIBLIOGRAPHY

A. MANAGEMENT STRATEGY

Strategy comes from the word Strategos in Greek, which is a combination of Stratos or army and Ego or leader. A strategy must have a basis or scheme for achieving the objectives. So that later the strategy becomes a tool to achieve goals in relation to long-term goals, if there are programs that do not continue, as well as priorities in allocating resources. Strategy can also be said to be a pattern for goals, policies, actions, decisions or allocating resources that define how the organization runs, what it does, and why it does it.

According to Bambang Haryadi, "The notion of strategic management is a process that is systematically arranged by management to formulate strategies, implement strategies, and evaluate the strategies being implemented. All of these series of activities aim to realize the vision and mission of an organization."

Nawawi argues, "Strategic Management is a large-scale planning that is oriented to reach the distant future, and is defined as a fundamental and principal decision of the highest leader." Planning can be



said that organizations that interact effectively, in order to produce something of quality, optimize the achievement of strategic goals and are right on target.

According to Mulyadi, "strategic management is a process carried out by managers and employees to formulate and implement strategies to provide the best customer value to realize the organization's vision".

Strategic management is a series of actions and decisions to determine the performance of a company to be managed in the long term. A strategy whose planning has been prepared thoroughly and has the advantage of realizing what is faced in the environment and is designed to ensure that the company's main objectives can be achieved through proper implementation by the company. From the definitions above, it can be concluded that strategy is a structure that has been planned or steps presented in an organization that is managed by its management so that it can change in a better direction in order to realize organizational goals.

B. TOURISM DEVELOPMENT

According to Wahab Tourism is an important factor to foster national unity whose people have different regions, dialects, customs and diverse tastes. Tourism is an important goal in economic development, because in its activities it leads to the development of several sectors of the national economy such as increasing urbanization, renewing facilities at tourist attractions, infrastructure and tourism infrastructure. In addition, other economic growth related to other tourism services: transportation, accommodation, handicrafts. Where all require a long cycle to reach and expand the market for local goods. This can support state income with foreign currency so that it can advance the national economy.

Tourism development is an effort to develop or advance tourist objects so that these attractions are better and more attractive in terms of places and objects in them to be able to attract tourists to visit them. According to Barreto and Giantari (2015:34).

The development of tourist areas is an alternative that is expected to be able to encourage both economic potential and conservation efforts. The development of tourism areas is carried out by rearranging various natural and biological potentials and assets in an integrated manner. In the next stage, a tourism area management model that is oriented towards environmental preservation is developed (Ramly, 2007).

According to Mariotti, tourism potential is everything that is found in tourist destinations, and is an attraction so that people want to come to visit these places.

Basically, tourism development is a continuous process of continuous matching and adjustment between the supply and demand sides of available tourism to achieve a predetermined mission (Nuryanti, 1994). While the development of tourism potential has efforts to increase the resources owned by a tourist attraction by developing a tourism system so as to increase its productivity.

For regions that are currently developing and building their tourism industry, it is necessary to pay attention to the calculation basis for planning, so that tourism development can provide maximum results for regional development.

III. METHODOLOGY

In this study using a qualitative approach. Where this research will analyze how to plan in strategic management to help develop the Ciung Wanara tourist attraction, Ciamis, West Java.

To obtain the data in this study, primary data was used, the source of which was obtained directly by the respondents by visiting the Ciung Wanara tourist spot and then interviewing arriving tourists and traders at the tourist attraction. The secondary data obtained in this study comes from a collection of



documents that have been published by the Ciung Wanara tourist attraction as well as written notes related to this research both from static and dynamic data regarding strategic management as tourism development at the Ciung Wanara Tourism Object, Ciamis, Java West.

Data collection techniques used in this study were observation, interviews and month documentation. Data analysis is obtained through data reduction, data presentation and decision making.

IV. RESULT OF RESEARCH

After going through the process of observing and interviewing tourists visiting Ciung Wanara tourist attractions, Ciamis and interviewing local traders with reference to the background of the problem and the formulation of the problem in this study, the researchers obtained the results of research on strategic management as tourist development at the Ciung Wanara tourist attraction, Ciamis, West Java as follows:

1. Strategic planning in tourism development needs to be supported by all parties, starting from the management of culinary and souvenir entrepreneurs.

Judging from the large number of tourists who attended before the Covid-19 pandemic compared to post-Covid-19, this dropped very significantly, this caused income at the Ciung Wanara tourist attraction to decrease. Not only that, the decline in the number of visiting tourists also has an impact on local traders because their livelihood is only in these tourist spots.

Even though there are more tourists visiting on weekends compared to weekdays, traders selling culinary and souvenirs feel that their daily income is the same. This is because even though on weekdays there are not as many tourists visiting on holidays but with the presence of tourism and inter-provincial buses resting at this Ciung Wisata tourist spot. Therefore, before the policy, during the covid pandemic, residents were prohibited from traveling, there were fewer tourists and buses that stopped by at Ciung Wanara. Thus, the head of management of the Ciung Wanara Tourism Site together with the Chairperson of the Ciung Wanara Traders Association held a deliberation in developing this tourist spot starting from culinary, currently there are traders selling food typical of this tourist spot, namely "Pepes Ikan Nilem", online or sent to restaurant outside the Ciung Wanara tourist attraction. Not only Pepes fish, for the sake of continuing his trading business, every day each sword who has expertise in making snacks makes innovations so that his products can be packaged and can be sold outside the tourist attraction. Apart from the culinary field, souvenir craftsmen have also started their fortune by selling their work online. However, sales through online and Cash on Delivery for this area have not yielded maximum results.

2. Management strategy in attracting tourists to come to Ciung Wanara tourism objects

In addition to traders who have to innovate, the management has started to improve so that many tourists visit the Ciung Wanara Tourism area, the strategy undertaken includes working with Event Organizers from within or outside the city who want to hold events at this tourist spot. Even though the need for marketing management itself must market the existing facilities at this Ciung Wanara tourist spot. Usually, Event Organizers contact directly with the management of tourist attractions.

With the events being held by outside parties, many tourists invited to the event visited this Ciung Wanara tourist spot. Therefore, the management and traders need to provide good service so that tourists who attend certain events will visit again at another time.

3. Distinctive cuisine is the main attraction for residents to tourists.

In this Ciamis area, there are many who raise tilapia, therefore Pepes Ikan Nilem, where pepes tilapia still has fish eggs in it, is a special food, especially in Ciung Wanara tourist attractions. Likewise, the traders plan to process their snacks so that the processed food can last longer, so that visitors from outside can bring these Ciung Wanara specialties home.



This is because some respondents from outside the area, especially the bus they were traveling on, only briefly rested at this tourist spot, wanting to bring home Ciung Wanara's special food and not just eating on the spot.

Management in this way is not only beneficial for traders even though their merchandise is out of tourist attractions, of course traders will carry the name "Khas Ciung Wanara" so that people out there can visit this tour later.

V. CONCLUSION

From the discussion above, the researcher draws conclusions from the results of this study, including: If the management strategy is carried out correctly, the development of tourists visiting this tourist spot will be faster, but the need for strategies carried out directly by all parties involved in the Ciung tourist attraction Wanara starts from important innovations provided by traders, craftsmen and managers.

In addition, there is a need for marketing management in managing this Ciung Wanara Wista Object. Because, indeed this place is a cultural heritage site and is cared for by the local government, however, for the sake of tourism development so that the economic turnover improves, it is not only event organizers who can contact the management, it would be better if the tourism object manager gives special offers regarding existing facilities so that many event organizers want to hold a big event at Ciung Wanara.

Finally, in terms of making Pepes Nilem's special food, when it is processed so that it lasts longer and is brought home by tourists as souvenirs, a special processing process is needed so that the food does not spoil easily and the taste is maintained. Not only pepes, nilem fish, like snacks, also need proper processing so that they can be marketed outside.

Those are some of the conclusions drawn by researchers so that it is hoped that managers, traders and craftsmen in Ciung Wanara, Ciamis can process their management with good strategies to achieve common goals, namely that the development of tourists in Ciung Wanara continues to increase.



VI. BIBLIOGRAPHY

- David, Fred R. 2012. *Strategic Management*. Jakarta : Salemba Empat.
- Desi. Monica. Moevtia. Azarya. 2021. *Strategi Pembangunan Wisata*. Sleman: Graha Ilmu
- Harmini, Anak Agung Ayu Ngurah. Pemayun, I. Dewa Gede Ari, Sukmawati, Ni Made Rai. 2021. *Buku Ajar Pariwisata Alternatif*. Eurika Media Aksara
- Hermawan, Sigit Dan Sriyono. 2020. *Buku Ajar, Manajemen Strategi, Resiko*. Sidoarjo : Umsida Press'**
- Sedarmayanti. Sastrayuda, Gumelar S dan Afriza Lia. 2018. *Pembangunan dan Pengembangan Pariwisata*. Bandung : Refika Aditama
- Subyantoro, Arief. 2020. *Manajemen Sumber Daya Manusia Strategi*. Yogyakarta: Penerbit Andi.**
- Sulistiyadi, Yohanes. Eddyono, Fauziah. Derinta, Entas. 2019. *Indikator Perencanaan Pengembangan Pariwisata Berkelanjutan*. Jakarta: CV. Anugrah Utama Raharja
- Yunus, Eddy. 2016. *Manajemen Strategis Edisi 1*. Yogyakarta: Penerbit Andi.**
- Zebua, Manahati. 2020. *Inspirasi Pembangunan Daerah*. Yogyakarta: Deepublish



SOCIAL ENTREPRENEURSHIP OF LECTURERS IN IMPLEMENTING COMMUNITY SERVICE AS THE IMPLEMENTATION OF THE TRI DHARMA OF HIGHER EDUCATION

Patria Adiguna

STIE Ganesha, Economy, Jakarta, Indonesia

Abstract

Entrepreneurship is one of the important elements in improving one's welfare, especially lecturers who deal with students who come every day asking for guidance in trying. Entrepreneurship shows a portrait of creativity and innovation for a lecturer in producing social service activities or community service. How the social entrepreneurial spirit possessed by lecturers in community service programs is the focus that this research wants to reveal.

The research method used in this study is a qualitative research method with a case study and survey approach. Informants consist of senior lecturers and new lecturers as well as several leaders from the world of education. Data collection uses participatory observation techniques and in-depth interviews with informants.

The results of the study found that there were still many lecturers who were not aware of their obligations for community service as mandated by Indonesian law. The research findings also show that there are still many lecturers who think that community service is a very burdensome thing for lecturers. Many lecturers try to avoid community service programs. With regard to entrepreneurship, many lecturers do not have skills in entrepreneurship and think that lecturers do not need to have them. This raises the question of how lecturers can educate their students to become entrepreneurs if they do not have the entrepreneurial competence at all?

Keywords: lecturer, entrepreneurship, lecturer competence, community service, social

I. INTRODUCTION

One of the important implications in relation to the constellation of global competition and the issue of national higher education policies is the need for the development of entrepreneurship-oriented universities and university graduates who are competent in entrepreneurship. The urgency of developing higher education oriented to the formation of entrepreneurial attitudes for graduates,

Viewed from the point of view of education management, the problems of entrepreneurship education in the two universities can be identified as follows: (1) the entrepreneurial vision has not been used as a basic value and reference for the actions of all parties in preparing university graduates. This further creates confusion for students to practice entrepreneurship or be entrepreneurial after they finish their studies; (2) entrepreneurship teaching tends to be more oriented towards theoretical philosophical understanding so that it does not provide a learning experience that is oriented towards developing attitudes and skills; (3) entrepreneurship education has not been organized and accommodated integratively in the implementation of the tridharma of higher education so that it is not optimal in achieving student entrepreneurial attitude competencies.



This literature review is a review of a number of relevant previous studies as well as a comparison of this research. Robinson's research (1994) "The Effect of Education and Experience on Self-employment Success", found that education has a strong positive influence on entrepreneurship, in realizing the ability to work independently and graduate success. Experience also has the same nature of relationship although it is not as strong as education. Galus (2009) "The Relevance of Entrepreneurship Education in Higher Education" concluded that the disinterest in entrepreneurship of the scholars participating in the SP3 and TKPMP programs was caused by three factors: (1) mindset problems. Many scholars still think of themselves as job seekers, not job creators; (2) the problem of the entrepreneurship curriculum that has not been adequate in quantity and quality; (3) lack of seriousness in creating entrepreneurs from among students.

Another study submitted by Susilaningsih (2012) "Construction of Entrepreneurship Education Program Models in Higher Education: Sequential Exploratory Mixed Research Design Approaches Based on Multicases" shows that the factors that surround the success of entrepreneurship education programs in universities in Indonesia are university commitment; entrepreneurial climate; main activities; support activities (continued); and infrastructure. By fulfilling these factors, the proposed model construction of entrepreneurship education program is: implementing the program in stages starting with the stage of triggering entrepreneurship awareness; basic stage; the stage of awareness of the need for competence; application stage of creativity and innovation; start-up stage; and growth stage. Chibuzor and Friday (2013) "Adopting Strategic Management in Planning and Implementation of Entrepreneurship Education in Tertiary Institutions in Nigeria" emphasize that entrepreneurship education programs not only provide theoretical knowledge, but also ensure the development of an entrepreneurial mindset in graduates, through the formation of entrepreneurial skills, behaviors and attitudes, which are the key competencies and enable them to become entrepreneurs.

The existence of universities is given a theoretical explanation by Perkin (2006:168)'s view of the three main missions of higher education, which refers to aspects of acquisition, transmission, and application. In addition, with the functions and dimensions of higher education, Indrajit and Djokopranoto (2006:36) discuss five dimensions inherent in the meaning of higher education, namely: (a) the scientific dimension; (b) the education dimension; (c) social dimension; (d) corporate dimension; and (e) the ethical dimension. As for universities that want to realize the vision of entrepreneurship, it is very important to condition themselves as learning organizations, namely learning organizations meaning as organizations that are experts in creating, acquiring and transferring new knowledge and views, as well as experts in changing behavior to reflect these new knowledge and views (Garvin, 1993:78).

The concept of educational management is first explained by three aspects of the understanding of management from Fattah (2000: 19), namely: management as a science, as a process, and as an art. Furthermore, it is defined based on the view of Engkoswara (2001:24) that education management is a science that studies the arrangement of resources to achieve the goals that have been set productively, and the creation of a good atmosphere for humans who participate in achieving that goal.

Entrepreneurship education is seen broadly, covering the terminology of skills that can be taught and characteristics that can arouse student motivation so that they can help them to develop new plans and innovative plans for a new business venture (Brown and Galloway, 2002: 398). The theoretical explanation of aspects of entrepreneurship education also refers to research on "Role of higher education in promoting entrepreneurship education across disciplines in Tanzania" (Klasi, 2011:59) identified several models of entrepreneurship education, namely the traditional business model;



integrated model for entrepreneurial performance; intentional models; and societal models of entrepreneurship.

II. RESEARCH METHODS

This study uses the research approach of Borg and Gall (2003: 570), that "educational research and development is a process used to develop and validate educational products" which consists of: (1) Preliminary study consisting of literature study, initial observation (description of current entrepreneurial education management, analysis of current entrepreneurial education management models); (2) Model development: integrated entrepreneurship education management and implementation guidelines, FGD validation with a team of experts and stakeholders, evaluation and revision; (3) Model validation: final model of integrated entrepreneurship education management and implementation guide, limited trial, final model of integrated entrepreneurship education management.

Data collection techniques consist of (1) Observation regarding the process and results; (2) Interviews to reveal: (a) information from the Dean, Head of Study Program, and Entrepreneurship Lecturer, regarding policies, implementation strategies, inputs, processes, and outputs of entrepreneurship education management in PTS under study; (b) Students' perceptions, experiences, and feelings about entrepreneurship education at their universities; (3) A closed questionnaire to obtain data on the perceptions, assessments, and experiences of students on the aspects of the process and benefits of entrepreneurship education that they have experienced, through higher education tridharma programs and activities.

III. RESULTS AND DISCUSSION

A. Conditions of Entrepreneurship Education Management

The management of entrepreneurship education in the Economic Education Study Program at the two private universities studied includes the functions of planning, organizing, staff development, direction, and supervision. Study program level planning is realized during the preparation of the annual Work Plan and Budget (RKA), semester RKA, Monitoring and Evaluation RKA, and follow-up actions. The annual RKA of the study program is proposed to the faculty to be followed up at the university level to become the Study Program Work Program. Organizing at the study program level is carried out based on the mechanism, organizational structure hierarchy, and main tasks as stated in the University Academic Guidelines.

The development and improvement of the career path of lecturers and education staff is carried out based on their abilities and competencies. The direction of the study program management policy is carried out by the Head of the Study Program to all lecturers and students. Briefing is carried out at the beginning of each semester to all lecturers to evaluate lectures during the last semester. Supervision by the Head of Study Program is carried out regularly, either directly or indirectly, aiming to ensure the accountability of the management system.

B. Empirical Model of Entrepreneurship Education Management

The empirical condition of entrepreneurship education management in the Economics Education study program at two private universities is characterized by the lack of alignment of the entrepreneurial vision with its implementation, and the unintegrated entrepreneurship education in the tridharma activities of higher education.



1. Unharmonious Entrepreneurial Vision

The author's review of the planning document found that entrepreneurship is indicated in the formulation of the vision of the university, faculty, and study program. This is the congruence meant by the respondents. Thus, at the policy and management level, the realization of this vision still has to be harmonized between universities and faculties and study programs.

In relation to the leadership commitment, 20 people (40.82%) of the academic community respondents in the two study study programs perceived that the leadership's commitment to implementing entrepreneurship education was strong. Then, 15 people (30.61%) of respondents stated that it was very strong; and 14 people (28.57%) respondents considered it weak. In general, the data informs the importance of the similarity and strength of commitment between leadership levels (universities, faculties, and study programs) in the policy and management of entrepreneurship education implementation.

2. Entrepreneurship Education is not yet integrated

The two study programs studied have implemented entrepreneurship education in the form of learning entrepreneurship courses and supporting courses, entrepreneurship research, and community service about entrepreneurship. Entrepreneurship education activities can be categorized as follows: learning entrepreneurship courses, student activities with entrepreneurship content, entrepreneurship research in the context of preparing student thesis, entrepreneurship research by lecturers, entrepreneurship advocacy by lecturers in the context of community service, and student scientific meetings.

However, the degree of integration and functional linkages between these categories of activities still needs to be strengthened. So far, each of these activities is mutually exclusive from one another. This condition does not support the principles of research and researchbased service in universities.

Weak integration and functional linkages between categories of entrepreneurship education activities have also resulted in the outcome of these activities being utilized more for individual personal needs, and not for improving the quality of the higher education tridharma process or increasing the contribution of higher education tridharma for wider interests.

The integrated entrepreneurship education management model developed in this study is an alternative model that has fundamental differences compared to the empirical model design as described and analyzed above. The differentiating element lies in the integration between learning, research, and community service with an entrepreneurial content.

This integrated entrepreneurship education management model first requires that the study program has a commitment to cultivating entrepreneurship. This commitment is reflected in the desire to condition the institution (focus on the vision of the study program) and prepare graduates who have an entrepreneurial mentality in addition to other competencies that must be possessed by graduates.

In addition to the vision, the conceptual model should have two dimensions, namely the dimension of entrepreneurship education resource management and the management dimension of entrepreneurship education programs. Entrepreneurship education resources as a support for the formation of student entrepreneurial attitudes include lecturers, curriculum, learning resources, and learning facilities, which as a whole must be managed efficiently and effective so as to ensure the productivity of entrepreneurship education. These entrepreneurial education resource management functions are carried out to condition the lecturers, curriculum, learning resources, and learning facilities as identified in the following table.



The supervisors and the participants of this study also suggested that the management dimension of the entrepreneurship education program should be carried out through synergy and integration of the implementation of higher education tridharma activities, which include teaching, research, and community service. Management is directed at achieving the conditions for each of these fields that ensure the effectiveness of entrepreneurship education.

The entrepreneurship education management model developed in this study is an alternative model that has fundamental differences compared to the above empirical model. The differentiating element lies in the integration between learning, research, and community service with an entrepreneurial content. This integrated entrepreneurship education management model first requires that the study program has a commitment to cultivating entrepreneurship. This commitment is reflected in the desire to condition the institution (focus on the vision of the study program) and prepare graduates who are entrepreneurial in addition to other competencies that must be possessed by graduates.

In addition to the vision, this model has two dimensions, namely the dimension of entrepreneurship education resource management and the management dimension of entrepreneurship education programs. Entrepreneurship education resources as a support for the formation of student entrepreneurial attitudes include lecturers, curriculum, learning resources, and learning facilities, which as a whole must be managed efficiently and effectively so as to ensure the productivity of entrepreneurship education.

C. Discussion

Judging from the functions and fields of work, the management of entrepreneurship education at the two private universities, especially at the study program level, proceeds as an inseparable part of academic and non-academic management of study programs. These functions include planning, organizing, staff development, direction, and supervision.

The empirical condition of entrepreneurship education management at the two private universities is characterized mainly by the lack of alignment of the entrepreneurial vision and the unintegrated implementation of entrepreneurship education. However, the degree of integration and functional linkages between these categories of activities still needs to be strengthened. This condition is in line with the map of entrepreneurship education management problems in universities covering the following aspects.

First, the qualifications and competencies of graduates who are prepared through the higher education process are not always related and commensurate with the competencies and qualifications demanded by the users of education graduates. Second, that the ideas, concepts, or visions of university graduates who are entrepreneurial can create new problems if their implementation is not based on the right understanding and workings of the system. Third, entrepreneurial attitude as one element of the competence of college graduates, is not a condition or outcome measure that stands alone regardless of the process. It is the quality of output or educational outcomes that will depend on the quality of the educational process.

The integrated entrepreneurship education management model is carried out through classroom learning, research, and community service which are overall designed according to the ability of the study program. This is based on the Higher Education Law Number 12 of 2012, Article 1 which explains that: The Tridharma of Higher Education is the obligation of Higher Education to provide education, research, and community service (paragraph 9). Ideally, the three dharmas of the university run in unison and synergize. Colleges should not only fulfill some dharmas and deny others. Therefore, balancing the portion of the implementation of the three dharmas is very important.



The main element in this model is the commitment of universities in cultivating entrepreneurship which is formulated in the vision of the study program, among others. This vision is important because it is an explanation of what an organization should look like if it runs well. Another important element of this final model is the entrepreneurial attitude of students. Thus, entrepreneurship is thought and action about how someone can take advantage of opportunities and take risks by innovating without relying on existing resources to achieve goals, even though what is done is difficult and full of risks. Always ready to look for alternatives in overcoming challenges, obstacles, and work problems.

Instructions for implementing the integrated entrepreneurship education management model are compiled in the form of a guide book. The feasibility of the guidebook covers the following aspects: (1) book systematics; (2) the substance of the book; (3) explanation; and (4) graphics. The feasibility of the guidebook was assessed based on the opinions and assessment options provided by experts and practitioners of management, education and entrepreneurship through FGDs. Based on the testing procedure, it was found that the FGD participants' assessment of all indicators of the book systematics; book substance; language; and the graphics show the feasibility of the manual.

The feasibility of the model from the program aspect is related to the convenience of lecturers to meet the quality of the elements in the entrepreneurial learning process. The data informs that the aspects of entrepreneurship learning management carried out by the collaborating lecturers of this research are generally categorized as good. The aspects referred to are objectives, lecture materials, methods, evaluations, and assessment components. That is, the final model can be said to be effective in terms of achieving the quality elements of the learning process that can be carried out by lecturers.

The feasibility of this final model is also measured by the predictive views of students in the two study programs studied about the learning satisfaction they might get if the model is applied, especially in entrepreneurship learning activities in their classrooms. The data shows that after the student respondents reviewed the guidebook for implementing the integrated entrepreneurship education management model, especially the management of learning activities, they predicted the goodness of the eight learning indicators. In other words, if the integrated entrepreneurship education management model is applied, then from the aspect of student learning satisfaction it is predicted to be better than the empirical model that has been taking place in the two study programs studied.

The feasibility of the final model seen from the aspect of the study program can also be seen from the assessment and approval or perception of the Head of the Study Program, lecturers in charge of entrepreneurship courses, and lecturers supporting entrepreneurship cognate courses in the two study programs studied against the management framework of the integrated entrepreneurship education program. Respondents' approval index and category explained that the overall substantive aspects of integrating tridharma activities as an important part of the final integrated entrepreneurship education management model were approved and considered good by the respondents.

IV. CONCLUSION

Based on the results of research and development of entrepreneurship education management model as described above, the following conclusions can be drawn.

1. The management of entrepreneurship education under study includes the functions of planning, organizing, staff development, direction, and supervision.



2. The empirical condition of entrepreneurship education management is characterized by the lack of alignment of the entrepreneurial vision with its implementation, and the unintegrated entrepreneurship education in the activities of the tridharma of higher education.
3. The entrepreneurship education management model developed in this study is an alternative model that has fundamental differences compared to the above empirical model. The differentiating element lies in the integration between learning, research, and community service with an entrepreneurial content.

REFERENCE

- Borg, W & Gall. 2003. Educational research: an introduction. New York and London: Longman.
- Brown, W dan L. Galloway, 2002, "Entrepreneurship Education in University: A Drive in the Creation of High Growth Firms?", Education + Training, Vol. 44 Iss: 8/9, pp.398 – 405
- Chibuzor, Gbandi Eleazar dan Eboime Ohimai Friday, 2013. "Adopting Strategic Management in Planning and Implementation of Entrepreneurship Education in Tertiary Institutions in Nigeria", European Scientific Journal (ESJ) Vol 9 No 31 (2013), tersedia [online] <http://eujournal.org/index.php/esj/article/view/2072>
- Engkoswara. 2001. Paradigma Manajemen Pendidikan Menyongsong Otonomi Daerah, Eidisi ke-2.
- Bandung: Yayasan Amal Keluarga.
- Fattah, Nanang. 2000. Landasan Manajemen Pendidikan. Bandung: Remaja Rosdakarya.
- Galus, Ben Senang, 2009. Relevansi Pendidikan Kewirausahaan di Perguruan Tinggi. Tersedia [online] http://www.pendidikandiy.go.id/dinas_v4/index.php?view=v_artikel&id=17
- Garvin, David A. 1993. "Building a Learning Organization." Harvard Business Review 71, no. 4 (July– August 1993): 78–91.
- Indrajit, R.Eko., & Djokopranoto, R. 2006. Manajemen Perguruan Tinggi Modern. Yogyakarta: Andi Offset.
- Kilasi, Perpetua K. 2011. "Role of higher education in promoting entrepreneurship education across disciplines in Tanzania". ICSB World Conference Proceedings; Washington: 1-22. Washington: International Council for Small business (ICSB). (2011) tersedia [online], <http://search.proquest.com/openview/55add597deeadbbac9cb23209c2483ae/1?pq-origsite=gscholar>
- Perkin, Harold (2006) "History of universities". In: Forest, James and Altbach, P. (eds) International Handbook of Higher Education. Dordrecht, Netherlands: Springer.
- Robinson, Peter B. and Edwin A. Sexton. 1994. The effect of education and experience on self-employment success. Journal of Business Venturing, 1994, vol. 9, issue 2, pages 141-156, tersedia [online] [http://www.sciencedirect.com/science/article/pii/0883-9026\(94\)90006-X](http://www.sciencedirect.com/science/article/pii/0883-9026(94)90006-X).
- Susilaningsih, 2012. "Konstruksi Model Program Pendidikan Kewirausahaan di Perguruan Tinggi: Pendekatan Sequential Exploratory Mixed Research Design Berbasis Multikasus", Disertasi, Universitas Negeri Malang.



**EFFECTIVENESS OF USING DRILL METHOD ON IMPROVING MATHEMATICS
LEARNING OUTCOMES IN CLASS X STUDENTS OF SMA NEGERI 99 JAKARTA**

Nurhayati

Adi Permana

STIE Ganesha, Economy, Jakarta, Indonesia

Indraprasta PGRI University, Economy, Jakarta, Indonesia

Abstract

This study aims to determine the effectiveness of the use of the drill method on improving mathematics learning outcomes in grade X students of SMAN 99 Jakarta. The method used in this study is an experimental method with an average difference test analysis. Data collection is carried out by compiling research instruments. An instrument is a special test given to a sample in the form of a test instrument for mathematics learning outcomes. The population was 321 students with a sample of 40 students. The results of the data analysis showed that there was a significant influence on the use of the drill method on improving mathematics learning outcomes in Grade X Students of SMAN 99 Jakarta. It is based on the t-test for Equality of Means 2-way significance value (t-tailed) $0.00 < 0.05$ So there is a difference in the real significance of the point score which is meaningful between the Experimental and control groups. The average difference between the groups was 9.8 points where the average experimental group was 79.45 and the control group 69,65.

Keywords: Drill Method, Mathematics Learning Outcomes, Effectiveness



PRODUCT DIVERSIFICATION IN TRADITIONAL FOOD” KOLONTONG” IN CENTRA OPAK, TASIKMALAYA IN MSME RECOVERY EFFORT IN THE POST COVID-19 PANDEMIC

Nita Fauziah Oktaviani

Evilia Sri Yuniar

Perjuangan Tasikmalaya University, Economy, Tasikmalaya, Indoneisa

Abstract

The Covid-19 pandemic that hit every country made several economic sectors weaken, including in Indonesia. Several economic sectors such as MSMEs were also affected due to the economic slowdown that occurred. But now the pandemic phenomenon has begun to decline and the curve of economic improvement has begun to occur. The MSME sector is now starting to rise slowly to recover its situation. One of these sectors is the Traditional Food Center in Tasikmalaya City, which is located in Cikatuncar Village, Tasikmalaya City. But the fact is, even though MSMEs in this area are included in the scope of traditional food centers, innovation in terms of product types and packaging is to time and minimal packaging. This is quite unfortunate considering the potential it has. So, through this community service, we take an approach by innovating products and packaging for Small and Medium Enterprises (SMEs) Kolontong at the Traditional Food Centre in Tasikmalaya. The product innovations carried out are expected to modernize the traditional food products of the City of Tasikmalaya and also increase product competitiveness in the midst of the competition in the post-pandemic era. The result of this service is the kolontong innovative products in terms of brands, packaging and product types. And the new product received a positive response from consumers so that our MSME partner will continue to innovate this product independently.

Keywords: Traditional Food, Product Innovation, Product Diversification

PRELIMINARY

The Covid-19 pandemic that has hit the world has slowed several economic sectors, including in Indonesia, people's purchasing power has decreased moreover the uncertainty of the future, making the pandemic period seem like a long tunnel that must be traversed with caution in the midst of confusion but full of hope. People at the time use money more carefully so, made the economic slowing down and made several sectors weaken, one of which was the Food Sectors. The results of the BPS survey, the growth of the Food and Beverage industry has experienced strong growth the lowest in the second quarter of 2020 where it was recorded at 0.22% (year on year) when compared with the previous quarter of 3.94%. Although the food and beverage industry sector experienced growth but this is much lower when compared to the previous year when cases Covid-19 has not been confirmed. One of these sector is traditional food sector.

Competition in the culinary world is quite tight, especially traditional food must also compete with other modern foods. moreover with the development of the times and technology that can make people's tastes change, this is another challenge for traditional food to survive. If traditional foods do not keep up with the times, technology and market tastes, it will be difficult for them to survive in today's competitive food world.



Moreover, the Covid-19 pandemic that hit several economic sectors in Indonesia also made Traditional Food MSMEs have to think creatively in order to survive in the midst of the onslaught of the economic slowdown. So there needs to be real action in helping the Traditional Food SMEs. Because traditional food is something that should continue to be preserved, because traditional food is the nation's ancestral heritage and can even be a characteristic of a region.

Therefore, the community service that will be carried out is by helping MSMEs, especially in the Tasikmalaya Traditional Food Center, in Cikatuncar Village area which mostly produces products traditional foods such as: Kolontong, Opak and Ranginang. And then, the service team will innovate on one of the traditional food products, namely ; Kolontong. There is another community services titled “Culinary Product Packaging Training Persuasive For Cooperatives And District SMSEs Bandung”. This community service was similar with ours, that they claimed that their community services was bring the benefit of the importance of packaging in influence buyers in choosing and buying a product in addition to maintain product hygiene One way that can be done is to increase their competitiveness through product innovation. The other community services titled “Packaging Improvements as an Effort to Increase the Competitiveness of Pure Snack SME Products”, they claimed that their community services have improved the condition of SMEs, increased SME knowledge, and improved the marketing.

In this area, although they are traditional food centers, in terms of shape, taste, and packaging, they are very minimalist and tend to be conventional. Even though the environment is a centre, which should be the centre of creativity for the Traditional Food SMEs. Therefore, the community service team took the service title "Product Diversification in "Kolontong" Traditional Foods at Sentra Opak, Tasikmalaya in an Effort to Restore MSMEs in the Post-Covid-19 Pandemic Period". Through this service, it is hoped that MSMEs can apply product innovation and develop creativity so that traditional food can survive by modernizing it without losing its identity as traditional food.

MATERIAL AND METHODS

Some of the stages carried out in this community service are as follows:

1. Ask for permission from village officials and hold discussions with village officials and some local citizens to ask for recommendations for Kolontong SMEs that can be collaborate to work together to innovate kolontong products. After getting the recommendation, we go to the MSME and also discussed until an agreement was finally found and we finally entered into a cooperation contract according to the procedures set by the University.
2. Redesign the old brand with a new design that more modern and colorful, so consumers are more interested in buying the product.
3. Make changes to the packaging. Old packaging tends to only use plastic tied with a rope and or stapler. However, to adapt to the new brand design, ziplock plastic packaging and plastic sealer are used.
4. The process of making kolontong with new shapes and flavors. Because there is a new variant, namely chocolate flavor, several experiments were carried out first until it was felt that the product was worthy enough to be sold.
5. Packaging Process with new Brand Packaging and Design.

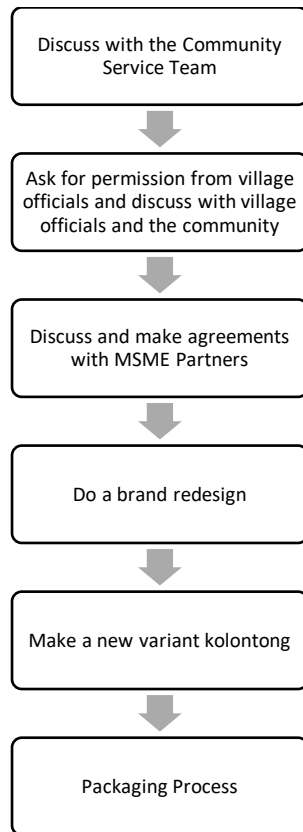

Picture 1. Community Service Method

RESULTS AND DISCUSSION

The stages of community service implementation carried out are as follows:

1. Stages of discussion with the community service team regarding the strategy and what stages will be carried out.
2. The stages of asking for permission from the local village apparatus have been carried out. Discussions were held with village officials and several citizens to ask for recommendations on which MSMEs could cooperate.
3. The stages of visiting partner MSMEs and discussing the purpose of doing this community service, and then made an agreement according to the procedures required by LP2M UNPER. At this stage, it has been determined that the MSME partner in this community service activity is the "ASTRI" MSME which produces traditional foods such as Opak, Kolontong, Rangenang, etc.
4. Brand redesign stage



Picture 2. Redesign Packaging Brand

5. Implementation Stage of Making Kolontong

The majority of Kolontong products in Cikatuncar Village have a brown sugar taste and are oval in shape. In this service service, we innovated the kolontong in terms of taste and shape. For flavor variants, we innovated into chocolate flavors with colorful sprinkles. And for the shape, we make kolontong with a small square shape. The process of making kolontong were followed:

- 1) Made kolontong dough and then dry half dry
- 2) Cut the kolontong according to the desired size, because we wanted a small box shape, so we cut it into that size according to the direction of Mrs. Eti (Owner of ASTRI UMKM).
- 3) Re-dry the pieces to dry.



Picture 3. The Process of Cutting Half-Finished Cobs



- 1) Give the kolontong taste with melted chocolate and also with brown sugar.



Picture 4. Drying Half-Finished Kolontong



Picture 5. Oven Process



Picture 6. The Process Of Coating The Kolontong With Chocolate

6. Packaging Stages. Kolontong that has been given a taste, then packaged in a new package that has been prepared. In this service, we diversify packaging based on product weight, because in the previous, the MSME often sell it in 500gr or 1kg. So in this service, the packaging consists of a weight of 100 gr, 200gr, and 250gr.



Picture 7. The Packaging Process For Kolontong Products

After the packaging process, the product could be directly sold with price adjustments that have been made in accordance with the cost calculation and also an agreement with the MSME owner. Products are sold by consumers of ASTRI SMEs because they already have their own consumers who usually come to buy the products at their homes. In addition, the service team also sells to the UNPER campus.

The results of the transformation of our kolontong product innovation are as follows:



on



7. Results Evaluation. From the observations, kolontong innovation products received very positive responses. So that the products have been sold out in a fairly short time. In addition the MSME partner get some additional requests to produce similar products. So that MSME partner will continue to innovate this product to meet consumer demands.



Picture 9. Grup Photo

CONCLUSIONS AND SUGGESTIONS

The innovations we have succeeded in this community service are:

1. In terms of brand design. We created a new brand design that more eye catching and displays the phrase "Oleh-Oleh Tasikmalaya" or "Traditional Food from Tasikmalaya", to emphasize that kolontong product is traditional product that must be proud of and that phrase can added the traditional value and become the thing that must be purchased when visiting Tasikmalaya, thus attracting potential consumers to buy.
2. In terms of packaging, making packaging more attractive and safer for kolontong products that are easy to soggy and bring some ants. And there are ziplock packaging and also plastic sealer packaging to increase product weight variation.
3. In terms of taste. Kolontong was made with chocolate and sparkle flavors in a small rectangle shape, as well as the original taste, brown sugar.
4. We tested those innovated products by sold it at home of the MSME owner, and as a result, the products from this service was sold out and there were several more requests from consumers for those products. So the product innovations that carried out in this community service run well and successful.

BIBLIOGRAPHY

Ekonomi Indonesia Triwulan III 2020 Tumbuh 5,05 Persen (q-to-q). (n.d.). Retrieved from [www.bps.go.id: https://www.bps.go.id/pressrelease/2020/11/05/1738/ekonomi-indonesia-triwulan-iii-2020-tumbuh-5-05-persen--q-to-q-.html](https://www.bps.go.id/pressrelease/2020/11/05/1738/ekonomi-indonesia-triwulan-iii-2020-tumbuh-5-05-persen--q-to-q-.html). Date accessed : October 20 2022

Kusnandar et al. (2021). Packaging Improvements as an Effort to Increase the Competitiveness of Pure Snack SME Products: Journal of Community Service Vol. 4, No. 2. ISSN 2620-844X. Available at : <<https://jurnal.unpad.ac.id/kumawula/article/view/34958>>. Date accessed : October 17 2022



INTERNATIONAL ASIAN CONGRESS ON CONTEMPORARY SCIENCES – VII

Wirania et al. (2019). Persuasive Culinary Product Packaging Training for Cooperatives and SMEs Kab. Bandung. Charity: Journal of Community Service Vol. 2, No. 1, September 2019. ISSN 2655-5336. Available at <<https://journals.telkomuniversity.ac.id/charity/article/view/2067>> . Date accessed: October 17 2022.



**THE INFLUENCE OF EMPOWERMENT AND TRUST TOWARD THE WORK
COMMITMENT OF ADMINISTRATIVE STAFF OF PUBLIC JUNIOR HIGH SCHOOL IN
TEBET DISTRICT, SOUTH JAKARTA, INDONESIA**

Mohammad Ruvi

STIE Ganesha, Economy, Jakarta, Indonesia

Abstract

The aim of this study is to observe the influence of empowerment and trust toward work commitment of the public junior high school administration staff in Tebet District, South Jakarta. The research utilized the quantitative approach with a survey method and applied path analysis in testing the hypothesis. It was involving 65 administration staff with various gender, background and qualification as the respondents, who were selected in a simple random sampling way. The study revealed several results, which are (1). There is a positive direct influence of empowerment on work commitment. (2). There is a positive direct influence of trust on work commitment, and (3). There is a positive direct influence of empowerment on trust.

Keywords : empowerment, trust, work commitment

INTRODUCTION

The existence of school administrative staff is very important in achieving organizational goals. To develop human resources, especially in the context of achieving educational goals, a collaboration between all the components of education is required. Administrative staff is one of the determinants of educational success, because they carry out administrative activities in achieving organizational goals in schools. Their work commitment is very much needed in order to do a good job.

To be able to increase work commitment, one of the efforts that can be done by school principals is to empower their employees. Empowerment is needed to improve administrative management in schools. For this reason, it is very necessary to have trust, awareness, knowledge, and cooperation in order to form a strength and effort to improve administrative services in schools and increase employee's trust towards the principal as the head of school management.

Based on the identification of the problems above, it is known that work commitment can be related to many factors; however, the scope of this study is restricted to trust and empowerment factors, and the symptoms observed are those that are present in the public junior high schools in the Tebet district, South Jakarta, Indonesia.

Work Commitment

Armstrong (2005:136) defines commitment as, *"...a desire to belong to the organization and a willingness to display effort on its behalf"*. That is a desire to be part of an organization and a willingness to show effort as part of that organization. Harris (2002:76) defines that, *"commitment—the willingness of individuals to work toward goals on a continuing basis"*. Commitment is an individual's willingness to work to achieve goals on an ongoing basis. Griffin (2004:74) states that,



"organizational commitment, sometimes called job commitment, reflects an individual's identification with and attachment to the organization." Organizational commitment, sometimes called work commitment, reflects an individual's identification and attachment to the organization.

There are three characteristics of commitment identified by Mowday et al (1982) in Armstrong (2009:229): *"1) A strong desire to remain a member of the organization." That is a strong desire to remain a member of the organization. "2) A strong belief in, and acceptance of, the values and goals of the organization." A strong belief in, and a willingness to accept the values and goals of the organization. "3) A readiness to exert considerable effort on behalf of the organization."* Readiness to put forth sufficient effort for the sake of the organization. Burton, Martin and Nicholls in Mullins describe a model of commitment based on three main pillars, each with three factors: *"a) A sense of belonging to the organization, b) A sense of excitement in the job, c) Confidence in management."*

From the definitions and findings of the experts above, it can be synthesized that work commitment is a desire to be part of an organization and a willingness to show effort in achieving goals on an ongoing basis as part of the organization. This work commitment can be measured through indicators: a) a sense of belonging to the organization, b) a sense of pleasure with work, c) a sense of confidence in management leadership, d) a sense of wanting to work better, e) a sense of having an emotional attachment to the organization and f) desire to remain in the organization.

Empowerment

Empowerment according to Bateman (2006:90) is absorbed from the word empowerment, which is defined as, *"the act of giving someone (such as an employee) the power to take decisions"*. According to Mullins (2005:60) empowerment is generally defined as a way to *"...allowing employees greater freedom, autonomy and self-control over their work, and responsibility for decision-making"*. In this case, employees are given greater freedom, autonomy and self-control (individuals) over their work, as well as responsibility in decision-making. Schermerhorn (2012:289) defines it by: *"empowerment is the process by which managers help others to acquire and use the power needed to make decisions affecting themselves and their work."* Empowerment is the process by which managers help others to gain and use the authority needed to make decisions that affect themselves and their work. Meanwhile, Robbins (2006:14) briefly stated that, *"...empowerment is giving employees responsibility for what they do"*. Empowerment is giving employees responsibility for what they do. While the definition used is *"...empowerment is the freedom and the ability of employees to make decisions and commitments"*. Empowerment is the freedom and ability of employees to make decisions and commitments. Griffin (2014:132) defines that, *"empowerment is the process of enabling workers to set their own work goals, make decisions, and solve problems within their spheres of responsibility and authority"*. Empowerment is a process that allows workers to set their own work goals, make decisions, and solve problems within their scope of responsibility and authority. As Mullins (2005:860) puts it, *"to involve employees is to gain their commitment to the organizational goals, and this has often been couched in terms of empowering employees to take responsibility for their roles and functions within the organization."* To engage employees is to gain their commitment to the goals of the organization, and this has often been written in terms of empowering employees to take responsibility for their roles and functions within the organization. Empowering workers means giving authority or decision-making authority and responsibility from the leadership to workers. For workers to be fully empowered, they must be provided with the information and resources they need to make and implement decisions well, and then be rewarded for individual initiatives. As the definition given by Williams (2007:332) that, *"empowerment is feelings of intrinsic motivation, in which workers perceive their work to have impact and meaning and perceive themselves to be competent and capable of self-determination."* Empowerment is a



feeling of intrinsic motivation, whereby employees feel their work has impact and meaning and consider themselves competent and capable of self-determination.

Based on the description above, it can be concluded that empowerment is an act of giving greater power or authority given to employees to make decisions and given freedom, autonomy and self-control (individuals) as well as responsibility in making decisions on their work, with indicators: 1) authority/autonomy to make decisions, 2) ability to exert influence. 3) the ability to do what is needed, 4) the freedom to choose how to do the job, 5) care about what is done, 6) get the training and resources needed.

Trust

Viewed from the organizational side Pryce (2010:25) defines that, *"trust is about the faith you currently have in your organization."* Trust is the confidence you now have in the organization. Jones (2012: 75) defines trust as, *"trust is an expression of confidence in another person or group of people that you will not be put at risk, harmed, or injured by their actions."* Trust is defined as an expression of confidence in another person or group of people that we would not put them in a position of risk, harm, or injury as a result of their actions. Meanwhile, Weiss (2003:4) argues that, *"to me, trust means that both parties have the underlying conviction that the other person has the partner's absolute best interests in mind."* Trust means that both parties have an underlying belief that the other person in question has good thoughts on the interests of his partner". An alternative definition has also been stated by Shaw (1997) in Armstrong (2009:268) which states that, *"...trust is the belief that those on whom we depend will meet our expectations of them."* Trust is the belief that the people we depend on will fulfill our expectations. Robbins (2009:276) states that, *"trust is a "positive expectation" that another will not—through words, actions, or decisions—act opportunistically."* Trust is a *"positive expectation"* that the other party will not (through words, actions, or decisions) act opportunistically. Robbins identifies 5 key dimensions that underlie the concept of trust, namely: Integrity refers to honesty and truthfulness. are technical and interpersonal knowledge and individual skills. *"Consistency"* relates to reliability, individual predictability and good judgment in handling situations. *"Loyalty"* is the willingness to protect and save the face of others. The last dimension of trust is *"openness"* which is the ability to give the full truth.

Thus it can be synthesized that trust is the belief that employees have towards other people or members of the organization and is a *"positive hope"* that other parties will not act opportunistically through words, actions, or decisions with indicators 1) integrity, 2) competence, 3) consistency, 4) loyalty, and 5) openness.

RESEARCH METHODS

This study uses a quantitative approach, causal associative type with survey methods and path analysis as statistical analysis techniques. This research was conducted from August – October 2014 on 6 public junior high schools in Tebet District with a total administrative staff of 78 people. The sample of the research object was determined by the Slovin formula and produced a research sample of 65 respondents. The data collected is presented in descriptive statistics. Then analyzed using parametric statistic path analysis model, aiming to test the effect between research variables. The path analysis test steps are carried out as follows; data normality test, estimation error normality calculation with Lilifors-test, regression equation calculation, significance test and regression linearity test. Next, the path analysis is calculated, to calculate the path coefficient.



RESULTS AND EXPLANATION

The Effect of Empowerment on Work Commitment.

The results of the simple correlation analysis between empowerment and work commitment obtained a correlation coefficient of $r_{13} = 0.548$ and a path coefficient $\beta_1 = 0.296$. This means that the effect of empowerment on work commitment is significantly positive, meaning that proper empowerment of administrative staff can increase commitment. This is in line with the opinion of several experts including Beardwell (2005:540) who revealed that, *“to involve employees is to gain their commitment to the organizational goals, and this has often been couched in terms of empowering employees to take responsibility for their roles and functions within the organization. While Pilbeam (2006:375) argues that, “Involve your employees. Jack (2004) observes that ‘staff are the best critics of what will or won’t work in an organisation. If your strategy is genuinely one of empowerment, then you will want to involve them from the outset’. It is therefore important that staff are committed also.”* Meanwhile, Pycard (2007:333) states that, *“finally empowerment does not only highlight the commitment of staff but also transfers to them at least part of the control of their jobs.”* Finally empowerment not only highlights staff commitment but also transfers at least part of the job control to them.

From the results of the study, empowerment shows that if empowerment is carried out properly, a high work commitment will be easier to achieve. This is because employees have a desire to be part of an organization where they work and are willing to show effort as part of the organization. The right empowerment will also provide motivation and ultimately empowerment will provide benefits to employees and the organization.

The Effect of Trust on Work Commitment.

Trust has a direct positive effect on work commitment with a correlation coefficient of $r_{23} = 0.466$, and a path coefficient value of $\beta_2 = 0.394$. This means that the influence of trust on work commitment is significantly positive, meaning that high trust in administrative staff can increase work commitment. The results of this study are in line with the opinion of several experts including Jessica Pryce-Jones (2010:108) who said that, *made up of feelings and beliefs – in other words, it consists of a “head and a heart” approach with all the elements working to reinforce and impact one another.”* Jessica Pryce-Jones (2010:235) also explains that, *“trust is also built on organization members following through on their commitments to each other.”* A similar statement was also expressed by Armstrong (2009:480) as follows, *“it retains them (employee) by providing better opportunities and rewards than others and by developing a positive psychological contract that increases commitment and creates mutual trust.”* Meanwhile, Mullins (2005: 902) argues that, *“a large measure of the success of the companies studied derives from their management of people and from creating a climate for commitment.”* Mullins (2005: 903) also emphasizes that, *“because of a high level of trust between members of the organization there is a high level of psychological commitment to the organization.”*

Based on the results of the study, the trust of the administrative staff of Public Junior high schools in Tebet Districts, South Jakarta, it appears that a high work commitment can be achieved by making efforts to increase employee confidence. If the boss or the organization motivates employees by promising them an opportunity, they should be able to get it whenever possible. Likewise, if an employee promises his boss to stay on his job and promises that the organization will benefit if they attend training to learn something new, then trust will occur when employees feel this commitment.



The Effect of Empowerment on Trust.

The research concludes that empowerment has a direct positive effect on trust. The analysis of this study shows a correlation coefficient of $r_{12} = 0.394$, with a path coefficient value of $\beta_{21} = 0.394$. This means that the influence of empowerment on trust is significantly positive, meaning that proper empowerment of administrative staff can increase trust. The results of this study are in line with the opinion of several experts including Wilson (2004:63) who stated that, "true empowerment requires forceful leadership. This paradox emphasizes that empowering workers requires courage at the highest levels." The same thing was expressed by Armstrong (2009: 469), "...one of the aims of job design is often to extend the responsibility of workers into the functions of planning and control. This can involve empowerment – giving individuals and teams more responsibility for decision making and ensuring that they have the training, support, and guidance to exercise that responsibility properly." Meanwhile, Zanini (2007:65) states that, "the degree of empowerment should be directly related to the degree of responsibility. Responsibility will be based on a considerable level of trust invested by management in the form of autonomy."

From the results of the study, it appears that the right empowerment will result in high trust. This can be done by giving a larger portion of responsibility through delegation given to employees. Furthermore, empowerment gives employees greater freedom, autonomy and self-control over their work, as well as responsibility for the decisions they make.

CLOSING

Conclusion: Based on the results of data analysis and discussion, it can be concluded that: 1) There is a positive direct influence of empowerment on work commitment, in the sense that proper empowerment results in high work commitment. 2) There is a positive direct influence of trust on work commitment, in the sense that high trust results in high work commitment. 3) There is a positive direct influence of empowerment on trust, in the sense that proper empowerment results in high trust.

Suggestion: Based on the results of the research, the authors propose the following suggestions: 1) To the Principal: it is suggested that they can delegate decisions as well as autonomy and control over their work. This can be done by providing the necessary training and deepening. In order to increase trust, the principal can make clear game rules and make decisions that are not arbitrary and provide clear reasons why they are enforced. 2) For Administrative Staff: are expected to have a commitment to the organization's mission to provide excellent service to schools and be able to do what has been agreed in accordance with the commitment. In order to increase trust, Administrative Staff are expected to have a reliable nature and have general work ethics. 3) For the DKI Jakarta Provincial Education Office: it should be able to carry out empowerment efforts through activities aimed at increasing the capacity of school principals and administrative staff. It is also expected to provide the information and resources needed. In order to increase trust, officials can provide the necessary authority so that schools can make their own decisions.



BIBLIOGRAPHY

- Armstrong, Michael, *Armstrong's Handbook of Human Resource Management and Practice*. London and Philadelphia: Kogan Page Limited, 2009.
- Armstrong, Michael, *Employee Reward Management and Practice*. London and Philadelphia: Kogan Page Limited 2005.
- Bateman, Heather, McAdam, Katy, *Dictionary of Human Resources and Personnel Management*. London: A & C Black Publishers Ltd, 2006.
- Beardwell, Ian, Holden, Len dan Claydon, Tim, *Human Resource Management*. Edinburgh: Pearson Education Limited, 2005.
- George, Jennifer M dan Jones, Gareth R. *Understanding and Managing Organizational Behavior*. New Jersey: Pearson Education, Inc., 2012.
- Griffin, Ricky W. dan Moorhead, Gregory, *Organizational Behavior: Managing People and Organizations*. Mason: South-Western, Cengage Learning, 2014.
- Harris, O. Jeff, PhD dan Hartman, Sandra J., PhD, *Organizational Behavior*. New York, London & Oxford: Best Business Books 2002.
- Langton, Ngriffancy dan Robbins, Stephen P., *Fundamental of Organizational Behavior*. Canada: Pearson Education, 2006.
- Mullins, Laurie J, *Management and Organisational Behaviour*. Harlow: FT Prentice Hall, 2005.
- Pilbeam, Stephen dan Corbridge, Marjorie, *Human Resource Management*, Harlow: Pearson Education Limited, 2006.
- Pryce-Jones, Jessica. *Happiness at Work*, Chichester: Wiley-Blackwell, 2010.
- Pycard, Mike, Singh, Hemmanth and Phihlela, Khomotso, *Operations Management*. Harlow: Pearson Education Limited, 2007.
- Robbins, Stephen T., Judge, Timothy A & Hasham, Elham S, *Organizational Behavior*. Harlow: Pearson Education Limited, 2009.
- Schermerhorn, *Organizational Behavior*. Danvers: John Wiley & Sons, Inc., 2012.
- Weiss, Alan PhD, *Organizational Consulting*. New Jersey: John Wiley & Sons, Inc., 2003.
- Williams, Chuck, *Management*. Harlow: South-Western, 2007
- Wilson, John P, *Human Resource Development*. London: Kogan Page Limited, 2004.
- Zanini, Marco Tulio *Trust Within Organizations of the New Economy*. New Jersey: Springer Science+Business Media, 2007.



**DISTANCE LEARNING AND MASTERY OF ACCOUNTING MATERIALS AT STIE
GANESHA**

Ika Agustina

Melati Puspita Hakim

STIE Ganesha, Economy, Jakarta, Indonesia

Abstract

As is known, the pandemic has hit the world for more than two years, from early 2019 to early 2021. Many aspects of life must change to adapt to these conditions. Many sectors are also affected. STIE Ganesha as a higher education institution that organizes the teaching and learning process must also adapt to this condition. One of the real actions is to organize distance learning to avoid the spread of the Covid 19 outbreak for all study programs at STIE Ganesha including the accounting study program. It is undeniable that accounting is one of the subjects that is considered difficult for students because there are many mathematical calculations in it. With this change in the teaching and learning process, we will examine the extent of its influence on the mastery of accounting material. In this study, qualitative methods will be used. The population of this research is STIE Ganesha students who are taking introductory accounting courses. This introductory accounting course was chosen with the consideration that all students must take this course. After doing this research, it is hoped that it can be used as an evaluation material for STIE Ganesha in organizing its teaching and learning process in the new normal era which can be held with various methods, although it is undeniable that mastery of a course material is not only influenced by one variable.

Keywords: Pandemic, distance learning, material mastery, accounting



THE EFFECT OF MOTIVATION ON EMPLOYEE PERFORMANCE AT PT. RAJAWALI GARDA NUSANTARA

Muhamad Ridwan

Fuki Lukianto

Sekolah Tinggi Ilmu Ekonomi Ganesha Jakarta, Indonesia

Abstract

The purpose of this study was to determine the effect of motivation on employee performance at PT. Rajawali Garda Nusantara. The method used in this research is quantitative method, with validity test analysis technique, reliability test, simple linear regression test. The sample used was 77 respondents, namely the entire population. The results of this study are that there is a positive and significant influence of motivation on employee performance at PT Rajawali Garda Nusantara with a contribution of R² (R Square) of 51.8%. Suggestions in this study are expected management to increase the award for employee achievement so that employees can improve employee performance by improving the quality of their work.

Keywords: Motivation, performance

INTRODUCTION

The development of an organization is strongly effected by the human resources in the organization, this is because its role is very important in achieving organizational goals, without quality human resources, organizational goals will not be achieved. Therefore we need a good management of human resources so that these human resources can work in accordance with what is expected by the organization.

Likewise, an organization in this case is a private organization, inseparable from the impacts caused by global developments, both positive and negative effects, it all depends on how the personnel involved in it are able to work together and act professionally and reliably in dealing with them. Thus, organizational leaders are required to be able to mobilize, mobilize and organize all organizational components in realizing the goals to be achieved, including utilizing and optimizing the use and management of their resources.

Thus, it is necessary to carry out continuous and sustainable development or management of human resources through the application of human resource management, because humans are created to have different talents and abilities.

PT. Rajawali Garda Nusantara is a company engaged in security services and the provision of manpower, especially security guards and other outsourcing personnel in order to provide workers from companies throughout Indonesia.

PT. Rajawali Garda Nusantara is well aware of the importance of support from quality human resources in an effort to achieve organisational goals. Support from qualified human resources without being supported by good work motivation will prevent organisational goals.

Motivation, stimulation or driving force, which stimulates or encourages employees to want to work vigorously differently from one employee to another. This difference is caused by differences in the motives, goals and needs of each employee to work, also because of differences in time and place.



Therefore, in providing motivation to employees, it must be investigated which stimulating power is more effective to apply and more emphasised.

With high work motivation, it is expected to increase employee work productivity which will ultimately affect the performance of employees in carrying out the work or tasks given or are the responsibility of each employee. Because employee labour motivation greatly affects the performance of an employee.

One form of human resource development is the application of performance appraisal or commonly known as performance appraisal, which is a process where an organisation or company evaluates the performance that has been carried out by its employees within the specified period of time. Through this process the management of the company/ organisation/ institution can obtain some information that can be used in the management of the organization/ institution as a whole and to determine what activities or actions must be carried out at any given time.

In addition, performance appraisals can also be used by managers in determining career planning, development and research, payment of promotional service rewards and labour compliance. Whereas the human resources division, information obtained from performance appraisal can be used to evaluate the success of recruitment, selection, orientation, placement, training and other activities.

If applied correctly, performance appraisals can have an effect on increasing employee motivation. Because employees are assessed to expect a lot from the performance appraisal both during the thought process and from the final results of the assessment.

One factor that affects the success rate of an organisation is the performance of its employees. According to Robbins (2016) Employee performance is employee work performance during a certain period compared to various possibilities, such as standards, targets/goals or criteria that have been predetermined and mutually agreed upon.

From the results of temporary observations made by the author at the research site, it can be seen that the performance of employees in completing tasks and work is still not what the organisation expects. This can be seen from the still tasks and work that is completed not on time and there are still employees who like to procrastinate doing the tasks and work given causing a buildup of tasks and jobs. The tendency of this condition, according to the author, is due to the lack of motivation of employees at work, causing employee performance to decrease.

Based on the above, the author is interested in conducting further research on the true state of how the ship's marine life is in shipping safety, which the author poured into a scientific paper entitled: **“The Effect of Motivation on Employee Performance at PT Rajawali Garda Nusantara Jakarta.”**

PROBLEM FORMULATION

Is there an effect of Motivation on Employee Performance at PT Rajawali Garda Nusantara Jakarta?

RESEARCH OBJECTIVES

Based on the Problem Formulation above, the purpose of the research is to find out the effect of Motivation on Employee Performance at PT Rajawali Garda Nusantara Jakarta.

THEORETICAL FRAMEWORK

Motivation

Robbins and Judge (2009) "Motivation refers to the process by which a person's efforts are energised, directed, and sustained toward attaining a goal". Here motivation is defined as the process by which one's efforts are generated, directed, and maintained to achieve goals/goals. Motivation is a process or force that exists in a person that is driven by physiological or psychological needs.



Ahmad Tohardi (2012: 334) gives the following meaning: "Motivation is a strong force (push) from within a person to carry out activities in accordance with that motivation".

According to Siagian (2017: 128) Motivation is the whole process of providing motivation to work to subordinates in such a way that they are willing to work sincerely in order to achieve organisational goals efficiently and economically.

According to Hasibuan (2017: 143) motivation is the provision of movement that creates a person's work activities, so that they are willing to cooperate, work effectively and integrate with all efforts and efforts to achieve satisfaction.

Based on the understandings above, it can be concluded that motivation is an activity to invite by encouraging someone to make someone work

Performance

Performance according to Mangkunegara (2009: 67) is the result of quality and quantity of labour achieved by an employee in carrying out tasks in accordance with the responsibilities assigned to him.

According to Prawirosentono (2017:1) providing an understanding of performance is the result of work that can be achieved by a person or group of people in an organisation, in accordance with their respective authorities and responsibilities, in order to achieve the goals of the organisation concerned legally, not violating the law and in accordance with morals or ethics.

In general, it can be said that performance is a measure of the success of a person or group of people in an organisation in achieving goals.

Based on the entire frame of mind above, the conceptual model design of research can be described in figure 1 as follow:

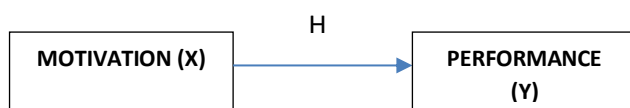

Figure 1. Research Model Design

RESEARCH HYPOTHESIS

There is an effect of Motivation on Employee Performance at PT Rajawali Garda Nusantara Jakarta.

RESEARCH METHODS

This study is verifiable descriptive. Descriptive research is research that aims to obtain a description (clear and detailed explanation) of motivation and performance at PT Rajawali Garda Nusantara Jakarta. Whereas verifiable research is research that aims to determine the relationship, effect between variables through hypothesis testing based on data collected in the field or verification properties basically want to test the bearability of a hypothesis.

The types of investigations carried out are causality and correlational, which are types of research that state causal relationships between independent variables, in this case Motivation towards dependent variables, namely Performance at PT Rajawali Garda Nusantara Jakarta.

To review all research problems, the necessary data is obtained through field surveys using questionnaires. Then analyse and describe all problems through data analysis, statistical calculations and data interpretation.

In this study the population was 77 employees.

Operational Variables

Variable operations are an element of research on how to measure a variable, both independent



variables and dependent variables. A research variable is an attribute or trait or value of a person, object or activity that has a certain variable set by the researcher to study and draw conclusions (Sugiono 2012:3).

The definition of Operational variables intended to clarify the variables that are the main focus of this study are as follows:

1. Motivation (X) as a independent variable
2. Performance (Y) as a dependent variable

Table 1 Operational Variables

Variables	Dimension	Indicator
Motivation (X)	Physiological Needs	a. Salary according to standard b. Needs met
	Safety Needs	a. Safe at work b. Health insurance
	Social needs	a. Parts of the organization b. Interaction
	Self-esteem needs	a. Pride b. appreciation
Performance (Y)	Quality of Work	a. Best quality b. JobSatisfaction
	Promptness	a. Matching the target b. Presence
	Initiative	a. Independence b. Ideas
	Communication	a.Communication b. Appreciation

RESEARCH RESULTS

Validity Test

a. Motivation

Source: SPSS Data Processing version 24

Based on the table above it can be seen that for each statement on the Motivation variable (X) all items prove valid, because the resulting count value is greater than the existing table value for n = 77 which is 0.221.

Table 2
Motivation Variable Validity Test

Dec	Work Motivation (X)		
	r count	r table n = 77	Statement
1	0.609	0.221	Valid
2	0.581	0.221	Valid
3	0.597	0.221	Valid
4	0.687	0.221	Valid
5	0.677	0.221	Valid
6	0.638	0.221	Valid
7	0.612	0.221	Valid
8	0.581	0.221	Valid

**b. Performance**

Table 3
Performance Variable Validity Test

Dec	Performance (Y)		
	r count	r table n = 77	Statement
1	0.756	0.221	Valid
2	0.740	0.221	Valid
3	0.756	0.221	Valid
4	0.747	0.221	Valid
5	0.708	0.221	Valid
6	0.557	0.221	Valid
7	0.553	0.221	Valid
8	0.410	0.221	Valid

Source: SPSS Data Processing version 24

Based on the table above, it can be seen that for each statement on the Employee Performance variable (Y) all items prove valid, because the calculated value produced is greater than the existing table value for $n = 77$ which is 0.221.

Reliability Test**a. Work Motivation**

Table 3
Motivational Reliability Test

Reliability Statistics	
Cronbach's Alpha	N of Items
.769	8

Source: SPSS Data Processing version 24

From the table above it can be seen that the Motivation variable is said to be reliable, because the value of Cronbach's Alpha is greater than the table which is $0.769 > 0.600$ with the provision of $N=8$ a significant level of 5%.

b. Performance

Table 4
Performance Reliability Test

Reliability Statistics	
Cronbach's Alpha	N of Items
.799	8

Source: SPSS Data Processing version 24

From the table above, it can be seen that the performance variable is said to be reliable, because Cronbach's Alpha value is greater than the table which is $0.799 > 0.600$ with the provision of $N=8$ a significant level of 5%.



Determination Coefficient Test

Table 5 Coefficient of Determination

Model Summary ^b				
Model	R	R Square	Adjusted R Square	Std. Error of the Estimate
1	.720 ^a	.518	.512	2.620

a. Predictors: (Constant), MOTIVATIONAL

b. Dependent Variable: PERFORMANCE

Source: SPSS Data Processing Version 24

Based on the table above, an R² (R Square) value of 0.518 was obtained. This shows that 51.8 % of Motivation has an effect on Employee Performance, while the remaining 48.2% is effected by other variables not studied in this study.

Simple Linear Regression Analyser

Table 6 Regression Test

Coefficients ^a					
Model	Unstandardized Coefficients		Standardized Coefficients	t	Sig.
	B	Std. Error	Beta		
1 (Constant)	5.762	2.984		1.931	.057
MOTIVATION	.834	.093	.720	8.982	.000

a. Dependent Variable: PERFORMANCE

Source: SPSS Data Processing version 24

Based on the table mentioned above, the linear regression equation is simply as follows: $Y = 5.762 + 0.834 x$

The hypotheses in this study were tested using Test t. If you pay attention to the results of the table above, the calculated value for the Motivation variable (X) to Employee Performance (Y) is 8,982, while the table value for n=77 is 1,665. So because the count value > table, which is 8,982 > 1,665. Probability value (significance) = 0.000 which is below 0.050 thus Ha is accepted, it can be concluded that there is a positive and significant effect of the Motivation variable (X) on Employee Performance (Y).

DISCUSSION

Effect of Motivation on Performance

Factors that affect performance according to A. A. Anwar Prabu Mangkunegara (2009:67-68) is as follows:

A. Ability factor



Employees who have an IQ above average (IQ 110-120) with adequate education for their positions and are skilled in carrying out daily tasks, these employees will better achieve the performance expected by the company. Employees therefore need to be placed in jobs that match their expertise.

B. Motivation factors

Motivation is divided into two parts, namely internal motivation and external motivation. Internal motivation is motivation that comes from within employees, for example mental behaviour. An employee is expected to have a commendable attitude, namely having the desire to work optimally in order to achieve satisfactory performance in accordance with company expectations. In addition, employees are also required to have a steel mentality, not give up easily, and are not easily discouraged if they experience difficulties, obstacles or even failures. External motivation is motivation that comes from outside the employee, for example work atmosphere, welfare, future prospects. External motivation also affects employees in carrying out daily activities.

The results of the research are in line with research conducted by Indra Jaya (2012) entitled The effect of ability and motivation on the performance of employees of the West Tanjung Jabung Regency Education Office, the conclusion of the motivation and Work Ability research together has a positive and significant effect on performance.

CONCLUSION

There is a positive and significant effect of motivation on employee performance at PT Rajawali Garda Nusantara, Jakarta with a contribution of R^2 (R Square) of 51.8%.

ADVICE

1. Management increases the award of employee achievement.
2. Enhance employee performance by improving the quality of work.
3. Leaders provide encouragement to further enhance teamwork.

BIBLIOGRAPHY

- Hasibuan, Malayu S. P. (2017). *Manajemen Sumber Daya Manusia* Edisi revisi. Jakarta : Bumi Aksara.
- Indra Jaya (2012) *Pengaruh kemampuan dan motivasi terhadap kinerja pegawai Dinas Pendidikan Kabupaten Tanjung Jabung Barat*.
- Mangkunegara, A. A. Anwar Prabu. 2011. *Manajemen Sumber Daya Manusia Perusahaan*. Bandung : PT. Remaja Rosdakarya.
- Rawirosentono, Suyadi. (2017). *Manajemen Sumber Daya Manusia Kebijakan Kinerja Karyawan*. Yogyakarta : BPFE.
- Robbins, Stephen P., and Thimoty Judge (2009). *Organization Behavior ; 13th Edition*. New Jersey : Pearson Education, Inc
- Sugiyono (2016). *Metode Penelitian Administrasi*. Bandung : CV. Alfabeta.
- Siagian, Sondang P. (2017). *Manajemen Sumber Daya Manusia*. Jakarta : Bumi Aksara.
- Tohardi, Ahmad. (2013). *Pemahaman Praktis Manajemen Sumber Daya Manusia*. Bandung : Mandar Maju.



**THE WORK ABILITY TO PROMOTE THE JOB PERFORMANCE OF MEMBERS OF
THE POLICE OF THE REPUBLIC OF INDONESIA (CAUSAL STUDY ON POLICE
MEMBERS AT LEBAK POLRES)**

Yumhi

La Tansa Mashiro College of Economics
Graduate program

Abstract

This study aims to obtain information related to the possibility of whether job performance is influenced by work ability, work interest and job satisfaction. Using a causal study through a survey of members of the Lebak Police Police, Banten, Indonesia, with a population of 858 police officers, using a positive sample obtained a sample of 53 police officers. data for each variable was collected separately by the respondents who filled out the questionnaire. The method used in this study is a quantitative survey method, while the analytical techniques used are correlation and regression.

The results prove that there is an effect of work ability on job performance, there is an influence of work interest on job performance. there is an effect of job satisfaction on job performance, there is a joint influence of work ability, work interest, and job satisfaction on job performance.

These findings indicate that organizations need to consider the variables of work ability, work interest, and job satisfaction in planning and developing human resources at the Lebak District Police.

Keywords: Work Ability, Work Interest, and Job Satisfaction, Job Performance, Lebak District Police



PHOTOCATALYTIC REMOVAL OF PESTICIDES

Sevil AKÇAĞLAR

Dokuz Eylül University, Department of Mechanical Engineering, Buca-İzmir, Turkey

Abstract

TiO₂/GO/CuFe₂O₄ was produced under laboratory conditions for enhancing the photocatalytic degradation of two chlorinated pesticides namely endrine and endosulfan under UV light irradiation from surface water. Effects of increasing doses of TiO₂/GO/CuFe₂O₄ nanocomposite (0.5 mg/L, 1, 1.5, 2.0, 2.5 and 3.0 mg/L), of GO/CuFe₂O₄ ratios (0.1, 0.5, 1, 1.5), increasing UV light powers (20 W/m², 40 W/m²; 60 W/m² and 80 W/m²) and of photooxidation times (10mn, 20 min, 40 min and 60 min) on the removal yields of endrine and endosulphan were investigated. The maximum 3 mg/L endrine and 5 mg/L endosulphan photodegradation yields were 99% and 98%, respectively at a UV power of 60 W after 20 min contacting time at a TiO₂/GO/CuFe₂O₄ nanocomposite dose of 1.5 mg/L and at a GO/CuFe₂O₄ concentration of 0.5 mg/L. XRD profile of TiO₂/GO/CuFe₂O₄ nanocomposite exhibited a crystalline anatase TiO₂ peaks and nanocomposite contained low percentage of GO and CuFe₂O₄. The EDX spectrum of the composite showed the presence of individual Ti, Cu, C, Fe, and O elements.

Key words: Endosulfan, Endrine, TiO₂/GO/CuFe₂O₄, Surface water, Photodegradation



REMOVAL OF A DYE USING NANOCOMPOSITE VIA ADSORPTION

Sevil AKÇAĞLAR

Dokuz Eylül University, Department of Mechanical Engineering, Buca-İzmir, Turkey

Abstract

The aim of this research was to remove an organic dye namely Alizarin yellow using xanthan poly(vinylimidazole) nanocomposite via adsorption. 10 mg/L alizarin yellow dye was removed via adsorption to 0.15 mg/L xanthan poly(vinylimidazole) nanocomposite with a maximum adsorption yield of 98% at acidic Ph of 4.0 after 40 min adsorption time. XRD pattern of xanten with poly(vinylimidazole) results showed that two peaks located at $2\theta = 32^\circ$ and 33° illustrating the semicrystalline nature of nanocomposite. SEM results showed that xanten structure consists of different types of rough and porous materials.

Keywords: Alizarin yellow dye, poly(vinylimidazole), nanocomposite, pH, adsorption time



TÜRKİYE’DEKİ AFET YÖNETİM SİSTEMİNİN DEĞERLENDİRİLMESİ

Hatice Kıran Çakır

Rukiye Duygu Çay

Trakya Üniversitesi, Mimarlık Fakültesi, Mimarlık Bölümü, Edirne, Türkiye.

Trakya Üniversitesi, Mimarlık Fakültesi, Peyzaj Mimarlığı Bölümü, Edirne, Türkiye.

Özet

Afet, insan için, fiziksel, ekonomik ve sosyal kayıplar doğuran, normal yaşamı ve insan faaliyetlerini durdurarak veya kesintiye uğratarak, toplulukları etkileyen ve etkilenen topluluğun kendi imkân ve kaynaklarını kullanarak üstesinden gelemeyeceği olayların doğurduğu sonuçlardır. Afetin büyüklüğü, olayın fiziksel boyutundan, kalabalık yerleşim yerlerine uzaklığından, toplumun gelişmişlik düzeyinden, hızlı nüfus artışından, kontrolsüz kentleşme ve sanayileşmeden, çevrenin yanlış kullanılmasından ve yetkililerin önlem almamasından etkilenmektedir. Afetler doğal ve beşeri olmak üzere iki gruba ayrılmaktadır. Bunlar arasında teknik farklılıklar olmakla birlikte, kesin bir sınır olduğunu söylemek mümkün değildir. Afetle sonuçlanabilecek olayların önlenmesi veya kayıplarının azaltılması afet yönetim sistemi ile mümkündür. Afet yönetim sistemi; afet öncesi ve sonrasında yapılacak faaliyetleri toplumun tüm kesimlerini kapsayacak şekilde planlamak; yönlendirmek; desteklemek; koordine etmek, gerekli mevzuat ve kurumsal yapıları oluşturmak; tüm kurum, kuruluşları ve kaynakları yönetmektir. Bu yönetimin ortak hedefler doğrultusunda yapılması gerekmektedir. Afet yönetim sistemi, afetin zararlarını en aza indirmek için afet öncesi (kayıp azaltma ve hazırlık süreçleri) ve afet sonrası (müdahale ve iyileştirme süreçleri) yapılması gerekenleri belirten süreçler bütünüdür. Tüm bu süreçler iç içedirler ve birbirleri ile etkileşim halindedirler. Bu döngüsel bir süreci ifade etmektedir. Etkin bir afet yönetim sistemi için tüm süreçlerin koordineli bir şekilde yönetilmesi gerekmektedir. Afet öncesi hazırlık ve zarar azaltma çabalarının artırılması, afet sonrası ihtiyaçları da azaltacaktır. Böylece daha dirençli bir toplum ve daha güvenli yerleşim alanları oluşturulabilecektir. Mevzuat, afet yönetim sisteminin iyileştirilmesi ve kurumsallaşması için en güçlü araçtır. Çalışma, Türkiye’deki afet yönetim sürecinin mevzuat açısından sorgulanmasını ve yapılabilecek iyileştirmelerinin geliştirilmesini amaçlamaktadır. Bu nedenle çalışmada, Türkiye’deki mevzuat, kırılma noktası olarak kabul edilen 1999 yılı öncesi ve sonrası dönemler olarak ele alınmaktadır. Çalışma sonucunda, ülkemizdeki mevzuatın genellikle afet sonrası süreçler ile ilgili olduğu, afet öncesi süreçler ile doğrudan ilgili olan yasa ve yönetmeliklerin ise oldukça yetersiz olduğu tespit edilmiştir. Çalışma ile imar planlaması ve bu planlamadan sorumlu birimlerin birbirleri ile iletişim halinde olması durumunda ancak güvenli bir toplumun yaratılabileceği vurgulanmıştır.

Anahtar kelimeler: Afet, afet yönetim sistemi, afet öncesi, afet sonrası.

Abstract

Disasters are the results of events that cause physical, economic and social losses, affect communities by stopping or interrupting normal life and human activities, and that the affected community cannot overcome by using their own means and resources. The magnitude of the disaster is affected by the physical dimension of the event, its distance from crowded settlements, the level of development of the society, rapid population growth, uncontrolled urbanization and industrialization, misuse of the environment and failure of the authorities to take precautions. Disasters are classified into two groups, natural and human. Although there are technical differences between them, it is not possible to say that there is a definite limit. Prevention of events that may result in disasters or



reducing their losses is possible with disaster management. Disaster Management system; It is to plan, direct, support and coordinate the activities to be carried out before and after the disaster in a way to cover all segments of the society, to establish the necessary legislation and institutional structures, and to manage all institutions, organizations and resources. This management needs to be done in line with common goals. Disaster management system is a set of processes that specify what needs to be done before disaster (loss reduction and preparedness processes) and after disaster (response and recovery processes) in order to minimize the damages of the disaster. All these processes are intertwined and interact with each other. This represents a cyclical process. For an effective disaster management system, all processes must be managed in a coordinated manner. Increasing pre-disaster preparedness and mitigation efforts will reduce post-disaster needs. Thus, a more resilient society and safer residential areas will be created. Legislation is the most powerful tool for the improvement and institutionalization of disaster management. The study aims to question the disaster management process in Turkey in terms of legislation and to develop possible improvements. Therefore, in this study, the legislation in Turkey is considered as the periods before and after 1999, which are accepted as the breaking point. As a result of the study, it has been determined that the legislation in our country is generally related to the post-disaster processes, and the laws and regulations directly related to the pre-disaster processes are quite inadequate. In the study, it is emphasized that a safe society can only be created if all planning levels and the units responsible for these planning are in communication with each other.

Keywords: Disaster, disaster management system, pre-disaster, post-disaster.

GİRİŞ

İnsanlık tarihinin başlangıcından itibaren barınma temel ihtiyacından doğan yapılaşma ve buna bağlı olarak kentleşme, geleceğimizde de etkisini sürdürmeye devam edecektir. İnsanlığın varoluşundan günümüze kadar geçen zaman içerisinde, onların sosyal, ekonomik, psikolojik olarak etkilenmesine ve değişmesine neden olan; maddi olarak kayıplara ve yıkımlara; manevi olarak ise yaşamdan kopmalarına, yaralanmalarına veya sakat kalmalarına neden olan felaketleri, afet olarak tanımlamak mümkündür. Afetler; bir olayın meydana gelişi olmayıp, o olayın sonucunda oluşmaktadırlar. Afetlerin oluşumlarına bakıldığında, doğal ya da beşeri (insanlara bağlı) nedenlere bağlı olarak meydana gelebilmektedirler.

Afetler kökenlerine göre, beşeri ve doğal afetler olarak ikiye ayrılmaktadırlar. Deprem, volkan patlaması, toprak kayması, kaya ya da çığın düşmesi, kasırga, sel vb. insanın kontrolü dışında olan ve sadece Dünya'nın özelliklerinden dolayı meydana gelen afetler "doğal afet" olarak tanımlanmaktadır. Bunlar, meteorolojik ve jeolojik kökenli olanlar olarak kendi içerisinde ikiye ayrılmaktadırlar. Doğal afetler gibi kendiliğinden olmayıp, oluşumunda insanların büyük etkisi olan, orman yangını, salgın hastalık, savaş vb. afetler ise insanlardan kaynaklanan afetler ise "beşeri afet" olarak tanımlanmaktadır. Her felaketi, afet adı ile tanımlamak mümkün değildir. Felaket sonucunda, yiyecek-içecek temin etmede, barınma ihtiyaçlarının giderilmesinde, haberleşmede, tedavi etmede, defin işlemlerinde vb. durumların karşılanmasında çok büyük sorunlar yaşanması durumunda, bu felaket, afet olarak nitelendirilmektedir.

Birleşmiş Milletler afeti, "etkilenen toplumun sadece kendi kaynaklarının kullanılması ile çözümün bulunamadığı, etkilenenlerin maddi, manevi veya çevresel kayıplarının çok fazla olmasına sebebiyet veren, toplumun mevcut durumunu önemli ölçüde olumsuz etkileyen" olarak tanımlanmaktadır (The United Nations, 1992). Afetin özellikleri; maddi ve manevi kayıplara neden olması, çok kısa bir zamanda oluşması ve başlamasından sonra insanların buna engel olamamasıdır (Kahyaoğlu, 2016). Ancak afetlerden zarar görebilirlik seviyesi, bireylerin ve toplumların sosyal ve ekonomik özelliklerine bağlıdır (Cannon, 1994).

AFET YÖNETİM SÜRECİ



Toplumlarda, afet sürecinin iyi ve etkili yönetilmesi ile süreç yönetilmekte ve gelişmektedir. Afet yönetim süreci ile insanların ölmesinin ve yaralanmasının minimuma indirilmesi hedeflenmektedir (Schramm, 1993). Bu süreç iki evreden meydana gelmektedir. Afetin yaşanmasından önceki dönemler olan risk ve zarar azaltma aşaması ile öncesinden hazırlık aşamasını kapsayan ve afet anında kişisel davranış ve korunma konularının Risk Yönetimi evresi ve afet sonrasındaki dönemde ise müdahale aşaması ve iyileştirme aşamasını kapsayan Kriz Yönetimi evrelerinden oluşmaktadır (Gökçe ve Tetik, 2012). Bu süreç, afetin olması muhtemel alanlarda yaşamakta olan insanların bütün olanaklarının afet öncesinde ve afet sonrasında dikkatli ve bilinçli kullanımının gerekli olduğu geniş kapsamlı evrelerin bir bileşkesidir. Afet Yönetim Süreci, doğal veya beşeri afetlerden kaynaklanacak, maddi ve manevi tehlikeler oluşturacak durumlar ile baş edebilmek ve bunları önlemek için plan ve programlar geliştirmek ve bunları yerine getirmek için yapılacak süreci tanımlamaktadır (Sylves, 1996). Bu döngüsel süreci, birbirlerini takip eden ve birbirlerine bağlı olan anlamlar bütünü olarak tanımlamak mümkündür.

Risk ve zarar azaltma evresi, afetin sonrasında olması muhtemel zararların en aza indirilmesini ve mümkün ise zarar görülmemesini hedeflemektedir. Bu evre, afet yönetim sürecindeki önlem alıcı evrelerden biridir. Uzun dönemde insanları maddi ve manevi kayıplar ile mal ve yaşam kayıplarını tehdit eden etmenlere karşı alınacak oldukça kapsamlı ve planlı önlemler olarak tanımlanmaktadır (McLoughlin, 1985). Önlemler bütünü olarak ifade edilen bu evre, toplumun gelişmişlik düzeyi, kentsel planlama ve mühendislik kavramları ve onların uygulanması ile ilgili teknikler üzerine kurulmuştur (Ataman ve Tabban, 1977). Evrede, afet öncesi alınması gerekli önlemler ve toplumu bilgilendirmek amaçlanmaktadır.

Hazırlık evresi, yönetsel olarak tüm planların hazırlanmasını ve oluşması muhtemel olan afetlere ilişkin çalışmaların yapılmasını kapsayan evredir. Afet toplanma alanlarının belirlenmesi, imar planlarının hazırlanması, afet ile ilgili yasa ve yönetmeliklerin uygulanması ve geliştirilmesi hazırlık evresinde oluşturulmaktadır. İl düzeyinde Kurtarma ve Acil Yardım Planları'nın yapılması, görev ve sorumluluğu olan ilgililerin eğitilmesi ve tatbikatlar ile bilgilerinin geliştirilmesi, gerekli olması durumunda bölgesel malzeme merkezlerinin hazırlanması ve depolanması, erken uyarı sistemlerinin kurulması, işletilmesi, geliştirilmesi vb. temel çalışmalar bu evrede yapılmaktadır. Afet Yönetim Süreci'nin bu iki evresi Risk Yönetimi olarak tanımlanmaktadır (Gökçe ve Tetik, 2012; URL 1).

Müdahale evresinde, afet sonucu zarara uğramış kişilerin kurtarılması, ilkyardım çalışmaları bulunmaktadır. Haberleşme ve ulaşım, ihtiyaçların tespiti, arama-kurtarma, tedavi, tahliye, geçici barınma, yiyecek, giyecek, yakacak temin edilmesi, güvenlik, çevrenin sağlığı, hasarın belirlenmesi, tehlikeli yıkımların kaldırılması ve ikincil afetlerin önlenmesi temel hedeflerdendir. Bu evrede, afet toplanma alanlarının oldukça önemli olduğu vurgulanmaktadır (AFAD, 2014).

İyileştirme evresi, afet nedeni ile oluşan zararların ve kayıpların büyüklüğüne göre tüm eksikliklerin tamamlanmasını ve yenilenmesini hedeflemektedir. Bu evrede yapılan çalışmaların amacı; afete maruz kalmış toplulukların haberleşmesini sağlamak, uzun süreli geçici barınmalarına çözüm bulmak, ulaşım, su, elektrik, kanalizasyon, eğitim, ekonomik ve sosyal faaliyetler vb. ihtiyaçlarının karşılanmasıdır. Afet Yönetim Süreci'nin bu iki evresi Kriz Yönetimi olarak tanımlanmaktadır (Gökçe ve Tetik, 2012, URL 1).

Evrelerin tamamı birbirleri ile etkileşim içerisinde, bir döngü oluşturmaktadır. Tüm evrelerin, Afet Yönetim Süreci içerisinde tek bir sistem gibi eşgüdümlü olarak yönetilmesi gerekmektedir. Bu nedenle evreler bütünlük olarak ele alınmalıdır (Şekil 1). Yaşanmış olan afetlerden edinilen tecrübeler ve gelişen bilimsel çalışmaların etkileri sayesinde bu süreç geliştirilebilecektir.



Şekil 1. Afet Yönetim Süreci ve evreleri (URL 1’den geliştirilmiştir)

TÜRKİYE’DE AFET YÖNETİM SİSTEMİ

Ülkemiz, jeolojik yapısı, meteorolojik ve topografik özelliklerine bağlı olarak zaman içerisinde pek çok afet ile karşı karşıya kalmış bir ülkedir. Bu nedenle, 1939 yılında afet yönetim sistemine ve süreçlerine ilişkin yasal olarak temel atılmıştır. Fakat son yaşanan afetlerdeki sistemlerde tam anlamıyla oturmayan eksiklikler fark edilmiştir. Ülkemizde mevcut olan afet mevzuatına bakıldığında, afetlere ilişkin bütüncül ve geniş bir bakış açısı bulunsa da, afet yönetim sisteminin kurumsal yapısı ve tüm afet türlerinin aynı başlıkta ele alınmasından dolayı eksiklikleri bulunmaktadır (Genç, 2007, 387-406; Balamir, 1999: 13; Özmen vd., 2013; 128). Türkiye’de yaşanan 1999 depremi sonrası dönem, kırılma noktası olmuştur. Afet planlarını etkileyen kanunların büyük çoğunluğu, bu tarihten sonra çıkarılmıştır. Afet yönetim planları da bu tarihten sonra oluşturulmaya başlanmıştır.

Ülkemizde ilk olarak, 1939’da meydana gelen depremden sonra kanunlar çıkarılmaya başlanmıştır. Böylece, depremden sonra yapılması gerekenler hakkında, yöneticilerin ve halkın yapması gerekli görev ve sorumlulukları belirli esaslara bağlanmıştır (URL 3). İlgili kanunda ülkede deprem tehlikesi olan yerlerin belirlenmesi ve buralarda yapılması planlanan yapılar ile ilgili yaptırımlar bulunmaktadır. 1953’de, Bayındırlık Bakanlığı’na bağlı olarak, deprem bürosu oluşturulmuştur. 1955’de, büro DE-SE-YA (deprem-sel-yangın) şubesi olarak değiştirilmiş ve doğal afetlerin zararlarını azaltma çalışmalarını yürütmek ile görevlendirilmiştir (URL 3). 1958’de, 7116 sayılı kanun ile İmar ve İskân Bakanlığı kurulmuştur. 7269 sayılı kanunun, 1959’da çıkarılması ile afetlere bağlı olarak alınması gereken önlemler ve yapılacak yardımlar belirlenmiştir. Kanun ile o tarihe kadar çıkarılan tüm kanunlar tek bir kanun altında toplanmıştır. İlgili kanun, 1968’de büyük oranda değiştirilmiştir. Bu tarihlerde, Afet İşleri, Sivil Savunma Genel Müdürlükleri ve Kızılay kurulmuştur. 1999’dan önce yasalarda doğal afetlerin verdiği zararların azaltılması ile ilgili doğrudan maddeler olmasa da, çıkarılan kanunların dolaylı olarak afetin zararlarını azaltmaya yönelik çalışmalara katkısı olmuştur (Akyel, 2007, Çalışkan, 2019). Ülkemizde 1999 yılından itibaren çıkarılan kanunlar; yılları, kanun adı ve açıklamaları ile birlikte Tablo 1’de yer almaktadır.



Tablo 1. 1999 yılı ve sonrası afet ile ilgili çıkarılan kanunlar (Akyel, 2007; Çalışkan, 2019'dan geliştirilmiştir)

Yıl/Sayı	Kanun Adı/Tipi	Açıklama
1999/4452	Doğal Afetlere Karşı Alınacak Önlemler ve Doğal Afetler Nedeniyle Doğal Zararların Giderilmesi İçin Yapılacak Düzenlemeler Hakkında Yetki K.	Doğal afetlere karşı alınacak önlemlerin belirlenmesi, zararların giderilmesi, fonların işleyişi için Bakanlar Kuruluna üç ay süre ile KHK çıkarma yetkisi
1999/574	Umumi Hayata Müessir Afetler Dolayısıyla Alınacak Tedbirlerle Yapılacak Yardımlara Dair Kanunda Değişiklik Yapılması Hakkında KHK	Kendilerine ait olmayan arsa ve araziler üzerinde ruhsatsız yapı sahiplerine Bayındırlık ve İskân Bakanlığınca konut yapabilme yetkisi
1999/575	Doğal Afet Bölgelerinde Afetten Kaynaklanan Hukuki Uyuşmazlıkların Çözümüne ve Bazı İşlemlerin Kolaylaştırılmasına İlişkin KHK	Delil ve tespit için resmi kayıtların bulunamaması halinde avukatların işlem yetkisi
1999/576	Doğal Afetlerde Yapılacak Yardımların Düzenlenmesi İle Vergilerin Ödeme Sürelerinin Uzatılmasına ve Bazı Kanunlarda Değişiklik Yapılmasına Dair KHK	Merkezi hesapta toplanan paraların öncelikle afetzedelerin her türlü ihtiyaçlarını ve konut yapımında kullanılması hakkında Bayındırlık ve İskân Bakanlığınca aktarılması
1999/577	Umumi Hayata Müessir Afetler Dolayısıyla Alınacak Tedbirlerle Yapılacak Yardımlara Dair Kanuna Bir Geçici Madde Eklenmesi Hak. KHK	1999 depremi sonrası hasar gören Türk Silahlı Kuvvetlerine bağlı yapıların tüm yetkileri Milli Savunma Bakanlığı ve İçişleri Bakanlığınca bağlanması
1999/578	Bazı Kanunlarda Değişiklik Yapılması Hak. KHK	Deprem, su baskını, yangın gibi afetlerden etkilenen sigortalı vatandaşların sigorta prim borçlarının ertelenmesi
1999/579	Milli Piyango İdaresi Genel Müdürlüğü Kuruluş ve Görevleri Hakkında Kanun Hükmünde Kararnameye Bir Madde Eklenmesine Dair KHK	Afetzedelere ve bölgelere özel çekiliş düzenlenmesi
1999/580	Umumi Hayata Müessir Afetler Dolayısıyla Alınacak Tedbirlerle Yapılacak Yardımlara Dair Kanuna Geçici Maddeler Eklenmesine Dair KHK	Afete maruz kalan gerçek ve tüzel kişilerin hazine arazisi üzerine konut yapabilme izni ve afetten zarar gören kamu personeline yardım konuları
1999/581	Bazı Kanunlarda Değişiklik Yapılmasına Dair KHK	Afetlerden dolayı yerleşim alanı ihtiyacı için mera vasfı taşıyan arazilerin ve orman alanlarının konut yapımında kullanılmak üzere Bayındırlık ve İskân Bakanlığınca aktarılması
1999/582	Afetten Doğan Zararların Giderilmesi Hak. KHK	1999 Depremi nedeniyle kamu kurumlarına mal ve hizmet alımında ödenemeyen miktarın Mahalli İdare Fonu tarafından karşılanması
1999/583	Başbakanlığın Teşkilatı Hakkında KHK'nin Değiştirilerek Kabulü Hakkında Kanunda Değişiklik Yapılmasına Dair KHK	Türkiye Acil Durum Yönetimi Başkanlığı (TAY) kurulması
1999/586	Sivil Müdafaa Kanunu ile Belediye Kanununda Değişiklik Yapılmasına Dair KHK	Sivil Savunma müdürlüğü kurulması ve savunma fonunun kullanımını
1999/587	Zorunlu Deprem Sigortasına Dair KHK	Zorunlu Deprem Sigortasına ilişkin usul ve esaslar
2000/4539	Doğal Afet Bölgelerinde Afetten Kaynaklanan Hukuki Uyuşmazlıkların Çözümüne ve Bazı İşlemlerin Kolaylaştırılmasına İlişkin KHK'nin Kabulü H. K.	Afete maruz bölgelerde afetten kaynaklanan hukuki uyuşmazlıkların giderilmesi
2000/595	Yapı Denetimi Hakkında KHK	Yapı denetim sistemi
2000/596	Sivil Savunma Kanununda Değişiklik Yapılmasına Dair KHK	Sivil savunma müdürlüklerinde sözleşmeli personel istihdam edilmesi
2000/597	Umumi Hayata Müessir Afetler Dolayısıyla Alınacak Tedbirlerle Yapılacak Yardımlara Dair Kanuna Bir Geçici Madde Eklenmesi Hak. KHK	177871999 ve 1271171999 depremleri sonrası yıkılan ve hasar alan konut kooperatiflerinin üyelerine tek bir üyelik için tek bir hak tanınması
2000/598	Umumi Hayata Müessir Afetler Dolayısıyla Alınacak Tedbirlerle Yapılacak Yardımlara Dair Kanunda Değişiklik Yapılması Hak. KHK	Afetzedelerin iskân etmeleri için kullanılması ve yeni yerleşim alanlarına yapılacak kalıcı konutların afet fonundan karşılanması



Tablo 1. Devamı

Yıl/Sayı	Kanun Adı/Tipi	Açıklama
2000/599	Umumi Hayata Müessir Afetler Dolayısıyla Alınacak Tedbirlerle Yapılacak Yardımlara Dair Kanunda Değişiklik Yapılması Hak. KHK	Afetlerden etkilenen bölgelerde yeni yapılacak tip projeleri, yapıları, sosyal altyapıları, sağlık, okul, hastane ihtiyaçları
2000/600	Başbakanlık Teşkilatı Hakkında Kanun Hükmünde Kararnamenin Değiştirilerek Kabulü Hakkında Kanunda Değişiklik Yapılmasına Dair KHK	Türkiye Acil Durum Yönetimi Başkanlığı, Türkiye Acil Durum Yönetimi Genel Müdürlüğü haline getirilmesi
2000	Sivil Savunma Arama ve Kurtarma Birlikleri ve Ekiplerinin Kuruluşu, Görevleri, Çalışma Usul ve Esaslarına Dair Yönetmelik	Sivil Savunma genel Müdürlüğüne bağlı ekiplerin kuruluş ve görevleri usul ve esaslar
2001/4708	Yapı Denetimi Hakkında Kanun	Yapı denetim sistemine ilişkin usul ve esaslar
2002	Binaların Yangından Korunması Hak. Yönetmelik	Yapılarda yangın hakkında alınabilecek tedbirler, organizasyon, eğitimi ve denetim
2006/5511	Umumi Hayata Müessir Afetler Dolayısıyla Alınacak Tedbirlerle Yapılacak Yardımlara Dair Kanunda Değişiklik Yapılmasına İlişkin Kanun	Yapılacak yapılar için alınan yardımları ve TOKİ konutlarının yetkiisini ve satın alma esasları
2007	Deprem Bölgelerinde Yapılacak Binalar Hak. Yönetmelik	Deprem bölgelerinde yapılacak yapıların dayanıklı olması için uygulanacaklar
2009/5902	Afet ve Acil Durum Yönetimi Bakanlığının Teşkilat ve Görevleri Hak. Kanun	Afet ve Acil Durum Yönetimi Başkanlığı kurulması ve yetkilerini kapsar
2011/644	Çevre ve Şehircilik Bakanlığının Teşkilat ve Görevleri Hak. K. H. K.	Depreme karşı dayanıksız yapılar ile imar mevzuatına, plan, proje ve eklerine aykırı yapıların ve bunların bulunduğu alanların dönüşüm projeleri
2011/645	Orman ve Su İşleri Bakanlığının Teşkilat ve Görevleri Hak. K. H. K.	Çığ, heyelan ve sel kontroflündeki havzaların ıslahı
2012	Afet Ve Acil Durum Yönetimi Başkanlığı Araştırma Etüt ve Proje Yaptırma Usul ve Esaslarına Dair Yönetmelik	AFAD tarafından ihtiyaçları doğrultusunda araştırma, proje, etüt yaptırılması, yerli ve yabancı kaynak kullanılması
2012	Ulusal Deprem Araştırma Programı Proje Destekleme Esaslarına Dair Yönetmelik	Ulusal Deprem Araştırma Programına ilişkin usul ve esaslar
2012/6305	Afet Sigortaları Kanunu	Sigorta teminat ve içerikleri
2012/6306	Afet Riski Altındaki Alanların Dönüştürülmesi Hak. Kanun	Afet riski altındaki alanların dönüştürülmesi hakkında usul ve esaslar
2014/6525	Bazı Kanun ve Kanun Hükmünde Kararnamelerde Değişiklik Yapılması Hak. K.	İl afet ve acil durum müdürlükleri ile Afet ve Acil Durum Arama ve Kurtarma Müdürlükleri AFAD'a bağlanması
2014	Mekânsal Planlar Yapım Yönetmeliği	Planlarda afet, jeolojik ve doğal veriler, risk azaltıcı tedbirlerin esas alınması, tehlike ve risklerin analiz edilerek tanımlanması ve imar planlarında afet ve acil durumlarda ihtiyaç duyulabilecek yol, açık alan ve diğer mekânsal ihtiyaçlar
2016/5393	Belediye Kanunu Afet Durum Planlaması	Afetlerin zararlarını azaltmak için afet ve acil durum planlarını hazırlaması
2018	Türkiye Bina Deprem Yönetmeliği	Yeniden yapılacak, değiştirilecek, bütütülecek resmi ve özel binaların tamamının veya bölümlerinin deprem etkisi altında tasarımı ve yapımı ile mevcut binaların deprem etkisi altındaki performanslarının değerlendirilmesi ve güçlendirilmesi için gerekli kuralların ve minimum koşulların belirlenmesi

Ülkemizde, afet yönetimi ve tarihçesi incelendiğinde, birçok kanunun 1999 depreminden sonra çıkarıldığı görülmektedir. Merkezi yönetim, ortaya çıkan sorunları en kısa sürede çözebilmek için Türkiye Büyük Millet Meclisi'nden (TBMM) Kanun Hükmünde Kararname (KHK) çıkarma yetkisi 4452 sayılı yetki yasası ile almıştır. Çıkarılan kanunlar incelendiğinde, çoğunluğunun afetten sonrasını kapsadığı görülmektedir.



TÜRKİYE’DE AFET YÖNETİMİ VE İMAR MEVZUATLARI İLE İLİŞKİSİ

Ülkemizde afet ve afet yönetimi planları ile ilgili sorumluluk AFAD (Afet ve Acil Durum Yönetimi Başkanlığı)’da bulunmaktadır. Bünyesinde, afet ve acil durumlar ile ilgili müdahale planları ile ilgili TAMP (Türkiye Afet Müdahale Planı), afet ve acil durumlarda bütün kaynakların etkin olarak yönetilmesinden Afet Yönetim ve Karar Destek Sistemi Projesi (AYDES) sorumludur. 2009’da kurulan AFAD, deprem risklerinin azaltılmasını ve deprem ile mücadele etmek için toplumun bilinçlendirilmesini hedeflemektedir. AFAD, dayanıklı yapılar inşaa edilirken aynı zamanda konu ile ilgili Ar-Ge çalışmalarının yapılmasından; eğitim ile ilişkili akreditasyon esaslarının belirlenmesinden; afet ve acil durumlar ile ilgili eğitim hizmetleri veren tüm paydaşların akreditasyonunu sağlamaktan sorumludur. Afet müdahale planlarının oluşturulması, görev ve sorumlulukların belirlenmesi yetkisi AFAD’da bulunmaktadır (Yağcı, 2008).

TAMP, afet ve acil durumlarda müdahalelerde görevli olacak hizmet gruplarını, sorumluluk ve görevlerini açıklayarak, afet öncesi, sırası ve sonrasında ilişkin müdahale planlamalarının ana ilkelerini belirlemektedir (AFAD, 2013). TAMP, ülkesel ve yerel ölçekte afet ve acil durumlarda müdahale çalışmalarının yürütmesi ile ilgili yöntemin belirlendiği ve bir üst ölçekli plan olan, olası afet ve acil durum türlerine ve ölçeklerine göre uyarlanabilir, esnek ve modüler bir yapıya sahip müdahale organizasyon sistemini tanımlamaktadır. TAMP, ülkemizde ulusal, il ve yerel ölçeklerdeki müdahale planlarını içermektedir. Plan türlerine bakıldığında, afet türlerine göre bütünleşik olarak bu planlara geçilecek esaslar uygulanmaktadır. Afet risk ve zarar azaltma ile afet iyileştirme planları da bu kapsamda yapılmaktadır (Şekil 2). TAMP, ülkemizde yaşanması muhtemel tüm tür ve ölçeklerdeki, afet ve acil durumlarda görevli olacak, bakanlık, kurumlar, özel kuruluşlar, STK’lar ve gerçek kişilerden oluşmaktadır (Tablo 2).



Şekil 2. Türkiye Afet Yönetimi Strateji Planı Türleri (Gerdan, 2021; URL 2)



Tablo 2. Türkiye’de Afet Yönetiminde Görevli Kurum ve Kuruluşlar

Afet Yönetiminde Görevli Kurum ve Kuruluşlar	Afet Yönetimi İle İlgili Görev ve Sorumlulukları
Çevre ve Şehircilik Bakanlığı	Afetlerden önce ve sonra meskûn alanlarda alınacak tedbirler, yapılacak yardımların tespit etmek, bunların uygulanmasını sağlamak, imar planlarını afetlere karşı etkili bir biçimde hazırlamak, denetlemek ve bu konulardaki ilgili bakanlık, kurum ve kuruluşlarla işbirliği yapmak görevleri arasındadır.
İller Bankası Genel Müdürlüğü	Yerel yönetimlerin imar hizmetleri ve teknik altyapı yatırımları ile her türlü ekonomik ve teknik destek sağlamak görevleri arasındadır.
Türkiye Kızılay Derneği	Afet hizmetinin gereğine uygun olarak yapılabilecek insani, maddi, malzeme, tıbbi yardım ve diğer yardım hizmetleri dağıtımını sağlamak görevleri arasındadır.
Türk Silahlı Kuvvetleri (TSK)	Doğal afetler sonucu arama ve kurtarma için hava, deniz, kara üzerinden askeri yardım yaparak gerekli ise güvenliği sağlamak görevleri arasındadır.
Genelkurmay Başkanlığı	TSK'nın yapacağı yardımların yapılmasını, denetlenmesi ve acil yardımlara ilişkin esasları belirlemek görevleri arasındadır.
Sağlık Bakanlığı	İlk yardım hizmetlerini etkili, hızlı ve ihtiyaca yönelik olarak hizmetleri yürütmek, bulaşıcı ve salgın hastalıkları kontrol altına almak, personel, araç, tıbbi malzeme ihtiyaçlarını zamanında karşılamak görevleri arasındadır.
Ulaştırma ve Altyapı Bakanlığı	Afetten etkilenen bölgenin iletişim, ulaşım ihtiyaçlarını karşılamak, nakilleri sağlamak, yurtdışından gelen yardımların dağıtımını sağlamak görevleri arasındadır.
İçişleri Bakanlığı	Afetten etkilenen bölgenin emniyetini sağlamak, bölgeye giriş çıkışı kontrol etmek, Ulaştırma ve Altyapı Bakanlığı ve diğer bakanlıklarla koordinasyonu sağlamak, afetlerde görevli personelin eğitimini sağlamak görevleri arasındadır.
Dışişleri Bakanlığı	Afetten sonra yurtdışı yardımları için iletişime geçmek, koordinasyonu sağlamak ve yurtdışı haberleşmeyi sağlamak görevleri arasındadır.
Ekonomi Bakanlığı	Afetler fonundaki paranın kontrol edilmesi, yetmediği durumlarda ödenek bulması, hazineye ait arazi ve gayrimenkullerin temini görevleri arasındadır.
Tarım ve Orman Bakanlığı	Afetlerden etkilenen hayvanların insan sağlığına zararsız hale getirilmesi, yakacak ihtiyacını karşılaması, içme suyu ihtiyacı ve bu suyun dezenfekte edilmesi, afetten zarar gören çiftçilere yardım edilmesi görevleri arasındadır.
Sanayi ve Teknoloji Bakanlığı	Afet bölgesi için ihtiyaç ve malzemelerin ivedilikle tahsisi, etkilenen kritik sanayi yapılarının tespiti ve onarılması, özel sanayi yapıları için kredi ve devreye sokulması görevleri arasındadır.
Enerji ve Tabii Kaynaklar Bakanlığı	Afet kış mevsiminde ise yakacak için tedbir alma, bölgenin enerji ihtiyacını giderme görevleri arasındadır.
AFAD	Her türlü afet öncesi, sırası ve sonrası için planlamayı yapmak, görev ve teşkilatlanmayı sağlamak ve müdahale için ekip kurmak görevleri arasındadır.
Aile ve Sosyal Politikalar Bakanlığı	Afet sonrası aileler, çocuklar, kimsesiz kalanlar için koordineli bir şekilde hizmet vermesi görevleri arasındadır.
Milli Eğitim Bakanlığı	Afet sonrası uzun süreler için kesilen eğitim hizmetinin devam etmesi ve tedbirleri alması görevleri arasındadır.
Sivil Toplum Kuruluşları (STK)	Afet ile alakalı her türlü STK, afet için gerekli yardımlar için, hasar tespiti için mühendis ve mimar barındıran STK'lar afetlerden sonra görev alabilir.

AYDES (Afet Yönetimi ve Karar Destek Sistemi), TAMP'ın bilişim altyapısıdır. Bu sistem, coğrafi açıdan yapılandırılmış, afet ve acil durumlarda bütün kaynakları etkili biçimde kullanıp yöneten, karar destek mekanizmalarını bünyesinde bulunduran internet tabanlı bilgi sistemi uygulamasıdır. Bu uygulama, olay komuta sistemi, mekânsal bilgi sistemi ve iyileştirme sistemi olarak üç farklı bileşenden oluşmaktadır.

3194 sayılı İmar Kanunu, 5216 sayılı Büyükşehir Belediyesi Kanunu, 5393 sayılı Belediye Kanunu ve Mekansal Planlar Yapım Yönetmeliği gibi bazı kanunların ve yönetmeliklerin afet ile doğrudan ilişkili olduğu tespit edilmiştir. Bunlara bağlı olarak inşaa edilecek yapıların da kanunlara göre



yapılması amaçlanmaktadır. Belediye kanununda, afete ilişkin çalışmalar yapılmış ve yönetimin yetki ve sorumlulukları belirlenmiştir. Kentsel dönüşüme ilişkin kanunlarda, afet riski altındaki dayanıksız yapıların dönüştürülmesi ile ilgili esaslar bulunmaktadır. İmar Yönetmeliği'nde ise yerel yönetimlerin yetkileri ve afet planlarındaki etkileri vurgulanmaktadır. Planlı Alanlar Tip İmar Yönetmeliği, yeni inşaa edilecek yapıların afet riskine bağlı olarak ölçüleri, çıkmaları, arsada bırakılacak yeşil alanları belirtilmektedir. Deprem Yönetmeliği'nde, yapıların afet durumunda daha dayanıklı olabilmelerini sağlayacak gerekli önlemler belirlenmiştir. Ancak, ancak bu 2019'da yeniden ele alınarak mevcut hesaplamalarında değişiklik yapılmıştır. Sığınak Yönetmeliği ve Yangın Yönetmeliği ile belirli ölçülerdeki yapılarda afetlere karşı kaçış için merdiven, söndürme sistemi, sığınak için zorunlu alan sınırları belirlenmiştir. Tablo 3'de afet planlarının imar mevzuatı ile ilgili yer aldığı kanunlar bulunmaktadır.

Tablo 3. Afet Planlarının İmar Mevzuatında Yer Aldığı Kanunlar

Yıl/Sayı	Belge Adı/Tipi	Afet Yönetimine Katkısı
1999/585	İl Özel İdaresi Kanunu'na Madde Eklenmesi Hak. KHK	Afet nedeniyle meydana gelen zararların giderilmesi yetkileri
1999/586	İmar Kanunu'nda Değişiklik Yapılmasına Dair KHK	Belediyelerin afet konusunda yetki ve görevlerinin belirlenmesi
2004/5216	Büyükşehir Belediyesi Kanunu	Doğal afetler ile ilgili planlamaları büyükşehir ölçeğinde oluşturmak ve acil durum hizmetlerini yürütmek
2005/5302	İl Özel İdaresi Kanunu	Afet ve acil durum planlama yetkisi
2005/5393	Belediye Kanunu	Acil durum planlama yetkisi ile afet ve acil durum planlama yetkisini beldenin özelliklerine bakarak yapma yetkisi
2011/644	Çevre ve Şehircilik Bakanlığının Teşkilat ve Görevleri Hakkında Kanun Hükmünde Kararname	Depreme karşı dayanıksız ve imar mevzuatına aykırı yapıların ve bunların bulunduğu alanların dönüşüm projelerini ve uygulamalarını yapmak, yapı denetimi sistemini oluşturmak
2011/645	Orman ve Su İşleri Bakanlığının Teşkilat ve Görevleri Hakkında KHK	Çığ, heyelan, sel baskını ile havzaların ıslah planlarını ve projelerini yapmak
2014	Mekânsal Planlar Yapım Yönetmeliği	Planlarda afet, jeolojik ve doğal veriler, risk azaltıcı tedbirlerin esas alınması, tehlike ve risklerin analiz edilerek tanımlanması ve tedbirlerin alınması, afet ve diğer kentsel risklerin yüksek olduğu yerleşmeler ile imar planlarında afet ve acil durumlarda ihtiyaç duyulabilecek açık alan, yol ve diğer mekânsal ihtiyaçların gözetilmesi
2015	Büyükşehir Belediyeleri ve İl Özel İdareleri Tarafından Afet ve Acil Durumlar ile Sivil Savunmaya İlişkin Yatırımlara Ayrılan Bütçeden Yapılacak Harcamalara Dair Yönetmelik	Afet ve acil durumlar için ödeneğin belirlenmesi ve harcanması yetkisini kapsar
2016/5393	Belediye Kanunu Afet Durum Planlaması	Afetlerin zararlarını azaltmak için afet ve acil durum planlarını hazırlamasını kapsar
2016/6306	İmar Kanunu Afet Riski Altındaki Alanların Dönüştürülmesi HK	Riskli alanların belirlenerek kentsel dönüşüm kapsamında yıkılması ve yeniden yapılması esaslarını kapsar
2017/3194	Planlı Alanlar Tip İmar Yönetmeliği	Yapılacak binaların afet etkisi altında, hesaplara göre kapalı çıkma hesapları, bodrum hesapları ve bırakılacak yeşil alan hesaplarını kapsar
2010/27802	Sığınak Yönetmeliği	Binalarda bazı afetlere karşı sığınak özelliklerini, standartlarını kapsar
2007/12937	Binaların Yangından Korunması Hakkında Yönetmelik	Binalarda yangın merdiveni zorunluluğunu, söndürme sistemlerini ve standartlarını kapsar
2019	Bina Deprem Yönetmeliği	Yapılacak binaların afetlere karşı taşıyıcılık bakımından dayanıklılığı hakkında esas ve usulleri kapsar



SONUÇ

Çalışma sonucunda, afet planlarının kapsamlı bir uygulama sistemlerinin bütünü olduğu görülmektedir. Afet planları oluşturulurken birçok kurum ve kuruluşun, organizasyon ve etkileşim içerisinde olması gerekliliği ortadadır. Afet yönetimi ve afet öncesinde yapılması gerekenler ile ilgili ülkemizde, birebir ilişkili mevcut yasa ve yönetmeliklerin yetersiz olduğu tespit edilmiştir. Mevcutlar ise dolaylı olarak etki edebilmektedir.

Afet öncesindeki risk ve zarar azaltma evresinde, kentlerin afete hazırlıklı olarak kurulması için AFAD ile birlikte belediyeler, Çevre, Şehircilik ve İklim Değişikliği Bakanlığı birincil derecede sorumludurlar. Bunların sorumlulukları kanunlar ile belirtilmiştir. Kanunlara bakıldığında, afet ile ilgili maddelerin, afet yönetim sisteminin, görevlerinin vb. usul ve esasların bulunduğu, ancak inşaa edilecek yapılara ilişkin kanunların yetersiz olduğu görülmektedir. Bu nedenle, imar yönetmeliği ile temelleri atılan ve yaşanmış olan afetlerden sonra bu kanunlar geliştirilmiş ve değiştirilmiştir.

İmar planlaması ile ilgili kanun ve yönetmeliklerde, açık ve yeşil alanlara aktivite temelli (çocuk oyun alanı, dinlenme alanı, spor alanı vb.) olarak, sınırlı bir yaklaşım ile bakılmaktadır. Bunlarda, sadece kişi başına 10 m² standardına vurgu yapılmaktadır. Açık ve yeşil alanların, afet riskini azaltma politikalarındaki önemleri dikkate alınmamaktadır (Çelik, vd. 2017).

Ülkemizde mevcut olan yasalar genellikle, afet sonrası müdahale çalışmaları ve bunun organizasyonu ile ilgilidir. Bunlar da AFAD'ın görevlerini kapsamaktadır. Afet öncesi yapılması gerekenlerin yönetimi ile ilgili doğrudan çıkan yasa ve yönetmelikler ise oldukça yetersizdir.

Afet yönetim planları belirli bir sistemler bütünüdür. Bu bütün, evrelerden oluşan döngüsel bir süreci ifade etmektedir. İlgili yasa ve yönetmelikler çerçevesinde geriye dönük olarak tekrar yapılma, revise olma ve takip edilme gereklilikleri bulunmaktadır. Tüm planlama ölçeklerinde, özellikle de imar planlamasında, planlamadan sorumlu kurum ve kuruluşların birbirleri ile iletişim-etkileşim kurarak çalışmaları gerekmektedir. Ancak böyle bir durumda bu planlar uygulanabilir olacaktır. Türkiye'de TAMP kapsamında yapılması gereken çalışmanın, Çevre, Şehircilik ve İklim Bakanlığı ve Mekânsal Planlama Genel Müdürlüğü tarafından da kontrol edilmesi ve yapılan çalışmaların yerel yönetimlere bildirilmesi ve uygulamasının da denetlenmesi gerekmektedir.

KAYNAKLAR

- AFAD, 2013. "Türkiye Afet Müdahale Planı" (TAMP), s: 2-15.
- AFAD, 2014. Açıklamalı Afet Yönetimi Terimleri Sözlüğü, Başbakanlık Afet ve Acil Durum Yönetimi Başkanlığı (AFAD), Ankara. s: 33-41
- Akyel, R., 2007. Afet Yönetim Sistemi: Türk Afet Yönetiminde Karşılaşılan Sorunların Tespit ve Çözümüne İlişkin Bir Araştırma, Doktora Tezi, Çukurova Üniversitesi Sosyal Bilimler Enstitüsü, Adana, s: 9-17.
- Ataman, O. ve Tabban, A 1977. Türkiye'de Yerleşme Alanlarının Doğal Afetler ile İlişkileri. Mimarlık Dergisi, s:153.
- Balamir, M 1999. Mimari Tasarımda Deprem Bilincinin Geliştirilmesi, Mimarlık, 290: 46- 48.
- Cannon, T 1994. Vulnerability Analysis and the Explanation of Natural Disasters, Varley, A. (Editör). Disasters, Development and Environment. London John Wiley, pp: 13-30
- Çalışkan, M C 2019. Afet Yönetim Planlarının Uygulanabilirliğinin İncelenmesi: Çorlu Örneği, Trakya Üniversitesi, Fen Bilimleri Enstitüsü Yayınlanmamış Yüksek Lisans Tezi, s: 5-60
- Çelik, H Z, Özcan, N S ve Erdin, H E 2017. Afet ve Acil Durumlarda Halkın Toplanma Alanlarının Kullanılabilirliğini Belirleyen Kriterler. 4. Uluslararası Deprem Mühendisliği ve Sismoloji



Konferansı, Anadolu Üniversitesi, Eskişehir.

Genç, F N 2007. Doğal Afet Riskleri ve Türkiye’de Kentleşme, ICANAS’38 (Asya ve Kuzey Afrika Çalışmaları Kongresi, s.387-406.

Gerdan, S 2021. Kentsel Planlama Açısından İl Afet Risk Azaltma Planlarının Değerlendirilmesi, Gümüşhane Üniversitesi Sağlık Bilimleri Dergisi, 10(4), s:1006-1013

Gökçe, O, Tetik, Ç 2012. Teoride ve Pratikte Afet Sonrası İyileştirme Çalışmaları, Afet ve Acil Durum Yönetimi Başkanlığı Yayınları, Ankara, s: 8-39

Kahyaoglu B 2016. Tekirdağ Kentinde Doğal Afet ve Eğitim Parkı Planlaması Üzerine Bir Çalışma. Yayınlanmamış, Yüksek Lisans Tezi. Namık Kemal Üniversitesi Fen Bilimleri Enstitüsü. Tekirdağ

McLoughlin, D 1985. A Framework for Integrated Emergency Management. Public Administration Review.

Özmen, B. (Ed.) 2017. Afet Yönetimi-II. Eskişehir: Anadolu Üniversitesi

Schramm, D., 1993. Overview of Disaster Management. Emergency Türkiye 93-First International Disaster Relief and Prevention, Civil Defence, Public Security and First Aid Exhibition.

Sylves R T 1996. The Political Policy Basis of Emergency Management, New York: FEMA

The United Nations, Department of Humanitarian Affairs. 1992. Internationally Agreed Glossary of Basic Terms Related to Disaster Management. (DNA/93/36).

URL 1. <https://www.medak.org.tr/faydali-bilgiler/faydali-bilgiler/> [21.05.2018]

URL 2. <https://www.afad.gov.tr/turkiye-afet-mudahale-plani> [12.04.21]

URL 3. <https://www5.tbmm.gov.tr/sirasayi/donem27/yil01/ss278.pdf> [02.03.2021]

Yağcı A L 2008. Afet Yönetmeliğinin, İstanbul İli İçin Türkiye Afet Bilgi Sistemi Obje Kataloğuna Aktarılması. İstanbul Teknik Üniversitesi Fen Bilimleri Enstitüsü, Yayınlanmamış Yüksek Lisans Tezi, İstanbul, s:18-41.



BAYESIAN-BASED HYPERPARAMETER OPTIMIZATION OF CNN MODELS TO CLASSIFY HISTOPATHOLOGICAL IMAGES

Kübra Uyar
Sümeýra Büşra Şengül
Şakir Taşdemir
İlker Ali Özkan

Selcuk University, Technology Faculty, Computer Engineering Department, Konya, Turkey

Abstract

Convolutional Neural Network (CNN) is a kind of Deep Learning (DL) method especially used in image-based applications such as classification, detection, and segmentation. Training and topology hyperparameters are significant for DL methods since they directly affect the training process and performance of the learning models. Since the hyperparameter search space is very large, determining the best training and topology hyperparameters of the CNN model are very hard and testing the models is computationally expensive. In this study, we proposed a Bayesian optimization method that uses the Bayesian theorem to determine the best hyperparameters for the classification of histopathological kidney, lung, and spleen images. The section depth, maximum epoch, initial learning rate, momentum coefficient of optimizer, learning rate drop factor, and L2 regularization was confined to the hyperparameter search space. The design of CNN architecture with configurations and training hyperparameters calculated by Bayesian search obtained 97.97% average accuracy depending on all histopathological datasets. Experimental results claim that the selected topology and training hyperparameters as a result of Bayesian optimization obtained satisfactory result and this optimization approach can be used for the hyperparameter initialization process.

Keywords: Bayesian optimization, classification, convolutional neural network, hyperparameter, optimization

INTRODUCTION

Bayesian optimization method that bases Bayesian theorem establishes over the objective function and collects the information from the previous sample to update the following of the objective function.

A variety of studies about CNN hyperparameter analysis in the literature have been reviewed. Uyar et. al (2022) designed a fuzzy tree model for the analysis and optimization of CNN topology and training hyperparameters using ten well-known CNN pre-trained models. Depending on the selected CNN pre-trained model and hyperparameter set, classification performances were predicted and the most suitable hyperparameter set was determined. Yeh et. al (2021) optimized hyperparameters using simplified swarm optimization approach and tested on Cifar10, MNIST, and Fashion-MNIST datasets. Soyulu et. al (2020) developed a genetic algorithm-based hyperparameter optimization library and they applied their approach to plant disease detection problems. Singh et. al (2021) recommended a multi-level particle swarm hyperparameter optimization. Andoine and Florea (2020) aimed an algorithm named weighted random search, a combination of random search and probabilistic greedy heuristic. Wang et. al. (2020) developed perceptual hash algorithm to analyze the network structure and select the optimal hyperparameters. Yoo (2019) recommended a univariate dynamic encoding approach for the optimization of deep network hyperparameters using



MNIST dataset. They supported the idea that their proposed approach obtained fast convergence speed and few computational costs comparing some optimization algorithms such as simulated annealing, genetic algorithm, and particle swarm optimization. Soon et. al (2018) proposed a particle swarm optimization method to obtain ideal parameters and ensure better network convergence and classification performance. Bochinski et. al (2017) applied an evolutionary algorithm-based framework to optimize CNN hyperparameters automatically using the MNIST dataset.

Bayesian optimization method is a successful hyperparameter tuning approach that works effectively and quickly since it selects hyperparameters based on previous information. The main objective and novelty of this study are to improve the classification accuracy of the proposed CNN models by identifying suitable training hyperparameters and training design choices for CNN topology.

The remainder of this paper is organized as follows. Section 2 presents a detailed description of the Bayesian optimization. The implementation details are described in Section 3. Experimental results and discussion are expressed in Section 4. Finally, Section 5 summarizes the main conclusion of this work.

BAYESIAN OPTIMIZATION APPROACH FOR DL HYPERPARAMETER OPTIMIZATION

Bayesian hyperparameter optimization method constructs a probability model of the objective function that is used to select more successful hyperparameter set. This optimization method tracks the past evaluation results to propose smarter choices for the next set of hyperparameters.

The initial CNN architecture and Bayesian optimizer are the main parts of the proposed approach as illustrated in Figure 1. Hyperparameter selection, fitness function calculation, and hyperparameter tuning constitutes the Bayesian optimization steps. After finding optimum hyperparameters using Bayesian optimizer, the test process is carried out.

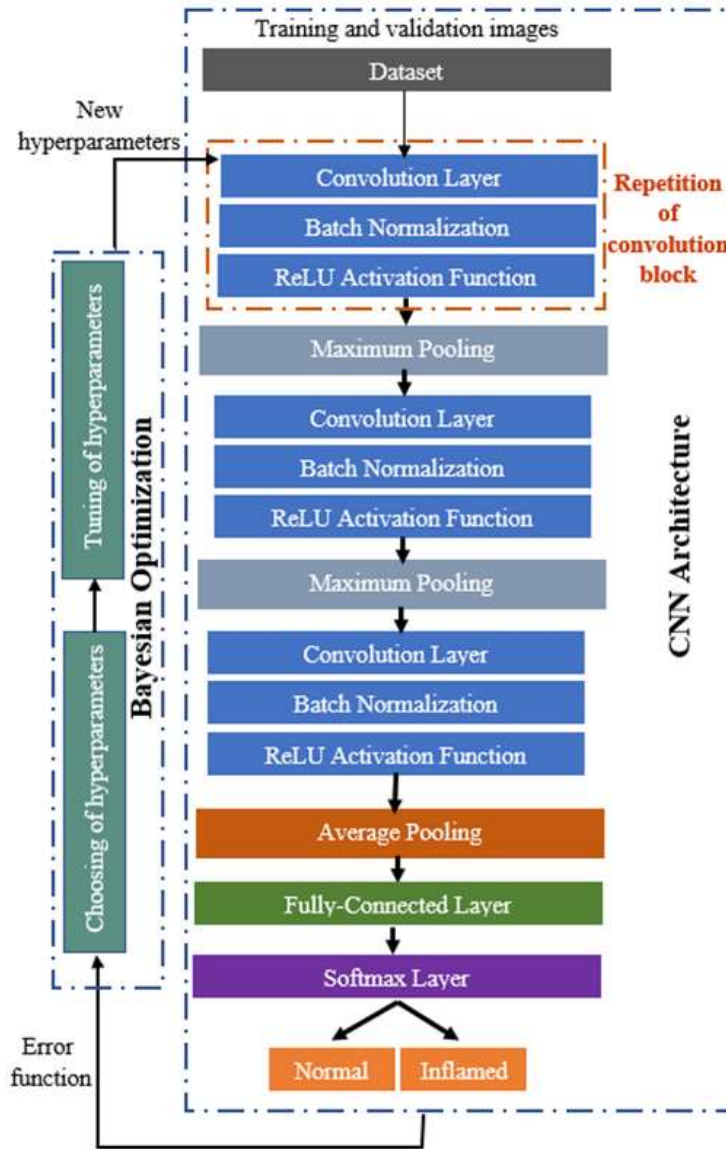

Figure 1. The proposed Bayesian optimization approach contains an initial CNN model and Bayesian optimizer.

CNN topology parameter and training hyperparameters are: *section depth* represents how many times the convolution block from which the features of the image are extracted will be created, *maximum epoch*, *initial learning rate*, *momentum* that helps accelerate gradients vectors in the right directions, *learning rate drop factor*, and *L2 regularization*. Table 1 lists the topology and training proposed hyperparameters with specific properties.

Table 1. The topology and training hyperparameters with specific properties.

Hyperparameters	Range	Function	Data type
Section depth	[1 3]	None	Integer
Max epoch	[1 10]	None	Integer
Initial learning rate	[1e-4 0.1]	Logarithmic	Real number
Momentum	[0.1 0.9]	None	Real number
Learning rate drop factor	[0 0.9]	None	Real number
L2 regularization	[0 1]	None	Real number



EXPERIMENTAL SETUP

The proposed CNN architecture

As illustrated in Figure 2, a custom CNN model was designed and the best model was obtained by optimizing with Bayesian approach. CNN architectures have feature extraction and classification parts. Convolution layers provide feature extraction of the significant characteristics of data. The classification layer categorizes data based on the characteristics extracted by the feature extraction layer. The convolution block was repeated depending on section depth and the best model was determined using Bayesian optimization.

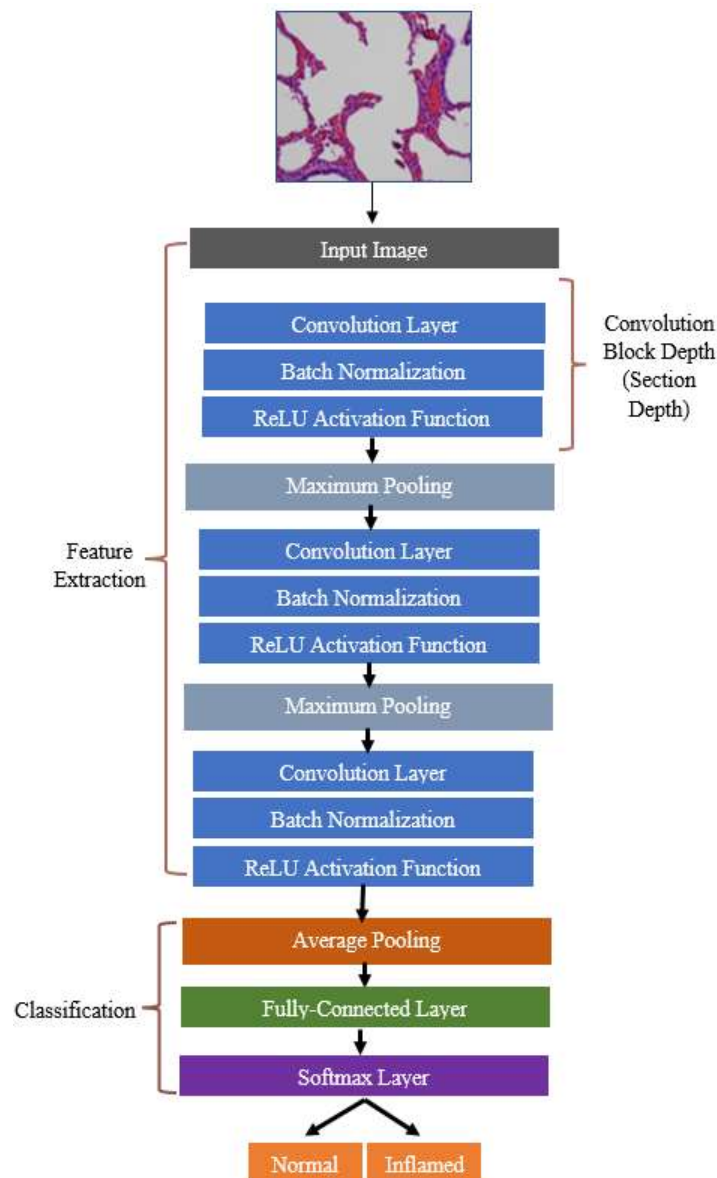

Figure 2. Proposed custom CNN model for classification.

Dataset

The proposed model was evaluated using a histopathological dataset containing mammalian kidney, lung, and spleen images provided by Animal Diagnostics Lab (ADL) (Vu et al., 2016). This dataset



consists of 335, 308, and 320 healthy and inflamed kidney, lung, and spleen images, respectively as illustrated in Figure 3. The class distributions of the datasets are as follows: 178 normal and 157 inflamed for kidney, 155 normal and 153 inflamed for lung, and 159 normal and 161 inflamed for spleen images. Reflection and translation data augmentation methods were used to increase the size of the dataset.





ADL Dataset	Sample images			
	Normal (healthy)		Inflamed	
Kidney				
Lung				
Spleen				

Figure 3. Sample images of ADL histopathological dataset.

Training of CNN model

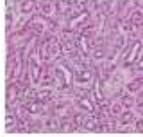
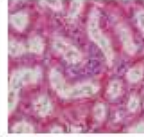
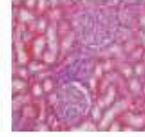
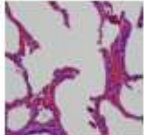
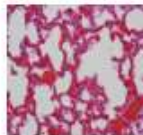
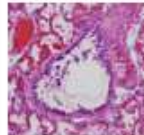
The training process of the proposed CNN model was realized in 32 minibatch size. In order to employ a learning rate schedule approach in the training of the model, the learning rate was gradually diminished. The initial learning rate and learning rate drop factor were adjusted by the Bayesian optimizer. The learning rate drop period was set to 2 epochs. In addition to this, max epoch, momentum, section depth that corresponds to convolution block repetition, and L2 regularization parameters were adjusted by the Bayesian optimizer during the tuning process. Stochastic Gradient Descent with Momentum (SGDM) optimization algorithm was used in the training process as a solver. The value intervals of the training and topology hyperparameters are listed in Table 1.

Performance metrics

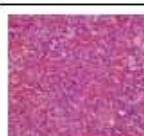
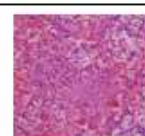
We evaluated the proposed model performance in terms of accuracy, precision, recall, and f-measure performance metrics using 5-fold cross-validation. In addition to these metrics, root mean square error (RMSE) was computed to analyze the tuning performance of Bayesian optimization.

Execution environment

This study was carried out on a device with Intel Xeon Gold 6226R processor, NVIDIA Grid RTX8000-12Q graphics card. In addition to this, the proposed CNN model was implemented on Matlab2020b using Deep Learning Toolbox.



RESULTS AND DISCUSSION

Results

The results of CNN hyperparameter optimization based on the Bayesian technique were presented in this section. During the optimization process, the maximum number of objective function evaluations was set 30 iterations. Figure 4, Figure 5, and Figure 6 illustrate a graph between the function evaluation and the minimum objective. Table 2 lists the best estimated CNN hyperparameters for the classification tasks of ADL kidney, lung, and spleen datasets.

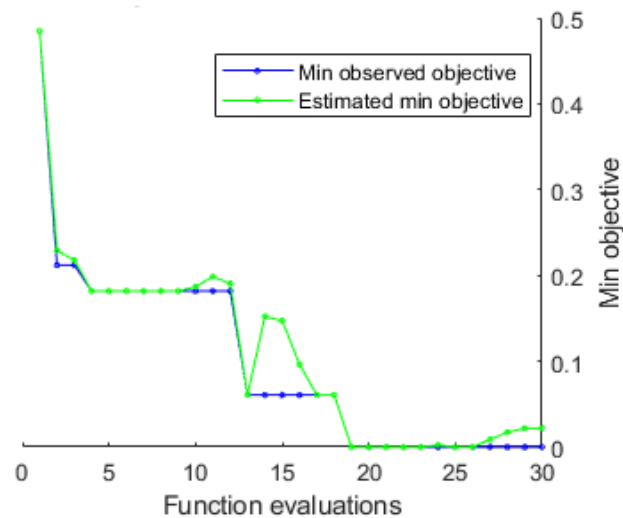

Figure 4. The number of function evaluations vs min objective during ADL kidney data classification.

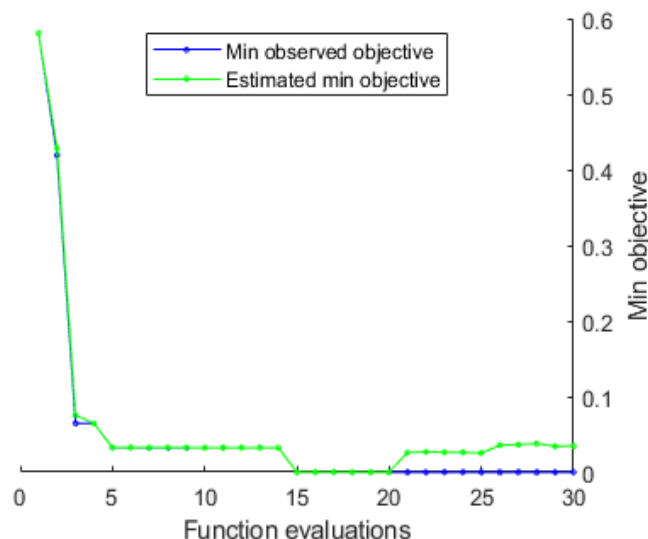

Figure 5. The number of function evaluations vs min objective during ADL lung data classification.

For the classification of the ADL kidney dataset, the best Bayesian optimized hyperparameters are: section depth=1, maximum epoch=10, initial learning rate=0.00679, momentum=0.10611, learning



rate drop factor=0.72496, and L2 regularization=0.17443. The accuracy of optimized CNN model to classify the ADL kidney dataset is 97.05%.

For the classification of the ADL lung dataset, the best Bayesian optimized hyperparameters are: section depth=2, maximum epoch=10, initial learning rate=0.00041, momentum=0.89861, learning rate drop factor=0.44072, and L2 regularization=0.89667. The accuracy of optimized CNN model to classify the ADL lung dataset is 100%.

For the classification of the ADL spleen dataset, the best Bayesian optimized hyperparameters are: section depth=1, maximum epoch=7, initial learning rate=0.01247, momentum=0.19627, learning rate drop factor=0.66510, and L2 regularization=0.66520. The accuracy of optimized CNN model to classify the ADL spleen dataset is 96.87%.

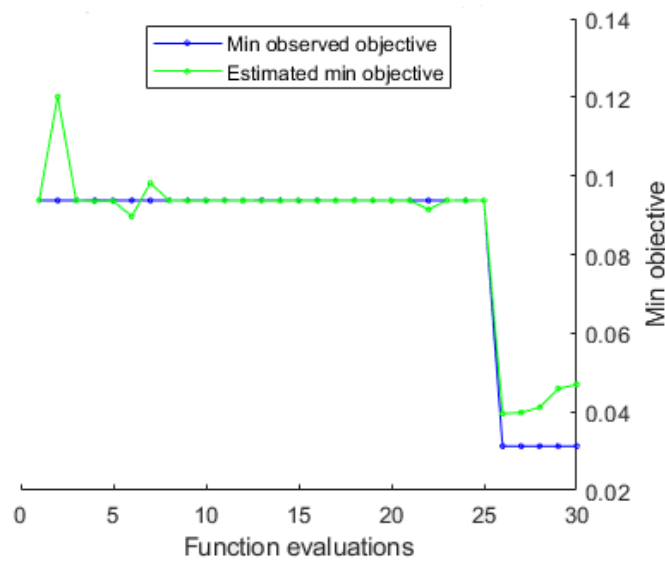

Figure 6. The number of function evaluations vs min objective during ADL spleen data classification.

Table 2. Comparison of histopathological data classification in terms of accuracy.

Datasets	ADL Kidney	ADL Lung	ADL Spleen
Section depth	1	2	1
Maximum epoch	10	10	7
Initial learning rate	0.00679	0.00041	0.01247
SGDM (momentum)	0.10611	0.89861	0.19627
Learning rate drop factor	0.72496	0.44072	0.66510
L2 regularization	0.17443	0.89667	0.66520
Accuracy (%)	97.05	100	96.87

The performance metrics of each sub-class of histopathological data for the classification task were given in Table 3. According to experimental results, ADL lung images were the class with the highest classification success, while ADL kidney was the second and ADL spleen ranked third.



Table 3. The classification performance of optimized CNN model with bayes-optimized hyperparameters.

Datasets	Measurement metrics (%)			
	Accuracy	Precision	Recall	F-measure
ADL Kidney	94.69±0.0131	95.15±0.0144	94.34±0.0140	94.74±0.0131
ADL Lung	99.35±0.0144	99.23±0.0172	99.47±0.0118	99.35±0.0145
ADL Spleen	95.62±0.0171	95.78±0.0193	95.57±0.0148	95.68±0.0166

Discussion

Classification of histopathological images is significant for medical studies to get treatment on time. This study presents an application of the Bayesian technique used for hyperparameter optimization for the classification task of the ADL histopathological dataset. CNN hyperparameters (section depth, maximum epoch, initial learning rate, momentum, learning rate drop factor, and L2 regularization) were optimized based on the Bayesian technique. The performance of the proposed model was proved by comparing various CNN configurations and hyperparameter combinations. Using optimized CNN hyperparameter, ADL lung images were the class with the highest classification success, while ADL kidney was the second and ADL spleen ranked third.

CONCLUSION

In this study, we offer an application of Bayesian optimization for the tuning of CNN topology and training hyperparameters as a classifier for the classification task of histopathological images. The hyperparameter search space was confined to the section depth, maximum epoch, initial learning rate, momentum coefficient of optimizer, learning rate drop factor, and L2 regularization. The designed custom CNN extracts features of the input images and the Bayesian optimizer modifies convolution block of the proposed CNN and training hyperparameters depending on the objective function. The experimental dataset consists of three sub-categories which are kidney, lung, and spleen histopathological images. For each sub-category, data is separated into normal and inflamed images. The classification task was experimented with for each sub-category. The findings indicate that the optimum CNN architecture and training hyperparameters calculated by Bayesian search obtained 97.97 % average accuracy depending on all histopathological dataset.

ACKNOWLEDGEMENTS

We would like to thank the Scientific Research Coordinatorship of Selcuk University for their support with the project titled “Data-Intensive and Computer Vision Research Laboratory Infrastructure Project” numbered 20301027.



REFERENCES

- Andonie, R., Florea, A.C. Weighted random search for CNN hyperparameter optimization. *International Journal of Computers Communications & Control*, 2020. 15.
- Bochinski, E., Senst, T., and Sikora, T. Hyper-parameter optimization for convolutional neural network committees based on evolutionary algorithms. 2017.
- Singh, P., Chaudhury, S., Panigrahi, B.K. Hybrid MPSO-CNN: Multi-level particle swarm optimized hyperparameters of convolutional neural network. *Swarm and Evolutionary Computation*, 2021. 63: p. 100863.
- Soon, F.C., Khaw, H.Y., Chuah, J.H., Kanesan, J. Hyper-parameters optimisation of deep CNN architecture for vehicle logo recognition. *IET Intelligent Transport Systems*, 2018.
- Soylu, K., Güzel, M., Soyly, B., Bostancı, G.E. Genetic hyperparameter optimization library development and its application on plant disease detection problem. in *2020 28th Signal Processing and Communications Applications Conference (SIU)*. 2020.
- Uyar, K., Tasdemir, Ş., Ozkan, İ.A. The analysis and optimization of CNN hyperparameters with fuzzy tree model for image classification. *Turkish Journal of Electrical Engineering and Computer Sciences*, 2022. 30(3): p. 961-977.
- Vu, T.H., Mousavi, H.S., Monga, V., Rao, G., Rao U.K.A. Histopathological image classification using discriminative feature-oriented dictionary learning. *IEEE 2016 Transactions on Medical Imaging* 2016; 35 (3): 738-751.
- Wang, Y., Wang, Y., Li, H., Cai, Z., Tang, X., Yang, Y. CNN Hyperparameter optimization based on CNN visualization and perception hash algorithm. 2020. 78-82.
- Yeh, W.C., Lin, Y.P., Liang Y.C., Lai, C.M., Gao, X.Z. Simplified swarm optimisation for the hyperparameters of a convolutional neural network. 2021.
- Yoo, Y., Hyperparameter optimization of deep neural network using univariate dynamic encoding algorithm for searches. *Knowledge-Based Systems*, 2019. 178: p. 74-83.



**PERFORMANCE EVALUATION OF PRETRAINED NETWORKS IN CLASSIFICATION
OF TREE SPECIES ON BARK TEXTURE**

Sümeyra Büşra ŞENGÜL

ORCID Code: 0000-0003-1385-0920

Kübra UYAR

ORCID Code: 0000-0001-5345-3319

İlker Ali ÖZKAN

ORCID Code: 0000-0002-5715-1040

Şakir TAŞDEMİR

ORCID Code: 0000-0002-2433-246X

Selcuk University, Technology Faculty, Department of Computer Engineering, Konya, Turkey

Abstract

Knowledge of the tree species is very important in the sustainability of forest management and in the management of the forest ecosystem. The organs of the tree, such as leaves, flowers, and bark, are used to determine the tree species. However, since it undergoes fewer changes compared to other organs, the use of bark is both more advantageous and more reliable than other organs. In this study, the BarkVN-50 dataset containing 50 classes of tree bark images was classified with pre-trained VGG16, Inception-V3, Xception, and DenseNet201 models, and the classification performance of these models was compared. The highest success was obtained from the DenseNet201 model with 95% accuracy.

Keywords: Pretrained Networks, Forest Management, Bark Texture, Bark Classification, Convolutional Neural Networks

INTRODUCTION

Forest inventories are created for carbon estimation in forestry, detection of illegal logging, controlling pests and diseases, managing forest fire hazards, and sustainable forestry (Lütjens et al., 2019). Knowing tree species in forest inventories is an important activity in sustainable forest management (Hadlich et al., 2018). When determining the tree specie, the leaves, fruits, flowers or bark of the plant are used. It is more advantageous to use the bark of the tree when defining the species compared to other organs of the plant. The bark is not affected by seasonal changes and is available year-round. Depending on age, it is thin and smooth when young and becomes hard, thickened, and cracked as it ages. It takes a regular appearance over time. Thus, the species can be known even if the tree has been chopped down. Knowing the tree species provides benefits to various fields such as taxonomy, plant research, ecological studies, sawmills, as well as forestry works (Misra et al. 2020, Remes and Haindl, 2019). Experts know the tree species in the field, such as biologists or foresters. There are different studies in the literature with Local Binary Pattern (LBP) to determine the tree species from the bark quickly and automatically without any need for the knowledge of an expert. Boudra et al. used multiscale LBP types such as Multi-resolution LBP (MResLBP), Multi-Block LBP (MBLBP), LBP-Filtering (LBPF), Multi-Scale LBP (MSLBP), and Pyramid-based LBP (PLBP). They evaluated the performance of multiscale LBP forms and basic LBP on AFF and Trunk12 datasets and observed that the performance of multiscale LBP forms was better than basic LBP (Boudra et al., 2015). Another study conducted with LBP is the study of Sulc et al. (2013). In the study, they created feature-mapped multiscale



descriptors with the merged histograms of LBPs. They used the created descriptors with SVM classification for tree bark identification on the AFF dataset and achieved a success rate of 82.5%.

With the development of technology, the increasing number of data, the existence of graphics cards with a high processing capacity that enables large-volume images to be processed, and the emergence of powerful algorithms, deep learning is frequently used especially in image analysis applications. It can process and analyze images with high accuracy, without preprocessing, with details invisible to the human eye. Deep learning methods, which are preferred in many fields such as image analysis, sound analysis, robotics, autonomous vehicles, gene analysis, cancer diagnosis, and virtual reality, are also used in forestry applications in terms of time and performance. There are different deep learning studies in the literature to determine the tree species.

Mizoguchi et al. (2017) used Lidar images instead of RGB images in their studies. They created 256x256 images from the Lidar images. They classified Japanese cedar and cypress with pre-trained AlexNet. As a result of the study, they achieved 89.8% success. In the study of Elmas (2021), a data set was created by collecting 24686 tree bark images belonging to 59 tree species from various regions in Turkey. Classified this dataset with the pre-trained convolutional neural network, AlexNet, DenseNet201, ResNet18, ResNet50, ResNet101, VGG16, and VGG19 models using the transfer learning method and achieved 99.46% success on average. Another study developed with deep learning models is the study of Carpentier et al. (2018). They created new images by cutting the tree's trunk in the data set they created by collecting more than 23000 tree bark images from 23 different tree species and classifying them with pre-trained ResNet18 and ResNet34 networks. As a result of the study, they obtained 97.70% accuracy with ResNet18 and 97.50% accuracy with ResNet50.

In the literature review, it was seen that different studies were carried out with LBP and deep learning. Studies on the determination of tree species with deep learning continue.

This study was carried out both to detect tree species from tree bark images and to observe the performance of pre-trained networks on tree textures. In the study, pre-trained VGG16, Inception-V3, Xception, and DenseNet201 models with ImageNet data were used. The BarkVN-50 dataset, which contains pictures of 50 different tree species that have not been used before in the literature, has been classified with these models.

In this study, pre-trained networks used in the study are introduced in Section 2, and information about the data set and evaluated performance criteria are given in Section 3. In the fourth section, after the environment in which the study was carried out, and the results of the study were given, these results were evaluated in the last section.

PRETRAINED MODELS

ImageNet Dataset

Convolutional neural networks are widely used for feature extraction and classification of images. Major CNN models are usually trained on the ImageNet dataset. The ImageNet dataset consists of 1000 classes, approximately 1.3 million training data, 50000 validation data, and 100000 test data (Deng et al., 2009). This data set is organized in a hierarchical structure. There are categories and subclasses.

In this study, VGG16, Inception-V3, Xception, and DenseNet201 networks pre-trained in the ImageNet dataset were used.



Pretrained Models

VGG16

The model, which was developed by Karen Simon et al. in 2014, consists of a total of 41 layers, including 13 convolution layers, 15 ReLU activation layers, five pooling layers, three fully connected layers, two dropout layers, and a softmax classification layer at the network output (Simonyan and Zisserman, 2014). The image taken in the input layer is 224x224x3 in size. It achieved an accuracy rate of 91.6% on the ImageNet dataset.

Inception-V3

The Inception-V3 model has a deep structure, unlike deep learning architectures with cascade layers. The input image of the network consisting of 315 layers is 299x299x3 in size. The model achieved 93.7% accuracy on the ImageNet dataset (Szegedy, 2016).

Xception

The Xception network, consisting of 170 layers, was developed in 2017 by Chollet et al. (2017). The input image is 299x299x3 size. While maximum pooling is used in the network, average pooling is used at its output. There is a dropout layer to prevent memorization at the network output. The model achieved an accuracy rate of 94.5% on the ImageNet dataset.

DenseNet201

In the DenseNet module, each layer is connected feed-forward to the next layer. The information from the previous layer is combined with the next layers (Huang, 2017).

EXPERIMENTAL SETUP

BarkVN-50 Dataset

The BarkVN-50 dataset consists of bark images of 50 tree species. Images are color images of 303x404 pixels. There are a total of 5578 images in the data set (Truong Hoang, 2020). Sample images of the data set are presented in Fig.1. No previous study with this dataset has been found in the literature.



Figure 1. BarkVN-50 Dataset Image Samples.

Performance Metrics

The confusion matrix is used to evaluate the classification model's success. There are four parameters in the confusion matrix: true positive, false positive, true negative, and false negative. Table 1 contains confusion matrix and explanations. Accuracy, precision, recall, and f1-score values—whose explanations and formulas are provided in Table 2—are used to evaluate performance in binary classification based on the confusion matrix. The macro average and micro average of the metrics listed in Table 2 are used to evaluate performance in multiple classification problems (Sokolova and Lapalme, 2009). In this study, macro-averages of performance metrics were used. Table 3 shows the formulas for the metrics that were used.

Table 1. Confusion Matrix and Explanations

	Predicted Negative	Predicted Positive
Actual Negative	TN – The predicted value is negative and it is negative.	FP- The predicted value is positive but it is false.
Actual Positive	FN – The predicted value is negative but it is positive.	TP – The predicted value is positive but it is true.

**Table 2.** Metrics and formulas for binary classification

Metric	Formula
Accuracy	$\Sigma_{i=1}^l = \frac{tp_i + tn_i}{tp_i + fn_i + fp_i + tn_i}$
Precision (P_M)	$\Sigma_{i=1}^l = \frac{tp_i}{tp_i + fp_i}$
Recall (R_M)	$\Sigma_{i=1}^l = \frac{tp_i}{tp_i + fn_i}$
F1-Score (F_M)	$\frac{(\beta^2 + 1)P_M R_M}{\beta^2 P_M + R_M}$

Table 3. Metrics and formulas for multi classification (Macro-Average) (Sokolova and Lapalme, 2009)

Metric	Formula	
Accuracy	$(TP+TN)/(TP+TN+FP+FN)$	It is the ratio of correctly predicted samples to total samples.
Precision	$TP/(TP+FP)$	It is the ratio of correctly predicted positive samples to positively predicted samples.
Recall	$TP/(TP+FN)$	It is the ratio of correctly predicted positive samples to actual positives.
f1-score	$2*(Precision*Recall)/(Precision+Recall)$	It is the harmonic mean of the recall and precision values.

RESULTS AND DISCUSSIONS

This study was carried out on a device with Python 3.8, Tensorflow2.3, CUDA10.1.243, cuDNN7.6.5 technologies, Intel Xeon Gold 6226R processor, Nvidia Grid RTX8000-12Q graphics card.

The images in the BarkVN-50 dataset were rescaled according to the input image size of the network to be trained, as shown in Table 4.

Table 4. CNN Architecture Input Image Size

Models	Input Image
VGG16	224x224x3
Inception v3	299x299x3
Xception	299x299x3
DenseNet201	224x224x3

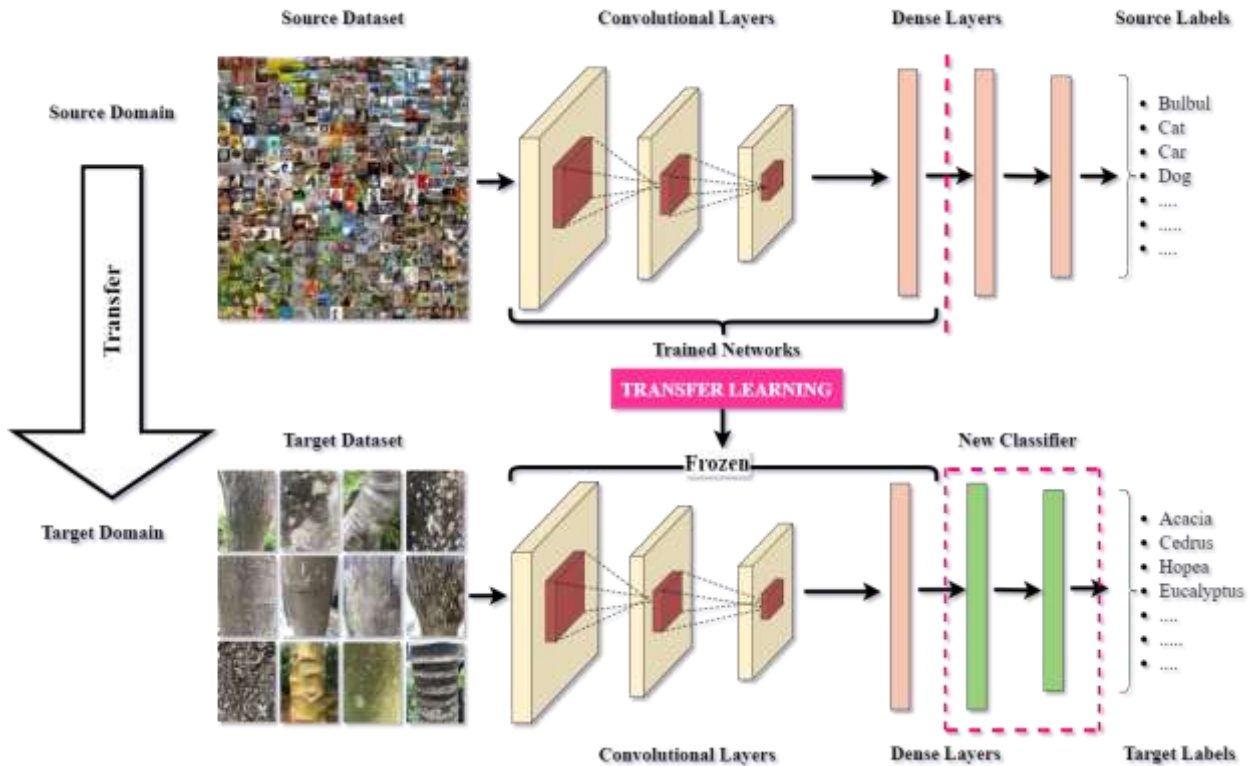

Figure 2. Transfer Learning Block Diagram

The data is divided into 70% training data and 30% test data. In the study, in order to use the weights of VGG16, Inception-V3, Xception, and DenseNet201 models obtained as a result of training on ImageNet data, the layers before classification were frozen, and since the number of classes in the BarkVN-50 dataset was 50, the number of classes in the ImageNet dataset was changed from 1000. The modified layers are trained. This process is called transfer learning. The transfer learning block diagram is shown in Fig.2. The training results of the pre-trained models are shown in Table 5.

Table 5. Performance Metrics of Models

Models	Accuracy	Precision	Recall	F1-Score
VGG16	0.891	0.894	0.878	0.876
Inception v3	0.943	0.941	0.937	0.937
Xception	0.945	0.939	0.938	0.937
DenseNet201	0.954	0.951	0.948	0.949

CONCLUSION

It is important to know the tree specie in various fields such as forestry activities, ecological studies, taxonomy, plant research, and sawmills. The tree specie is most reliably determined by examining the bark, as it is always accessible throughout the year and is less affected by environmental conditions than other parts of the tree.

This study classified tree bark images of 50 species with pre-trained VGG16, Inception-V3,



Xception and DenseNet201 networks.

When the training results were examined, it was seen that there was not much difference between the results of the Inception-V3, Xception, and DenseNet201 models. However, VGG16 gave lower results compared to these models. The highest success was obtained from the DenseNet201 model with 95%. With this previously untested data set, it is seen that pre-trained networks are quite successful in classifying detailed images.

When the results were compared with the literature, it was seen that close results [8,9] were obtained on different data sets, but it was more successful than AlexNet (Mizoguchi et al., 2017).

When the studies on tree texture in the literature are examined, it is thought that success can be improved with practices such as increasing the number of data by combining different data sets, combining transfer learning methods, and machine learning methods.

ACKNOWLEDGEMENT

We would like to thank the Scientific Research Coordinatorship of Selcuk University for their support with the project titled “Data-Intensive and Computer Vision Research Laboratory Infrastructure Project” numbered 20301027.

REFERENCES

- Boudra S., Yahiaoui I. and Behloul A., “A Comparison of Multiscale Local Binary Pattern Variants For Bark Image Retrieval”, 16th International Conference on Advanced Concepts for Intelligent Vision Systems (ACIVS), Catania-Italy, pp. 764–775, 2015, doi: 10.1007/978-3-319-25903-1_66.
- Carpentier M. et al., “Tree Species Identification From Bark Images Using Convolutional Neural Networks”, 2018 IEEE/RSJ International Conference on Intelligent Robots and Systems (IROS). pp. 1075–1081, 2018, doi: 10.1109/IROS.2018.8593514.
- Chollet F., “Xception: Deep Learning With Depthwise Separable Convolutions”, CVPR, pp. 1251-1258, 2017.
- Deng J. et al., “ImageNet: A Large-Scale Hierarchical Image Database”, CVPR 2009, 2009, doi:10.1109/CVPR.2009.5206848.
- Elmas B., “Identifying Species Of Trees Through Bark Images By Convolutional Neural Networks With Transfer Learning Method”, Journal of the Faculty of Engineering and Architecture of Gazi University, 36 (3), 1253-1270, 2021, doi: 10.17341/gazimmfd.689038.
- Hadlich H.L. et al., “Recognizing Amazonian Tree Species in The Field Using Bark Tissues Spectra”, Ecol. Manag., 427, pp. 296–304, 2018, doi: 10.1016/j.foreco.2018.06.002.
- Huang G., “Densely Connected Convolutional Networks”, CVPR, pp. 4700-4708, 2017.
- Lütjens B., Liebenwein L., Kramer K., 2019, “Machine Learning-Based Estimation of Forest Carbon Stocks to Increase Transparency of Forest Preservation Efforts”, NeurIPS 2019 Workshop on Tackling Climate Change with Machine Learning, <https://www.climatechange.ai/papers/neurips2019/44>
- Misra D., Crispim-Junior C. and Tougne L., “Patch-Based CNN Evaluation for Bark Classification,” Lect. Notes Comput. Sci. (including Subser. Lect. Notes Artif. Intell. Lect. Notes Bioinformatics), vol. 12540 LNCS, pp. 197–212, 2020, doi: 10.1007/978-3-030-65414-6_15.
- Mizoguchi T., et. al., “Lidar-Based Individual Tree Speciesclassification Using Convolutional Neural Network”, In Video Metrics, Range Imaging, And Applications XIV; International Society For Optics And Photonics: Bellingham, WA, USA, vol. 10332,



2017,doi:10.1117/12.2270123.

Remeš V. and Haindl M., “Bark Recognition Using Novel Rotationally Invariant Multispectral Textural Features”, *Pattern Recognit Lett*, 125, pp. 612–617, 2019, doi: 10.1016/j.patrec.2019.06.027.

Simonyan K. and Zisserman A., “Very Deep Convolutional Net-Works For Large-Scale Image Recognition,”, 2014, doi: doi.org/10.48550/arXiv.1409.1556

Sokolova M. and Lapalme G., “A systematic analysis of performance measures for classification tasks”, *Information Processing and Management*, vol. 45, 427–437, 2009, doi: 10.1016/j.ipm.2009.03.002.

Sulc M. and Matas J., “Kernel-Mapped Histograms of Multi-Scale LBPs For Tree Bark Recognition”, 28th International Conference of Image and Vision Computing New Zealand (IVCNZ), Wellington-New Zealand, pp. 82–87, 2013, 10.1109/IVCNZ.2013.6726996.

Szegedy C. et. al., “Rethinking The Inception Architecture For Computer Vision”, *CVPR*, pp.2818-2826, 2016.

Truong Hoang, Vinh (2020), “BarkVN-50”, *Mendeley Data*, V1, doi: 10.17632/gbt4tdmtn.1.



KENTSEL AÇIK VE YEŞİL ALANLARIN KENT EKONOMİSİNE KATKISININ BELİRLENMESİNDE FARKLI YÖNTEMLERİN KULLANILMASI

Rukiye Duygu Çay

Hatice Kıran Çakır

Trakya University, Faculty of Architecture, Department of Landscape Architecture, Edirne, Turkey
Trakya University, Faculty of Architecture, Department of Architecture, Edirne, Turkey

Özet

Açık ve yeşil alanlar, insan ile doğa arasında ilişki kurmada, kentsel yaşam kalitesinin artırılmasında, kentin tanınırlığında ve prestij sahibi olmasında önemli görevler üstlenmektedirler. Bununla birlikte bu alanlar kentin turizm performansını da etkileyen bir çekim kaynağıdır. Özellikle turizm potansiyeline sahip olan kentlerde, görsel peyzaj kalitesi yüksek olan kentsel açık alanlar kendi başlarına önemli turistik cazibe unsuru olabilmektedir. Bu alanlar, kente estetik ve sosyal yönden faydalar üretmekte ve bu doğrultuda kent ekonomisinin geliştirilmesinde de etkin rol oynamaktadırlar. Rekreasyon değerine sahip bu alanların sürdürülebilir olmasını sağlamak için çeşitli yöntemler doğrultusunda planlama çalışmaları geliştirilmektedir. Bu çalışmalar ve yönetim modelleri; alanın niteliğine, sağlayacağı ekonomik değere ve kullanıcı kitlesine göre oluşturulmaktadır. Bu alanların özellikle ekonomik değerlerinin belirlenmesinde çeşitli yöntemler kullanılmaktadır. Bu çalışmada ilgili yöntemlerden Koşullu Değerleme Yöntemi (KDY), Seyahat Maliyet Yöntemi (SMY) ve Hedonik Fiyat Yöntemi (HFY) incelenmiş ve bunların içerisinde kullanılacak en uygun yöntem belirlenmeye çalışılmıştır.

Anahtar Kelimeler: Ekonomik değer, Koşullu Değerleme Yöntemi, Seyahat Maliyet Yöntemi, Hedonik Fiyat Yöntemi

USING DIFFERENT METHODS IN DETERMINING THE CONTRIBUTION OF OPEN AND GREEN SPACES TO THE URBAN ECONOMY

Abstract

Open and green areas undertake important tasks in establishing a relationship between man and nature, improving the quality of urban life, recognizing the city and having prestige. Also, these areas are a source of attraction that affects the city's tourism performance. Especially in cities with tourism potential, urban open spaces with high visual landscape quality can be an important element of touristic attraction on their own. These areas produce aesthetics and social benefits to the city and accordingly play an active role in the development of the urban economy. Planning studies are being developed in line with various methods in order to ensure to sustainability of these areas which has recreation value. These studies and management models; is formed according to the nature of the field, the economic value it will provide and the user audience. Various methods are used to determine the economic values of these areas. In this study, the Contingent Valuation Method (CVM), Travel Cost Method (TCM) and Hedonic Price Method (HPM) of the related methods were examined and the most appropriate method is aimed to determine.



Keywords: Economic value, Conditional Valuation Method, Travel Cost Method, Hedonic Price Method

1. GİRİŞ

Kentsel açık ve yeşil alanlar kentler için ekolojik, kültürel, sosyal ve ekonomik açıdan önemli katkılar sunan kamusal mekanlardır. Bu alanlar kentler için hava kalitesini arttıran, rekreasyon olanağı sağlayan yararları ile yaşam kalitesi ve kent ekonomisini geliştirmektedir (Çay & Karakaya Aytin, 2020). Bu alanlar yalnızca kentliler için yalnızca sosyal fiziksel ve psikolojik yararlar sağlamakla kalmaz, içerdiği yeşil alan kitlesi ile doğal çevreyi korur, kentin farklı yapıları arasında tampon görevi görür ve kent içindeki binalara değer kazandırır (Öztürk, 2004).

Açık ve yeşil alanların ekonomik değerlerinin tespit edilerek bir değer biçilmesi bu kaynakların bilinçli kullanımının sağlanmasını ve gelecek nesillerin bu kaynaklardan yararlanabilmelerini sağlamanın bir yoludur. Bireyler, aynı zamanda ekonominin ana teması olan sosyoekonomik yapılar yönünde tüketecekleri veya vazgeçecekleri arasında bir seçim yapmak durumundadır. Bu seçimdeki en rasyonel davranış, sınırlı kaynakların tüketimi için en fazla memnuniyeti sağlayan tercihlerin doğru sıralanmasıdır. Altunkasa (2008) ekonominin bu işlevini doğal ve çevresel meselelere uyarılmanın beklenen yararı, sonunda çevrenin ve doğanın korunması ve iyileştirilmesi ile çevrenin korunması ve ekonomik politikalarda iyileştirmeyi dahil ederek ortaya çıkacak sosyal refah olduğunu belirtmiştir (Çay & Taşlı, 2020).

Kentsel açık ve yeşil alanların ekonomik değerinin tespit edilmesi doğrudan ve dolaylı kullanım olmak üzere iki şekilde yapılmaktadır. Bu yöntemler ile kamusal alanların ekonomik değerlerinin piyasada alınıp satılan diğer mallar üzerinden ölçülmesi için uygulanmaktadır (Alkay & Ocakçı, 2011).

2. KENTSEL AÇIK VE YEŞİL ALANLARIN EKONOMİK DEĞERİNİ ÖLÇME YÖNTEMLERİ

Günümüzde çevre ve ekonomi kavramları birbiri ile oldukça ilişkili iki kavramdır. Ekonomi çevrenin nitelikleri ile ilişkiliyken, çevre de ekonominin belirli şartlar altında biçimlenmesinden etkilenir (Yaman ve Muşmul, 2018). Bir çevrenin kalite değeri, o alanın temiz havaya, korunmuş flora ve fauna alanlarına sahip olması ve kent karmaşasından uzak uzak bir alan sunmasıdır (Taşcıoğlu vd., 2015). Bu alanların ekonomik faydalarını doğrudan tespit etmek mümkün değildir. Kentsel açık yeşil alanların kamu mevduatı olarak görülmesi sebebiyle planlama ve uygulama yönetimindeki bireyler sürekli olarak bu alanların yapımı, onarımı, yönetimi ve sürdürülebilir olmasından doğan maliyetlerin, toplumun rahatlığının arttırılmasına yönelik alınan kararlar ile desteklenmesi sonucu uzun süreçte gösterilecek yararın değer olup olmaması konusuna cevap aramaktadırlar (Alkay ve Ocakçı, 2011).

Günümüzde kentlerde betonlaşmanın artması ve bunun sonucu olarak kentsel yeşil alanların azalmasıyla, kent ekonomisi adına katkı sunan alanlar olması dolayısıyla belirlenen bu alanlara belirli fiyat değerleri biçilmesi gerekmektedir. Kentsel açık yeşil alanların ekonomik açıdan nasıl ölçülebileceği ile ilgili pek çok çalışma yapılmakta olup, çeşitli yöntemler geliştirilmiştir (Alkan ve Uslu, 2016).

Rekreasyon potansiyeline sahip kentsel açık ve yeşil alanların sürdürülebilir kullanımının sağlanabilmesi için ayrılan kaynaklar kısıtlı olabilmektedir. Son yıllarda yapılan çalışmalar, topluma katkı sağlayan bu alanların ekonomik değerinin belirlenmesinin önem kazandığını göstermektedir (Güven Kaya ve Özyürek, 2015; Pirikiya vd., 2016) ve bu amaç doğrultusunda bir takım yöntemler geliştirilmiştir. Bu yöntemler, doğrudan ölçüm yöntemlerinden olan Koşulları



Değerleme Yöntemi (KDY) ve dolaylı ölçüm yöntemlerinden Seyahat Maliyeti Yöntemi (SMY) ve Hedonik Fiyatlandırma yöntemidir (HFY) (Çay vd., 2020; Mitchell ve Carson, 1989).

2.1. Doğrudan Ölçüm Yöntemleri

Doğrudan kullanım değeri, doğal kaynakların doğrudan kullanımı sonucunda elde edilen fayda değeri şeklinde tanımlanmaktadır. Bu değer rekreasyon alanlarına giriş ücreti gibi ticari olan değerler yanında alanın kullanımından doğan fayda gibi ticari değeri olmayan değerleri de içermektedir (Uslu, 2002). Doğrudan kullanım değerini belirlemede en yaygın kullanılan yöntemlerden biri Koşullu Değerleme Yöntemidir.

2.1.1. Koşullu Değerleme Yöntemi

Koşullu Değerleme Yöntemi (KDY), kamusal kaynakların ekonomik anlamda değerlerinin belirlenmesi için yararlanılan bir çeşit anket yöntemidir (Yılmaz ve Koç, 2018). Bu yöntem ilk olarak Davis (1964) tarafından kullanılmıştır. Bu yöntemi, ormanların sunmuş olduğu olanakların ve geliştirilen faaliyetlerin hizmet değerini hesaplama yöntemi olarak geliştirmiştir. KDY zaman içerisinde, kent ve çevresinin sahip olduğu değerlerin ekonomik değerinin tespit edilmesini sağlamak amacıyla geliştirilmiştir (Yurdakul, 2021).

KDY yalnızca kentsel açık ve yeşil alanların rekreasyon değerini ölçmek için değil, aynı zamanda kullanım değeri olmayan varlıkların da değerini ölçmek için kullanılan tek yöntemdir (Loomis vd., 2009). Bu yöntemde kullanıcılardan belirli bir hizmet veya mal için ne kadarlık bir ödeme yapmak istediklerini tahmin etmeleri istenir. Bu hizmet veya malın ekonomik değeri, her bir katılımcının belirttiği ödeme isteklerinin toplanmasıyla elde edilir (Ajzen vd., 1996). Ortaya çıkan ödeme istekliği değerleri, kuramsal pazarların özelliklerine bağlı olduğu için bu yöntem koşullu değerlendirme olarak adlandırılmaktadır (Kalfa, 2018). KDY'nin amacı, mal ve hizmetlerin kalitesinde ve miktarında meydana gelecek değişimlere karşı bireylerin ödeme isteklerini tahmin etmek ve bunlar üzerindeki etkisi bulunan değişkenleri tespit etmektir (Haab ve McConnell, 2002).

Koşullu değerlendirme yöntemi beş aşamada uygulanmaktadır. Bunlar; kurgusal bir pazarın oluşturulması, verilerin toplanması ve değerlendirilmesi, kullanıcıların ödeme istekliliğinin tahmin edilmesi, ödeme eğilimini oluşturan değer fonksiyonunun tahmin edilmesi ve toplam değer hesaplanması şeklindedir (Gündoğmuş ve Kalfa, 2016; Hanley vd., 2016).

Alkay ve Ocakçı (2011) yöntem kapsamında alınan varsayımsal yanıtların eleştiri konusu olduğunu ve bunun dışında karşılaşılan diğer sorunların, cevapların gerçek ödemenin gönüllü değerlendirilmesini yansıtmaması, varsayımsal olarak belirlenen eşik değerleri ve kurgusal sorunlar olduğunu belirtmiştir.

2.2. Dolaylı Ölçüm Yöntemleri

Kentsel açık ve yeşil alanlar plansız kentleşme ve nüfus artışı gibi nedenlerle tehdit altındadır. Bu alanların devamlılığının sağlanması için arz ve talep ilişkisinin belirlenmesi önem kazanmaktadır (Çay vd., 2020). Dolaylı kullanım değerlerinin en önemli özelliği, insanların doğal kaynakların faydalarından yararlanmayacağını bilmelerine rağmen yine de bu tür kaynakların varlığından memnuniyet duymasıdır (Kalfa, 2018). Dolaylı kullanım değerini belirlemede en yaygın kullanılan yöntemler arasında Hedonik Fiyatlandırma Yöntemi ve Seyahat Maliyet Yöntemi sayılabilir.

2.2.1. Hedonik Fiyatlandırma Yöntemi

Hedonik fiyatlandırma yöntemi (HFY), çevrenin niteliklerinin değişmesiyle beraber çeşitli hizmetlere yapılan ödeme istekliliğini dolaylı olarak ölçen bir analiz yöntemidir. Bu yöntem, gayrimenkul fiyatları ile çevre kalitesi arasındaki ilişkiyi ortaya koymaktadır (Kalfa, 2018).



HFY, satışa sunulan çeşitli malların özellikleri ile bunların ederi arasındaki bağlantıyı ve bu ürünlerin diğerlerinden ayırmaya yardımcı olan niteliklerinin görünürdeki değerini hesaplama yöntemidir (Yayar ve Karaca, 2014). Hedonik fiyat modeli aşağıdaki fonksiyonla ifade edilebilir (G Kaya, 2002);

$$P_e = f (Y, K, U, \text{Ç}) \quad (1)$$

Burada P_e bağımlı değişken olan konut fiyatlarını, Y konutların yapısal niteliklerini, K komşuluk niteliklerini, U ulaşılabilirlik niteliklerini ve Ç çevresel nitelikleri ifade etmektedir.

Bu yöntem dört aşamada gerçekleştirilir. Bu aşamalar; problemin tespit edilmesi, verilerin oluşturulması, fonksiyonun belirlenmesi ve ekonomik değer hesaplanmasından oluşur (Güven Kaya ve Özyürek, 2015). Bu yöntemde karşılaşılan sorunlar, veri toplama işleminin maliyetli ve sınırlı olması, ihmal edilmiş olabilecek değişkenler ve oluşturulan modelin yetersiz kalması şeklinde özetlenebilir (Alkay ve Ocakçı, 2011).

HDY'nin avantajları arasında kullanılan değişkenlerin her birinin konut fiyatları üzerindeki etkisinin belirlenmesi, bu yöntemin üretim tercihlerini şekillendirmesi, hesaplama yapılırken gerçek ödeme istekliliği değerinin dikkate alınması ve konut piyasasının büyük bölümünü analiz etmeye olanak tanınması olarak sayılabilir (Baranzini vd., 2008; A. Kaya, 2012). Sahip olduğu tüm bu avantajlara rağmen bu yöntemin güvenilir sonuçlar verebilmesi için çok sayıda değişkene ve veriye ihtiyaç duyulması, değişken seçiminde hassas davranılması gerekliliği aksi takdirde model tanımlama hatalarının ortaya çıkması ve çalışma alanının kamusal veya kırsal arazileri içermesi durumunda kullanıcı faydalarını tam olarak yansıtamaması gibi sorunları bulunmaktadır (Arıkan, 2008; Kalfa, 2018).

2.2.2. Seyahat-Maliyet Yöntemi

Seyahat Maliyet Yöntemi (SMY) kentsel açık ve yeşil alanların rekreasyon değerinin belirlenmesinde kullanılan bir yöntemdir. Bireylerin kentlerde yararlandığı çevresel değer ve hizmetlere karşın ödemeye razı oldukları değer olarak ifade edilebilmektedir. Bu yöntem kullanıcıların alana ulaşmak için harcadığı ve alandaki hizmetler için ödemeyi kabul ettiği para miktarını belirtmektedir. SMY ile model ile çeşitli değişkenler belirlenerek ve tüketici rantı hesaplanmaktadır (Limaei vd., 2014). Bu değişkenler ziyaret sayısı, ulaşım maliyeti, alana giriş ücretleri ve ulaşım için harcanan toplam zaman olarak tanımlanabilmektedir (Bertram ve Larondelle, 2017).

Seyahat maliyeti belirlenirken ziyaret sıklığı ve maliyetler belirlenmektedir. Maliyet dışında ziyaret sıklığını etkileyen en önemli faktör rekreasyon alanının kalitesidir. Bunun yanında kullanıcıların gelir düzeyi, yaş, cinsiyet, eğitim düzeyi, meslek bilgileri de ziyaret sıklığını etkileyen diğer faktörlerdir (Dewanta, 2010; Fauzi, 2004; Pirikiya vd., 2016; Solikin vd., 2019). Bu faktörler matematiksel olarak şu şekilde tanımlanmaktadır;

$$V_i = f (S_i, Y_i, G_i, E_i) \quad (2)$$

Bu denklemde S_i seyahat maliyetini, Y_i kullanıcıların yaş ortalamasını, G_i kullanıcıların gelir düzeyini, E_i alanda gerçekleştirilen etkinlikler için yapılan harcamayı belirtmektedir (Çay vd., 2020)

SMY bireysel ve bölgesel olmak üzere iki çeşitte uygulanabilir. Bireysel SMY çeşitli değişkenlere bağlı olarak bireylerin belirli bir sürede alana yaptığı ziyaret sayısı olarak ifade edilmektedir. Bölgesel SMY ise belirli bir bölgede ikamet eden kullanıcıların bir alanı ziyaretlerinin, bu bölgenin nüfusuna bölünmesiyle ortaya çıkan oran olarak tanımlanır (Ortaçşeme vd., 1999).

Kullanıcıların seyahat maliyeti ve süresi, sosyo-ekonomik durumları ile ilgili verdikleri yanıtların güvenilirliği, rekreasyon potansiyelinin tam olarak ortaya konamaması, modelin oluşturulması ve



tahmin problemleri bu yönteminin uygulanmasında karşılaşılan genel sorunları oluşturmaktadır (Alkay ve Ocakçı, 2011).

3. SONUÇ

Günümüzde kentler ve kentlerin yakın çevrelerinde doğal alanlar yeterince korunamamakta, yeşil alan miktarı her geçen yıl azalmaktadır. Kullanıcıların belirli bir ekonomik değeri olmayan bu yapıların ortaya koyduğu yararların farkında olmamaları, bunların bilinçsiz bir şekilde kullanımına neden olmaktadır. Ancak bu yapıların ekonomik değerlerinin tespit edilmesi ile sağladıkları faydalar belirlenerek, bu kaynakların daha bilinçli bir şekilde ve korunarak kullanımı ön plana çıkacaktır.

Konusu üretimden tüketime kadar olan tüm süreçleri kapsayan ekonomi, bireylerin doğal kaynakları da kullanırken belirli seçimler yapmasını teşvik etmektedir. Burada önemli olan, sınırlı olan kaynakların tüketiminin belirli düzeylerde tutularak doğanın korunması ile oluşacak toplumsal kazancın belirlenmesidir.

Kentsel açık ve yeşil alanların ekonomik değerini belirlemek amacıyla uygulanan HFY ve KDY rekreasyon alanlarının ekonomik değerinin kullanım ve kullanım dışı değerleri ile, SMY ise bu ekonomik değerin yalnızca kullanım değeri ile belirlenmesini sağlamaktadır.

HDY ve KDY ile ekonomik değer hesaplanırken alandaki olumlu ve olumsuz değişimleri, SMY ise yalnızca olumlu değişimleri baz almaktadır.

HFY kamusal mekanlarda kalite yaşam indeksi oluşturmayı mümkün kılmaktadır. KDY ile kamusal alanların iyileştirilme çalışmaları için yatırım değerleri tespit edilebilmektedir. SMY ise rekreasyon alanlarının ekonomik değerinin belirlenmesi ve benzer alanların değerlerinin karşılaştırılması için kullanılmaktadır (Alkay ve Ocakçı, 2011).

KAYNAKLAR

- Ajzen, I., Brown, T. C. ve Rosenthal, L. H. (1996). Information bias in contingent valuation: effects of personal relevance, quality of information, and motivational orientation. *Journal of environmental economics and management*, 30(1), 43-57.
- Alkan, Y. ve Uslu, C. (2016). Aktif yeşil alanların konut fiyatları üzerine etkisinin araştırılması: Mersin ili Yenişehir ilçesi örneği. *İnönü Üniversitesi Sanat ve Tasarım Dergisi*, 6(13).
- Alkay, E. ve Ocakçı, M. (2011). Kentsel yeşil alanların ekonomik değerlerinin ölçülmesinde kullanılabilir yöntemlerin irdelenmesi. *İTÜDERGİSİ/a*, 2(1).
- Arıkan, F. E. (2008). *Ev kiralarını etkileyen faktörlerin hedonik fiyat yöntemi ile belirlenmesi*. (Doktora Tezi).
- Baranzini, A., Ramirez, J., Schaerer, C. ve Thalmann, P. (2008). *Hedonic methods in housing markets: Pricing environmental amenities and segregation*: Springer Science & Business Media.
- Bertram, C. ve Larondelle, N. (2017). Going to the woods is going home: Recreational benefits of a larger urban forest site—A travel cost analysis for Berlin, Germany. *Ecological economics*, 132, 255-263. doi:<http://dx.doi.org/10.1016/j.ecolecon.2016.10.017>
- Çay, R. D., Aşlıoğlu, F. ve Konyalı Dereli, C. (2020). Edirne Kent Ormanının Rekreasyon Değerinin Seyahat Maliyeti Yöntemi ile Belirlenmesi. *Akademia Doğa ve İnsan Bilimleri Dergisi*, 6(1), 93-106.
- Davis, R. K. (1964). *The value of big game hunting in a private forest*. Paper presented at the Transactions of the Twenty-Ninth North American Wildlife Conference.



- Dewanta, A. S. (2010). Valuation of Mount Merapi National Park: A travel cost analysis. *Economic Journal of Emerging Markets*, 2(1), 79-88. doi:<https://doi.org/10.20885/ejem.v2i1.2386>
- Fauzi, A. (2004). *Ekonomi sumber daya alam dan lingkungan: Teori dan aplikasi*: Gramedia Pustaka Utama.
- Gündoğmuş, M. E. ve Kalfa, V. R. (2016). Piyasa Değeri Olmayan Varlıkların Ekonomik Değerinin Belirlenmesi. *Journal of Life Economics*, 3(4), 177-200. doi:10.15637/jlecon.163
- Haab, T. C. ve McConnell, K. E. (2002). *Valuing environmental and natural resources: the econometrics of non-market valuation*: Edward Elgar Publishing.
- Hanley, N., Shogren, J. F. ve White, B. (2016). *Environmental economics: in theory and practice*: Macmillan international higher education.
- Kalfa, V. R. (2018). *Doğal kaynakların rekreasyonel amaçlı kullanımının ekonomik değerinin belirlenmesi: Pamukkale Örenyeri örneği*. (Doktora Tezi).
- Kaya, A. (2012). *Türkiye’de konut fiyatlarını etkileyen faktörlerin hedonik fiyat modeli ile belirlenmesi*. (Uzmanlık Yeterlilik Tezi).
- Kaya, G. (2002). *Pazarı olmayan ürünler çerçevesinde orman kaynaklarının değerinin belirlenmesi*. (Doktora Tezi).
- Kaya, G. ve Özyürek, E. (2015). Kent ormanı anlayışıyla ODTÜ Ormanı manzarası için ekonomik değer tahmin edilmesi. *Ormanlık Araştırma Dergisi*, 1(2 A), 15-28. doi:<http://dx.doi.org/10.17568/oad.69943>
- Limaei, S. M., Ghesmati, H., Rashidi, R. ve Yamini, N. (2014). Economic evaluation of natural forest park using the travel cost method (case study; Masouleh forest park, north of Iran). *Journal of Forest Science*, 60(6), 254-261. doi:<https://doi.org/10.17221/84/2013-JFS>
- Loomis, J., Tadjion, O., Watson, P., Wilson, J., Davies, S. ve Thilmany, D. (2009). A hybrid individual—zonal travel cost model for estimating the consumer surplus of golfing in Colorado. *Journal of Sports Economics*, 10(2), 155-167.
- Mitchell, R. C. ve Carson, R. T. (1989). *Using surveys to value public goods: the contingent valuation method*. Washington, USA: Resources for the Future.
- Ortaçesme, V., Özkan, B., Karagüzel, O., Atik, M. ve Akpınar, M. (1999). *Kurşunlu Şelalesi Tabiat Parkının Ekonomik Değerinin Saptanması*. Retrieved from TÜBİTAK Proje Raporu No: TARP-2152.:
- Pirikiya, M., Amirnejad, H., Oladi, J. ve Solout, K. A. (2016). Determining the recreational value of forest park by travel cost method and defining its effective factors. *Journal of Forest Science*, 62(9), 399-406. doi:<https://doi.org/10.17221/12/2016-JFS>
- Solikin, A., Rahman, R. A., Saefrudin, E., Suboh, N., Zahari, N. H. ve Wahyudi, E. (2019). Forest Valuation Using Travel Cost Method (TCM): Cases of Pahang National Park and Srengseng Jakarta Urban Forest. *PLANNING MALAYSIA*, 17(9).
- Taşçıoğlu, S., Günaydın, A. S., Yücekaya, M. ve Altunkasa, F. (2015). Yeşil Alan Donatısının Konut Fiyatlarına Etkisi: Kilis Örneği. *Ormanlık Dergisi* 10(2), 43-53.
- Uslu, C. (2002). *Adana Sofulu çöp depolama alanı örneğinde faaliyet sonrası alternatif kullanımların toplumsal fayda ve maliyet değerlendirmeleri*. (Doktora tezi).
- Yaman, K. ve Muşmul, G. (2018). Çevre ve ekonomi ilişkisi üzerine genel bir değerlendirme. *Ekonomi İşletme ve Yönetim Dergisi*, 2(1), 66-86.
- Yayar, R. ve Karaca, S. S. (2014). Konut fiyatlarına etki eden faktörlerin hedonik modelle belirlenmesi: TR83 bölgesi örneği. *Ege Akademik Bakış*, 14(4), 509-518.
- Yılmaz, F. ve Koç, A. A. (2018). Beydağları Sahil Milli Parkı Ekonomik Değerinin Seyahat Maliyeti ve Koşullu Değerleme Yöntemleri ile Belirlenmesi. *Akdeniz Üniversitesi İktisadi ve İdari Bilimler Fakültesi Dergisi*, 18(38), 1-22. doi:<https://doi.org/10.25294/auibfd.492736>
- Yurdakul, N. M. (2021). *Kentsel açık yeşil alanların ekonomik değerinin seyahat maliyet yöntemi ile belirlenmesi: 100. Yıl Parkı örneği* (Yüksek Lisans Tezi).



NAMLU HARMONİK DÜZENLEYİCİSİNİN ATIŞ İSABETLİLİĞİNE ETKİSİ

Musa PEKÖKSÜZ

ORCID code: 0000-0002-5622-3583

Ali ÖĞÜT

ORCID code: 0000-0003-1848-0578

İbrahim KILINÇOĞLU

ORCID code: 0000-0003-3564-8416

Mete KALYONCU

ORCID code: 0000-0002-2214-7631

Akdaş Silah A.Ş., Huğlu/Konya/TÜRKİYE

Konya Teknik Ü. Mühendislik ve Doğa Bil. Fak. Makina Mühendisliği Bölümü, Konya/TÜRKİYE

Özet

Bu çalışmada, namlu harmonik düzenleyicisi (NHD)'nin atış isabetliliğine etkisi sayısal olarak incelenmiştir. Silah ateşlendiğinde mermi, yüksek basınç altında namlu boyunca hareket eder ve yüksek bir kinetik enerji ile hedefe doğru uçar. Bu hareket esnasında, hem yüksek basıncın namlu tabanına etki etmesi hem de mermi ile namlu arasındaki anlık etkileşim nedeniyle namlu titreşim yapar. Bu titreşim, silahın atış isabetliliğini önemli ölçüde etkiler. Dolayısıyla isabetli atış için namlu titreşimi, hassas bir şekilde kontrol edilmesi gereken önemli bir parametredir. Silah kullanıcıları tarafından uzun menzilli, isabetli ve hassas atış istenmesi nedeniyle namlu harmonik düzenleyiciler giderek daha fazla talep görmektedir. NHD, namlu ağzına/ucuna yakın bir yerde namluya bağlanan küçük miktardaki bir kütledir. NHD kullanmak suretiyle namlu titreşimi kontrol edilerek namlu ağzının deplasmanı ve açısı merminin namludan ne zaman ayrılacağını belirleyecek şekilde tam olarak ayarlanabilir. İdeal olarak, merminin namluyu çok az veya hiç hareket etmediğinde terk etmesi arzu edilir. NHD ayarlama işlemi, farklı miktarlardaki kütlelere sahip NHD'lerin 91,44 metredeki (100 yard) hedefe atış yaparak ve burada elde edilen atış isabetliliği değerlendirilerek yapılır. En uygun atış isabetliliği elde edilene kadar NHD kütlesi ve namluya bağlanacağı yer değiştirilir. Namlu kullanımı süresince yıprandıkça veya değişik mühimmatlar kullanıldığı zaman bu işlemin birden çok kez yapılması gerekir. Bu çalışmada, namlu ağzı deplasmanını ve açısını kontrol etmek için namluya bağlanan NHD'nin performansı karşılaştırmalı olarak araştırılmıştır. İncelenen NATO standardı 5,56 mm kalibreli bir tüfeğin namlusu, mükemmel bir şekilde düz ve boru şeklinde olan Euler-Bernoulli çubuğu olarak modellenmiştir. NHD'nin kütlesi ve namlu ucundan uzaklığı, merminin namludan çıktığı andaki namlu ağzı deplasmanını ve açısını değiştirir. Dolayısıyla bu durum atış isabetliliğini etkiler. Farklı kütlelere sahip NHD lerin atış isabetliliğini nasıl etkilediği sayısal ve grafiksel olarak sunulmuştur. Atış isabetliliğini iyileştirebilmek amacıyla uygun bir NHD kullanılabileceği gözlemlenmiştir.

Anahtar Kelimeler: Namlu Harmonik Düzenleyicisi (NHD), Namlu Dinamiği, Namlu Harmonikleri, Namlu Ağzı Deplasmanı, Atış İsbetliliği



EFFECT OF BARREL TUNER ON SHOOTING ACCURACY

Abstract

In this study, the effect of barrel tuner (NHD) on shooting accuracy was numerically investigated. When the gun is fired, the bullet moves along the barrel under high pressure and flies towards the target with a high kinetic energy. During this movement, the barrel vibrates due to both the high pressure acting on the bottom of the barrel and the instantaneous interaction between the bullet and the barrel. This vibration significantly affects the shooting accuracy of the gun. Therefore, barrel vibration is an important parameter that must be precisely controlled for accurate shooting. Barrel tuners are increasingly in demand due to the long-range, accurate and precise shooting demand by gun users. NHD is a small amount of mass that attaches to the barrel near the muzzle/tip. By controlling muzzle vibration using NHD, the displacement and angle of the muzzle can be precisely adjusted to determine when the bullet leaves the barrel. Ideally, it is desirable for the bullet to leave the barrel with little or no movement. NHD tuning is done by shooting NHDs with different amounts of mass at the target at 91.44 meters (100 yards) and evaluating the accuracy of the shot obtained there. The mass of the NHD and its attachment to the barrel are changed until optimum shooting accuracy is achieved. This process needs to be done more than once as the barrel wears out during use or when different ammunition is used. In this study, the performance of the NHD attached to the barrel to control the muzzle displacement and angle was investigated comparatively. The barrel of the examined NATO standard 5,56 mm caliber rifle was modeled as a Euler-Bernoulli rod, which was perfectly straight and tubular. The mass of the NHD and its distance from the muzzle change the muzzle displacement and angle of the bullet as it exits the muzzle. Therefore, these affect shooting accuracy. It is presented numerically and graphically how NHDs with different masses affect shooting accuracy. It has been observed that an appropriate NHD can be used to improve shooting accuracy.

Keywords: Barrel Tuner, Barrel Dynamics, Barrel Harmonics, Muzzle Position, Shooting Accuracy

GİRİŞ

İhtiyaç duyulan en uygun silahı seçerken ve/veya hali hazırda sahip olunan silah için en önemli husus silahın isabetliliğidir. Ateşli silahlar için, isabetlilik, hedeflenen şeyi tam olarak vurma yeteneğidir. Silahın ateşlenmesi sonucunda namlu içinde hızlı bir basınç artışı oluşur ve namlu halat benzeri bir şekilde titreşim yapar. Silahın ateşlenmesi sonucu ortaya çıkan namlunun harmonik salınımları, merminin iç balistiğinin son aşamasını ve buna karşılık dış balistiğinin başlangıç durumunu etkiler ve bu nedenle, isabetlilik üzerindeki etkilerini sınırlamak için en aza indirilmesi veya ayarlanması gerekir. İsbetlilik şu şekillerde geliştirilebilir: İlk olarak, namlu serbestçe titreşmezse, namlu ağzının hareket şekli tahmin edilemez hale gelir ve bu da daha sonra vuruş noktasının (point of impact, POI) kaymasına ve tahmin edilemez olmasına neden olacaktır. Bu nedenle atış sırasında tüfeğin namlusunun herhangi bir yere temas etmemesi çok önemlidir. Namlu, dipçığın ön ucuna dokunmadan tüm uzunluğu boyunca serbestçe titreşebilmelidir. Gerçekten, hiçbir şey namluya, kundağa, aksesuara veya başka bir şeye dokunmamalıdır. Titreşim ve dolayısıyla vuruş noktası, ancak bu şekilde her bir farklı atışta tutarlı olacaktır. İkincisi, namlu titreşimi genliği, atış dağılımı genliğini etkilemektedir. Namlu titreşiminin genliği yüksekse, namlunun dalganın üstündeki ve altındaki durumu arasındaki fark ve dolayısıyla vuruş noktaları arasındaki fark daha yüksek olacaktır. Dolayısıyla, titreşim dalgalarının genliğini düşük tutmak tüfeğin isabetliliğini artıracaktır. Namlu titreşim dalgalarının genliği, esas olarak namlu kalınlığına ve uzunluğuna ve ayrıca mekanizma dipçik rijitliğine bağlıdır. Daha kısa ve kalın namlular, ince ve uzun namlulara göre daha rijittir ve dolayısıyla daha isabetli atışlara sahiptir. Ek olarak, mekanizma ile dipçik



arasındaki sıkı ve sağlam montaj, genellikle daha iyi doğruluk ve tutarlılığı garanti eder. Üçüncüsü, titreşim sırasında namlunun durumunun statik olduğu çok kısa (mikro saniye) zaman aralıkları vardır. Titreşim dalgasındaki bu noktalara düğüm adı verilir. Her mermi namluyu düğüm aralıklarında terk ederse, her bir farklı atışta vuruş noktası kayması minimum olacaktır. Bu amaca, merminin namlu süresi üzerinde çalışarak, namlu dalgası bir düğümdeyken mermi çıkışını yapmak için daha kısa veya daha uzun yaparak (barut miktarını ayarlayarak) ulaşılabilir. Diğer seçenekler ise, titreşimini belirli bir mühimmat ile eşleştirmek için namluyu belirli bir uzunlukta kesmek ve/veya titreşimi ayarlamak için namluya ağırlık eklemektir. Harmonik kelimesi, silahlarda meydana gelen titreşimleri tanımlamak amacıyla kullanılır. Mallock, bir tüfeğin "harmoniklerinin ayarlanabileceği" önermesinde bulunmuştur [1]. Mallock, bunu öne süren ilk kişi olmayabilir ancak bu fikrin bir yüzyıldan uzun süredir var olduğu ve yeni bir fikir olmadığı anlaşılmaktadır. NHD üzerine çalışan birçok bilim insanı ve ticari firma söz konusudur [1-6]. NHD adı verilen bazı harici aksesuarlar, harmonik dalga modelini değiştirmek için namluya monte edilebilir, böylece titreşim modlarının düğüm noktaları mermi namluyu terk ederken mümkün olduğunca namlu ucuna yakın olacak şekilde kaydırılır (Şekil 1). NHD, mühimmatta değişiklik yapmadan bir tüfek performansını ve namlu-mühimmat ilişkisini harici olarak değiştirebilen tek cihazdır. Ateşli silahlar dünyasında namlu titreşimleri üzerine çalışan birçok bilim insanı olmuştur [7-22].

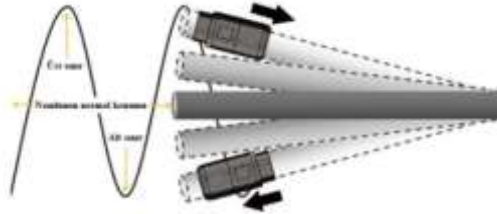

Şekil 1. Namlunun titreşim hareketi ve namlu harmonik düzenleyicisi ayarı

Ateşli silah, mermiyi namlu boyunca hareket ettirmek için küçük bir patlama oluşturur ve bu patlama nedeniyle silahın kendisi de dahil olmak üzere yakındaki her şey kısa bir süre titreşim yapar. Dünyanın en hızlı tüfek mermileri saniyede yaklaşık 1219 metre hızla hareket eder, ancak bu hız bile, namluyu saniyede 6096 metreden fazla hareket ettiren, ateşlenen bir mermi sonucu meydana gelen titreşimlerin yanında çok yavaş kalır. Sonuç olarak; merminin tamamen sabit bir namludan çıkma şansı yoktur. Bu durum görülemez, ancak silahın namlusu her atışta titreşim yapar ve bu titreşimler silahın nihai isabetliliğine ulaşmasını engeller. Namlu harmonikleri, tüfekte yapılan her atış sırasında namluda oluşan titreşimlerin eğilimi ile ilgilidir. Namlu salınımları çok hızlı gerçekleşir, namlu boyunca hareket eden merminin hızından çok daha fazladır, bu da merminin namludan nötr bir konumda çıkması pek olası olmadığı anlamına gelir. Bir mermi namlunun içinde hareket ederken oluşan namlunun harmonik titreşim frekansını değiştirmek amacıyla, namlu ucuna veya ön kısmına bir NHD takılır. Her ticari firmanın NHD tasarımı farklıdır. Örneğin Şekil 2 de görülen NHD, standart namlu dışlarına vidalamaya uygundur ve dişli kilitleme bileşeni ile kilitlenecek üç parçaya sahiptir. Namluya vidalanan iç kovan boyunca ayarlanan ve uygun nokta bulunduğu birbiri kilitlenen iki tırtıllı somun kullanır. Ön somunda ve iç manşonda oyulmuş derecelendirmeler vardır, böylece 0,001 inç (0,025 mm) hassas, tekrarlanabilir ayarlamalar mümkündür. NHD, standart olarak iki adet 6 mm (her biri 60 gram) genişliğinde somunla birlikte kullanılır. Alternatif somun ağırlıkları da mevcuttur. Ayrıca, farklı namlu uzunlukları ve kalınlıkları, daha ağır veya daha hafif bir harmonik düzenleyicisi gerektirebileceğinden, örneğin burada üç farklı ağırlık somunu vardır. Bunlar 6mm (60 gram), 8mm (80 gram) ve 10mm (100 gram) kalınlıkta somunlardır. Somunlar, farklı farklı toplam ağırlık seçeneklerini sağlamak için NHD üzerinde farklı kombinasyonlarda bir araya getirilebilir. NHD zaman, titizlik ve sabır ister, ancak işe yarar. İsbetlilik söz konusu olduğunda, NHD kullanmak en doğru yöntemdir.



Şekil 2. Namlu harmonik düzenleyicisi

DİNAMİK MODELLEME

Bu çalışmada incelenen benzer namluya sahip NATO standardı 5,56 mm kalibreli bir tüfek Şekil 3' de görülmektedir. Tüfek bir saldırı tüfeğidir. Namlu ağzının konumunun ve namlu harmoniklerinin ayarlanabilmesi için namlu ucuna bir NHD montaj edilmiştir (Şekil 4). Silahın ateşlenmesi sonucu namluda oluşan titreşimlerin etkisini azaltmak için namlu ağzı konumuna NHD' nin kütlelerinin ve namlu ucuna olan mesafesinin etkisi incelenmiştir.



Şekil 3. Bu çalışmada incelenen namluya sahip tüfek

NHD' nin ateşleme dinamiklerinin başlangıcında silah namlusunun başlangıç koşullarındaki değişiklikleri azaltarak silahın doğruluğunu ve kesinliğini artırması beklenmektedir. NHD' nin namlu ağzının dikey düzlemdeki konumuna odaklanılmıştır. Namlunun ilk üç titreşim modu dikkate alınmıştır. Namlunun dinamik olarak modellenmesi için sonlu elemanlar yöntemi seçilmiştir. Silah namlusu ve namlunun ucundaki NHD Şekil 4' te görülmektedir.



Şekil 4. Namlu harmonik düzenleyicisine sahip namlu

İncelenen tüfeğin namlusu, herhangi bir imalat hatası olmaksızın mükemmel bir şekilde düz ankastre Euler-Bernoulli çubuğu olarak modellenmiştir (Şekil 5). Sönümlü ikinci mertebeden hareket denklemlerinin atalet, sönüm ve rijitlik matrislerini oluşturmak için bu yaklaşım kullanılmıştır. Ankastre Euler-Bernoulli çubuğunun bir boru şeklinde olduğu varsayılmıştır. Silahın ateşlenmesi sırasında namlu hareketini temsil eden bir matematiksel model geliştirmek amacıyla, namlunun bir ankastre çubuk için hareket denklemlerinin kullanılabileceği şekilde elastik davrandığı varsayılmıştır. Bu durumda, sınır koşulları sabit-serbest bir konfigürasyon içindir.

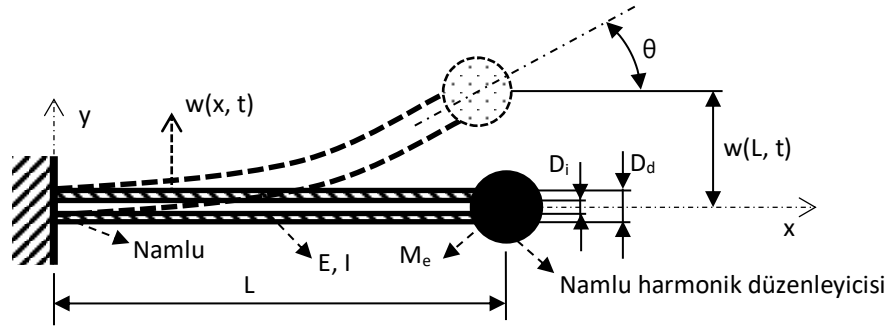

Şekil 5. Ankastré çubuk olarak modellenen namlu ve namlu harmonik düzenleyicisi

Klasik sönümlü bir sistem için genel hareket denklemi aşağıdaki şekildedir:

$$m\ddot{y} + c\dot{y} + ky = F(t) \quad (1)$$

Yukarıdaki denklem, eşitliğin sağ tarafında bir zorlama fonksiyonuna tabi tutulan tek bir serbestlik dereceli sistem içindir. Yalnızca tek bir serbestlik derecesi için olsa da bu denklem, Modal Analiz süreci aracılığıyla n serbestlik derecesini analiz etmek için kullanılabilir. Bu durumda denklemin n serbestlik derecesi için daha uygun olan şekli matris formatıdır:

$$[M]\{\ddot{y}\} + [C]\{\dot{y}\} + [K]\{y\} = \{F(t)\} \quad (2)$$

Burada, sistem için [M]; kütle matrisi, [C]; sönüm matrisi ve [K]; rijitlik matrisidir. Sistemin serbest tepkisi ve özdeğerleri yalnızca kütle ve rijitlik matrisinden belirlenir. Kütle matrisi, her bir mii değeri, namlunun toplam kütesine bölünen ayırık segmentlerin sayısına eşit olan bir diyagonal matristir. Sönüm matrisi [C] normalde matematiksel modelleme sırasında tahmin edilir veya deneysel test yoluyla ampirik olarak belirlenir. Bu matematiksel modelin amaçları doğrultusunda, bu çalışmada her bir serbestlik derecesi için sönüm değerinin %5 olduğu varsayılmıştır.

$t = 0'$ da, merminin hala ateşlenmediği ve mermi yatağının içinde olduğu ve henüz hareket başlamadığı varsayılır. Merminin namlu mesafesi x boyunca U hızındaki hareketine karşılık gelen t zamanında, müteakip mermi konumu $x=Ut$ 'dir. Söz konusu mermi 900 m/s namlu çıkış hızına kadar ulaşabilir. Dolayısıyla mermi, cevabın ilk L/U kadarlık zamanında namlu titreşimlerinden etkilenir. Uzunluğu 368,30 mm olan namlu için etki süresi, $t_i = L/U = 0,3683/900 = 0,00041$ saniyedir. Ancak, bu hatalı bir anlık hızdır ve ilk vuruş, yanma, basınç ve merminin namludan çıkışı için gerçekçi süreyi hesaba katmaz. Mühimmat endüstrisinde kullanılan ampirik verilerle uyumlu olarak bu çalışmada etki süresi yani merminin namludan çıkış süresi 0,001 saniye veya buna karşılık gelen ortalama mermi hızının 368,30 mm/s olduğu varsayılmıştır. Silahın ateşlenmesi geniş bant uyarım sağladığından, zorlama fonksiyonunun bu çalışmada incelenen namluda uyarılan modun doğal frekansında gerçekleştiği varsayılırsa ankastré çubuk için hareketli bir kuvvet etkisi altında kalması durumunda aşağıdaki denklemin yazılması mümkündür:

$$\ddot{q}_i + \omega_i^2 q_i = \frac{2^{1/2}P}{m} \sin(\omega_i t) \quad (3)$$

$2^{1/2}$; ankastré çubuk üzerinde hareket eden bir kuvvet için çözümüne özel bir normalleştirme faktörü, P; hareket eden kuvvetin büyüklüğüdür. Ancak bu denklem ankastré bir çubuk dikkate alındığında tek başına yeterli olmaz. Dolayısıyla ankastré çubuğun mod şekillerinin de dikkate alınması gerekir. Mod şekilleri denklemi ise aşağıdaki gibidir:

$$\phi = A \cosh\left(\lambda \frac{x}{L}\right) + B \sinh\left(\lambda \frac{x}{L}\right) + C \cos\left(\lambda \frac{x}{L}\right) + D \sin\left(\lambda \frac{x}{L}\right) \quad (4)$$

Burada λ_i ; özdeğer denkleminin kökleridir. λ_i özdeğerlerinin bulunabilmesi için sınır şartlarının



bilinmesi gerekir. Bu çalışmada çubuk, şekildeki gibi ankastre çubuk olarak kabul edilmiştir. Ayrıca ucuna noktasal bir kütle bağlanmıştır (Şekil 4). Böyle bir çubuğun sınır şartları aşağıdaki şekildedir:

$$\phi(0,t) = 0, \quad \phi'(0,t) = 0, \quad EI\phi''(L,t) = 0, \quad EI\phi'''(L,t) = -M_e \omega^2 \phi(L) \quad (5)$$

Sınır şartlarında ϕ denklemi yerine konur ve gerekli işlemler yapılırsa A, B, C ve D için dört adet denklem bulunur. Bu denklem takımının katsayılar determinantı sıfıra eşitlenirse frekans denklemi aşağıdaki şekilde elde edilir:

$$1 + \cos\lambda \cosh\lambda = \lambda(M_e/\rho AL) (\sin\lambda \cosh\lambda - \cos\lambda \sinh\lambda) \quad (6)$$

Bu transandant denklemin nümerik olarak çözülmesinden λ_i öz değerleri bulunur. Ankastre çubuğun ucundaki noktasal kütle olmadığı zaman, ankastre çubuğun ilk dört moduna ait öz değerler 1.875, 4.694, 7.855 ve 10.996 şeklindedir. Ucuna kütle bağlandığı zaman ise λ_i ler $M_e/\rho AL$ yükleme oranına bağlı olarak değişir. Ankastre bir çubuk için, Denklem 3' teki sinüs ifadesi, Denklem 4' teki mod şekli denklemi ile değiştirilirse aşağıdaki denklem bulunur:

$$MF_i = \frac{2^{1/2} P \phi_i}{\mu_{ii}} \quad (7)$$

Yukarıdaki modal kuvvet denkleminde (Denklem 7), ϕ_i ; modal etki ve μ_{ii} ; i. düğüm için modal kütle değeridir. Modal kütle matrisi $[\mu]$, cevap hesaplamasında orantılı değerler elde etmek için gereklidir ve aşağıdaki dönüşüm formu sonucu elde edilir:

$$[\mu] = \{\phi\}^T [M] \{\phi\} \quad (9)$$

Bu noktada, her bir mod için hareket kuvveti MF_i hesaplanabilir ve bu da yukarıda gösterilen mod denkleminin sağ tarafıyla sonuçlanır. Bu durumda namlunun modellenmesi için kullanılan ankastre çubuğun cevap denklemi aşağıdaki şekilde olur:

$$\ddot{q}_i + \omega_i^2 q_i = \frac{2^{1/2} P \phi_i}{\mu_{ii}} = MF_i \quad (10)$$

Bu modal kuvvet, yalnızca mermi namlu boyunca hareket ederken uygulanabilir. Zamanın diğer tüm anlarında, denklemin sağ tarafındaki modal kuvvet sıfırdır. Bu modal hareket denklemi, aşağıdaki formun modal dönüşümü kullanılarak türetilir:

$$\{\phi\}^T [M] \{\phi\} \ddot{q} + \{\phi\}^T [C] \{\phi\} \dot{q} + \{\phi\}^T [K] \{\phi\} q = MF_i \quad (11)$$

Denklem 10 aşağıdaki gibi konvolüsyon integrali kullanılarak çözülebilir.

$$q(t) = \frac{1}{m\omega_d} \int_0^t F(\tau) e^{-\xi\omega(t-\tau)} \sin\omega_d(t-\tau) d\tau \quad (12)$$

Bu konvolüsyon integralini değerlendirmenin ve modal kuvvetle çarpmanın sonucu modal koordinatlardır ve her mod için hareket denklemi q ifadesini veren mod şekli matrisi ϕ ile çarpılarak fiziksel koordinatlara dönüştürülür. Süperpozisyon ilkesinden dolayı, toplam cevap, zamanın her anında her mod için q değeri toplanarak elde edilebilir. Sonuç olarak $w(x,t) = \phi(x)q(t)$ olarak elde edilir (Şekil 4). Bu işleme değişkenlere ayırma metodu denir. Namlu ağzında meydana gelen deplasmanlar $w(L,t)$ ve namlu ağzı açısı θ' dir.

SAYISAL UYGULAMA

Bu çalışmada kullanılan 5,56 kalibrelik saldırı tüfeğine ait namlunun geometrik ve mekanik özellikleri Tablo 1 de verilmiştir. NHD' nin ayarlanabilmesi için iki adet parametre söz konusudur: Birincisi NHD' nin kütlesi (M_e) ikincisi ise NHD' nin namlu ağzına olan mesafedir (Şekil 4). Bu çalışmada, NHD' nin namlu ağzına olan mesafesi kütlesine (M_e) oranla daha az etkili olduğundan



dolayı isabetliliğe sadece kütlelerin (M_e) etkisi dikkate alınmıştır. NHD' nin kütlesi 60, 80 ve 120 gram olarak ele alınmış ve isabetliliğe olan etkisi incelenmiştir. İncelenen namluda uyarılan modun birinci, ikinci ve üçüncü doğal frekansta gerçekleştiği varsayılmıştır. İlk üç titreşim modu dikkate alınarak namlu ağız deplasmanı, açısı ve merminin 91,44 metrede (100 yard) meydana gelen dikey hatası hesaplanmıştır.

Tablo 2' de farklı uyarılan modlara karşılık namlu ağız açısı, θ [$^\circ$] ve merminin 91,44 metrede (100 yard) meydana gelen dikey hatası [mm] verilmiştir. NHD' nin kütlesi (M_e) arttıkça namlu ağızının açısı küçülmekte ve dikey hata miktarı azalmaktadır. Uyarılan mod ikinci mod olduğunda değerler negatif diğerlerinde ise pozitif olmaktadır. Şekil 6' da ilk üç titreşim modunun, uyarılan farklı modlardaki zorlamalara karşın, namlu ağız deplasmanına olan etkisi görülmektedir. Şekil 6' da verilen cevaplar incelendiğinde en etkili modun ikinci mod olduğu görülmektedir. Şekil 7' de NHD' nin kütlelerinin namlu ağız deplasmanına olan etkisi görülmektedir. NHD kütleleri 60, 80 ve 100 gram olarak seçilmiştir. NHD' nin kütlesi arttıkça namlu ağız konumu nötr konuma yaklaşmaktadır. Dolayısıyla ikisi birbiriyle zıt orantılı olarak değişmektedir.

Tablo 1. Namlunun geometrik ve mekanik özellikleri

D_i [mm]	D_d [mm]	L [mm]	E [N/m ²]
5,56	19,05	368,30	210×10^9

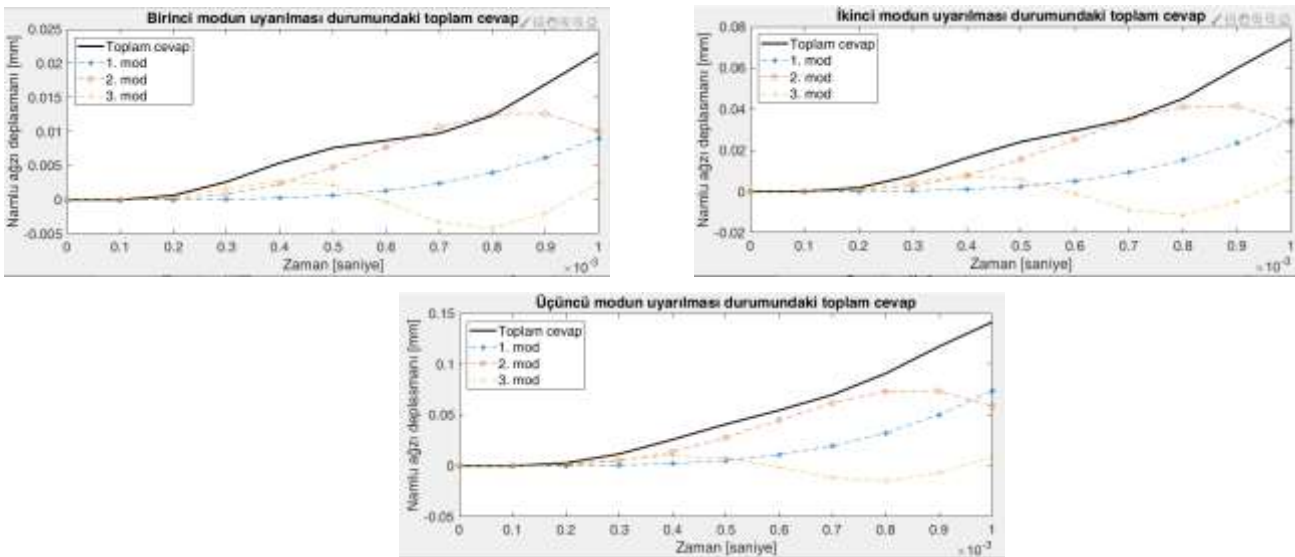

Şekil 6. Titreşim modlarının namlu ağız deplasmanına etkisi



Tablo 2. Namlu ağzı açısı, θ [°] ve 91,44 metrede (100 yard) meydana gelen dikey hata [mm]

Uyarılan Mod	$M_e=0$ gram		$M_e=60$ gram		$M_e=80$ gram		$M_e=120$ gram	
	θ [°]	Hata	θ [°]	Hata	θ [°]	Hata	θ [°]	Hata
1	0,0051	8,08	0,0022	3,52	0,0018	2,80	0,0011	1,80
2	-0,0711	-113,46	-0,0314	-50,08	-0,0251	-40,05	-0,0164	-26,19
3	0,2179	347,69	0,0973	155,30	0,0784	125,18	0,0523	83,42

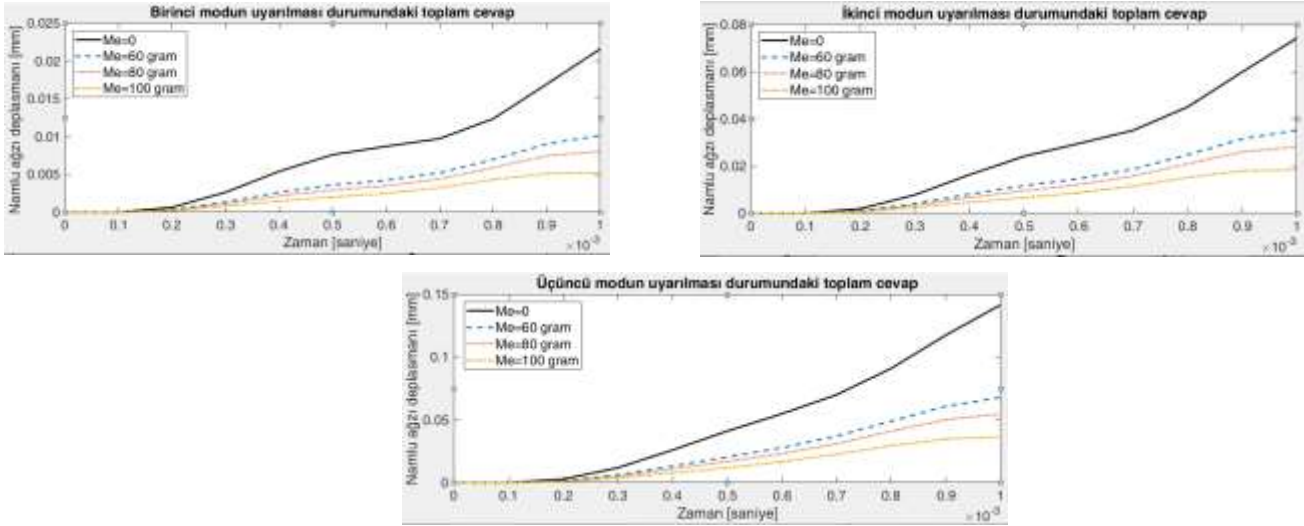

Şekil 7. Namlu ağzı deplasmanının namlu harmonik düzenleyicisi kütlesine göre değişimi

SONUÇ

Bu çalışmada, NHD' nin atış isabetliliğine olan etkisi sayısal olarak incelenmiştir. Namlu ağzı deplasmanını ve isabetliliği merminin hızı ve uyarım frekansı yani uyarılan titreşim modu da etkilemektedir. Bu etkiler sabit tutulmak suretiyle NHD' nin kütlesinin, merminin namludan ayrıldığı anda atış sırasındaki namlu davranışı ve namlu ağzı deplasmanı üzerindeki etkisi incelenmiştir. NHD' nin kütlesi uygun bir şekilde arttıkça namlu ağzı deplasmanı nötr konuma yaklaşmakta ve isabetlilik iyileşmektedir. NHD' nin kütlesi ile namlu ağzı deplasmanı arasında zıt ve doğrusal olmayan bir ilişki vardır. Namlu ucunda oluşan titreşimlerin azaltılması, namlu harmoniklerinin ayarlanabilmesi ve isabetliliğin iyileştirilebilmesi için uygun bir NHD tasarlanabileceği gözlemlenmiştir.

KAYNAKLAR

- [1]. Mallock, A., Vibrations of Rifle Barrels, Proceedings of the Royal Society of London, Philosophical Transactions of the Royal Society, Royal Society of London, Cilt 68, sayfa 327, 1901-01-01
- [2]. Barrel Tuner Vibration Analysis: Effects of tuner adjustments on vibration frequency and the shift in barrel node points, <http://www.varmintal.com/atune.htm>
- [3]. Accurizing, <https://en.wikipedia.org/wiki/Accurizing>
- [4]. Article on AccuMajic Accurizer, <http://www.stocks-rifle.com/gmag1.htm>
- [5]. The Vibrations of a Barrel Tuned for Positive Compensation, http://www.geoffrey-kolbe.com/articles/rimfire_accuracy/tuning_a_barrel.htm
- [6]. O'Neil, Daniel, The Optimization of Rifle Barrel Harmonics, Graduate College Dissertations and Theses 1608, University of Vermont, Mechanical Engineering Department, Master of Science (MS), 2022



- [7]. Den Hartog JP 1956. Mechanical Vibrations. New York: McGraw-Hill.
- [8]. Koç MA et al. 2018. Dynamic analysis of gun barrel vibrations due to effect of an unbalanced projectile considering 2-D transverse displacements of barrel tip using a 3-D element technique, Latin American Journal of Solids and Structures, 15(9), e57.
- [9]. Esen İ and Koç MA 2015. Optimization of a passive vibration absorber for a barrel using the genetic algorithm. Expert Syst. Appl. 42, 2 (February 2015), 894–905.
- [10]. Littlefield AG, Kathe EL, Durocher R 2002b. Dynamically tuned shroud for gun barrel vibration attenuation. Smart Struct. Mater. 2002: Damping Isol. 4697, 89–97.
- [11]. Littlefield A, Kathe E, Messier R, & Olsen K 1997. Gun barrel vibration absorber to increase accuracy. New York: US Army Armament Research, 19970606150. (pp. 1–13).
- [12]. Littlefield A, Kathe E, Messier R, & Olsen K 2002. Design and validation of a gun barrel vibration absorber. New York: US Army Armament Research, 20020304089. (pp. 2–23)
- [13]. Kathe E 2001. Lessons Learned on the Application of Vibration Absorbers for Enhanced Cannon Stabilization, Shock and Vibration 8(3-4):131-139.
- [14]. Käthe E 1996. MATLAB® Modeling of Non-Uniform Beams Using the Finite Element Method for Dynamic Design and Analysis, U.S. Army ARDEC Report, ARCCB-TR-96010, Benet Laboratories, Watervliet, NY, April.
- [15]. Dursun T, Büyükcivelek F and Çağrıhan U 2017. A review on the gun barrel vibrations and control for a main battle tank, Defence Technology 13: 353-359.
- [16]. Büyükcivelek F 2011. Analysis and Control of Gun Barrel Vibrations, Ph.D. Thesis, METU.
- [17]. Dursun T, Büyükcivelek F and Çağrıhan U 2017. A review on the gun barrel vibrations and control for a main battle tank, Defence Technology, Volume 13, Issue 5, Pages 353-359.
- [18]. Aksoy T, Özgen GO, Acar B 2020. Design of a tuned vibration absorber for a slender hollow cylindrical structure. Mechanics Based Design of Structures and Machines, 48(5), 615-648.
- [19]. Nugraha AS, Budiwantoro B, Rijanto E 2014. Design of vibration absorber using spring and rubber for armored vehicle 5,56 mm caliber rifle, Mechatronics, Electrical Power, and Vehicular Tech., 05, 75-82.
- [20]. Peköksüz, M., Kılınçoğlu, İ., Kalyoncu, M., 2022, Vibration Suppression of a Gun Barrel Using Tuned Mass Damper, 11th Int. Istanbul Scientific Research Congress, İstanbul, 15-17 October, pp. 290-296.
- [21]. Peköksüz, M., Kılınçoğlu, İ., Kalyoncu, M., 2022, Namlu Harmonik Düzenleyicisinin Namlu Ağzı Konumuna Etkisi, 5. Uluslararası Fen Bilimler ve İnovasyon Kongresi, Ankara, 11-12 Nov., pp.107-116.
- [22]. Peköksüz, M., Tellioğlu, H., Kılınçoğlu, İ., Kalyoncu, M., 2022, Bir Namlunun Namlu Ağzı Titreşiminin Modellenmesi ve Analizi, 2. Uluslararası Taşkent Modern Bilimsel Araştırmalar Kongresi, 16-17 Aralık 2022, Taşkent, Özbekistan.



SECURITY ISSUES AND PRECAUTIONS ON IoT DEVICES

Bahadır Furkan KINACI

İsa AVCI

Karabük University, Engineering Faculty, Railway System Department, Karabük, Türkiye.

Karabük University, Engineering Faculty, Computer Department, Karabük, Türkiye

Abstract

IoT (Internet of Things) has started to take place more and more in the daily life of individuals as consumer products and different sectors and industrial systems with the developing technology. According to the era when the internet did not mean much more than the security of the personal computer for the end user, the use of networks formed by objects that connect at various layers and perform different functions naturally makes possible security vulnerabilities much more threatening. IoT devices generally operate in a "set and forget" fashion, with some remaining permanently connected to the network, performing only part of a larger mechanism. Therefore, the risk of rendering the entire network inoperable by attacks on relatively routine and non-vital devices is likely to weaken IoT systems. Considering that technology has played an important role in our lives, it is seen that the precautions to be taken for the security of IoT networks are becoming more vital day by day. This study will discuss security requirements, IoT Security, Privacy, Threats, and Challenges in IoT systems. In addition, this study will mention the precautions and international standards to be taken regarding cyber security against IoT systems.

Keywords: Internet of Things (IoT), Security Requirements, Security Attacks, and Measures, Standards

Özet

IoT (Nesnelerin İnterneti), gelişen teknoloji ile birlikte farklı sektörler ve endüstriyel sistemler ile tüketim ürünleri olarak bireylerin günlük hayatında giderek daha fazla yer almaya başlamıştır. İnternetin son kullanıcı için kişisel bilgisayarın güvenliğinden çok daha fazlasını ifade etmediği döneme göre, çeşitli katmanlarda birbirine bağlanan ve farklı işlevleri yerine getiren nesnelerin oluşturduğu ağların kullanılması doğal olarak güvenlik açıklarını çok daha fazla olası hale getirmektedir. tehditkar IoT cihazları genellikle "kur ve unut" şeklinde çalışır ve bazıları ağa kalıcı olarak bağlı kalarak daha büyük bir mekanizmanın yalnızca bir kısmını gerçekleştirir. Bu nedenle, nispeten rutin ve hayati olmayan cihazlara yapılan saldırılarla tüm ağı çalışamaz hale getirme riski IoT sistemlerini zayıflatabilir. Teknolojinin hayatımızda önemli bir rol oynadığı düşünüldüğünde IoT ağlarının güvenliği için alınması gereken önlemlerin her geçen gün daha da önem kazandığı görülmektedir. Bu çalışma IoT sistemlerinde güvenlik gereksinimleri, IoT Güvenliği, Gizlilik, Tehditler ve Zorlukları tartışacaktır. Ayrıca bu çalışmada IoT sistemlerine karşı siber güvenlik konusunda alınması gereken önlemler ve uluslararası standartlardan bahsedilecektir.

Anahtar Kelimeler: Nesnelerin İnterneti, Güvenlik Gereksinimleri, Güvenlik Saldırıları ve Önlemleri, Standartlar



INTRODUCTION

The term "Internet of Things" refers to a new technology used in many different ways and does not need human help. A web app also connects to a network of connected mechanical and digital computers called the Internet of Things (IoT). Garten's report says that by 2020, there will be about 20 billion intelligent objects. It is connected to the Internet and exchanges much information, making it easier for people to live (Asthon, 2009). IoT can be defined as a global infrastructure enabling advanced services by interconnecting physical and virtual things using interoperable information and communication technologies (ICTs) (Guillemin and Friess, 2009). The rapid progress of telephone and internet technology has not only made progress in telephone and internet technologies but also caused great changes in human life. Thanks to these changes, it has become easier to lead a comfortable life, and at the same time, it has become accessible to everyone thanks to the decreasing costs with the development of technology. Nowadays, not only smartphones connect to the internet but also refrigerators, washing machines, televisions, air conditioners, etc. Indispensable items in our homes can also be connected to the internet. All these developments bring along some problems and provide great comfort and luxury. In this report, we will examine the concept of the internet of things (IoT) and the latest security problems and solutions that come with the internet of things. IoT has shown great development in the last few years with the development of technology and smart systems. Due to rapid developments in mobile communication, Wireless Sensor Networks (WSN), Radio Frequency Identification (RFID), and cloud computing, communication between IoT devices is becoming more convenient. IoT devices can communicate with each other and exchange data. This communication can be unidirectional or bidirectional. The world of IoT includes a wide variety of devices, including cameras, sensors, robots, autonomous vehicles, smartphones, personal computers, PDAs, laptops, tablets, and other embedded handheld devices. IoT devices rely on cost-effective sensors and wireless communication systems to communicate with each other and transfer meaningful information to the central system. IoT's main goals are configuring a smart environment and conscious stand-alone devices such as smart living, smart goods, smart health, and smart cities (Vlacheas et al., 2013). There are currently nine billion devices in China, which is expected to reach 24 billion by 2025. In the future, IoT will completely change our lifestyles and business models. Figure 1 shows that there is a world population of 7.78 billion, the number of IoT devices is 42.62 billion, and this number has been almost 6 times in the year 2022 (Statista and World Population, 2022).

In IoT networks, privacy, authentication, data integrity, and access control increases many security and privacy issues, such as IoT devices being targeted by attackers and intruders daily. One assessment reveals that 70% of IoT devices are very easy to hack. Therefore, there is a great need for an effective mechanism to secure internet-connected devices from hackers and intruders. Wireless networks constitute the weakest area in IoT systems and show a lot of vulnerability in terms of security (Avcı, 2022). The main areas of use of wireless networks are military, commercial, healthcare, retail, and transportation. It has been observed that IoT technologies have recently directed the attention of many researchers in this field. When IoT technologies are examined, they will play a vital role in the future and change our lifestyles, standards, and business models (Riggins and Wamba, 2015). There is a great need to create efficient security and privacy protocols in IoT networks to ensure privacy, authentication, access control, and integrity, among other technological advances. This article provides a comprehensive and comprehensive study of security and privacy issues in IoT networks (Dave et al., 2015).

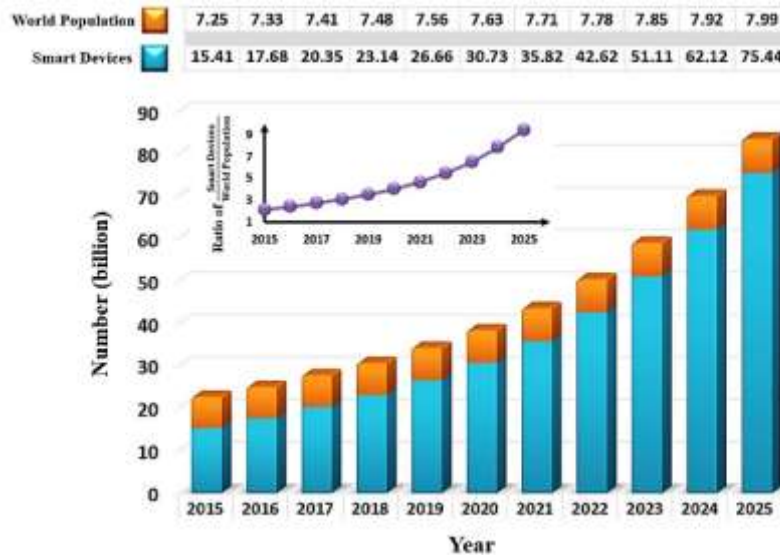

Figure1. Comparison Between the Estimated World Population and the Projected Number of Smart Devices Connected to the Internet: 2015–2025 (Statista and World Population, 2022).

IoT SECURITY, PRIVACY, THREATS, AND CHALLENGES

Internet security has an important place for other physical devices that can connect to the Internet, such as mobile devices and computers. Just as security measures have been taken for mobile devices and computers and new measures are being developed rapidly in this area, the same precautions must now be taken for the Internet of Things. Hackers pose a threat to every device that goes to the Internet. Thanks to the seized devices, hackers can carry out many large or small-scale attacks (Ballon et al., 2011; Kumar and Patel, 2014; Abomhara and Køien, 2014; Chen et al., 2014). All devices and people continue to work interconnected to provide service anytime and anywhere in IoT. Most internet-connected devices are vulnerable to various privacy and security issues as they do not have adequate security protection mechanisms. Some security requirements for IoT need to be met to prevent networks in the operating environment of IoT devices from being compromised by malicious people. Some of the key features of a secure network are (Atzori et al., 2010; Hossain et al., 2015):

- Resilience to Attacks
- Data Authentication
- Access Control
- Client Privacy

IoT application data can be industrial, enterprise, consumer, or personal. The data of this app will be secured against theft and tampering and kept confidential. IoT improves connectivity between devices, but problems with scalability, availability, and response time remain. Security is a concern since data is transmitted securely over the Internet. Government regulations, such as the Health Insurance Portability and Accountability Act (HIPA), may apply when data is transferred across borders internationally. Among various security challenges, the most important is the Internet of Things (Petrolo et al., 2017; Sarker et al., 2022):

- Data Privacy
- Data Security
- Insurance Concerns
- Lack of Common Standard
- Technical Concerns



- Security Attacks and System Vulnerabilities
- System Security
- Application Security
- Network Security

IoT Standards Organizations working for the security of IoT devices around the world come together and take an active role in their regions. These are listed below (Lee et al., 2021):

- ETSI (European Telecommunications Standards Institute)
- IoTSF (Internet of Things Security Foundation)
- GSMA (The GSM Association)
- NIST (National Institute of Standards and Technology)
- IEEE (Institute of Electrical and Electronics Engineers)
- IEC (International Electrotechnical Commission)
- ENISA (European Union Agency for Cybersecurity)

The main challenges in IoT device and software security can be examined under 4 main headings. These are security, low power, reliability, and network capabilities.

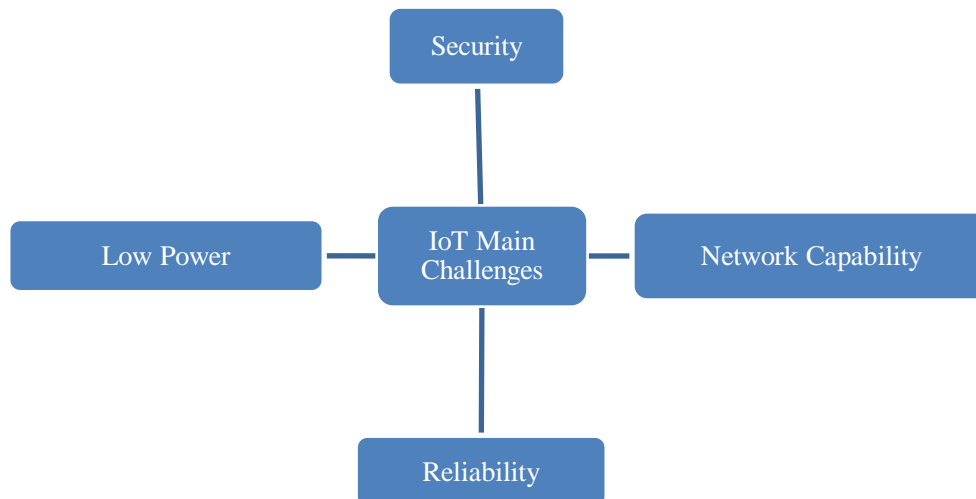

Figure 2. IoT Main Challenges

There are many cybersecurity threats to the Internet of Things today. Cyber-attacks against IoT devices are shown in Figure 3. Attention should be paid to the precautions and solution methods to be taken to prevent these attacks.

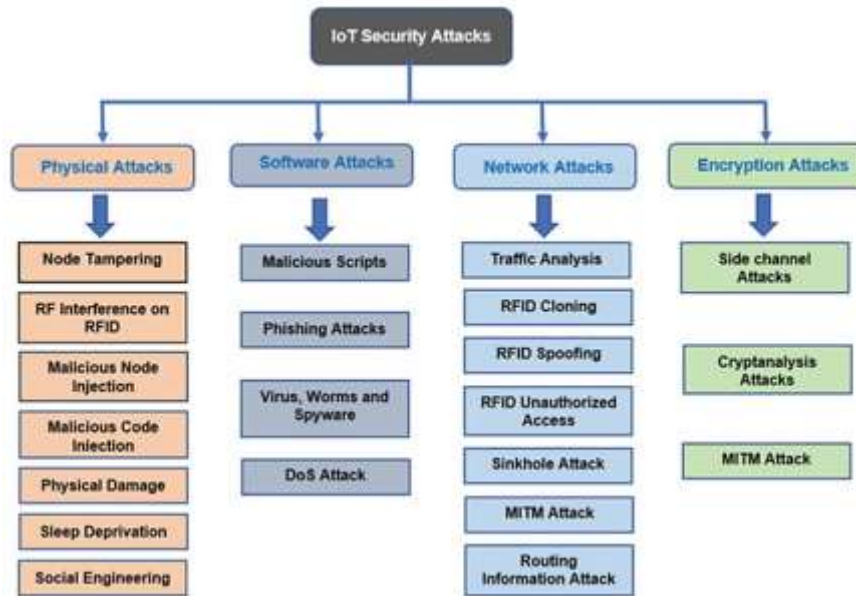

Figure 3. Types of security attacks in the IoT system (Atlam and Wills, 2020).

There are many security problems in the field of the IoT as with mobile devices and computers. The 10 biggest security problems encountered in this field are examined, and solutions to these problems are shared below (Gokhale et al., 2018; Soumyalatha, 2018; Lee et al., 2021; Avcı, 2022):

- **Weak Security Update**
The IoT is designed for easy use. For this reason, even if they are reliable when first purchased, new security vulnerabilities may be found by hackers over time, and these devices may become unprotected.
Solution: For this reason, device manufacturers will release new security updates over time, and users should install these updates on their devices.
- **Brute Force Attack And Default Username / Password**
In many DDOS attacks, hackers use the "admin" username and password. This password and username are defined by default on many devices, and users do not change this username and password. For this reason, many devices become vulnerable to these attacks.
Solution: To avoid these attacks, the user name and password should be changed after the device is obtained.
- **Weak IoT Device Management**
IoT and IOMT have made all devices in health, retail, manufacturing, and life sciences interoperable. In this way, in an ecosystem where all devices are in communication, the management of devices and the fact that one device does not affect the other in terms of security becomes an extremely difficult problem to manage. Especially in the health sector, the use of new devices together with old devices causes operational problems, financial records, and customer data security.
Solution: For the solution of this problem, an IoT device management system should be used, and necessary device configurations, controls, management, system updates, and maintenance should be done through this system.
- **Insufficient Data Protection**
One of the most important security problems in IoT applications is poor data communication and data storage. One of the most important challenges to the security and privacy of IoT devices is the use of neglected IoT devices to leak data.



Solution: The most important solution in this regard is encryption. Data encryption prevents unauthorized use, access, and visibility of data.

- **Application Security Vulnerable**

As in every software, there are vulnerabilities in IoT devices software. For this reason, it should be accepted that there have been vulnerabilities in the software of IoT devices from the beginning [5]. Using these vulnerabilities, hackers can obtain important data from the normal operation of the devices' applications. It is quite difficult to avoid this problem completely.

Solution: The best solution to this problem is to perform a strong login validation on system logins.

- **Supplier Software/Update Support**

Another important factor for IoT devices is how quickly the company that produces the device supports this vulnerability after a bug has emerged after the system vulnerability has been detected. Although some system vulnerabilities or bugs do not cause much trouble, some vulnerabilities are vital. In this case, the company that produces the IoT devices should release new updates on this issue as soon as possible and fix these errors.

Solution: The shortest solution to this problem is to procure that device by knowing in advance what policy the company that produces the IOT devices follows in such cases.

- **Data Security And Privacy Concerns**

Data security and privacy is the biggest problem in today's life. Companies can now collect data not only from mobile devices and the web but also from all devices connected to the internet, thanks to IoT. These collected data can be sold to other companies and are interpreted in different ways by analyzing the data. All of these become security issues for users.

Solution: Users should collect the data to be collected in the form of personal private/sensitive data and data that can be stored within the framework of different confidentiality rules, and take measures such as deleting the data that is not needed from memory and if the data is to be collected definitively, it can be collected within a legal framework.

- **Using an Unreliable Interface**

Every IoT device we use receives and transmits data. IoT devices need applications, communication protocols, and services in all this data communication. In data communication between devices, the lack of sufficient authentication, weak encryption, or no encryption can cause major security problems.

Solution: Device authentication, communication protocols between devices in data communication between devices, and assistance from digital security certificates are required.

CONCLUSION

Considering the significance of security in IoT applications, it is important to establish a security mechanism in IoT devices and communications networks. It is also not recommended to use default passwords for devices and to read the security requirements of the devices before using them for the first time to protect them from intruders or security threats. Disabling unused features can reduce the possibility of security attacks. It is also important to examine the different security protocols used in IoT devices and networks. Things that make IoT insecure devices:

- Data is very sensitive and critical as we are talking about our personal devices,
- They have insecure interfaces and software,
- Update problems,
- Insecure in terms of network services,
- They have insufficient authentication and configurations,
- You can dive in by doing BFA with a few tools and a good list,
- Devices are within the reach of everyone, physical security is a problem



To ensure the security of IoT devices, the security frameworks of international standards that have seen the world should be followed. These standards should be followed, and reference should be taken to ensure safety in production, development, and dissemination. In addition, software and hardware security should be given importance. If cloud systems are used, their security must be investigated. Priority should be given to the development of domestic and national products. In addition, the university, government, and private companies should work together to develop national standards.

REFERENCES

- Abomhara, M., & Kjøien, G. M. (2014, May). Security and privacy in the Internet of Things: Current status and open issues. In 2014 international conference on privacy and security in mobile systems (PRISMS) (pp. 1-8). IEEE.
- Ashton, K., (2009). That “Internet of Things” thing: In the real world, things matter more than ideas. RFID Journal. Available at: <http://www.rfidjournal.com/articles/view?4986>. [28.10.2022].
- Atlam, H.F., Wills, G.B. (2020). IoT Security, Privacy, Safety and Ethics. In: Farsi, M., Daneshkhah, A., Hosseinian-Far, A., Jahankhani, H. (eds) Digital Twin Technologies and Smart Cities. Internet of Things. Springer, Cham. https://doi.org/10.1007/978-3-030-18732-3_8
- Atzori, L., Iera, A., & Morabito, G. (2010). The internet of things: a survey. Computer Network 54 (15): 2787–2805.
- Avcı, İ., (2022). Akıllı Evlerde IoT Teknolojileri ve Siber Güvenlik. Avrupa Bilim ve Teknoloji Dergisi, Ejosat Özel Sayı 2022 (ICAENS-1), 226-233. DOI: 10.31590/ejosat.1080228
- Ballon, P., Glidden, J., Kranas, P., Menychtas, A., Ruston, S. & Van Der Graaf, S. (2011). Is there a need for a Cloud platform for European smart cities? eChallenges e-2011 Conference Proceedings. https://doi.org/10.1007/978-3-319-44924-1_10.
- Chen, S., Xu, H., Liu, D., Hu, B., & Wang, H. (2014). A vision of IoT: Applications, challenges, and opportunities with china perspective. IEEE Internet of Things Journal, 1(4), 349-359.
- Dave, B., Kubler, S., Framling, K. & Koskela, L. (2016). Opportunities for enhanced lean construction management using Internet of Things standards. Automation in Construction. 61, 86-97.
- Gokhale, P., Bhat, O., & Bhat, S. (2018). Introduction to IOT. International Advanced Research Journal in Science, Engineering and Technology, 5(1), 41-44.
- Guillemin, P., & Friess, P., (2009). Internet of Things strategic research roadmap. Cluster European Research Projects. Technical Report.
- Hossain, M. M., Fotouhi, M., & Hasan, R. (2015, June). Towards an analysis of security issues, challenges, and open problems in the internet of things. In 2015 IEEE world congress on services (pp. 21-28). IEEE.
- Kumar, J. S., & Patel, D. R. (2014). A survey on internet of things: Security and privacy issues. International Journal of Computer Applications, 90(11).
- Lee, E., Seo, Y. D., Oh, S. R., & Kim, Y. G. (2021). A Survey on Standards for Interoperability and Security in the Internet of Things. IEEE Communications Surveys & Tutorials, 23(2), 1020-1047.
- Petrolo, R., Loscri, V., & Mitton, N. (2017). Towards a smart city based on Cloud of Things, a survey on the smart city vision and paradigms. IEEE Transactions on Emerging Telecommunications Technologies. 28, e2931. <https://doi.org/10.1002/ett.2931>.
- Riggins, F. & Wamba, S.F. (2015). Research directions on the adoption, usage and impact of the



INTERNATIONAL ASIAN CONGRESS ON CONTEMPORARY SCIENCES – VII

Internet of Things through the use of big data analytics. 48th Hawaii International Conference on System Sciences. DOI:10.1109/HICSS.2015.186.

Sarker, I. H., Khan, A. I., Abushark, Y. B., & Alsolami, F. (2022). Internet of things (IoT) security intelligence: a comprehensive overview, machine learning solutions and research directions. *Mobile Networks and Applications*, 1-17.

Soumyalatha, S. G. H. (2016, May). Study of IoT: understanding IoT architecture, applications, issues and challenges. In 1st International Conference on Innovations in Computing & Networking (ICICN16), CSE, RRCE. *International Journal of Advanced Networking & Applications* (Vol. 478).

Statista, (2018). Internet of Things (IoT) connected devices installed base worldwide from 2015 to 2025. Available at: <https://www.statista.com/statistics/471264/iot-number-of-connected-devicesworldwide/>[24.10.2022].

World Population, (2018). Available at:

<http://www.geoba.se/population.php?pc=world&page=3&type=028&st=rank&asde=&year=2025>[24.10.2022].

Vlacheas, P., Giaffreda, R., Stavroulaki, V., Kelaidonis, D., Foteinos, V., Poullos, G., Demestichas,

P., Somov, A., Biswas, A.R. & Moessner, K. (2013). Enabling smart cities through a cognitive management framework for the Internet of Things. *IEEE Communications Magazine*. 51(6), 102-111.



INVESTIGATION OF TRAFFIC AND PASSENGER INFORMATION STANDARDS USED IN INTELLIGENT TRANSPORTATION SYSTEMS

Bahadır Furkan KINACI

İsa AVCI

Karabuk University, Railway System Department, Karabuk, Turkey.

Karabuk University, Computer Engineering, Karabuk, Turkey.

Abstract

Due to the developing urbanization and rapid movement requirements, many developments have emerged in transportation systems. Due to these developments and increasing density, it is an important issue that systems can be operated together and mutually. With the advances in technology, digitalization and digital infrastructure systems have started to develop. These emerging developments have led to the development of IoT (Internet of Things) technology and have found use in every subsystem suitable for digitalization. Intelligent transportation systems (ITS) structure, which has emerged in recent years and has an important place in the development of transportation systems, has started to form and has become a global field of study. Intelligent transportation systems have enabled vehicles, infrastructures, and all kinds of IoT-based devices to exchange data with each other. This emerging communication structure allows the formation of a safe, efficient, fast, environmentally friendly, and low-cost transportation structure. Traffic and passenger information structures created according to certain standards and rules in smart transportation systems have formed an important topic. In this study, the current situation will be analyzed by examining the Traffic and Passenger information standards used in smart transportation systems around the world.

Keywords: Intelligent Transportation Systems, Traffic and Passenger Information, Standards

INTRODUCTION

With the developing technology, ITS emerges as a subject of great importance for countries. When the application areas of ITS systems are examined, it has been determined that there are applications in all areas of road, air, sea, and rail transport. It is expected that all systems and subsystems needed while performing ITS applications will be efficient, operable, cost-effective, and compatible with interoperability. The efficient structures needed for ITS applications are shaped within the framework of regulations, reports, and standards put forward by organizations with expertise in the relevant field. The standards that emerged because of the studies carried out by expert organizations contribute to the studies as they describe the most appropriate way needed to do a job [1,2].

Although the standard studies carried out are based on interest, during the emergence of the standard, due to similar reasons such as the expectations of the standard-setting institution, application areas, existing systems, and the requirements of these systems, it may not be able to create a fully sufficient reference for each system to be established. The expectations and capabilities of the systems to be implemented regarding reference to the relevant standards will reveal the holistic or departmental applicability of the standard [3].



INTELLIGENT TRANSPORTATION SYSTEM (ITS)

Intelligent Transportation System is a system that enables the collection, storage/processing of real-time data and the application of the results obtained by applying advanced electronics, information, and communication technologies to roads, vehicles, and sub-systems to maximize efficiency in the transportation sector and to ensure safe and comfortable transportation. ITS aims to reduce travel times in smart cities, increase traffic safety, use existing road capacities efficiently, increase mobility, use energy efficiently and reduce damage to the environment. In line with these purposes, vehicles, equipment, infrastructure, and superstructure systems are developed. In the ITS structure, it becomes easier to receive and send data with versatile data transmission and redundant communication systems between the center and the field. ITS are information communication-based systems that include data exchange and monitoring, measurement, analysis, and control mechanisms. Cooperative Intelligent Transport System (C-ITS) [4]. When the sub-application components of ITS are examined; smart infrastructure, smart vehicle, smart traffic management (smart intersection management, electronic supervision, etc.), smart transportation management (smart stop, smart public transportation, etc.), and electronic payment systems and applications are discussed. From the perspective of transportation management, ITS can be grouped into four main groups.

These groups are:

- ATIS- Advanced Traffic Information System
- ATMS- Advanced Traffic Management System
- APTS- Advanced Public Transport System
- EMS- Emergency Management System

ITS provides significant access to cleaner, safer, and more efficient transport systems. Due to their superiority, ITS systems have found application in all areas of road, air, maritime, and railway transportation and have been integrated into all systems and subsystems used. In Figure 1, examples of the application areas of ITS systems are shown.



Figure 1. ITS Application Areas [5]



ITS has become the focal point of various policies and action plans around the world. When the foundations of AUS studies are examined, it first started with Comprehensive Automobile Traffic Control Systems (CACCS) in Japan in the late 1960s and early 1970s, and Electronic Route Guidance Systems (ERGS) in the USA and Germany. After these years, ITS applications started to become widespread in the mid-1980s, and applications such as electronic toll collection systems, smart intersection control systems, passenger and driver information systems, and traffic control centers were implemented in the 90s. With these applications, joint projects started to be developed by starting cooperation between the state and the private sector.

COOPERATIVE INTELLIGENT TRANSPORTATION SYSTEM (C-ITS)

Cooperative Intelligent Transport System (C-ITS) is one of the technologies that aim to increase the safety, efficiency, and environmental performance of transportation as an innovative technology and enables vehicles to interact with each other and their environment. A safe and comfortable journey is ensured by informing the drivers about all the events that occur during the journey through communication devices placed inside the vehicle and on the roadside, and vehicle-vehicle and vehicle-infrastructure communication. C-ITS is a work on the agenda with the creation of test corridors and the development of driverless/connected vehicle applications, especially in European Union countries.

TRAFFIC AND PASSENGER INFORMATION STANDARDS

In this section, traffic and passenger information standards in intelligent transportation systems will be examined. While providing the examinations, ISO and CEN institutions, which are important standard-setting institutions in the field, were used. In the study, it was determined that the relevant standards were not sufficient and the studies should be continued.

Table 1. Traffic and Passenger Information Standards

Standard	Description
ASTM Archiving Traffic Data	Standard Specification for Archiving ITS-Generated Traffic Monitoring Data [7]
CEN 16157-1 DATEX-Context and Framework for TM&I	DATEX II Data Exchange Features for Traffic Management and Information - Part 1: Context and Framework [8]
CEN 16157-2 DATEX Position Referencing for TM&I	DATEX II Data Exchange Features for Traffic Management and Information - Part 2: Location Reference [9]
CEN 16157-3 DATEX Status Broadcast for TM&I	DATEX II Data Exchange Features for Traffic Management and Information - Part 3: Status Broadcast [10]
CEN 16157-4 DATEX - VMS Publications for TM&I	DATEX II Data Exchange Features for Traffic Management and Information - Part 4: Variable Message Sign (DMI) Broadcasts [11]
CEN 16157-5 DATEX for TM&I - M/E Data Broadcasts	DATEX II Data Exchange Features for Traffic Management and Information - Part 5: Measured and Detailed Data Broadcasts [12]
CEN 16157-6 DATEX for TM&I – Parking Lot Publications	DATEX II Data Exchange Features for Traffic Management and Information - Part 6: Parking Lot Publications. [13]
ISO 14819-1 RDS-TMC Protocol	Traffic and Travel Information Messages via Traffic Message Coding -- Part 1: Coding Protocol for Radio Data System - Traffic Message Channel (RDS-TMC) Using ALERT-C [14]
ISO 14819-2 RDS-TMC Codes	Traffic and Travel Information Messages via Traffic Message Coding -- Part 2: Event and Information Codes for the Radio Data System - Traffic Message Channel (RDS-TMC) Using ALERT-C [15]
ISO 14819-3 RDS-TMC Position Ref	Traffic and Travel Information Messages via Traffic Message Coding -- Part 3: Location Reference for Radio Data System -- Traffic Message Channel (RDS-TMC) Using ALERT-C [16]



ISO 14819-6 RDS-TMC Encryption	TTI Messages Via Traffic Message Encoding -- Part 6: Encryption and Conditional Access for Radio Data System -- Traffic Message Channel ALERT C Coding [17]
ISO 21219-14 TPEG2 - Parking Lot	Traffic and Travel Information (TTI) Via TPEG2 -- Part 14: Parking Information Implementation (TPEG2-PKI) [18]
ISO 21219-15 TPEG2 - Traffic Incident	Traffic and Travel Information (TTI) Via TPEG2 -- Chapter 15: Traffic Incident Compact (TPEG2-TEC) [19]
ISO 21219-24 TPEG2 - Lightweight Encryption	Traffic and Travel Information (TTI) Via TPEG2 -- Part 24: Lightweight Encryption (TPEG2-LTE) [20]
ISO 21219-6 TPEG2 - Message Management	Traffic and Travel Information (TTI) Via TPEG2 -- Part 6: Message Management Container (TPEG2-MMC) [21]

CONCLUSION

ITS applications have entered a continuous development process. It will also continue to increase its importance. ITS applications are an important issue as they reveal a fast, efficient, and safe transportation structure. One of the important topics of ITS applications is traffic and passenger information systems.

In this study, traffic and passenger information standards in ITS applications were examined. It has been determined that ISO and CEN standards are predominant among the examined standards. It has been determined that the existing standard structures are not sufficient and should continue to be developed.

REFERENCES

- U.S. Department of Transportation, Intelligent Transportation Systems Benefits, Costs, and Lessons Learned, Update Report, 2018.
- Tufan, H, Akıllı Ulaşım Sistemleri Uygulamaları ve Türkiye İçin Bir AUS Mimarisi Önerisi, Ulaştırma ve Haberleşme Uzmanlığı Tezi, 2014, Ankara.
- Society of Automotive Engineers of Japan, ITS Standardization Activities of ISO/TC 204, 2020.
- T.C. UAB, «Akıllı Ulaşım Sistemleri (AUS),» 19 04 2022. [Online]. Available: <https://hgm.uab.gov.tr/akilli-ulasim-sistemler-aus>.
- European Telecommunications Standards Institute, «ETSI Kooperatif AUS Sistemleri,» 05 06 2022. [Online]. Available: <https://www.etsi.org/newsroom/news/753-2014-02-joint-news-cen-and-etsi-deliver-first-set-of-standards-for-cooperative-intelligent-transport-systems-c-its>.
- ASTM International, Standard Specification for Retroreflective Sheeting for Traffic Control, USA, 2019.
- ASTM, Archiving Traffic Data, Standard Specification for Archiving ITS-Generated Traffic Monitoring Data.
- CEN, CEN 16157-1 DATEX-Context and Framework for TM&I.
- CEN, CEN 16157-2 DATEX Position Referencing for TM&I.
- CEN, CEN 16157-3 DATEX Status Broadcast for TM&I.
- CEN, CEN 16157-4 DATEX - VMS Publications for TM&I.



INTERNATIONAL ASIAN CONGRESS ON CONTEMPORARY SCIENCES – VII

CEN, CEN 16157-5 DATEX for TM&I - M/E Data Broadcasts.

CEN, CEN 16157-6 DATEX for TM&I – Parking Lot Publications.

International Organization for Standardization, ISO 14819-1 RDS-TMC Protocol.

International Organization for Standardization, ISO 14819-2 RDS-TMC Codes.

International Organization for Standardization, ISO 14819-3 RDS-TMC Position Ref.

International Organization for Standardization, ISO 14819-6 RDS-TMC Encryption.

International Organization for Standardization, ISO 21219-14 Parking Lot.

International Organization for Standardization, ISO 21219-15 Traffic Incident.

International Organization for Standardization, ISO 21219-24 Lightweight Encryption.

International Organization for Standardization, ISO 21219-6 Message Management.



MAVİ HES PROJESİNDE TÜRBİNLERDEKİ SİLT KAYNAKLI AŞINMA BAKIM SÜRESİNİN AMPİRİKSEL ELDE EDİLEN BAKIM SÜRESİYLE KARŞILAŞTIRILMASI

Davut Yılmaz

Dr. Öğretim Üyesi, Ankara Yıldırım Beyazıt Üniversitesi, Mühendislik ve Doğa Bilimleri Fakültesi, İnşaat Mühendisliği Bölümü, Etlik-Keçiören Ankara.
ORCID: <https://orcid.org/0000-0002-9981-7875>

Özet

Mavi Regülatörü ve HES Projesi Değirmendere üzerinde Trabzon-Gümüşhane Karayolunun 40-45. Kilometreleri arasında karayolu kenarında inşa edilmiştir. Kurulu gücü 11,6 MW olan proje, 2012 yılında tamamlanarak hizmete alınmıştır. Normal şartlarda sedimentin göl alanına ulaşmasını önlemek için göl alanının girişine bir tersip bendi inşa edilmiştir. Silt boyutlu sedimentlerin de göl alanında büyük oranda çökmesi amaçlanmıştır. Gölden su alma yapısına geçebilecek siltlerin çökmesini sağlamak için de su alma ağız ile iletim tüneli arasında silt çökeltim havuzu inşa edilmiştir. Mavi Regülatörü membaında 2017 yılında başlayan Trabzon-Gümüşhane yolu inşaatı nedeniyle büyük oranda kazı malzemesi dere kenarında depolanmıştır. Depolanan bu malzemelerin yağış ve akışlarla birlikte göle ve oradan da Hidroelektrik Santrale ulaşması sonucu suyun temas ettiği türbin parçalarında büyük aşınmalar meydana gelmiş ve türbinler zorunlu olarak bakıma alınmıştır. Bu makalede gelen sedimentin kaynağı, miktarı, kayaç tipi ve şekliyle ilgili parametreler belirlendikten sonra Francis tipi olan türbinlerde meydana gelen hasar bölgeleri incelenmiştir. Türbinlere ulaşan siltin dane dağılımı ve konsantrasyonu tahmin edildikten sonra net proje düşüsü ve ampirik yaklaşımlar kullanılarak bakım zamanı tahmin edilmiştir. Tahmin edilen bu bakım zamanı gerçekte vuku bulan bakım zamanı ile karşılaştırılarak ampirik yaklaşımların sonuçları değerlendirilmiştir.

Anahtar Kelimeler: Silt yükü, türbin aşınması, sediment, HES

COMPARISON OF SILT-INDUCED WEAR MAINTENANCE TIME IN TURBINES IN MAVI HEPP PROJECT WITH EMPIRICALLY OBTAINED MAINTENANCE TIME

Abstract

Mavi Weir and HEPP Project on the 40-45th kilometers of Trabzon-Gümüşhane Highway on Değirmendere. The project, with an installed capacity of 11.6 MW, was completed and put into service in 2012. In order to prevent the sediment from reaching the lake area under normal conditions, a reverse dam was built at the entrance of the lake area. It is aimed that the silt-sized sediments will also be deposited to a large extent in the lake area. A silt settling pool was constructed between the intake port and the transmission tunnel in order to allow the sedimentation of silt that may pass from the lake to the water intake structure. Due to the construction of the Trabzon-Gümüşhane road, which started in 2017 upstream of the Mavi Weir, most of the excavated material was stored on the sides of the stream. Since these stored materials reached the lake and then the



Hydroelectric Power Plant by precipitation and flows, great abrasions occurred on the turbine parts that the water came into contact with, and the turbines were taken into compulsory maintenance. In this article, after the parameters related to the source, amount, rock type and shape of the incoming sediment were determined, the damage areas in Francis type turbines were examined. After estimating the grain distribution and concentration of the silt reaching the turbines, the maintenance time was estimated by using the net project head together with empirical approaches. The results of the empirical approaches were evaluated by comparing this estimated maintenance time with the actual maintenance time.

Keywords: Silt load, turbine wear, sediment, HEPP

1-Giriş

Sedimentlerin türbinlere verdikleri zararların tespiti ve bu zararları önlemeye yönelik alınabilecek tedbirler hususunda uzun yıllardır çalışmalar yürütülmektedir (Zu-Yan, M., 1996; Gummer, 2009; Felix ve diğerleri, 2016). Alınacak tedbirlerin başlıcaları arasında sedimentlerin rezervuarlara gelişinin engellenmesi, sediment yüklü suların rezervuarlarda dinlendirilerek sedimentten arındırılması ve aşınmayı önlemek için türbinlerin aşınmaya karşı dirençli malzemeler ile kaplanmasıdır. Trabzon'da Değirmendere akarsuyu üzerinde inşa edilen Mavi Regülatörü ve HES Projesindeki türbinler doğal olarak gelen sedimentlerden değil yol inşaatları nedeniyle akarsuya dökülen-karışan kazı malzemeleri yüzünden 2 yıldan az sürede bakıma ihtiyaç duyar hale gelmiştir. Bu makalede bu durum detayları ile irdelenecektir.

1980'li yıllarda inşa edilen Trabzon-Gümüşhane yolunda Mavi Regülatörünün bulunduğu kesimden akış aşağı doğru kazıdan çıkan kazı malzemelerinin büyük kısmı yamaçtan aşağıya dökülmüştür. Bunun sonucunda da dere yatakları nehir yatağı kotlarında da 10-15 metrelik yükselmeler oluşmuştur. Mavi Regülatörünün membaında ise yerleşim yerleri bulunduğundan yol kazısından çıkan malzemeler depo alanlarına nakledilmiştir. Mavi Regülatörü inşası sırasında yaklaşık 13 metrelik bu yol kazısı malzemesi kazılarak ana kayaya ulaştırılmıştır. Göl alanında ise bu malzemenin büyük bir kısmı temizlenerek göl alanının ölü hacmi artırılmıştır. Yerinden alınmış haritalara göre Mavi Regülatörünün toplam depolama hacmi 63.000 m³, aktif depolama hacmi ise yaklaşık 41.000 m³'tür.

2015 Yılında başlayan yol ve tünel inşaatlarıyla birlikte büyük miktarda kazı ve atık malzemesi hem dere yatağı kenarına önlem alınmadan depolanmıştır. Yağmur ve taşkın sularıyla taşınan malzemenin iri boyutlu olanları tersip bendi sayesinde göl alanının girişinde tutulmuştur (Şekil 1). Tersip bendi önu düzenli olarak boşaltılmıştır. Ancak silt boyutundaki malzeme suyla birlikte taşınarak Mavi Regülatörü rezervuarına taşınmıştır. Göle gelen silt miktarı yılda yaklaşık 5000 m³'e varmıştır. Göl alanının ölü hacmi bir süre sonra silt ile dolmuştur (şekil 2). Balçıklaşan siltin çok zorlu şartlarda ancak bir bölümü boşaltılabilmektedir. Boşaltılan silt hacmi birkaç ay içerisinde yeniden dolmuştur. Ölü hacmin dolmasıyla beraber silt yoğun bir şekilde iletim kanalına girmeye başlamıştır. Hidroelektrik santrale ulaşan silt türbinlerde oyulmalara ve hasara neden olmuştur. Türbinlerdeki oyulmalar sızıntılara ve aşırı titreşimlere yol açmıştır. Titreşimlerin kabul edilebilir sınırları aşması üzerine de türbinler sökülüp tamirata alınmıştır.

Öncelikle gelen silt miktarı ve gelen siltin petrografik yapısı belirlenmiştir. Bu çalışmada silt konsantrasyonu, siltin sertliği, şekil yapısı dikkate alınarak ve net düşü ile türbin tipi hesaba katılarak türbinlerin tamirata girdiği süre ampirik yaklaşımlarla karşılaştırılmıştır.



Şekil 1. Mavi Regülatörü ve HES rezervuar alanı ve tersip bendi.



Şekil 2. Tersip bendini aşarak göl alanında biriken silt (Regülatörün üstünden akış yukarı bakış).

2-Mavi Regülatörü Göl Alanında Biriken Silt Miktarı

Göl alanı gelen siltle dolduğundan ve iş makineleri balçığa saplandığından makine ile girip boşaltmak mümkün olmamıştır. Büyük vinçler yardımıyla askıya alınan ekskavatör veya diğer imkanlarla su alma ağız ve kapaklara yakın olan bölümde 2020 yılında haziran ayının son haftasında ancak 2500 m³ malzeme boşaltılabildiği (Şekil 3).



Şekil 3. Mavi Regülatörü rezervuarından silt boşaltma işlemi.

Göl alanından boşaltılan bu malzemeye rağmen boşatılan kısım yaklaşık 4 ay gibi kısa sürede dolmuştur. Göl alanının boşaltıldığına ve tekrar dolduğuna dair tespitler de mahkemelerin görevlendirdiği bilirkişiler yardımıyla yapılmıştır (Hukuki Yazışmalar, 2020). Hukuki yazışmalardan hareketle göl alanında biriken silt boyutlu malzemelerin ve tersip bendi önünde biriken iri boyutlu malzemelerin her birinin 2020 yılı için yaklaşık 5000'er m³ olduğu sonucuna varılmıştır.

Mavi Regülatörü tersip bendine ve rezervuar alanına gelen malzemelerin çok büyük çoğunluğunun yol ve tünel kazılarında kaynaklandığının tespiti amacıyla da Mavi Regülatörünün hemen membanda yer alan Karakaya HES Projesi Regülatörü önünde biriken malzeme göz önünde bulundurulmuştur.

Mavi Regülatörünün üst kotunda, su toplama havzası büyüklüğü Mavi Regülatörü ve HES Projesinin su toplama havzası büyüklüğünün yaklaşık 1/3'ü olan Karakaya Regülatörü ve HES Projesi bulunmaktadır. Bu proje, yol ve tünel kazılarından daha üst kotta yer almaktadır. Dolayısıyla tesis, Trabzon Gümüşhane karayolu inşaatı tünel ve yol imalatlarından etkilenmemektedir. Karakaya Projesi ve HES Regülatörü projesi 2015 yılında hizmete alınmıştır. 2020 yılında yapılan hukuki tespitlerde, 5 yıldır hizmette olduğu halde Karakaya Projesine ait regülatörün önündeki tersip bendinin önünün dahi dolmadığı tespit edilmiştir (Şekil 4).



Şekil 4. Karakaya Regülatörü ve HES Projesinin tersip bendi ve önünde biriken malzeme (Tersip bendi üzerinden patika beton kaplı yol geçen yapıdır).

Bu durumda yaklaşık 3 kat su toplama havzasına sahip olan Mavi Regülatörü ve HES Projesi göl alanına gelebilecek sediment miktarı da Karakaya Regülatörü tersip bendi önünde biriken malzemenin yaklaşık 3 katı kadar olabileceği değerlendirilmektedir. Karakaya Regülatörü tersip bendi önünde biriken malzeme miktarı dikkate alındığında da Mavi Regülatörü göl alanı girişinde inşa edilmiş olan tersip bendinin yeterli kapasiteye sahip olduğu, normal şartlarda dolmasının yıllar alacağı ve Mavi Regülatörü göl alanı içerisindeki 22.000 metreküplük ölü hacmin de suyun içerisinde askıda taşınan malzemeleri tutmak için iyi bir kapasite olduğu anlaşılmaktadır. Ancak inşaatların başlamasından sonra yol ve tünel kazı malzemelerinin dere yatağına bırakılması sonucu hem tersip bendi önünün her yıl dolduğu hem de askıda taşınan ince malzemenin fazlalığından rezervuardaki ölü hacmin tamamen dolduğu anlaşılmaktadır. Rezervuar alanı ölü hacminin siltle dolması büyük önem taşımaktadır çünkü suyla beraber askıda taşınan malzemelerin tutulmasında en etkin olan yapılar su toplama rezervuarlarıdır (Gummer, 2009). Rezervuarın büyük kısmının siltle dolmasıyla da birlikte askıdaki malzemeler daha az çökelmiş ve suyla birlikte türbinlere taşınmıştır. Taşınan silt boyutlu sudaki yoğunluğundaki büyük artış da türbinlerin kısa sürede aşınmasına yol açmıştır.

Maçka Sulh Hukuk Mahkemesi sorumluluğunda yapılan çalışmalarda (Hukuki yazışmalar, 2020) bilirkişiler yapılmakta olan Zigana tüneline çıkan ince malzemelerin, dinlendirme havuzlarının deliklerinden dereye karıştığı tespit edilmiştir. Yine aynı raporlarda Zigana Tünel inşaatının membaında yer alan **Karakaya Regülatörü ve HES Projesinin** çıkışından alınan su numunelerinin su kalitesi yönetmeliğine uygun olduğu tespit edildiği halde tünel ve yol kazı ve imalatlarından kaynaklı atıkların dereye bırakılması sonucunda HES projesi çıkışından alınan su numunelerinde silisyum malzemesinin konsantrasyonunda da 6 katlık bir artış olduğu tespiti de yapılmıştır. Zigana



Tünelinin akış aşağısında yani mansabında silisyum konsantrasyonundaki söz konusu artışın dereye kontrolsüz biçimde atıkların bırakıldığı da göstermektedir.

Türbinlere ulaşan sediment miktarı yanında taşınan silt boyutlu malzemelerin mineralojik yapısı ve taşınan malzemelerin şekilleri de önem taşımaktadır. Bu nedenle KTÜ Jeoloji Mühendisliği Bölümüne mineralojik çalışmalar yaptırılmıştır.

3-KTÜ Jeoloji Mühendisliği Bölümü Öğretim Üyeleri Tarafından Yapılan Mineralojik ve Petrografik Çalışmalar

KTÜ Jeoloji Mühendisliği Bölümü Öğretim Üyeleri tarafından yapılan çalışmada (Temizel ve Aksoy, 2021); yol ve tünel kazılarında çıkan malzemeler ile göl alanında biriken alüvyonların özellikleri karşılaştırılmıştır. Bu karşılaştırma sonucu, alüvyon malzemesinin hafriyattan (kazılardan) çıkan malzemeler ile benzer özellikler gösterdiği, malzemelerin %60'ının köşeli olduğu, silt ve kum büyüklüğündeki malzemenin ise yaklaşık %50 oranında olduğu tespit edilmiştir. Alüvyon malzemenin; kireçtaşı, dolomitik kireçtaşı, tuf ve andezitlerden oluştuğu tespit edilmiştir.

Alüvyonda yani göl alanında biriken malzemenin köşeli olduğunun tespiti; hem söz konusu silt ve ince kum malzemenin türbinleri aşındırma kabiliyeti açısından önem taşımakta hem de malzemenin kısa bir mesafeden taşınarak göl alanında biriktiğini ortaya koymaktadır. Şayet biriken malzeme, dere yatağında uzun bir taşınma süreci geçirmiş olsaydı, daha yuvarlak daneler taşınması gerekirdi. Bu da göl alanına oldukça kısa mesafede yer alan tünel ve yol kazılarında çıkan malzemenin göl alanında biriktiğini göstermesi açısından önem taşımaktadır.

Bunun yanında, dere kenarına dökülen kazı malzemelerinin yıkanması ve tünellerden çıkan ince malzemenin dereye bırakılması neticesinde normalden çok daha ince malzeme akışa geçmektedir. Yoğun olarak 2015 yılında başlayan yol ve tünel inşaatları nedeniyle çıkan kazı malzemelerinin bir bölümü depolanmış, bir kısmı ise bir şekilde dere yatağına bırakılmıştır. Feyezan döneminde yükselen su seviyesi ve artan debi dere kenarına depolanan malzemenin akıntıyla beraber taşınmasına yol açmıştır. Bunun yanında yağışlı zamanlarda yağış havzasına depolanan malzemelerin yağışlarla beraber yıkanmakta olduğu (Şekil 5) ve özellikle ince malzemelerin taşınarak dereye karıştığı da izahtan varestedir.



Şekil 5. Dere kenarına depolanmış kırılmış beton malzemesi (URL3).

4- ODTÜ Mühendislik Fakültesi, Metalurji Ve Malzeme Mühendisliği Bölümü Tarafından Yapılan Değerlendirmeler

Mavi Regülatörü ve HES Projesi türbinlerinde meydana gelen aşınmalar literatürdeki çalışmalarla karşılaştırılmış ve aşınmaların ince silt gibi malzemelerin kaynaklı olduğu sonucuna varılmıştır. Sudaki silisyum miktarındaki 6 katlık artışın Zigana Tünelindeki çimento yapısından veya delme esnasında kayalardan çıkmış olabileceğini değerlendirilmiştir. Mavi Regülatör ve HES'in Runner Blade, Bottom Ring ve Türbin Ayar Kanatları üzerindeki aşınma morfolojileri silt erozyonu morfolojisi ile birebir eşleşmekte olduğu belirtilmiştir (Şekil 6). Runner kanatları üzerinde oluşan tortudan alınan numunenin kalsiyum, alüminyum, silis oksit olduğu tespit edilmiştir ve kanatlar üzerindeki tortunun, suya karışan çimento artıklarından kaynaklandığı değerlendirilmiştir (Ögel, 2022).



Şekil 6. Türbin Runner (solda). Runner kanatları (sağda) üzerinde suyun neden olduğu aşınma (ok ile gösterilen). (Ögel, 2022).

5-Aşınmaya Yol Açan Siltlerin Özellikleri ve Aşınma Türleri

Türbinlere ulaşan siltlerin 100 μm ile 1.000 μm arasındaki çaplara sahip partikülleri suyun dolaştığı dış hidrolik kontur boyunca kanalize olma eğiliminde olmaktadır (Şekil 7). 100 μm 'nin altındaki partikül çapları için ise durum farklıdır çünkü küçük parçacıklar tüm hidrolik yüzeyleri kaplayan türbülanslı sınır tabakasına girerek yüzeylerde kumlama etkisi yapmaktadır (Şekil 8). Yeterli miktarda olması halinde, ince parçacıklardan kaynaklanan genel aşınma, büyük parçacıklardan kaynaklanan aşınma kadar etkili olabilmektedir. Literatürdeki çalışmalar, akış ayrımı nedeniyle, iç bükülme yüzeyinin (Francis türbin kanadının emme tarafına eşdeğer), partikül boyutu azaldıkça hasarda sürekli bir artış yaşandığını göstermektedir (Gummer 2009). Nitekim Ögel (2022) türbin ayar kanadında, suyun geçtiği yüzeyde görülen aşınma izlerinin silt kaviteasyonu olduğu tespitini yapmakta aynı kanadın su değmeyen yüzeyinde herhangi bir kaviteasyon ve yıpranma bulunmadığına işaret etmektedir (Şekil 9).



(a)



(b)

Şekil 7 Bottom ring'in iç tarafında kalan ve su ile temas eden yüzeylerde abrazyif aşınma morfolojisi (ok ile gösterilen bölgeler.) (Ögel, 2022)

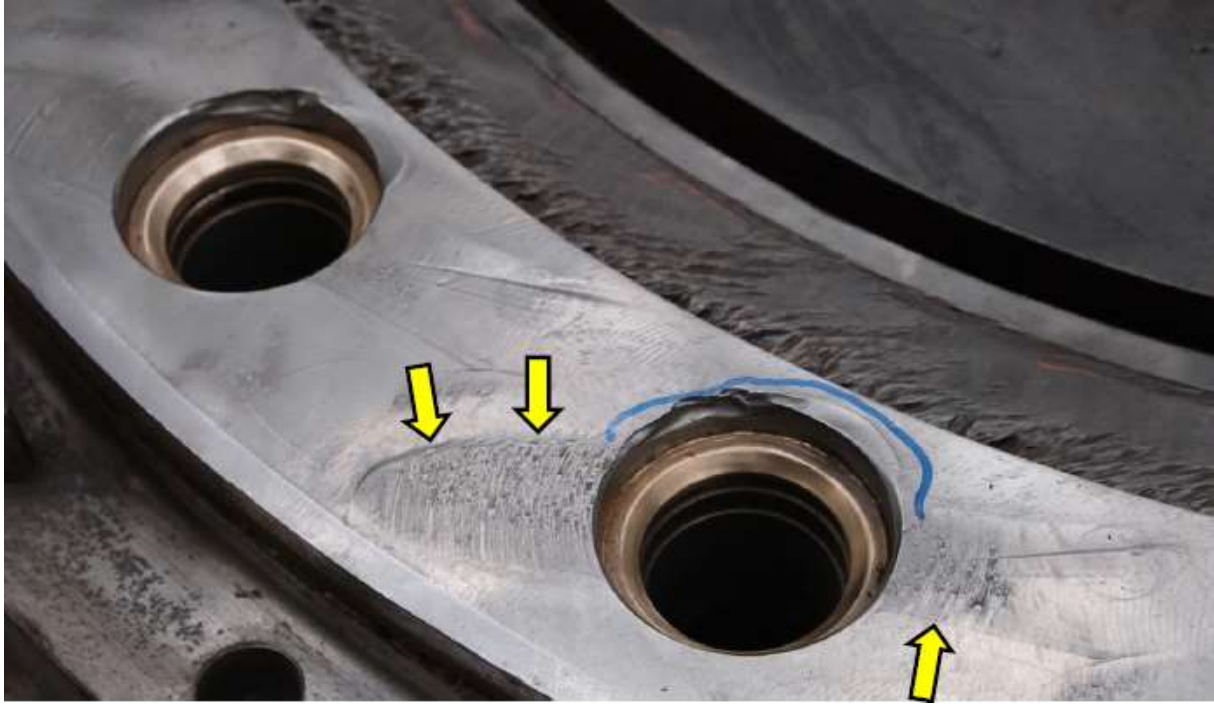

Şekil 8. Türbin ayar kanatlarının “bottom ring” üzerinde oluşturduğu aşınma (Ögel, 2022).

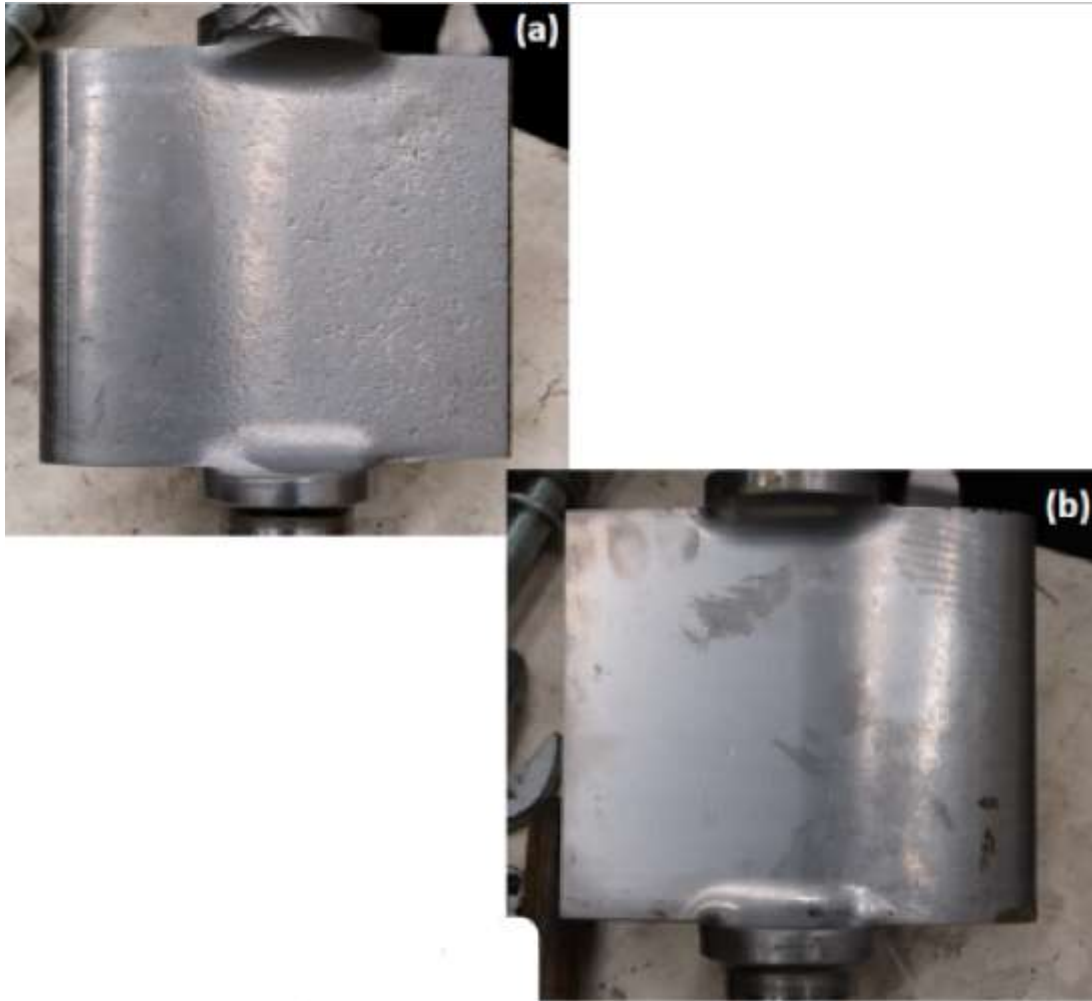

Şekil 9. (a) Türbin ayar kanadında, suyun geçtiği yüzeyde oluşan aşınma izleri bulunmaktadır. (b) Aynı kanadın su değmeyen yüzeyinde ise yıpranma yoktur. (Ögel, 2022)



Parçacık yoğunluğunun etkisi, parçacığın boyutuyla orantılıdır. Daha yüksek yoğunluklu bir partikül daha büyük momentuma sahip olacağından yüzeye ulaşmaya daha yatkın olacaktır. Diğer yandan, sert parçacıklar görece yumuşak yüzeylere daha fazla zarar vermektedir. Mohs sertlik skalasına göre 5 Mohs'luk bir partikül sertliği genellikle hidrolik türbinler için sınır değeri olarak kabul edilir (Gummer 2009). 1'den 10 kadar Mohs Sertlik Skalası Şekil 10'da verilmektedir. Quartz (silisyum) Mohs sertlik skalasında 7. Sırada yer almakta olup çelikten daha serttir.

MOHS SERTLİK ÖLÇEĞİ			
	MİNERAL İSMİ	ÖLÇEK NUMARASI	YAYGIN NESNE
Artan Sertlik ↑	Elmas	10	
	Korindon	9	Matkap ucu (8.5)
	Topaz	8	Çelik çivi (6.5)
	Kuvars	7	Bıçak/ Cam tabak (5.5)
	Ortoklas	6	
	Apatit	5	
	Florit	4	Bakır para (3.5)
	Kalsit	3	
	Jips	2	Tırnak (2.5)
	Talk	1	

Şekil 10. Mohs sertlik skalası (URL 2).

Mavi Regülatörü ve HES ile Köprüyanı Regülatörü ve HES Projelerinde Francis Tipi türbinler kullanılmıştır. Teorik olarak, hasar göreceli serbest akış hızının küpü ile orantılıdır. Bununla birlikte, muhtemelen sınır tabakası etkilerinden dolayı, rölatif (bağıl) serbest akış hızı için genel olarak kabul edilen deneysel olarak belirlenmiş hız üsleri şunlardır (Gummer 2009):

Pelton kovası	: 1,5
Pelton memeleri	: 2,5
Francis koşucuları (runners)	: 3
Francis ayar kanatları (wicket gates) ve yanaklar	: 2,5

Parçacıkların şekli, özellikle parçacığın bir kesme hareketi uyguladığı oyuk erozyonu ile ilgilidir. Keskin kenarlı, düzensiz bir parçacık, yüzey üzerinde çok yönlü veya küresel bir parçacığa göre çok daha büyük zararlı etkiye sahip olabilir. Çalışmalar, oluk açma aşındırma modu altında, tırtıklı bir parçacığın erozyon hızının, yuvarlak parçacığın üç katı kadar olabileceğini göstermektedir (Gummer, 2009).

Partikül konsantrasyonu genellikle litre başına gram (g/l) olarak ifade edilir. Bununla birlikte, genellikle ağırlıkça milyonda parça (ppm) olarak da kullanılır. Yaklaşık 1.000 ppm 1 g/l'ye eşittir. Belirli bir tesis için, partikül konsantrasyonu esasen geçici bir ölçüdür (yani, konsantrasyon ne kadar büyükse, erozyon oranı o kadar yüksek ve dolayısıyla ekipmanın arızaya geçmesi daha kısa sürede gerçekleşir). Pek çok tesiste konsantrasyon ölçülür ve partikül miktarı önceden belirlenmiş bir değeri aştığında, ünitelerin çalışması durdurulur.

Hidrolik reaksiyon türbinlerinde, partiküllerin kaviteasyon üzerindeki etkisi iki katmanlıdır. Çapı 50 µm veya daha küçük olan partiküller kaviteasyon kabarcıkları için çekirdek sağlar. Bu da yeni başlayan kaviteasyonun (saf sudan daha yüksek Thoma sigma değerlerinde) oluşmasına yol açar. Kaviteasyon kabarcığının gelişimi, benzer şekilde kaviteasyonun erken başladığını yansıtır. Hidro-



aşındırıcı erozyonun ikinci, eşit derecede ciddi etkisi, hidrolik konturu yerel olarak değiştirmesidir. Dolayısıyla akışı bozulur ve kavitasyon kabarcığı patlaması eğilimi ve yoğunluğu artar. Kavitasyon kabarcıklarının patlamasından kaynaklanan darbeler, hidrolik yüzeyi yorar ve gevşeterek erozyon hasarına katkıda bulunur. Çarpma partiküllerin hasarlı malzemeyi uzaklaştırmasını kolaylaştırır. Kavitasyon ve erozyon kombinasyonu, "sinerjik" (negatif anlamda) bir etki olarak adlandırılır. İkisinin kombinasyonundan kaynaklanan hasar, her birinin tek başına verdikleri hasarların toplamından çok daha büyüktür (Gummer, 2009).

Francis runnerlar, çarpma erozyonu ve bıçakların uzunluğu boyunca oluk açma ve darbe erozyonunun bir kombinasyonundan dolayı eşit derecede, ciddi malzeme kaybı nedeniyle ön kenarda büyük hasar görürler. Öndeki kenarlar, başlangıçtaki inceliğinden dolayı özellikle hasar görmeye eğilimlidir (Gummer 2009). Bu tip hasarın Mavi HES türbinlerindeki görüntüsü Şekil 11'de verilmiştir.



(a)



(b)

Şekil 11. Runner kanatlarının üzerinde aşınma bölgeleri (okla işaretlenmiştir) (Ögel, 2022)



Yukarıda belirtilen tüm bileşenlerin aşınması, sonuçta verimlilik kaybı anlamına da gelmektedir. Kayıplar:

- Labirent conta ve kılavuz kanat açıklıklarındaki artış hacimsel verimlilik düşüşüne neden olur.
- Ayar kanatlarının ve kızak kanatlarının hidrolik profilindeki değişiklik form verimini düşürür.
- Hidrolik yüzeylerin pürüzlülüğünden kaynaklanan sürtünme kayıplarındaki artış da verimlilik kaybına neden olur.

6-Hidrolik türbinlerde erozyonu tahmin etme yöntemleri

Literatürde farklı erozyon kriterleri olsa da basit olan HxC faktörü, oldukça kullanışlıdır. Burada H: türbinin metre cinsinden net düşü yüksekliğidir ve C, 50 µm daha büyük çaptaki tüm parçacıkların g/l cinsinden ortalama yıllık parçacık konsantrasyonudur.

Hidro-aşındırıcı erozyon hasarı riski için önerilen aralıklar şunlardır (Gummer 2009):

$HxC \geq 7$ ise şiddetli;

$0,7 \leq H \times C < 7$: orta

$H \times C \leq 0.7$: ihmal edilebilir, şekilde değerlendirilebilir.

Zu Yan yaklaşımının bir uzantısı olarak Nozaki tarafından önerilen, g/l cinsinden yıllık ortalama partikül konsantrasyonunun ürünü olan ve partikül boyutu, sertlik, şekil ve yolluk malzemesi değişkenleriyle ilgili katsayıları değiştiren, modifiye partikül konsantrasyon faktörüdür. Faktör Eşitlik, (1)'de verilmiştir.

$$PE = P \times a \times k1 \times k2 \times k3 \quad (1)$$

Burada:

PE : g/l cinsinden modifiye edilmiş, askıya alınmış konsantrasyondur

P : g/l cinsinden ölçülen askıda konsantrasyondur

a, k1, k2 ve k3: Parçacıkların tipine ve geometrisine ve türbin malzemesinin tipine bağlı katsayılar (Tablo 1)

Nihai PE değeri türbin düşü yüksekliği ile beraber kullanılarak Şekil 12'ten bakım süresi tahmin edilir. Şekil 12 Francis runner'ların eğrileri için örnek olarak verilmiştir.



Tablo 1. a, k₁, k₂, k₃ faktörleri

Denklem 1 için Katsayılar	
<u>Partikül Çapı (mm)</u>	<u>a</u>
Yarıçap = 0.05	1
Yarıçap = > 0.05	d/0.05
<u>Partikül Şekli</u>	<u>k₁</u>
Yuvarlak	0.75
Keskin Kenarlı	1.00
Çok Keskin Kenarlı	1.25
<u>Partikül Sertliği</u>	<u>k₂</u>
>3	1
<3	0.5
<u>Türbin Malzemesi</u>	<u>k₃</u>
X5 Cr/Ni 13/4	1.0
Döküm Çelik	2.3
Bronz	4.0
Stelit	0.3

Şekil
Sudaki
tortu

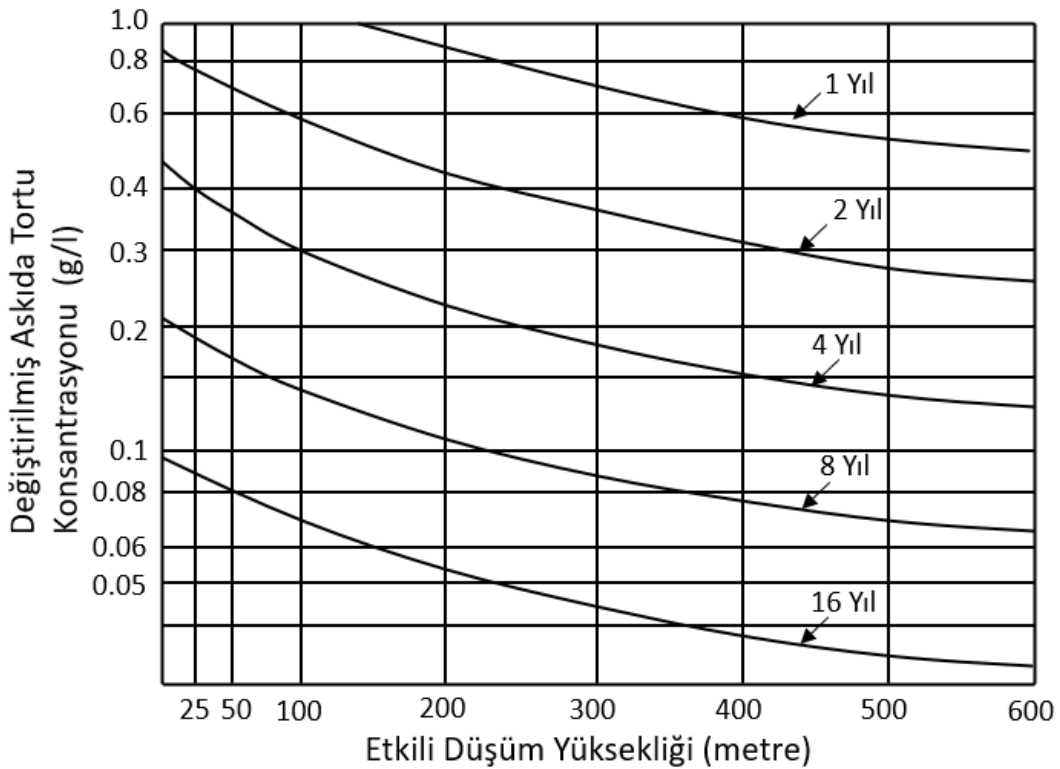

12.
asılı

konsantrasyonuna ve türbinin net düşü yüksekliğine bağlı olarak Francis runnerler için bakımlar arasındaki zaman tahminleri (Gummer, 2009).



7- Siltlerin Santrallere Ulaşmasını Önleme Yöntemleri

Hidro-aşındırıcı erozyona karşı ilk önlem, su tesisine ulaşmadan önce onun etkilerini ortadan kaldırmaktır. Parçacıkların yeterince büyük hacim ve uzunlukta olması durumunda, onların uzaklaştırılmasındaki en etkili yöntem tüm zararlı parçacıkları çökeltecek, büyük bir ana depolama rezervuarı sağlamaktır (Gummer, 2009). Bununla birlikte, çok etkili olmasına rağmen rezervuarın dolması engellenmedikçe rezervuar sadece bir geciktirme cihazı olduğu unutulmamalıdır.

Rezervuarları bulunmayan nehir tipi santrallerde silt boyutundaki ince malzemelerin uzaklaştırılmasında, uygulanabilir tek çözüm, silt çökeltim havuzları inşa etmektir. Ancak bu havuzlar 1 mm'den daha büyük parçacıkları, uzaklaştırmada etkilidir (Gummer, 2009).

Gelen yük üç kategoriye ayrılabilir: Dane çapı 200 µm'den büyük olan parçalar kaba; çapı 75 µm ila 200 µm arasında olanlar orta; ve çapı 75 µm'den küçük olanlar ise ince olarak sınıflandırılabilir. Rezervuarlar, ince boyuta kadar tüm partiküllerin uzaklaştırılmasında etkilidir, ancak çökeltme odalarının kendi sınırlamaları vardır. Neredeyse tüm iri parçacıkları uzaklaştırmalarına rağmen, gelen konsantrasyona bağlı olarak, ince parçacıkların yaklaşık yüzde 80'ini türbinlere geçebilir. Orta büyüklükteki parçacıklar için ayırma etkinliği, iki uç nokta arasında kalan parçacık boyutunun bir fonksiyonudur. Büyük miktarlarda 50 µm kadar küçük, sert, keskin parçacıklar hidrolik türbinlere zarar verebildiğinden, tasarımcıların, yoğun parçacık yüklü nehirlerde çökeltme odalarında bile (20 g/l'ye kadar pik konsantrasyona kadar) olduğunu kabul etmeleri önemlidir.

8- Bakım Yıl Hesabı

Ampirik yaklaşımlarla elde edilen bakım süresi Mavi HES'te yer alan türbinlerin bakım süresi ile karşılaştırılacaktır. Bu hesapta kullanılan ampirik yaklaşım Gummer (2009) tarafından yayımlanan makaledeki esaslara dayanmaktadır. Hesabı etkileyecek sediment miktarı hukuki yazışmalara (2020), parçacıkların cinsi, tipi (köşeli olup olmadıkları) KTÜ Jeoloji Mühendisliği çalışmasına (Temizel ve Aksoy, 2021) ve aşınmanın meydana geldiği yerler ve nedeni ise ODTÜ Mühendislik Fakültesi raporu (Ögel, 2022) ile türbinleri tamir eden şirketlerin hazırlamış olduğu durum raporlarından (Mavi HES Durum Raporu, 2020) elde edilmiştir.

Zigana Tünel inşaatından çıkan suyun bir kısmının dinlendirme havuzlarına girmeden, bir kısmının ise dinlendirme havuzuna girdiği halde havuzun çatlak ve çiroz kilidi deliklerinden akması sonucu tüneldeki ince malzemenin dereye akıtıldığı, bilirkişiler tarafından tespit edilmiştir. Dinlendirme havuzunda tutulması ve nehir yatağına verilmemesi hedeflenenler (dane çapı tanımlamasına göre) ince kum ve silt türü malzemedir. Dolayısıyla dere yatağına bırakılan malzeme; ince kum ve silt boyutundadır. Gummer (2009) türbinlerdeki asıl aşınmayı yapanın bu ince malzemeler olduğunu ortaya koymaktadır.

Dereye karışan kuvars yani silisyum miktarının da 6 kat arttığı ve bu artışın dere yatağına bırakılan çimento malzemesi ve tüneldeki delme esasında kazılardan çıkan kazı malzemeleri olduğu hukuki yazışmalarla tespit edilmiştir.

Gummer aşındırmaya sebep olacak malzemenin sertliğinin, Mohs sertlik skalasına göre 5'ten başladığını ortaya koymaktadır. Suyun içerisindeki ince malzemenin sertliği arttıkça aşınma da artmaktadır. Tablo 1'de görüldüğü üzere dere yatağındaki (6 kat artışı olan) quartz malzeme çelikten daha sert olup, aşınmayı çok etkilemektedir. Bunun yanında kum ve silt türü malzemelerin biçimi de aşınmayı etkilemektedir. Dere yatağının normalde taşıdığı malzemeler, dere yatağında (çok uzun mesafelerde) taşınması neticesinde, keskin köşelerini törpüleyerek yuvarlak hale gelir. Tünel hemen Mavi Regülatörünün membaında yani akış yukarısındadır. Bir başka deyişle, tünelden çıkan malzeme, uzun mesafelerde dere yatağında taşınmadığı için keskin köşelerini kaybetmemiştir. Bu nedenle malzemenin aşındırıcı etkisi yuvarlak malzemelere oranla 3 kat fazladır.

Hukuki raporlarda Mavi HES Projesi civarındaki kayaçlar bazalt, andezit ve kireçtaşı olarak belirlenmiştir. Andezitin sertlik skalası 5-7, bazaltın Mohs sertlik skalası 6-7, kireçtaşının sertlik skalası ise dayanıma bağlı olarak değişmekle birlikte 3-4 civarındadır (URL 1). Bu durumda andezit



ve bazaltın, Mohs skalasına göre sertliği 6,5 civarında olan çelikten sert bir malzeme olabileceği ve aşınmayı çok etkileyeceği sonucu ortaya çıkmaktadır.

Hasar gören türbinler Francis türü türbinlerdir. Francis türü türbinlerde aşınma, hızın küpüyle orantılı biçimde artarken bu oran Pelton türü türbinlerde hızın 1,5'uncu kuvveti ile artmaktadır. Hızların kuvvetlerinin oranından aynı hız için aşınmanın Francis türbinlerde Pelton türü türbinlere oranla 4 kat olduğu ortaya çıkmaktadır (Suyun hızı 2,5m/sn olarak alınabilir).

Mavi Regülatörü ve HES Projesinde akarsudan gelen alüvyon ve askı malzemesinin türbinlere ulaşmasını engellemek için 4 farklı tedbir alınmıştır. Birincisi rezervuarın hemen girişine maksimum su seviyesi altında kalacak şekilde bir tersip bendi yapılmıştır. Silt ve ince kum üzerindeki çapa ait gelen kaba malzeme bu tersip bendinde tutulmaktadır. Bu tersip bendi önünde biriken malzemenin her yıl boşaltıldığı anlaşılmaktadır. İkinci olarak yaklaşık derinliği 12 m, uzunluğu ise yaklaşık 150 m olan Mavi Regülatörü ile oluşturulan toplamda yaklaşık 63.000 m³, aktif olarak da 41.000 m³ hacme sahip rezervuar (göl, bakınız Şekil 1) yapılmıştır. Silt ve ince kum malzeme yaklaşık 63.000m³ rezervuar hacmine sahip bu gölde çökeltilmektedir. Üçüncü olarak ise su, iletim tüneline iletilmeden önce silt çökeltim havuzlarına alınmaktadır. Dördüncüsü ise hemen santral binasının üstüne gelen yerde iletim tüneli çıkışında bulunan yükleme havuzunda yapılan çökeltme işleminden sonra sular türbinlere iletilmektedir. Yapılan yol ve tünel inşaatları nedeniyle tersip bendi önünün ve rezervuarın boşaltılabilen kısmının, her yıl dolduğu anlaşılmaktadır. 2021 yılında göl alanında biriken ince malzeme yaklaşık 5000 m³'tür.

Mavi Regülatörü ve HES Projesi onaylı fizibilitesinde Mavi HES projesinde türbinlenecek akımların gerek çökeltim havuzunda gerekse yükleme havuzunda sedimentten arındırılarak türbinlere verilmesinden dolayı sediment hesabı yapılmamıştır." Yani yol inşaatları olmasaydı gelebilecek sedimentlerin büyük kısmı regülatör, silt tutma havuzu ve yükleme havuzunda tutularak türbinlere zarar vermesi engellenecekti. Ancak söz konusu inşaatların yapılmasıyla birlikte, kazı malzemelerin ve dereye verilmemesi gereken atıkların (tersip bendinin arkasından dereye bırakılması nedeniyle) her yıl yaklaşık ortalama 5000 metreküp malzeme boşaltılmaktadır. Bunun yanında yaklaşık 5000 metreküp malzeme de göl alanında birikmektedir.

Bunun yanında, dere kenarına dökülen kazı malzemelerinin yıkanması ve tünellerden çıkan ince malzemenin dereye bırakılması neticesinde, normalden çok daha ince malzeme akışa geçmektedir. Yoğun olarak 2015 yılında başlayan yol ve tünel inşaatları nedeniyle çıkan kazı malzemelerinin bir kısmı dere kenarlarında depolanmış, bir kısmı da hukuki belgelerde tespit edildiği gibi dere yatağına bırakılmıştır. Feyezan döneminde dere yatağı kenarında depolanan malzemenin, yıkanmış silt boyutundakiler göl alanında, daha büyük boyuttakiler ise tersip bendi arkasında depolanmıştır. 2017 Yılı Mart ayında temeli atılan Zigana tüneli öncesinde, Mavi Regülatörünün membaında yapılan diğer yol ve tünel inşaatları nedeniyle gelen ince silt malzeme, göl alanını minimum su seviyesine kadar doldurduğu anlaşılmaktadır (Resim 1). Göl alanında minimum su seviyesine kadar yaklaşık 22 bin m³ malzemeyi depolayabilecek alan bulunmaktadır.

Gummer (2009) tarafından yapılan çalışmada yukarıda verildiği üzere "Rezervuarlar, tüm partiküllerin üst ince boyuta kadar uzaklaştırılmasında etkilidir, ancak çökeltme havuzlarının kendi sınırlamaları vardır. Neredeyse tüm iri parçacıkları uzaklaştırmalarına rağmen, gelen konsantrasyona bağlı olarak, ince parçacıkların yaklaşık yüzde 80'ini geçebilir." tespiti yapılmıştır. Bu tespite göre rezervuarın dolmasıyla çökeltme işlemini yapılamaması nedeniyle silte (göl alanında biriken ince malzeme) karşı toplam 4 savunma hattından 2 si olan çökeltim yapısı ile yükleme havuzu kalmaktadır ki bu yapıların siltleri çökeltmekteki etkinliği %20'ye kadar düşmektedir. Bir başka deyişle, ince malzemenin %80'i (yani göl alanında toplanan 5.000 metreküpün 5 katı) olan 25.000 metreküp türbinlere ulaştığı kabul edilmiştir.

Buradan hareketle türbinlere ulaşan ince malzeme miktarı göl alanının dolmasıyla birlikte türbinlere ulaşan 25.000 metreküp malzemenin yılda gelen yaklaşık 77,35 Milyon metreküp ortalama akıma (Mavi Regülatörü Fizibilite Raporu Bölüm 1-5) oranlanarak litredeki sediment miktarının gram



olarak bulunması gerekir. Siltin (ince malzemenin) birim hacim ağırlığı 2 ton/m^3 olarak alınırsa askıda geçen toplam sediment ağırlığı yaklaşık 50.000 ton/yıl olarak bulunur.

$$\text{Askıda sediment miktarı} = 50.000.000.000 \text{ g} / 77.350.000.000 \text{ l} = 0.65 \text{ g/l}$$

Eşitlik (1)'i kullanabilmek için partiküllerin çaplarının dağılımını da bilmek gerekiyor. Aktif inşaat sahalarından ve yapılan açık kazıların taşkın sularına maruz kalması sonucu askıda taşınan malzemenin dane dağılımı, Thompson ve çalışma arkadaşları (2016) tarafından yapılan bir çalışmayla belirlenmiş olup, Şekil 13'te verilmiştir. Şekilden de görüleceği üzere askıda taşınan malzemenin yaklaşık $2/3$ 'ü $50 \mu\text{m}$ 'nin altındaki parçalardan oluşmaktadır.

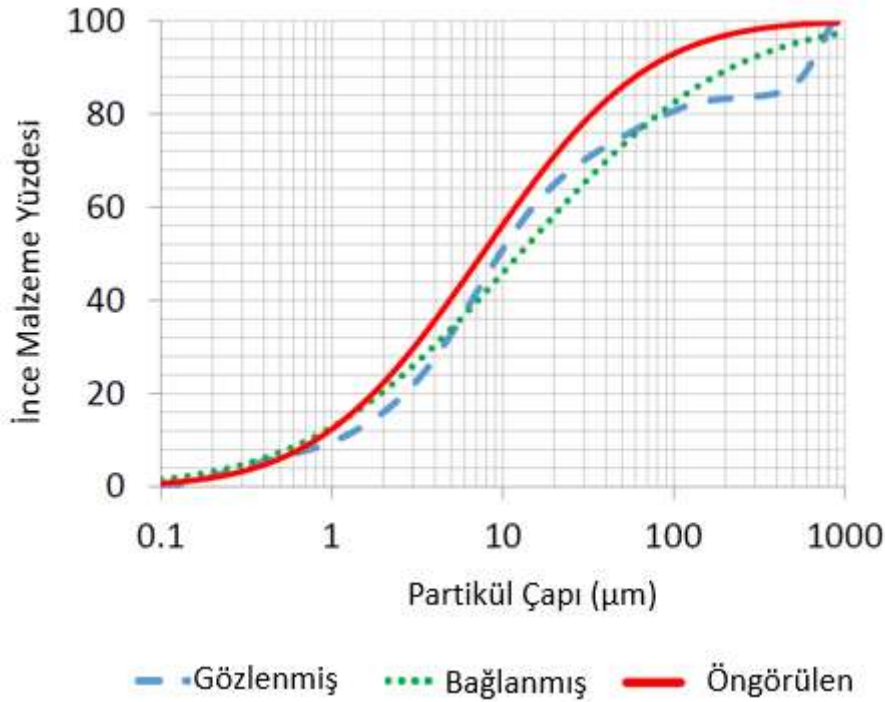

Şekil 13. İnşaat sahaları ve açık kazıların taşkın sularına maruz kalması sonucu askıda taşınan malzemenin dane dağılımı (Thompson vd., 2016)

$50 \mu\text{m}$ danelerin altı için "a" katsayısı 1, bunun üstündeki daneler için dane çapı 0.05 olarak hesap edilmektedir. $50 \mu\text{m}$ üstündeki danelerin ortalama çapı yaklaşık $100 \mu\text{m}$ olmaktadır ki bu durumda "a" katsayısı 2 olarak hesap edilebilir. Ortalama a katsayısı ise $0.66 \cdot 1 + 0.33 \cdot 2 = 1,32$ olarak hesap edilebilir.

Parçacıkların oluştuğu yer Mavi Regülatörüne çok yakın olduğu Mineralojik ve Petrografik Çalışmalara ait raporda (Temizel ve Aksoy, 2021) parçacıkların %60'ının keskin kenarlı olduğu belirtildiği için keskin kenarlı olarak tanımlanabilir. Bu durumda $k_1=1,0$ olarak Tablo 1'den alınabilir. Bütün kayaların sertliği 3'ten büyük olduğu için k_2 katsayısı 1,0 belirlenebilir. Parçalar paslanmaz çelikten (özellikle çark kısmı) inşa üretildiği için de k_3 katsayısı 1 seçilebilir. Bu durumda;

$$PE = P \times a \times k_1 \times k_2 \times k_3 = 0,65 \cdot 1,32 \cdot 1,0 \cdot 1,0 \cdot 1,0 = 0,86 \text{ olarak hesap edilebilir.}$$

PE değeri ve net düşü yüksekliği dikkate alındığında Şekil 12'de yer alan grafiğe girilirse türbinlerin 1 ila 2 yıl sürede aşınacağı sonucuna varılabilir (Yılmaz ve Çamdalı, 2022). 2020 Yılında tamirata alınan türbinler gelen sedimentlerden dolayı tam 20 ay sonra tekrar bakıma alınmıştır. Bu durum hem ampirik yaklaşımdaki doğruluğu hem hesaba giren parametrelerdeki isabeti ortaya koymaktadır.



9-Sonuçlar

Mavi Regülatörünün membaında yapılan yol ve tünel inşaatları nedeniyle yapılan açık kazılar ve dere kenarında depolanan kazı malzemelerinin hem yağmur ve taşkın sularının etkisiyle taşınması hem de taşınan malzemelerin içerisinde yer alan ince taneli keskin kenarlı parçacıkların dinlendirme havuzlarında tutulup uzaklaştırılmaması sonucunda söz konusu malzemeler regülatör göl alanını doldurmuştur. Gelen bu sedimentlerin çapı 1 mm'den büyük olanlar, gölün girişinde yer alan tersip bendinin arkasında tutulmasına rağmen askıda olanlar göl alanına ulaşmıştır. Mavi Regülatörü göl alanı inşaat safhasında temizlenerek minimum su seviyesi altında 22.000 metreküplük bir hacim oluşturulmuş olduğu, gelen sedimentler ile göl alanının dolduğu anlaşılmaktadır. 2019 ve 2020 yıllarında da boşaltma işlemi yapılmaya çalışılmıştır. En son 22 Kasım 2021 tarihinde yapılan boşaltma işleminde ise yaklaşık 2500 metreküp malzeme boşaltılmış ve aradan 6 aydan az süre geçmesine rağmen gölalanı tekrar dolmuştur. Gölalanı askıdaki malzemelerin çökeltilmesi açısından, çökeltme havuzu ve yükleme havuzuna göre çok daha iyi çalışmaktadır. Ancak dolduğu ve boşaltılmadığı için askıdaki malzeme türbinlere gitmektedir. Türbinlere giden malzeme de büyük aşınmalara yol açmaktadır. Türbinlerden alınan resimler aşınmanın boyutunu ortaya koymaktadır. Detayları açıklanan hesaplarda türbinlerin 1-2 yıl arasında bakıma girmesi gerektiğini ortaya koymuştur. Gerçekte ise türbinler yaklaşık 20 ay içerisinde ikinci kez tamire alınmak zorunda kalmıştır. Bu durum Gummer (2009) tarafından geliştirilen ampirik hesapların iyi sonuçlar verdiğini göstermektedir. Bunun yanında Gummer'ın da (2009) belirttiği gibi türbin parçalarındaki bu aşınmalar kaçınılmaz olarak türbin verimlerini azaltacaktır.

10-Referanslar

- 1) D Felix, I Albayrak, A Abgottspon and R M Boes (2016). Hydro-abrasive erosion of hydraulic turbines caused by sediment - a century of research and development. 2016 *IOP Conf. Ser.: Earth Environ. Sci.* 49 122001. (<https://iopscience.iop.org/article/10.1088/1755-1315/49/12/122001>, 8 Mayıs 2021 tarihinde en son erişildi.)
- 2) Gummer, J.H., "Combating Silt Erosion in Hydraulic Turbines," *HRW-Hydro Review Worldwide*, Volume 17, No. 1, March 2009, pages 28-34.
- 3) Hukuki Yazışmalar (2020). Maçka Sulh Hukuk Mahkemesine 2020/4 D. dosyası kapsamında tespit davası kapsamında yapılan yazışma tespit ve bilirkişi raporları.
- 4) Karakaya Regülatörü ve HES Projesi Fizibilite Raporu (2012).
- 5) Mavi HES Durum Raporu (2020).
- 6) Mavi Regülatörü ve HES Projesi Fizibilite Raporu (2010).
- 7) Mavi Regülatörü ve HES Projesi Kati Projeleri (2012).
- 8) Temizel, İ. ve Aksoy, H. (2021) Mavi Regülatörü Göl Alanına Gelen Malzemelerin Mineralojik ve Petrografik Çalışmaları. KTÜ Jeoloji Mühendisliği Bölümü (Eylül).
- 9) Thompson, J., Sattar, A.M.A., Gharabaghi, B., Warner, R.C., (2016) Event-Based Total Suspended Sediment Particle Size Distribution Model, *Journal of Hydrology*.
- 10) Ögel, B. (2022). ODTÜ Mühendislik Fakültesi uzman raporu Kod No: 2022-03-08-1-00-004, 30.Ocak.2022.
- 11) URL1. <https://www.eski-eser.com/tas-islerinde-islenebilirlik-zammi-hesabi>, (en son 10 Şubat 2022 tarihinde ulaşılmıştır).
- 12) URL2. <https://www.erciyeskoleji.com/images/sayfa/files/8-fenbeg%20o%CC%88rne%20sorular.pdf> en son 27.11.2022 tarihinde erişilmiştir.



INTERNATIONAL ASIAN CONGRESS ON CONTEMPORARY SCIENCES – VII

- 13) URL3. <https://www.haberturk.com/yeni-zigana-tuneli-insaatinda-yuzde-78-seviyesine-ulasildi-2897450-ekonomi> (3 Şubat 2022 tarihinde ulaşılmıştır).
- 14) Yılmaz, D. ve Çamdalı, Ü. (2022). Mavi Regülatörü ve HES ile Köprüyanı Regülatörü ve HES Projelerinin Türbinlerinde Meydana Gelen Aşınmaların Değerlendirilmesi ile İlgili Rapor.
- 15) Zu-Yan, M., (1996). “Review of Research on Abrasion and Cavitation of Silt Laden Flows through Hydraulic Turbines in China,” 18th IAHR Symposium on Hydraulic Machinery and Cavitation,” International Association of Hydraulic Engineering and Research, Valencia, Spain, 1996.



3B YAZICI İLE BASKILANAN HARÇ KATMANLARININ TERMAL ÖZELLİKLERİNİN İNCELENMESİ

Tayfun Uygunođlu

0000-0003-4382-8257

Feyza Çetingöl

0000-0002-7750-0850

Barış Şimşek

0000-0002-0655-4368

Semahat Doruk

0000-0001-8476-2544

Afyon Kocatepe Üniversitesi, Mühendislik Fakültesi, İnşaat Mühendisliği Bölümü, Afyonkarahisar, Türkiye
Çankırı Karatekin Üniversitesi, Mühendislik Fakültesi, Kimya Mühendisliği Bölümü, Çankırı, Türkiye

Özet

Bu çalışmada günümüz çağında popüler olan üç boyutlu (3B) yazıcı ile üretilen yapıların beton katmanları arasındaki aderans dayanımı ve termal performansı deneysel olarak incelenmiştir. Bu amaçla, laboratuvar ortamında 3B yazıcıda harç kullanılarak 400x400x200 mm boyutlarında bir kutu eleman basılmıştır. Harcın hazırlanmasında, 0,37 su/çimento oranı ve en büyük tane boyutu 0,5 mm agrega kullanılmıştır. Öncelikle harcın işlenebilirliği yayılma tablasıyla belirlenmiştir. Harç 20 mm genişliğinde katmanlar halinde yazdırılmıştır. Yazdırılma işleminden sonra 3, 7 ve 28. günlerde aderans deneyi yapılarak katmanlar arası bağ dayanımları incelenmiştir. Eklemeli imalatla baskılanmış kutu elemanın içerisine 50 W'lık bir ampul yerleştirilmiş ve bir ısı kaynağı oluşturulmuştur. Kutu elemanın alt ve üst bölümleri yalıtılarak, ısı kaynağı belli bir süre çalıştırılmıştır. Bu sırada hem iç hem de dış ortam ve eleman yüzey sıcaklıkları termokuplarla ölçülmüştür. Kutu elemanın yüzeyindeki sıcaklık dağılımları ayrıca termal kamera ile izlenmiştir. Aynı harçla klasik üretim yöntemiyle de plakalar hazırlanarak aynı boyutlarda bir kutu eleman daha hazırlanmış ve 3B yazdırılan eleman ile termal performansları karşılaştırılmıştır. Elde edilen sonuçlara göre, kür süresine bağlı olarak katmanlar arası bağ dayanımı artmıştır. Eklemeli imalat yöntemiyle üretilen elemanlarda katmanlar arasından az da olsa ısı kayıpları termal kamera ile gözlenmiştir.

Anahtar Kelimeler: Eklemeli imalat, bağ dayanımı, termal performans.



INVESTIGATION OF THE THERMAL PROPERTIES OF MORTAR LAYERS PRINTED WITH A 3D PRINTER

Abstract

In this study, the adhesion strength and thermal performance of the structures produced with the popular three-dimensional (3D) printer in today's age were investigated experimentally. For this purpose, a box element of 400x400x200 mm was printed using mortar in a 3D printer in a laboratory environment. In the preparation of the mortar, 0.37 water/cement ratio and 0.5 mm aggregate with the largest particle size were used. First of all, the workability of the mortar was determined by the spreading table. The mortar was printed in layers that were 20 mm wide. An adherence test was conducted after the printing process to assess the bond strengths between the layers on the third, seventh, and 28th days. A 50 W light bulb was placed inside the additively built box part to operate as a heat source. The lower and upper parts of the box element were insulated, and the heat source was operated for a certain time. Meanwhile, both indoor and outdoor ambient and element surface temperatures were measured with thermocouples. A thermal camera was also used to monitor the temperature distributions inside the box element. Plates were made using the same mortar and traditional production techniques, and a box element with the same dimensions was also made. The thermal performances of these two elements were compared to those of the 3D-printed element. The obtained results showed that layer's bond strength increased with curing time. In the elements produced by the additive manufacturing method, the heat losses between the layers were observed with a thermal camera.

Keywords: Additive manufacturing, bond strength, thermal performance.

1. GİRİŞ

Eklemeli imalat günümüzde farklı tipte malzemeler kullanılarak dijital ortamda tasarlanmış olan modelleri 3B yapı olarak üretebilen bir teknolojidir. Hızlı bir üretim tekniği olması, karmaşık yapıların kolaylıkla üretilebilmesi, hata oranının az olması ve malzeme israfının en aza indirilmesi sebebi ile çeşitli sektörlerde yaygın olarak kullanılmaktadır (Yang vd., 2019). 3B baskı gelişen teknolojisi ile inşaat sektöründe geleneksel imalatın işleyişini değiştirmektedir. Günümüzde insanlar genel olarak zamanlarının %90'dan fazlasını iç mekânlarda geçirmektedir. Binalar dünyadaki toplam enerji tüketiminin %40'ını oluşturmaktadır ve enerji tüketimine katkı sağlayan ana sektör olarak kabul edilmektedir (E. Commission, 2019). Yapı sektörünün çevreye verdiği zarar göz ardı edilemeyecek kadar fazladır, ancak 3B baskı teknolojisi bu oranı ciddi miktarlarda azaltmaktadır bu da daha verimli ve sürdürülebilir bir imalata doğru ilerlemektedir (Ebrahimi vd., 2022). Geleneksel üretim ile karşılaştırıldığında 3B üretim şekli inşaatın maliyetini, zamanını, işçilik ve kalıp maliyetlerini azaltmakta, malzeme israfını önlemekte ve karmaşık geometrideki yapıların üretiminde kolaylık sağlamaktadır (Sun vd., 2021). Eklemeli imalat veya 3B baskı eksiltmeli imalat ve biçimlendirici üretimin aksine, genellikle üst üste katmanların birleştirilme sürecidir (Standard Terminology for additive manufacturing, 2015). Eklemeli imalat yöntemi ile yapılar birbirinden benzersiz şekillerde üretilebilmektedir. Ekstrüzyona dayalı 3B baskı, beton filamentini ekstrüzyonun çıkış ucundan 3B yazıcıya bağlanır ve burada yazıcı nozulundan ekstrüde edilir. Böylece daha öncesinde tanımlanmış bir üç boyutlu modelin katman katman yazdırılma işlemi başlamış olur (Buswell vd., 2007). Eklemeli imalat yöntemi ile üretilecek yapıların üretim aşamasında katmanlar birbiri üzerine gelen yükü taşıyabilmelidir. Geçtiğimiz yıllarda birçok çalışma 3B yapıların fizibilitesini geliştirmek ve kullanılan harç özelliklerini iyileştirmek üzerinedir.



3B baskı bileşenlerinin işlenebilirlikleri, ekstrüde edilebilirlik, yazdırılabilirlik özellikleri ve ayrıca ilgili mekanik özellikleri, öncelikli olarak araştırmaların ana konusu olmuştur. Buna karşılık, 3B binaların termal performansına daha az incelenmiştir. Aslında, eklemeli imalat yöntemi ile inşa edilen binaların dayanımları yanı sıra yaşanabilir ve enerji veriminin iyi olması da gerekmektedir.

Konu ile ilgili olarak literatürde, Sun vd. (Sun vd., 2021) 3B baskı beton bir binanın termal performansını kızılötesi termografi tekniği ile incelemiştir. Bu tekniği kullanarak potansiyel kusurların tespitini gerçekleştirmiştir. Sonuç olarak evin dış duvar yüzeyinde, baskı yolu ve enine kesit tasarımındaki farklılıklardan kaynaklanan oldukça düzensiz bir sıcaklık dağılımı tespit etmişlerdir. Lowke vd. (Lowke vd., 2018) 3B yapılarda termal iletkenliğin düşük olduğu bölgelerde oyuklar açmanın yalıtımı daha iyi sağlayacağını belirtti. Bu yaklaşımla farklı termal performans seviyelerine sahip bölgelerin yapısal bölgeler halinde düzenlenebileceğine dikkat çekmiştir. Robati vd. (Robati vd., 2016) eklemeli imalat ile üretilen yapıların farklı karışım tasarımlarının termal performansına etkisini araştırmışlardır. Sonuç olarak betonun karışım tasarımını değiştirmesi sonucunda termal performansında ciddi değişiklikler olduğunu ortaya koymuşlardır. Prasittisopin vd. (Prasittisopin vd., 2020) 3 farklı basınç dayanıma sahip harçlarla 3B olarak ürettiği duvar panellerinin ısı yalıtım performanslarını incelemiştir. 3B baskı harcının yoğunluğunun ısı yalıtımını doğrudan etkilediği sonucunu ulaştırmıştır. Daha hafif yoğunluğa sahip düşük mukavemetli harçtan yapılan 3B baskılı panel, daha iyi ısı yalıtım performansı gösterdiği sonucuna ulaşmışlardır.

Bu çalışmada, farklı üretim teknikleri kullanılarak iki adet kutu eleman oluşturulmuştur. Eklemeli imalat yöntemi ve standart kalıplı üretim yöntemi kullanılmıştır. Daha sonra bu iki kutu elemanın içerisine ısı kaynakları yerleştirilmiş, termal özellikleri termal kamera ve termokupllar yardımı ile incelenmiştir. İki farklı yöntem kullanılarak üretilen kutu elemanların termal iletkenlik sonuçları karşılaştırılmıştır.

2. MATERYAL VE METOT

2.1 Materyal

Yazdırılabilir harç üretiminde 0,37 su/çimento oranı sabit tutulmuştur. Beton üretiminde bağlayıcı olarak TS EN 197-1 (2012)'e uygun CEM I 42,5 R Portland çimentosu kullanılmıştır ve özellikleri Tablo1'de verilmiştir. Agrega olarak özgül ağırlığı 2,64 ve en büyük tane boyutu 0,5 mm olan silis kumu ve 0-2 µm silis tozu kullanılmıştır. Karışım suyu olarak içme suyu, kimyasal katkı olarak su azalıcı özelliği olan MasterGlenium 51 %0,4 oranında kullanılmıştır. Kimyasal katkı özellikleri Tablo2 'de verilmiştir.



Tablo 1. CEM I 42,5 R Portland çimentosu kimyasal analiz sonucu.

Bileşen, %	Çimento
CaO	63,6
SiO ₂	16,6
Al ₂ O ₃	4,72
Fe ₂ O ₃	3,27
MgO	1,91
Na ₂ O	0,34
K ₂ O	1,06
SO ₃	4,72
Özgül ağırlık	3,07
İncelik (Blaine), cm ² /g	3312

Tablo 2. MasterGlenium 51 teknik özellikleri.

Malzemenin Yapısı	Polikarboksilik Eter Esaslı
Görünüm	Kahverengi- sıvı
Özgül ağırlık (20°C'de)	1,082 – 1,142 kg/lt
pH değeri	6 – 7
Alkali içeriği (%)	≤ 3,00 (ağırlıkça)
Klor iyon içeriği (%)	≤ 0.10 (ağırlıkça)
Korozyon davranışı	Sadece EN 934-1:2008, EkA.1'de verilen bileşenleri kapsar
Tehlikeli maddeler	Tamamen Ek-AZ' ye uygundur

2.2 Metot

İlk olarak çimento hamuru hazırlanmıştır. Harcın bileşiminde bağlayıcı olarak 750 kg/m³ Portland çimentosu 225 kg/m³ silis kumu ve 225 kg/m³ silis tozu kullanılmıştır ve 0,37 su/çimento oranına göre içme suyu ilave edilmiştir. Kimyasal katkı MasterGlenium 51 %0,4 oranında ilave edilmiştir. Çimento hamurunun işlenebilirlik ve yazdırılabilirlik kontrolü için taze hal deneyi olan yayılma tablası deneyi yapılmıştır. Bu deney ile çimento hamurunun yayılma özellikleri belirlenmiştir. Öncelikle taze harç yayılma tablası konisine doldurulmuştur (Şekil 1-a), daha sonra koni tablaya dik yönde çekilerek tablanın darbe kolu ile 15 vuruş yapılmıştır. Çimento bazlı harç yayıldıktan sonra (Şekil 1-b), birbirine dik iki çap ölçülmüş ve değerlerin aritmetik ortalaması alınmıştır.

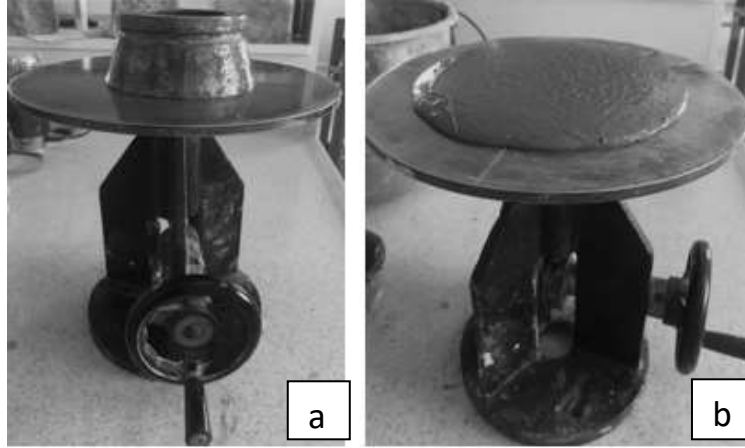

Şekil 1. (a) Yayılma tablası düzeneği, (b) yayılmış haldeki harç.

İşlenebilirlik özelliği belirlendikten sonra taze harç yazdırılabilir hale gelmiştir. Daha sonra 3B yazıcı ile 400x400x200 mm boyutlarına sahip bir kutu eleman basılmıştır. Basılma aşamasında hazırlanan harç 3B yazıcıyı beslemek için kullanılan ekstrüzyon cihazına doldurulmuş ve yazdırma işlemi gerçekleştirilmiştir (Şekil 2-a). 3B yazıcının harç çıkış ucu dairesel kesitli bir uç olup 20 mm çapındadır.

Yazdırma işlemi tamamlandıktan sonra 3, 7 ve 28. günlerde üst üste gelen katmanların aderans dayanımları yani katmanlar arası bağ dayanımları incelenmiştir. Aderans deneyi için laboratuvar ortamında bir düzenek hazırlanmıştır (Şekil 2-b) ve numuneler 3, 7 ve 28 günlük kür sürelerini tamamladıktan sonra katmanlar arası bağ dayanımları ölçülmüştür. Her bir kür zamanında en az 5 numuneye uygulanmış ve bulunan değerlerin ortalamaları alınmıştır.

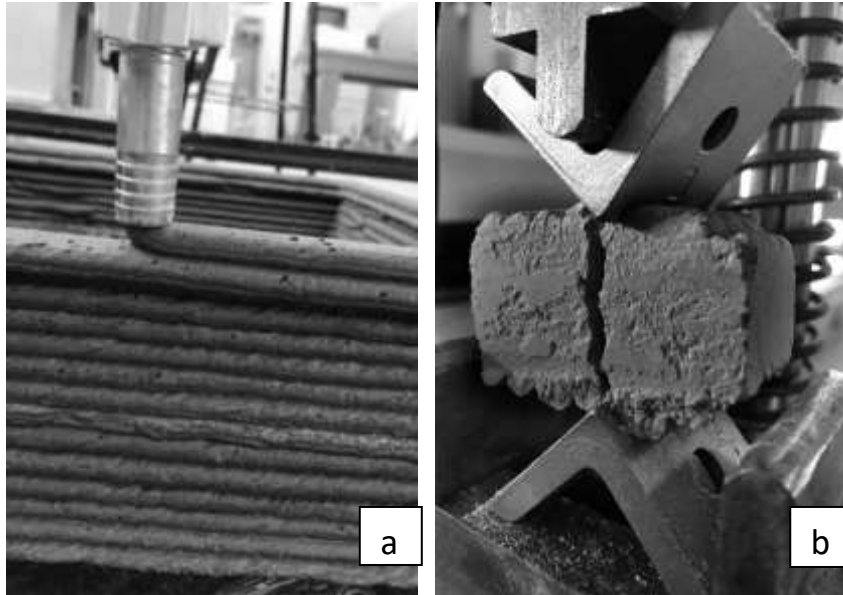

Şekil 2. (a) Kutu eleman yazdırılma aşaması. (b) Aderans deney düzeneği ve uygulaması,

Diğer bir yandan 400x400x200 mm ebatlarında kutu eleman yazdırılmıştır. 28 günlük kür süresini tamamladıktan sonra kutu elemanın alt ve üst yüzeyi köpük kullanılarak yalıtılmıştır, daha sonra içerisine bir duy yerleştirilmiştir ve 50W'lık bir ampul kullanılarak ısı kaynağı oluşturulmuştur. Daha sonra kutu elemanın iç ortamına, dış ortama, iç yüzeylerine ve dış yüzeylerine termokupullar



yerleştirilmiştir (Şekil 3-a). Burada amaç kutu elemanın duvarlarından ısı akışının zamanla ne kadar olduğunu bulmaktır. Kutu içerisindeki ısı kaynağı datalogger ile eş zamanlı kayıt başlatılarak bir saat çalıştırılmıştır. Daha sonra kutu içerisi ve dış ortam sıcaklığı birbirine eşitlenene kadar soğuması beklenmiştir, bu esnada veriler kaydedilmeye devam etmiştir. Bu ölçümler yapılırken kutu dış yüzeyinden termal kamera ile farklı açılardan görüntüler alınmıştır (Şekil 3-b).

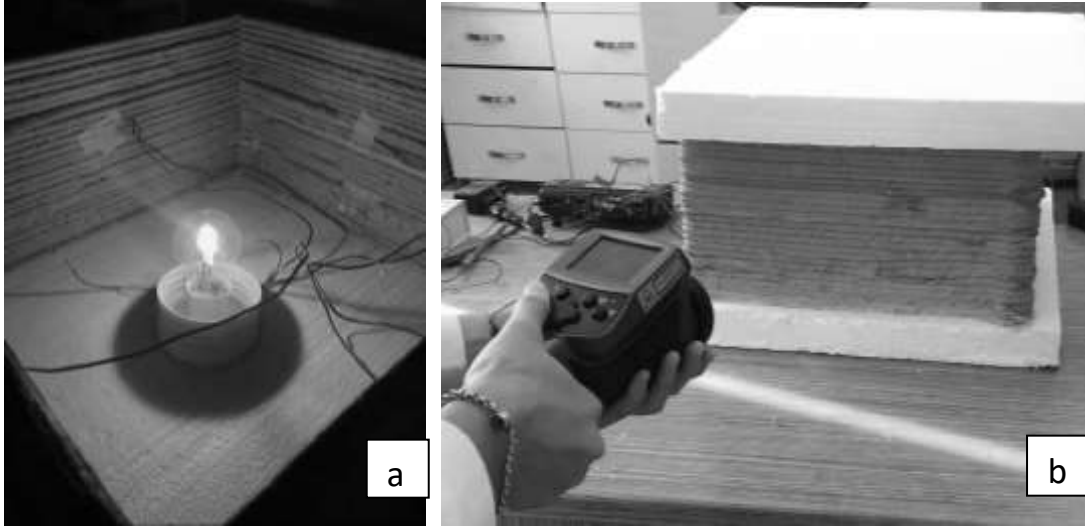

Şekil 3. (a) yazdırılmış kutu içerisindeki ısı kaynağı ve termokuplların yerleştirilmiş görüntüsü, (b) termal kamera ile görüntü alma aşaması.

Aynı çimentolu harç karışımı kullanılarak kalıp kullanılarak klasik üretim yöntemi ile aynı boyutlarda plakalar dökülmüştür (Şekil 4-a). 400x400x200 mm boyutlarında bir normal döküm kutu oluşturulmuştur (Şekil 4-b), 28 günlük kür süresi tamamlandıktan sonra, yazdırılmış kutu elemanda yapılan bütün işlemler normal döküm kutu elemanda da uygulanmıştır. Kutunun alt ve üst kısmı köpük ile yalıtılmıştır.

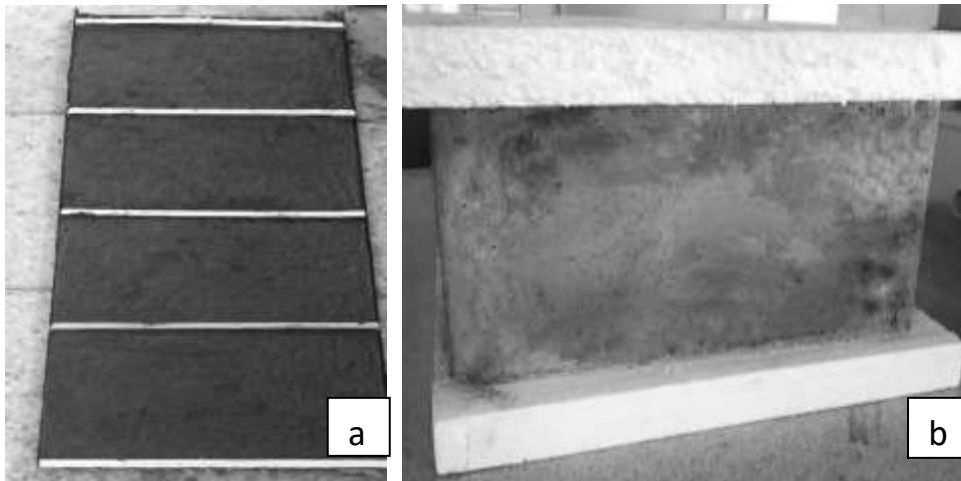

Şekil 4. (a) Standart kalıplı döküm uygulaması ile plaka dökümü, (b) standart döküm kutu elaman.



Daha sonra içerisine bir duy yerleştirilmiş ve 50W'lık bir ampul ile ısı kaynağı oluşturulmuştur. Standart döküm kutu elmanın iç ortamına iç duvarlarına dış duvarlarına ve dış ortamına termokupllar yerleştirilmiştir. Isı kaynağı bir saat çalıştırılırken datalogger kullanılarak veriler kaydedilmeye başlanmıştır. Bir saat sonunda ısı kaynağı kapatılmıştır ve kutu içi ve dışı aynı sıcaklığa ulaşana kadar veri alınmaya devam etmiştir. Bu işlem her iki farklı kutu elemanda bir haftadan fazla süre uygulanmıştır. Elde edilen sonuçlar birbiri ile kıyaslanmıştır.

3. BULGULAR

Çimento harcı 0,37 su/çimento oranında hazırlanmıştır. Daha sonra yayılma tablası deney yapılmıştır, elde edilen değerlerin ortalaması alınmıştır ve taze harcın yayılma çapı ortalama olarak 192,5 mm ölçülmüştür. Yazdırılabilirlik açısından taze harç için yayılma tablası deneyi önemli bir parametredir.

Eklemeli imalat yöntemi ile üretilen yapıların katmanlar arası bağ dayanımları önem teşkil etmektedir. Yazdırılmış katmanlar arası bağ dayanımları Şekil 5'te verilmiştir. Bağ dayanımı birbiri üzerine yazdırılan katmanların aderans dayanımlarını ifade etmektedir. Bağ dayanımı kür süresi ile doğru orantılı olarak artmaktadır, yazdırma işleminden sonraki günlerde katmanlar arası dayanım ilk günlerde bariz bir artma görülmüştür fakat 7 ve 28 gün arasında dayanım artma hızı yavaşlamıştır. 28 günlük kür süresi tamamlandığında bağ dayanımı maksimum seviyeye ulaşmıştır.

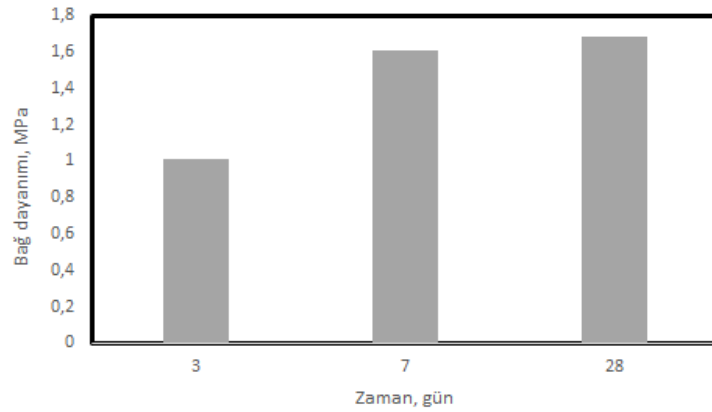

Şekil 5. Farklı kür sürelerindeki katmanlar arası bağ dayanımları.

Termal kamera ile alınan fotoğraflar (Şekil 6-a, b) analiz edilmiştir. Her iki kutu fotoğrafının üzerine birer çizgi çekilerek, çizgi boyunca görülen sıcaklıklar grafik olarak Şekil 7'de verilmiştir. Grafikteki çizgi boyunca aşağı inildikçe sıcaklığın azalma nedeni bizim ısı kaynağımızın kutu altında bulunması ve ısınan havanın yükselmesinden kaynaklanmaktadır. Grafikteki 3B kutu verilerindeki iniş çıkışların nedeni yazdırılan kutu elamanın katmanlar halinde olmasıdır. Bu katmanların yüzeyindeki sıcaklık ve katmanların birleşme noktasındaki yani katman aralarındaki sıcaklığın farklı olmasından kaynaklanmaktadır. Yani 3B yapıların az da olsa katman aralarından ısı kaybı yaşadıkları söylenebilir.

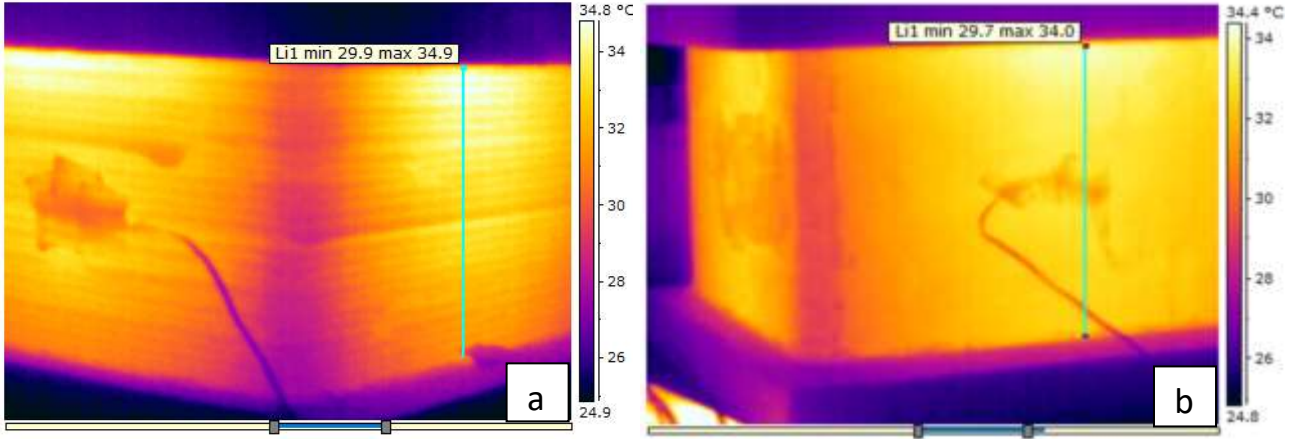

Şekil 6. (a) 3B baskı ile üretilen kutu elamanın termal kamera görüntüsü, (b) klasik yöntem ile üretilen kutu elaman termal kamera görüntüsü.

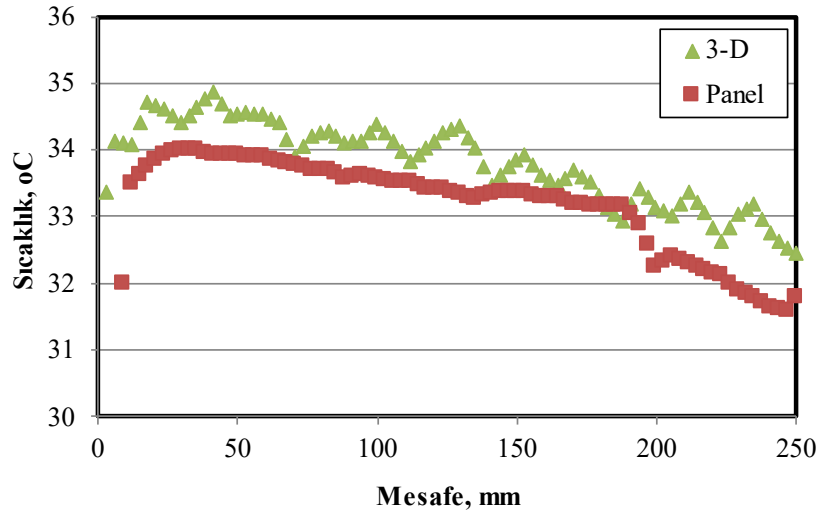

Şekil 7. Kutu elamanların çizilen çizgi üzerindeki sıcaklık değişimleri.

Datalogger üzerinden alınan sıcaklık verileri Şekil 8 ve Şekil 9’da verilmiştir. 3B baskı ile üretilen kutu iç duvar ve dış duvar sıcaklıklarına bakıldığı zaman aradaki fark %6,6 iken, klasik kutu elemana bakıldığında bu farkın %14,2 olduğu görülmektedir. İç ve dış duvar sıcaklıklarının yakın olması 3B kutu elemanın katmanlar arasından ısı kaybettiğini göstermektedir.

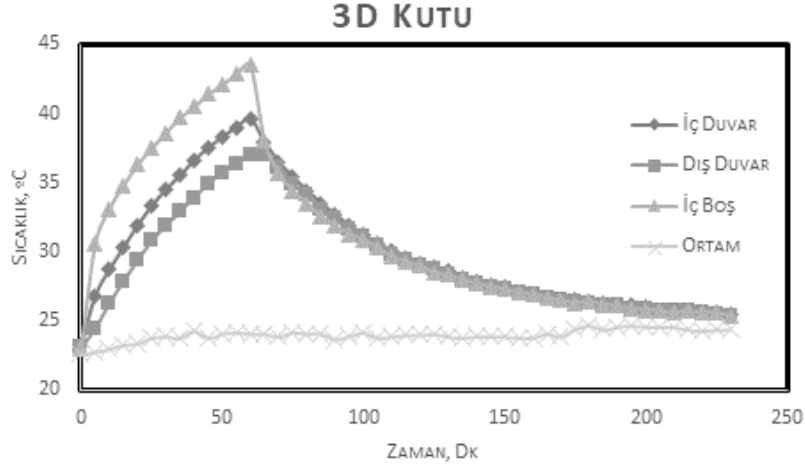

Şekil 8. 3B baskı ile üretilen kutu elemanın datalogger ile alınan verileri.

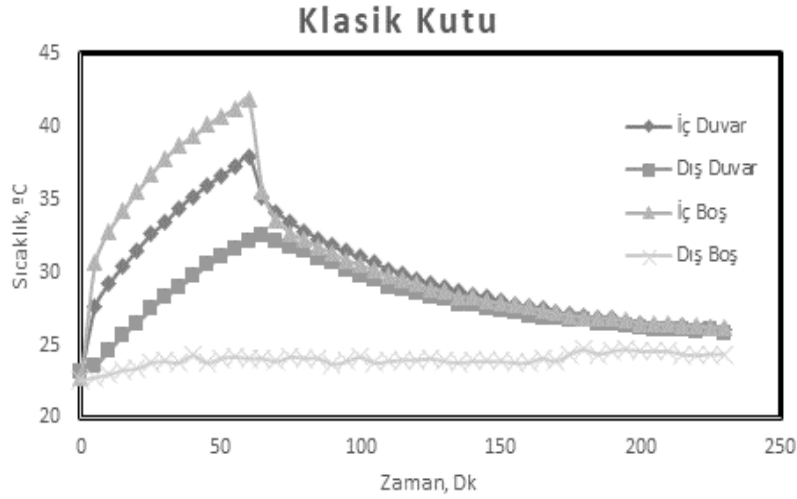

Şekil 9. Klasik yöntem kullanılarak üretilen kutu elemanın datalogger ile alınan verileri.

4. SONUÇLAR

Sonuç olarak bu çalışmada, literatür eksikliğini gidermek için bir 3B kutu eleman ve klasik bir kutu eleman üretilerek her iki üretim tekniği üzerinde termal özellikler incelenmiş ve kıyaslamalar yapılmıştır. Termal özelliklerin sıcaklık ve ısı akışının izlenmesi sonucunda, test edilen 3B kutu elemanın ısı yalıtım özelliklerinin yetersiz olduğunu görülmektedir.

- Taze hal özelliği olan yayılma çapı, yazdırılabilir bir harç için ideal bir değerdir.
- Katmanlar arası bağ dayanımı kür süresi ile doğru orantılı olarak artmaktadır. 7 ve 28 günlük arada dayanım artışı yavaşlamıştır ve 28. günün sonunda maksimum dayanıma ulaşılması beklenmektedir.
- Termal kamera ile alınan görüntüler incelendiği zaman 3B baskı ile üretilen kutu elemanın katmanlar arasından az da olsa ısı kaybettiği görülmektedir.
- Datalogger ile alınan veriler ve termal kamera verileri birbirini destekler niteliktedir. Klasik döküm kutuya göre 3B baskı ile üretilen kutu eleman %46 oranında daha fazla ısı kaybetmektedir.



Sonuç olarak 3B üretim şeklinin, geleneksel yöntemle göre çevreye verdiği zarar çok düşüktür. Üretim süresini ve malzeme israfını minimuma indirmektedir. Fakat termal özellikleri geleneksel binalara nazaran daha düşüktür. 3B yapılarda termal özelliklerin iyileştirilmesine ihtiyaç duyulmaktadır.

5. TEŞEKKÜR

Bu makalede, 221M784 numaralı projemize verdiği destekten dolayı Tübitak'a teşekkür ederiz.

6. KAYNAKLAR

- [1] Buswell R.A., Soar R.C., Gibb A.G.F., Thorpe A., (2007). Freeform Construction: Mega-scale Rapid Manufacturing for construction, *Automation in Construction*, 16(2), 224-231.
- [2] E. Commission, Clean energy for all Europeans package, 2019.
- [3] Ebrahimi M., Mohseni M., Aslani A., Zahedi R., (2022). Investigation of thermal performance and life-cycle assessment of a 3D printed building, *Energy and Buildings*, 272.
- [4] Lowke D., Dini E., Perrot A., Weger D., Gehlen C., Dillenburger B., (2018). Particle-bed 3D printing in concrete construction – Possibilities and challenges, *Cement and Concrete Research*, 112, 50-65.
- [5] Prasittisopin, L., Pongpaisanseree, K., Jiramarootapong, P., Snguanyat, C. (2020). Thermal and Sound Insulation of Large-Scale 3D Extrusion Printing Wall Panel. In: Bos, F., Lucas, S., Wolfs, R., Salet, T. (eds) *Second RILEM International Conference on Concrete and Digital Fabrication. DC 2020, RILEM Bookseries*, vol 28. Springer, Cham.
- [6] Robati M., McCarthy T.J., Kokogiannakis G., (2016). Incorporating environmental evaluation and thermal properties of concrete mix designs, *Construction and Building Materials*, 128, 422-435.
- [7] Standard Terminology for additive manufacturing (2015). -general principles- Terminology, I. A. 52900-15.
- [8] Sun J., Xiao J., Li Z., Feng X., (2021). Experimental study on the thermal performance of a 3D printed concrete prototype building, *Energy and Buildings*, 241.
- [9] TS EN 197-1, (2012). Cement- Stage 1: General Cements – Component, TSE, Ankara Turkey.
- [10] Yang S., Wi S., Park J.H., Cho H.M., Kim S., (2019). Novel proposal to overcome insulation limitations due to nonlinear structures using 3D printing: Hybrid heat-storage system, *Energy and Buildings*, 197, 177-187.



INVESTIGATION OF MELTING BEHAVIOR OF CHEESE PRODUCED WITH BY-PRODUCTS FROM BUTTER

Halil Riza Avcı

Tulay Ozcan

Bursa Central Research Institute of Food and Feed Control, Osmangazi, Bursa, Turkey

Orcid:0000-0002-6393-4914

Bursa Uludag University, Faculty of Agriculture, Department of Food Engineering, Bursa, Turkey,

Orcid: 0000-0002-0223-3807

Abstract

Butter by-products are wastes from dairy industry processes that contain high levels of nutritionally rich and health-promoting nutraceutical compounds such as milk fat globule membrane (MFGM), phospholipids and biologically active peptides. These compounds have anti-carcinogenic, anti-diabetic, anti-cholesterolemic, anti-oxidant, anti-microbial activities and health effects. In addition to its functional benefits, buttermilk as a by-product of butter production draws attention with its use in various dairy products with its protein fortification, emulsification and textural modification effect. The aim of this study is to investigate the melting behavior of traditional pasta-filata cheeses produced with buttermilk. It was determined that the addition of buttermilk in cheeses increased the resistance to extension but decreased the Schreiber meltability value and this changed according to the added ratio. In conclusion, buttermilk can be used in cheese and different food formulations in place of skim milk powder for reduction of fats and flavor-texture enhancing ability.

Keywords: Butter milk, Cheese, Schreiber meltability



FLEXIBLE STRAIN SENSORS FROM CARBONIZED PISTACHIO SHELL WASTES

Hatice Aylin Karahan Toprakci

Mukaddes Sevval Cetin

Aybuke Sultan Demirel

Ozan Toprakci

Yalova University, Engineering Faculty, Department of Polymer Materials Engineering, Yalova, Turkey.

Yalova University, Institute of Graduate Studies, Yalova, Turkey.

Abstract

In this work, a conductive polymer composite was prepared and used as a flexible, piezoresistive strain sensor. Flexible thermoplastic elastomer, poly[styrene-b-(ethylene-co-butylene)-b-styrene] (SEBS), was used as the matrix and carbonized pistachio shell wastes were used as the conductive carbon. The composites were prepared by the combination of solvent casting and compression molding. Strain sensing performance was evaluated by a four-point resistance measurement kit and mechanical testing system under cyclic loading. Carbonized pistachio shell waste filled flexible composite was found to be sensitive to applied strain.

Keywords: Pistachio shell, carbonization, thermoplastic elastomers, flexible electronics, strain sensors

KARBONİZE EDİLMİŞ ANTEP FISTIĞI KABUKLARINDAN ELDE EDİLEN ESNEK UZAMA SENSÖRLERİ

Özet

Bu çalışmada, iletken bir polimer kompozit hazırlanmış ve esnek, piezorezistif uzama sensörü olarak kullanılmıştır. Esnek termoplastik elastomer, poli[stiren-b-(etilen-ko-bütülen)-b-stiren] (SEBS), matris olarak, karbonize edilmiş antep fıstık kabukları ise iletken karbon olarak kullanılmıştır. Numune, çözültiden dökme ve basınç altında kalıplama teknikleri ile hazırlanmıştır. Uzama sensor performansı dört proflu direnç ölçüm kiti ve mekanik test sistemi ile çevrimsel uzama koşulları altında yapılmıştır. Karbonize edilmiş antep fıstık kabuklarından elde edilen esnek kompozitin uzama deformasyonuna karşı hassas olduğu belirlenmiştir.

Anahtar Kelimeler: Antep fıstığı, karbonizasyon, termoplastik elastomerler, esnek elektronikler, uzama sensörleri

INTRODUCTION

Pistacia vera, known as pistachio, is an edible fruit with high level of nutrition. It consists of fruit, skin, and shell. Nearly 50 wt% of the fruit is hard shell. This part of the fruit has not been industrially evaluated, so it is the agricultural waste. Based on the statistics, the total pistachio shell waste is estimated to be around 80000 MT in 2020 in Turkey (FAO 2020). The consideration of



pistachio shell wastes for industrial applications can be a sustainable solution to this waste problem. As known, recent economic crisis in the raw material market has been spreading to all sectors. Both academia and industry have been looking for sustainable solutions for raw materials. In the case of sustainable raw materials, renewability is of great importance. Since pistachio is a renewable fruit, its shell is also counted as renewable. It can be used as a filler for polymer composites (Alsaadi, Erklig, and Albu-khaleefah, 2018)(Celik et al., 2020) or combustion (da Silva et al., 2018). In addition to these, it can be used for active carbon preparation (Lua and Yang, 2004) or electrically conductive flexible composites. Carbonization of agricultural wastes is a straightforward and well-known process. Since pistachio shell mostly consists of cellulose, stabilization and carbonization steps can be used as previously reported (Cetin et al., 2022).

The carbonized shells can be used for various applications such as polymer composites the conductive polymer composites can be prepared by as a function of pistachio-based carbon (PBC). The conductivity of the polymer composite can be tuned by changing the concentration of PBC. As reported in our previous studies polymer type and PBC particle size were found significant for the percolation concentration of the composites (Cetin et al., 2022)(Cetin, Toprakçı, and Toprakçı, 2022).

In addition to our previous work, in this study piezoresistive strain sensing behavior of the PBC filled flexible composites was investigated.

MATERIALS AND METHODS

Pistachio was bought from a local store. The carbonization process was performed as given in our previous studies (Cetin et al. 2022). Poly[styrene-*b*-(ethylene-co-butylene)-*b*-styrene] (SEBS) block copolymer with S/EB ratio 19/81 (Kraton) was used as the matrix. Polymer solutions were prepared by toluene (Merck) without any purification.

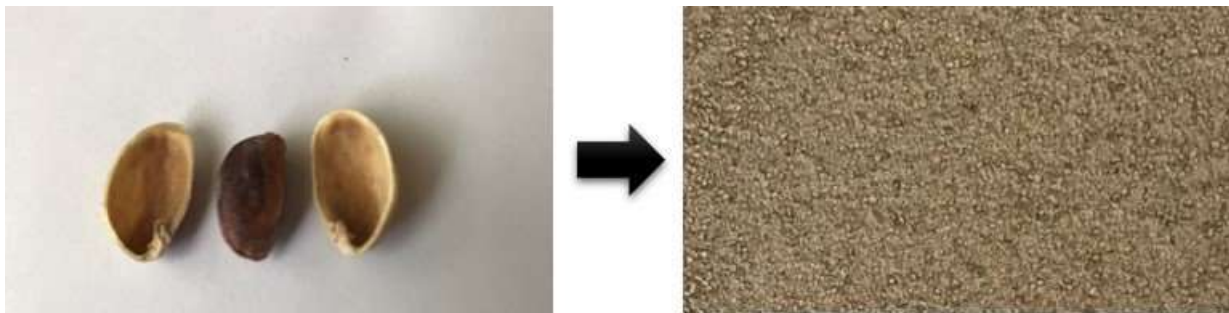

Figure 1. Pistachio shell before and after powderizing

For the electromechanical characterization, conductive composite was tested with the 30/70 PBC/SEBS composite. For the piezoresistive sensing characterization, both electrical (Keithley 2182A and Keithley 6221) and mechanical characterization systems (Devotrans DVT) were used simultaneously. For the cyclic strain sensing film with the dimensions of 25 mm × 80 mm (width, length) was cut and 4 copper probes were mounted on the sample. Following that, the sample was mounted on the system. The grip distance was 50 mm. The test speed value was 5 mm/min and strain level was 5%. Resistance was monitored as a function of time based on mechanical cycling.



Figure 2. 30/70 PBC/SEBS flexible composite

RESULTS

Cyclic piezoresistive sensing behavior of 30/70 PBC/SEBS flexible composite can be seen from Fig. 3. As obvious from the graph, sample showed piezoresistive response. However, the cyclic stability was not very smooth in the first 10 cycles. That is probably caused by level of strain. The sensitivity of the sensor was shown as R/R_0 . It basically shows the relative change in resistance as a function of applied strain. After stabilization, R/R_0 was between 1.5 and 2 that can be counted as good sensitivity under 10% strain level.

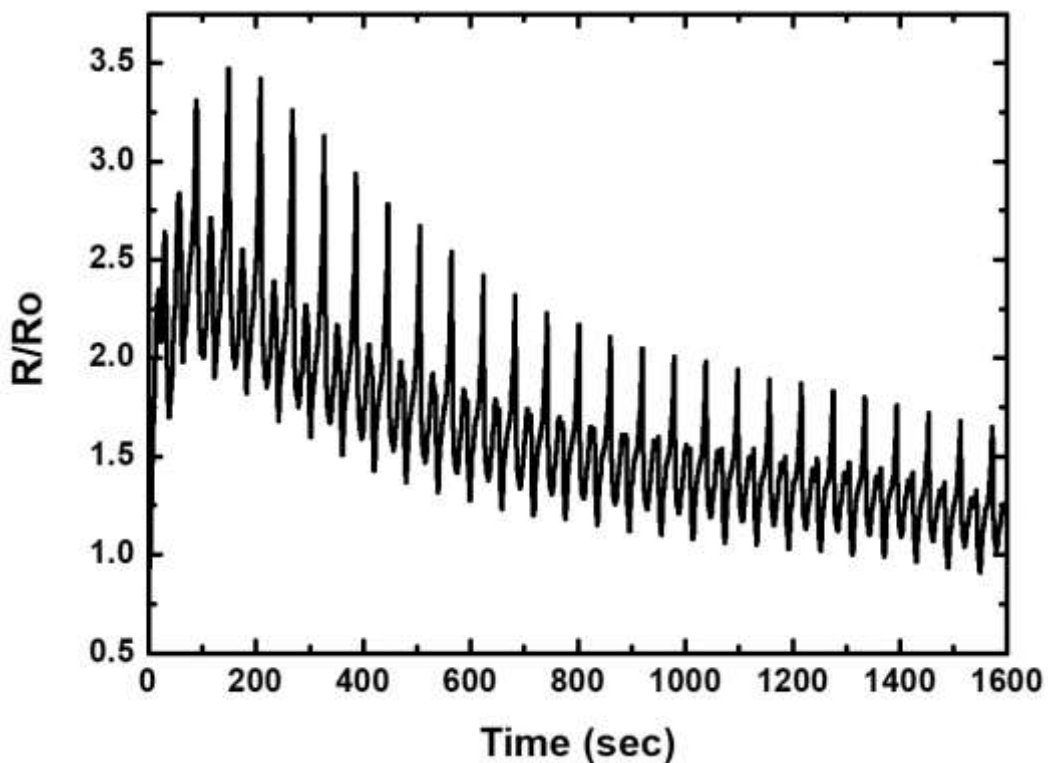

Figure 3. Cyclic stability of piezoresistive sensing for 30/70 PBC/SEBS flexible composite

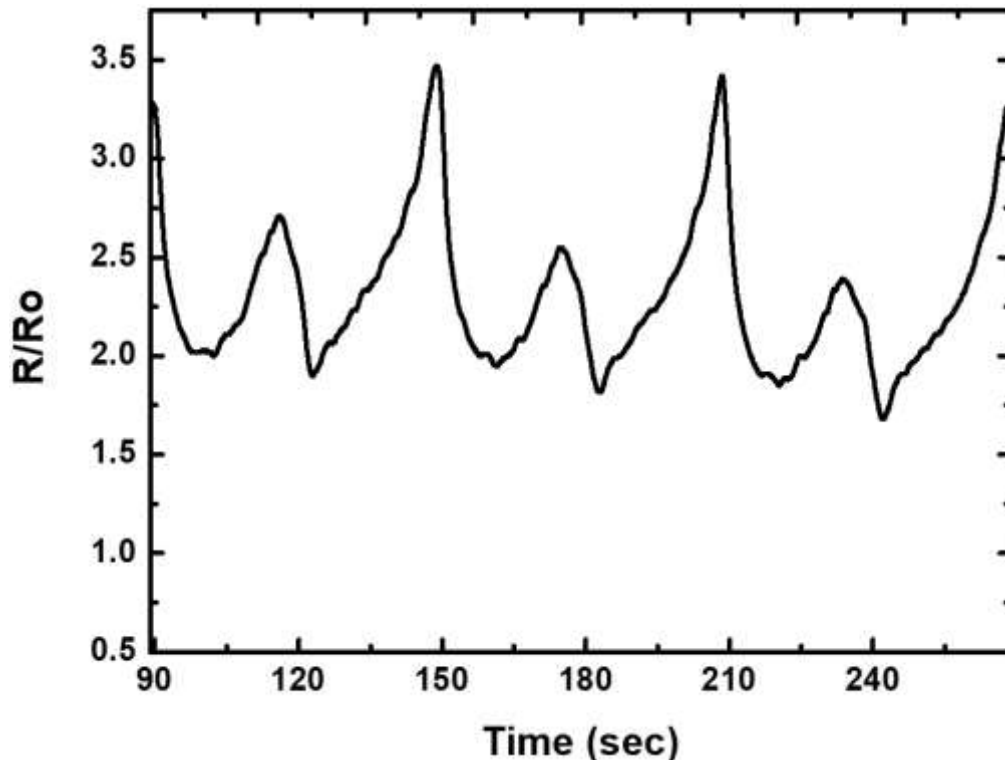

Figure 4. 3rd-5th cycles for piezoresistive sensing of 30/70 PBC/SEBS flexible composite

DISCUSSION

In order to understand the mechanism of sensing, 3rd-5th cycles were extracted from the Fig. 3, because first 2 cycles are generally show high level of hysteresis. As can be seen from the Fig. 4, the resistance drops in the loading cycle to some level then increased. Decrease in the filler-filler distance in the first place led to lower resistance. On the other hand, by further increase in strain loading, fillers started to separate from each other, and resistance started to increase. The unloading cycle almost mirror image was observed with a slight hysteresis. That was probably caused by lower strain recoverability of the composite.

CONCLUSION

In this study, piezoresistive strain sensing performance of the 30/70 PBC/SEBS flexible polymer composites was investigated. In the process, deformation ratio and test speed were kept constant. PBC filled SEBS composites were found to show piezoresistive response. The stable response was obtained after 10th cycle. These flexible sensors can be used for various applications from motion monitoring to posture analysis.

ACKNOWLEDGEMENTS

This study was supported by The Scientific and Technological Research Council of Turkey (TUBITAK), 2209-A University Students Projects Support Program 2020/2 and Yalova University Central Research Laboratory.



REFERENCES

- Alsaadi, Mohamad, Ahmet Erkliğ, and Khamis Abu-khaleefah. 2018. “Effect of Pistachio Shell Particle Content on the Mechanical Properties of Polymer Composite.” *Arabian Journal for Science and Engineering* 43(9): 4689–96.
- Celik, Yahya Hışman et al. 2020. “Characterization of Hazelnut, Pistachio, and Apricot Kernel Shell Particles and Analysis of Their Composite Properties.” *Journal of Natural Fibers*: 1–15.
- Cetin, Mukaddes Sevval et al. 2022. “Fabrication and Characterization of Conductive, Flexible Polymer Composites from Carbonized Pistachio Shell Wastes.” *Journal of the Faculty of Engineering and Architecture of Gazi University* 37(2): 711–22.
- Cetin Mukaddes Sevval, Ozan Toprakcı, and Hatice Aylin Karahan Toprakcı. 2022. “Sustainable, Alternative Conductive Fillers for Flexible Electronics: Investigation of Filler Size on Morphological and Electrical Properties of Styrene-[Ethylene-(Ethylene-Propylene)]-Styrene Block Copolymer (SEEPS) Composites.” *International Journal of Environment and Geoinformatics* 9(4): 87–94. <https://dergipark.org.tr/en/pub/ijegeo/issue/72520/1061935> (December 8, 2022).
- FAO. 2020. “FAO.” https://www.fao.org/faostat/en/#rankings/countries_by_commodity.
- Lua, Aik Chong, and Ting Yang. 2004. “Effect of Activation Temperature on the Textural and Chemical Properties of Potassium Hydroxide Activated Carbon Prepared from Pistachio-Nut Shell.” *Journal of colloid and interface science* 274(2): 594–601.
- da Silva, Jean Constantino Gomes et al. 2018. “Combustion of Pistachio Shell: Physicochemical Characterization and Evaluation of Kinetic Parameters.” *Environmental Science and Pollution Research* 25(22): 21420–29. <https://link.springer.com/article/10.1007/s11356-017-8945-1> (December 8, 2022).



HEMP-BASED PAPERS

Ozan Toprakci

Rumeysa Betül Aydogdu

Mukaddes Seval Cetin

Hatice Aylin Karahan Toprakci

Yalova University, Engineering Faculty, Department of Polymer Materials Engineering, Yalova, Turkey

Yalova University, Institute of Graduate Studies, Yalova, Turkey

Abstract

Paper is one of the most consumed products throughout human history. It is used for various applications including publishing and packaging. Paper is fabricated by using cellulose fibers that are generally obtained from the trees. In the past 10000 years, 33% of the forest-covered land in the world has been lost. The world is gradually becoming desert with the effects of overconsumption, fires, global warming, and valuable lands are being lost. Although the growing period of forests can be shortened by using recently developed special methods, these methods are highly costly. In this case, alternative, promising, environmentally friendly, sustainable raw materials compatible with circular development and economy are required. Hemp as one of the oldest plants used by human being for thousands of years, was used extensively for paper production in the past years. In this work, recent developments in hemp-based and functional hemp-based papers are given.

Keywords: Paper production, hemp paper, functional hemp papers, barrier hemp papers

KENEVİR ESASLI KAĞITLAR

Özet

Kağıt, insanlık tarihi boyunca en çok tüketilen ürünlerden birisidir. Yayıncılık ve ambalajlama dahil olmak üzere farklı uygulamalar için kullanılmaktadır. Kağıt, genellikle ağaçlardan elde edilen selüloz lifleri kullanılarak üretilmektedir. Son 10000 yılda dünyadaki ormanlarla kaplı arazinin %33'ü kaybedilmiştir. Aşırı tüketim, yangınlar ve küresel ısınmanın etkisiyle dünya giderek çölleşmekte ve değerli topraklar kaybolmaktadır. Son yıllarda geliştirilen özel yöntemler kullanılarak ormanlardaki gelişme süresi kısaltılabilir de bu yöntemler oldukça maliyetlidir. Bu durumda alternatif, gelecek vaat eden, çevre dostu, döngüsel gelişme ve ekonomi ile uyumlu sürdürülebilir hammaddelere ihtiyaç duyulmaktadır. İnsanoğlunun binlerce yıldır kullandığı en eski bitkilerden biri olan kenevir, geçmiş yıllarda kağıt yapımında yoğun bir şekilde kullanılmıştır. Bu çalışmada kenevir esaslı kağıtlar ve fonksiyonel kenevir esaslı kağıtlardaki son gelişmeler verilmiştir.

Anahtar kelimeler: Kağıt üretimi, kenevir kağıdı, fonksiyonel kenevir kağıdı, bariyer kenevir kağıdı



INTRODUCTION

Hemp is a bast fiber with many superior properties such as high mechanical strength, long fiber length, biodegradable nature. In addition to these properties, it is a sustainable raw material because of its negative zero carbon emission during growing period with high productivity. Another important point is the pesticide-free farming of hemp. Although hemp can be used for various industries such as food, medicine, composite, textile, energy storage and paper, recent environmental requirements lead to increased awareness for hemp and hemp-based products for the advantages given above.



Figure 1. Hemp fibers

Cannabis (*Cannabis sativa* L.) is a member of the Cannabinaceae family (Strzelczyk et al., 2021), has spread all over the world from central Asia. Since it is a biodegradable natural material, the history of hemp cannot be determined precisely. One of the most comprehensive studies that includes the history of hemp was reported by Barber (Barber, 1991). In his work, hemp history was reviewed based on the scientific findings from archaeological remains. As he concluded *Cannabis sativa* plant has been grown and known by the people from Asia to Anatolia and Europe esp. around the northern latitudes since Neolithic period (8000-5000 BC) (Barber, 1991). Hemp is also very common industrial plant in Turkey and according to archaeological remains, its history in north-central Turkey dates



back more than 2500 years (Barber, 1991; Tiret, 2002). From ancient times, various parts of hemp can be used including seeds, leaves and stem for various applications. Since people have noticed the high mechanical properties and the durability of hemp, they have started to use it for many products such as clothing, ropes, sails and paper (Bouloc et al., 2013).

The common point of textiles and paper is the use of hemp fibers obtained from the stem of the plant. Because hemp fibers are long, stronger and have fibrillation capacity compared to other natural cellulosic fibers. As known length and fibrillation are the most important factors for fiber interlocking. That increasing the adhesion between fibers and as a consequence of this, strength increases (Barber, 1991; Bouloc et al., 2013; Gibson, 2008).

Hemp is composed of cellulose, lignin, pectin, hemicellulose (Kostic et al., 2008). One single fiber consists by hundreds of elemental fibrils with the diameter around 5-10 nm. Elementary fibrils form nanofibrils and nanofibrils form micro-sized fibril bundles along the plant stem. Lignin and pectin bind the fiber bundles (Kostic et al., 2008; Oksman et al., 2006; Wang et al., 2007).

Since hemp can be cultivated easily with high production efficiency with possibility of harvesting more than once a year when suitable conditions are provided (Bouloc et al., 2013). In addition, when the required time for a tree to reach sufficient maturity for papermaking and the deforestation of the world by many reasons including overconsumption and fires are considered; hemp becomes as a promising, environmentally friendly, highly sustainable source for paper. Also, it is a perfect agricultural plant in terms of circular economy and sustainable engineering applications. The stem fibers are longer, stronger, and have higher fibrillation capacity compared to other cellulosic fibers (Gibson, 2008).

Since people have noticed these unique properties, they have started to use it for paper, and it has been used for more than 2000 years. Until the end of the nineteenth century, approximately most of the world's paper production was obtained from hemp. However, the prohibition and controlled cultivation of hemp in many countries have led to decrease in hemp consumption for paper production (Tiret, 2002).

In this study, different types of handmade hemp-based paper will be discussed.

MATERIALS AND METHODS

Hemp fibers were kindly provided by a local supplier in Samsun, Turkey that were grown in Narlısaray, Samsun and harvested in 2020. Plants were dried under the sun and field retting was performed for 5–6 weeks. After that the stalks were mechanically separated by crushing and breaking down and fiber bundles with woody hurds were obtained. To separate the hurds, scutching and sieving were carried out by hand. The samples were alkali treated with 1.5 wt% sodium hydroxide (NaOH) and 0.2 wt% Na_2CO_3 solutions with flote ratio of 1:10 at 180°C for 100 min. (Cetin et al., 2022). After that, samples were bleached. 1.9 wt% sodium hypochlorite (NaClO) solution was prepared by distilled water. Then fibers were impregnated into this solution with the flote ratio of 1:10 for 10 hours at room temperature. Set 1 was alkali treated hemp fibers, Set 2 was alkali treated and bleached fibers.

RESULTS

At the beginning of the chemical treatments 2 sets were prepared from 20 g of clean, washed fibers. Then both sets were alkali treated and after the treatment samples were washed until neutral pH was obtained. Both sets were dried, and treatment efficiency was determined. Set 1 and Set 2 showed almost similar cleaning efficiency as 72%. Set 2 was further processed for bleaching. After bleaching, fibers washed until neutral pH was obtained. Following that samples were dried, and weight was determined. The ratio of starting value (20 g) to bleached sample was determined around 70%. That is an indication of removal of other impurities.

The next step was handmade fabric process. The mold (200 mm × 250 mm) was prepared from mesh fabric and a wooden frame (Cetin et al., 2022). The fibers were dispersed in the water and placed on



the mold. Water was removed and surface was compacted by an iron. After compaction, papers were dried in the oven.

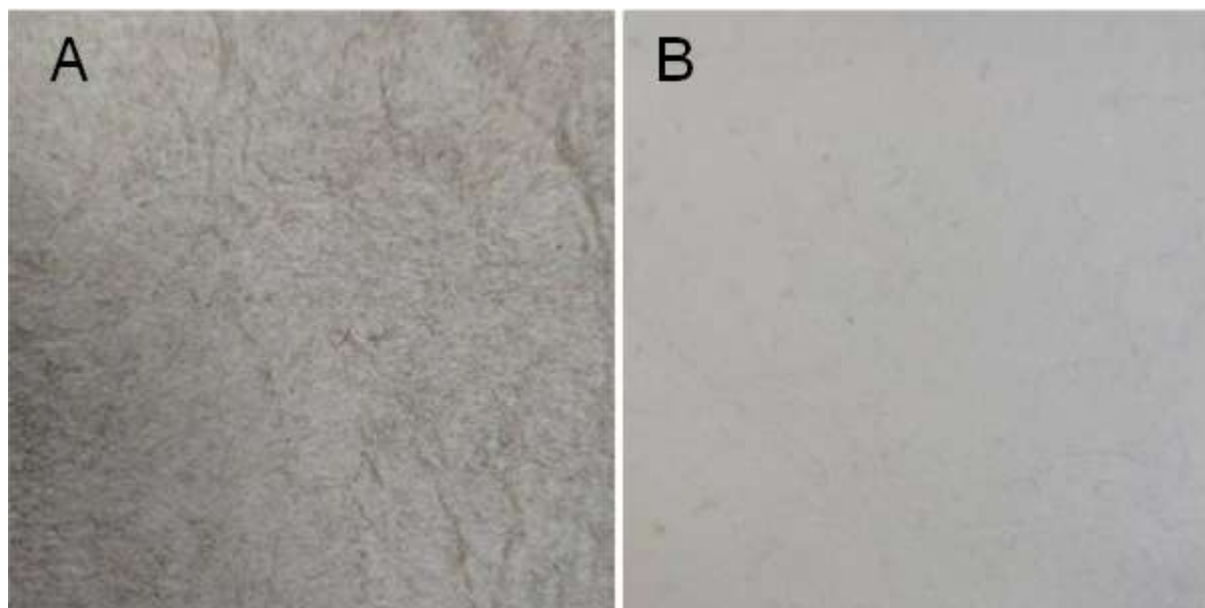

Figure 2. a) alkali treated hemp paper, b) alkali treated and bleached hemp paper

DISCUSSION

The physical properties of the papers were investigated. The color, average thickness, basis weight and texture of the papers were determined.

As shown in Fig. 2, the color of the alkali treated hemp paper was darker than bleached sample. That was caused by degradation of color pigments in the hemp.

The basis weight of alkali treated hemp paper was 329 g m^{-2} . The basis weight of bleached hemp paper was 327 g m^{-2} . Although the difference was not drastic, bleaching led to removal of extra impurities from the fiber structure and resulted in lower basis weight.

The thickness of the papers was 1.50 and 1.48 mm respectively. Similar with basis weight very slight difference was observed in terms of thickness. That can be related to the removal of extra impurities from the fiber structure.

The texture of the bleached fiber more compact and looks denser. That was probably caused by higher fibrillation degree after bleaching. That probably led to better cohesion between fibers.

CONCLUSION

Hemp is a sustainable alternative for paper fabrication. In this work two sets of paper were prepared by a handmade process. Set 1 was the alkali treated hemp paper, Set 2 was the alkali treated and bleached hemp paper. Based on the results alkali treatment was found effective for the removal of impurities and the separation of fiber bundles. On the other hand, bleaching was more effective for degradation of colorful pigments and removal of residual purities. The basic weight, thickness of the alkali treated hemp paper were found slightly higher than bleached fibers. The texture of the bleached hemp paper was more compact and denser compared to alkali treated paper.

ACKNOWLEDGEMENTS

This study was supported by The Scientific and Technological Research Council of Turkey (TUBITAK), 2209-A University Students Projects Support Program 2020/2 and Yalova University Central Research Laboratory.



REFERENCES

- Barber, E. J. W. (1991). *Prehistoric textiles: The development of cloth in the Neolithic and Bronze Ages with special reference to the Aegean* (3. print., for the Princeton paperback ed., [Repr.]). Princeton Univ. Press.
- Bouloc, P., Allegret, S., & Arnaud, L. (Eds.). (2013). *Hemp: Industrial production and uses*. CABI.
- Cetin, M. S., Aydogdu, R. B., Toprakci, O., & Karahan Toprakci, H. A. (2022). Sustainable, Tree-Free, PLA Coated, Biodegradable, Barrier Papers from Kendir (Turkish Hemp). *Journal of Natural Fibers*, 19(16), 13802–13814. <https://doi.org/10.1080/15440478.2022.2107140>
- Gibson, K. (2008). Hemp Paper: 2,000 Years On. *Journal of Industrial Hemp*, 12(2), 115–121. https://doi.org/10.1300/J237v12n02_08
- Kostic, M., Pejic, B., & Skundric, P. (2008). Quality of chemically modified hemp fibers. *Bioresource Technology*, 99(1), 94–99. <https://doi.org/10.1016/j.biortech.2006.11.050>
- Oksman, K., Mathew, A. P., Bondeson, D., & Kvien, I. (2006). Manufacturing process of cellulose whiskers/polylactic acid nanocomposites. *Composites Science and Technology*, 66(15), 2776–2784. <https://doi.org/10.1016/j.compscitech.2006.03.002>
- Strzelczyk, M., Lochynska, M., & Chudy, M. (2021). Systematics and Botanical Characteristics of Industrial Hemp *Cannabis Sativa* L. *Journal of Natural Fibers*, 19(13), 5804–5826. <https://doi.org/10.1080/15440478.2021.1889443>
- Tiret, J. S. (2002). Hemp (*Cannabis sativa* L.) Cultivation in North-Central Turkey. *Journal of Industrial Hemp*, 7(2), 73–81. https://doi.org/10.1300/J237v07n02_07
- Wang, B., Sain, M., & Oksman, K. (2007). Study of Structural Morphology of Hemp Fiber from the Micro to the Nanoscale. *Applied Composite Materials*, 14(2), 89–103. <https://doi.org/10.1007/s10443-006-9032-9>



THE EFFECT OF EXTRUSION ON THE WEAR AND CORROSION PROPERTIES OF ALMgSi_{0.5} ALLOY

Fatma MEYDANERİ TEZEL

Karabük University, Faculty of Engineering, Department of Metallurgy and Materials Science, Karabük, Türkiye.

ORCID No: 0000-0003-1546-875X

Abstract

AlMgSi alloys, known as the 6000 series, which have an important place in the ageable alloy group in the aluminum extrusion industry, are known for their good extrudability, high corrosion resistance, clean surface after hot deformation and low cost of the processes applied to obtain moderate strength. AlMgSi alloys promote their use in areas such as automotive and aerospace industry, construction sector, transportation, architectural and decorative applications with their properties such as strength, good machinability, high corrosion resistance in a comprehensive area. AA6063 alloy accounts for the vast majority of aluminum products produced by extrusion and are a suitable alloy for anodic coating. AA6063 extrusion products, in addition to having a good surface appearance, are corrosion-resistant materials and have good mechanical properties. Due to these characteristics, they are widely used in architectural applications.

In this study, the effect of extrusion on the wear and corrosion properties of AA6063 alloy was investigated. The part was cut from the billet in the Alufour Aluminum factory and taken before extrusion. Then, another part was processed at 400 °C with a ram speed of 0.3 mm/s and an extrusion ratio of 10:1. The obtained samples were subjected to potentiodynamic (Tafel) corrosion test in 3.5% NaCl solution before and after extrusion. According to these results, the most common type of pitting before extrusion is corrosion, and cavities can be easily seen from SEM images. After extrusion, these cavities are further reduced. Finally, a 200 m wear test was applied back and forth in accordance with ASTM G133 standard by applying a load of 5 N to the samples before and after extrusion. 52100 Steel balls with a hardness of 62 HRC were used in the tests. According to the wear test results, the volumetric wear loss before and after extrusion is 2.23 mm³ and 1.01 mm³, respectively; the wear rates were calculated as 0.0111 (mm³/m) and 0.0050 (mm³/m) respectively.

Keywords: AA6063 Alloys, Extrusion, Tafel Corrosion Test, Wear

INTRODUCTION

Aluminum alloys are one of the most widely used metals after steel and its alloys today. Although it is three times lighter than iron-steel, copper and brass materials, the fact that it has a high level of strength to serve its purpose is rapidly increasing the amount of use in the transportation sector of aluminum. About 1/3 of the aluminum consumed in Europe is used by the transportation sector. Aluminum is increasingly being used in automobiles, airplanes, train transportation system and passenger compartment construction, ship industry. In the automotive industry, the use of more aluminum has always been on the agenda for the development of lightweight but high-strength materials for large and low-fuel cars without sacrificing safety or comfort. Because aluminum is currently an unrivaled material for these purposes (Aluminum Reports, TMMOB).



6xxx aluminum alloys are in the class of kneaded and heat treatable alloys. They contain magnesium (0.6 - 1.2%) and silicon (0.4 - 1.4%) as the main alloying elements. Chromium and magnesium elements are added to control grain size, and copper is added to increase strength, but corrosion resistance decreases when copper is more than 0.5% by weight (Smith, 1993). The composition analysis of the AA 6063 alloy is given in Table 1.

Table 1. Chemical Composition of AA6063 Alloy.

Chemical Composition (weight %) of AA6063 Alloy.							
Cu	Fe	Mg	Mn	Si	Zn	Cr	Other Elements
0.10	0.35	0.45	0.10	0.40	0.10	0.10	

AA 6063 alloy, which is one of the most used materials in the aluminum extrusion industry, is one group of the aluminum alloys that can be hardened by heat treatment. This alloy, which has a high formability and whose mechanical values can be significantly increased by heat treatment, is generally Al-Mg-Si alloy (Sönmez, 1989). The sectors where AA 6063 alloy profiles produced by extrusion method are most commonly used are construction / architecture (frontage cladding, windows, doors, decoration, furniture), automotive, electrical / electronic and machine manufacturing sectors (Karamış ve Halıcı, 2007; Saha, 2000; Sönmez, 1989). It is known that the mechanical properties of AA 6063 depend on the amount of Mg₂Si. Mechanical properties improve with increasing amount of Mg₂Si, whereas extrusion capability decreases. AA 6063 alloy accounts for the vast majority of aluminum products produced by extrusion and are a suitable alloy for anodic coating. In addition to having a good surface appearance, AA 6063 extrusion products are corrosion-resistant materials and have good mechanical properties. Due to these characteristics, they are widely used in architectural applications. If the amount of silicon in the alloy is more than the amount that will form the stoichiometric compound, the strength increases. In turn, the strength decreases when there is an increase in this ratio in favor of magnesium. In addition, the extrusability is also negatively affected by the increase in magnesium (Baumgarten et al. 1984; Zoller et al. 1965). However, it should be taken into account that if the amount of silicon in the alloy is increased in order to obtain high strength values, defects called “black points” may occur on the surface as a result of precipitation of silicon. When precipitating elements such as manganese, chromium, and zirconium are present in Al-Mg-Si alloys, precipitating phases will form at high temperature (~500 °C) during the homogenization process (Lang, 1978; Otori, 1984). A significant amount of excess silicon precipitates as elemental silicon and primary silicon at the grain boundaries, causing inter-grain fracture. In addition, silicon causes an increase in strength and decrease in ductility by thinning the morphology of Mg₂Si. Copper also affects the morphology of Mg₂Si precipitate, increasing the strength but reducing the ductility (Scharf, 1984). Other alloys that do not have a precipitation hardening mechanism can be hardened by deformation hardening. The aim of this study is to investigate the effect of extrusion on the wear and corrosion properties of AA6063 alloy.

MATERIALS AND METHODS

In this study, AA6063 alloy was cut from the billet in the Alufour Aluminum factory and taken before extrusion. Then, another part was processed at 400 °C with a ram speed of 0.3 mm/s and an extrusion ratio of 10:1. The samples were cut with the cutting device. The obtained samples (before and after extrusion) were subjected to Chronopotentiometry (Tafel) corrosion test in 3.5% NaCl solution, and then corrosion SEM images were analyzed. Finally, a 200 m wear test was applied back and forth in accordance with ASTM G133 standard by applying a load of 5 N to the samples before and after extrusion. 52100 Steel balls with a hardness of 62 HRC were used in the tests. According to the wear test results, the volumetric wear loss and the wear rates were calculated for samples before and after extrusion.



RESULTS AND DISCUSSION

In this study, potentiodynamic (Tafel) corrosion test was applied to the obtained before and after extrusion samples in 3.5% NaCl solution. According to the corrosion test results, the most common type of corrosion for aluminum is pitting corrosion and as can be seen in Figure 1, cavities can also be easily seen from the FESEM results. It is seen that the solidification conditions, the applied heat treatment and deformation are very effective on the structure and distribution of intermetallics. The Tafel-potentiodynamic corrosion test results of the AA6063 alloy are given in Table 2.

Table 2. Tafel- Potentiodynamic Test Results and Corrosion Properties of AA6063 Alloy.

Corrosion Test	Potentiodynamic
Open Circuit Potential (O.C.P.) Measuring Time	900 s
Scan Rate	2 mV / s
Scanning Interval	-0.5 V vs. O.C.P. to 0.5 V vs. O.C.P.
Reference Electrode	Ag / AgCl (3.5 mol KCl)
Counter Electrode	A pair of graphite rods
Electrolyte (Corrosive Environment)	3.5 % NaCl solution
Tafel Extrapolation	Cathodic Only
G 102 – 89 (2004)	Standard Practice for Calculation of Corrosion Rates and Related Information from Electrochemical Measurements

Specimen	Surface (cm ²)	CC (μA)	CCD (μA / cm ²)	CR (mm / year)	E _{corr} (V)	Density ³ (g/ cm)	E.W. (g)
Before Extrusion	0.283	1.57	5.55	0.061	-0.613	2.70	9.05
After Extrusion	0.431	2.28	5.29	0.058	-0.584	2.70	9.05

CC : Corrosion Current, CCD: Corrosion Current Density, CR: Corrosion Rate, E_{corr}:Corrosion Potential,

E.W: Equivalent Weight of an electron for the corresponding electrochemical process.

When precipitating elements such as manganese, chromium and zirconium are present in Al-Mg-Si alloys, precipitating phases will form at high temperature (~500 °C) during the homogenization process (Lang, 1978; Ohori, 1984). These precipitates form a fine bottom grain structure during the extrusion process, preventing recrystallization and protecting the fibrous structure during extrusion. In AA 6063 series aluminum alloys, magnesium and silicon combine stoichiometrically in a ratio of 1.73:1 and form Mg₂Si precipitate, which is a stable α phase in the equilibrium diagram. The Mg₂Si phase is typically more active than Al and preferentially corrodes, leading to regional corrosion (pitting formation etc.), occurs causing inter-grain corrosion and stress corrosion cracking. Accordingly, as can be seen from Figure 2, these cavities decrease even more after extrusion.

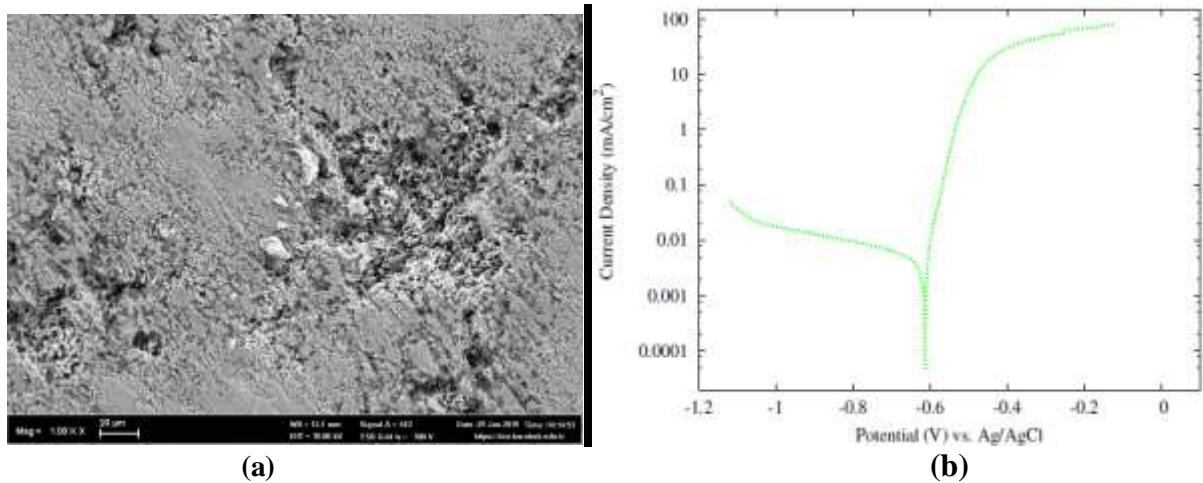

Figure 1. (a) Corrosion FESEM images and (b) Tafel curve before extrusion of Al6063 Alloy.

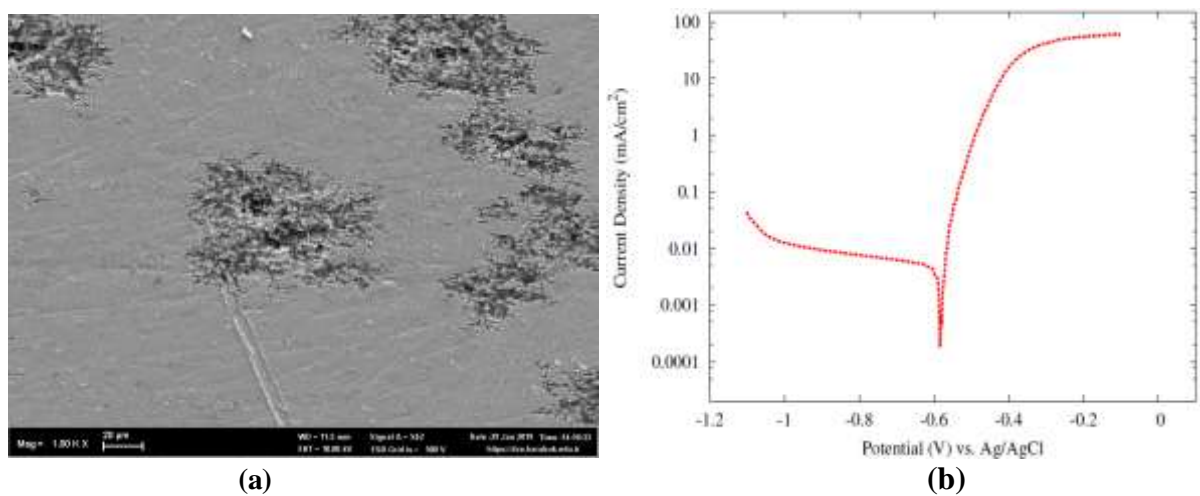

Figure 2. (a) Corrosion FESEM images and (b) Tafel curve after extrusion of Al6063 Alloy.

In the test, forward-back 200 m wear test was applied in accordance with ASTM G133 standard by applying a load of 5 N to the samples before and after extrusion. Wear prints show that oxidation has occurred in the specimen surface. As a result of friction, the edges are oxidized. White visible regions are oxidized layers. Detritus/delaminations have occurred due to wear in the region close to some edge. Small particles breakage occurred, because the sample is a soft material. As a result, this is an abrasive wear. According to the wear test results, the volumetric wear loss before and after extrusion is 2.23 mm³ and 1.01 mm³, respectively; the wear rates were calculated as 0.0111 (mm³/m) and 0.0050 (mm³/m) respectively. Figures 3 and 4 show the wear marks of the samples before and after extrusion, respectively. Table 3 shows the wear test data obtained for the samples before and after extrusion.

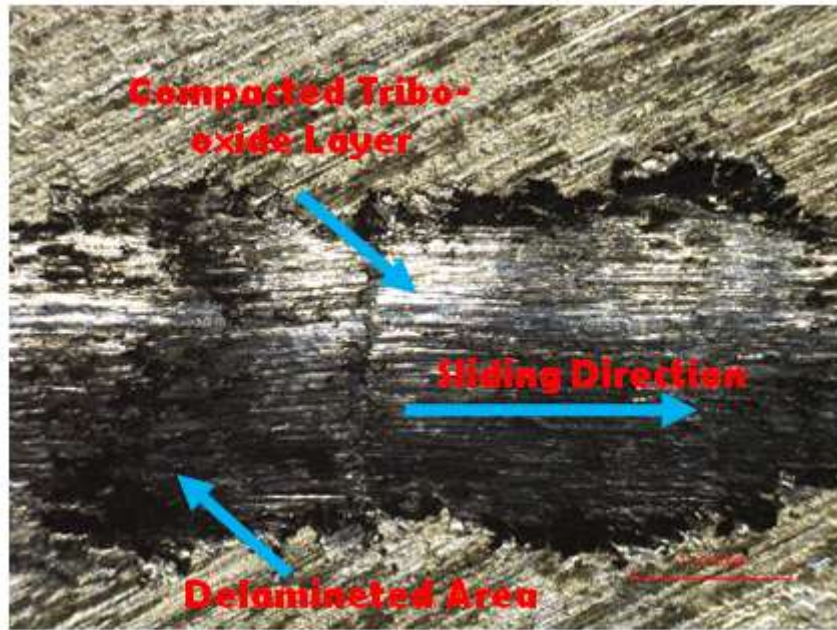

Figure 3. Wear print of before extrusion of Al6063 Alloy.

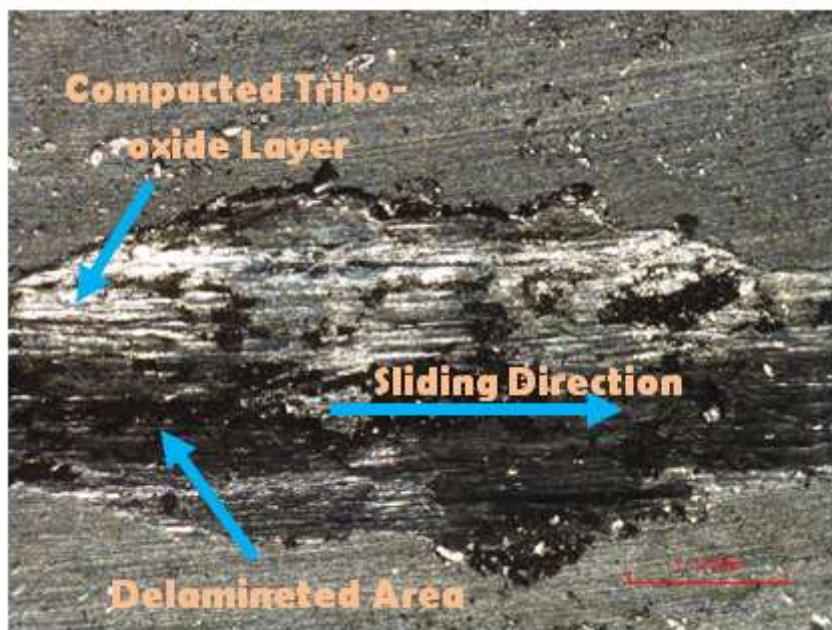

Figure 4. Wear print of after extrusion of Al6063 Alloy.

**Table 3.** Wear Test Results of Al6063 Alloy

Before Extrusion	Applied Load (N)	5
	Wear Width (mm)	1.84
	Wear Length (mm)	5.20
	Wear Depth(mm)	0.35
	Wear Volume Loss (mm ³)	2.232
	Wear Rate (mm ³ /m)	0.0111
After Extrusion	Applied Load (N)	5
	Wear Width (mm)	1.46
	Wear Length (mm)	5.19
	Wear Depth(mm)	0.20
	Wear Volume Loss (mm ³)	1.01
	Wear Rate (mm ³ /m)	0.0050

CONCLUSION

As a result, according to the corrosion test results, precipitation at the grain boundaries of the extruded sample and the Mg₂Si intermetallic phase in the structure prevented recrystallization by forming a fine subgrain structure during the extrusion process, and pitting corrosion did not progress, ensuring the protection of the fibrous structure during extrusion. In addition, the aluminum-oxide thin film layer formed by aluminum on the surface also prevents the progression of corrosion. According to the wear test results and prints, abrasive wear was observed. Due to the high dislocation density of the extruded sample, the wear loss and wear rate are lower.

REFERENCES

- Alüminyum Raporu, TMMOB Metalurji Mühendisleri Odası, Alüminyum Komisyonu, 24. Dönem Çalışma Raporu.
- Baumgarten J. (1984) Investigation of Some steps in the Production of Al-Mg₂-Si Extrusion with High Quality, ET'84 Extrusion Productivity Through Automation, The Aluminium Association USA, Vol:2, 4-48.
- Karamış, M. B., & Halıcı, İ. (2007). The effects of homogenization and recrystallization heat treatments on low-grade cold deformation properties of AA 6063 aluminum alloy. *Materials Letters*, 61(4-5), 944-948.
- Lang G., Castle A.F. (1978). Influence of Copper, manganese and Chromium Additions on the Extrudability of AlMgSi0.5 Alloys, *Light Metal Age* 2, 26-28.
- Ohori K., Takeuchi Y., Matsuyama H. (1984). Combination Effect of Mn and Zr Additions on the Properties of AlMgSi Alloys, *Proceedings 3rd International Aluminium Extrusion Technology Seminar*, Vol:1, Atlanta.
- Saha, P. K. (2000). *Aluminum extrusion technology*. Asm International.
- Scharf G., Grzempa B. (1984). Notch Sensitivity in Wrought AlMgSi Alloys, *Proceedings 3rd*



INTERNATIONAL ASIAN CONGRESS ON CONTEMPORARY SCIENCES – VII

International Aluminium Extrusion Technology Seminar, Vol:1, Atlanta.

Smith, W.F. (1993). Structure and properties of engineering alloys, McGraw-Hill-New York, 557.

Sönmez, H. (1989). Metal Ekstrüzyonu, Eğitim Yayınları A.Ş., İstanbul.

Zoller V. H., Ried A. (1965). Metallkundliche Grundlagen der Leicht Pressbaren AlMgSi-Ligerungen, Aluminium 51.



MICROSTRUCTURE AND MECHANICAL PROPERTIES OF ALLOY 7075-T7351

Fatma MEYDANERİ TEZEL

Karabük University, Faculty of Engineering, Department of Metallurgy and Materials Science,
Karabük, Türkiye.

ORCID No: 0000-0003-1546-875X

Abstract

In the aircraft and automotive industry, it is necessary to use light metals with high strength. 7xxx series aluminum alloys contain 4-8% Zn and 1-3% Mg and are ideal materials for the aircraft, aerospace and automotive sectors, as they have higher hardness and strength than other aluminium alloys. Since zinc and magnesium from these elements are highly soluble in aluminium, it is ensured to increase the precipitation strength. 7xxx series aluminium alloys increase their strength as a result of precipitation formed after quenching and aging after solid solution. 7xxx series aluminium alloys are increased in strength as a result of precipitation formed after quenching and aging after solid solution.

In this study, to investigate the microstructure and mechanical properties of AA7075 alloy due to aging mechanisms with T7351. The thick section AA7075 aluminium alloy was first heated to 480 °C with a temperature increase of 50 °C per hour and kept at this temperature for 4 hours. Then the alloy was cooled by water and aged at 180 °C for 75 minutes. The structural properties of the sample were obtained by XRD, surface morphologies were obtained by FESEM and composition analysis was obtained by EDX. The maximum compressive strength, yield strength, toughness and resistance values were obtained as 1192.46 MPa, 530.73 MPa, 169.58 J and 60.47 J, respectively. The Vickers hardness value was obtained as 178 Hv_{0.5}. According to these results, since precipitation hardening occurs at grain boundaries and shear planes, the deformation decreased and the intermetallic phases formed also provided an increase in strength. According to these results, since precipitation hardening occurred at grain boundaries and shear planes, the deformation decreased and the resulting intermetallic phases increased the strength.

Keywords: AA7075 Alloys, Mechanical Properties, Hardness

INTRODUCTION

About 21% of the world's energy demand is spent on the production of raw materials. During this production, approximately 25% of global carbon dioxide emissions occur (Ingarao et al., 2018; Latif et al., 2022). After steel, the most commonly used and produced metal is aluminum (Brough & Jouhara, 2020). Due to its low density, its energy efficiency is high and it is used quite a lot in automobile body structures (Alidokht et al., 2012; Lin & Chen, 2011). Therefore, these alloys, which can be hardened by precipitation as a result of heat treatment, such as Al-Zn-Mg(-Cu), has been promising for the automotive and aerospace industry with the characteristics of durability-weight ratio, corrosion resistance and excellent fracture toughness (Tisza & Czinege, 2018; Harrison & Lukey, 2014). AA7075 alloy is also one of the AlZnMgCu or 7xxx series aluminum alloys group because it has high strength, hardness and corrosion resistance (Kazemi-Navaee et al., 2021; Canakci & Varol, 2014).



In order to improve the strength and hardness of aluminum alloys, precipitation hardening heat treatment is usually applied. The appearance, light weight, machinability, excellent corrosion resistance and mechanical properties of aluminum and its alloys have made it both economical and highly applicable. The maximum tensile strength of these metals, which allows the production of automotive body parts, is up to the order of 600 MPa. Although it is not considered very suitable for high temperatures above 300 °C, it is another property that they retain their mechanical properties at low temperatures. In addition, they have high corrosion resistance in different environments (for example, air, water, salt water and petrochemicals) (Craig and Anderson, 1995).

It is necessary to apply heat treatment when forming or before forming for 7XXX series aluminum alloys which are Al-Zn-Cu-Mg alloy (Vallellano et al., 2008; Hui et al., 2012). AA7075 alloy is usually subjected to aging heat treatment. If the 7XXX series alloys are aged at low temperatures, it is observed that dense Guinier-Preston (GP) regions are formed within the structure. In the literature, it is observed that there is a limited number of annealing and aging heat treatments for AA7075 alloy.

Panigrahi and Jayagantha applied annealing process between 150 °C and 400 °C temperatures for 1 hour after the cryogenic cooling process (CR) applied to the 7075 alloy at temperatures of -150 °C and -75 °C. It was observed that the recrystallization process started at 150 °C annealing temperature and completed at 250 °C for 7075 alloy which the CR process has been applied. The hardness and tensile strength values of this alloy was suddenly reduced between 150 °C and 250 °C annealing temperatures, but they observed that there was no sudden change in the later temperature values (Panigrahi & Jayaganthan, 2011).

Polak and colleagues analyzed the warm forming process of a bracket made of T6 temper 7075 aluminum alloy. The microhardness of the produced bracket was tested and the stress-elongation curves of the selected bracket areas were determined. It was concluded that since the 7075 aluminum alloy has a precipitation hardening, it is impossible to achieve high strength after forming without additional processes. According to the result, the final tensile strength has increased to 520 MPa. The ultimate tensile strength of T6 temper 7075 alloy is equal to 580 MPa. The presented forming technology results in a strength reduction of 11% (Polak et al., 2017).

Huo and his colleagues have conducted research on the formability, microstructure and properties for peak-aged AA7075 alloy starting from room temperature up to 250 °C. The optimum temperature for formability was found to be 200 °C, and high ductility and hardening ability were observed at this temperature. Accordingly, the dominant phases in the warm formed AA7075-T6 alloy at 200 °C and 250 °C were obtained η' and GP regions as well-developed η' and coarser η phases, respectively (Huo et al., 2016).

In other studies, the formability ability of the AA7075 alloy system at higher temperatures up to 400 °C was studied (Rajamuthamilselvan & Ramanathan, 2011; Gupta et al., 2019; Li et al., 2019; Sajadifar et al., 2020). In experimental studies carried out depending on the thermal softening behavior, it was observed that the formability increased, but the strength decreased even more when compared with room temperature. In the literature, it has been determined that the studies related to the heat treatment of AA7075 alloy have not been sufficiently investigated depending on the parameters. In this study, it was aimed to investigate the changes in the microstructure and mechanical properties of T7351 heat treatment applied to AA7075 alloy.



MATERIALS AND METHODS

In this study, AA7075 aluminum alloy with the thick-section, which was supplied ready-made from the industry, was first heated to 480 °C with a temperature increase of 50 °C per hour and kept at this temperature for 4 hours. Then, the alloy was cooled by water and aged at 180 °C for 75 minutes. For 6 prepared samples were applied to the cutting (Struers I discoto-100 brand), mounting (Struers CitoPress - 10 brand Hot moulding), grinding (Struers from a variety-30 Device brand 400, 600, 800, 1000, 1200, 2400 using SiC paper) and polishing (water-based solution diamond 6 μm, 3 μm, 1 μm) after etching (3% nital solution) process, respectively. Then, the surface micrographs were imaged with FESEM (Carl Zeiss Ultra Plus Gemini FESEM /KBU-MARGEM) and optical microscope (Nikon Inverted Metallurgical Microscope/KBU-MARGEM). The structural properties were obtained by XRD (Rigaku Ultima IV model) diffractogram analysis. The hardness measurement of the samples is obtained with the Vickers hardness device (Qness Q10 A+ model), and the compression test (with Zwick/Roell Z600 Universal model device according to TS 206 standard) was applied at room temperature.

RESULTS AND DISCUSSION

FESEM and optical microscope images of T7351 heat-treated samples applied to AA7075 alloy are given in Figure 1, and composition analysis is given in Table 1. Microstructure studies indicate the presence of some intermetallics in the base metal. These intermetallics have been described in the literature as Al_7Cu_2Fe , $(Al, Fe)_6(Fe, Fe)$ and Mg_2Si . The characteristic microstructural components formed after the heat treatment of T7351 consist of GP regions and primary α -Al phase, semi-stable η' ($MgZn_2$) and $\theta(Al_2Cu)$ precipitates. In these phases, the XRD confirms the results and the XRD diffraction pattern is given in Figure 2.

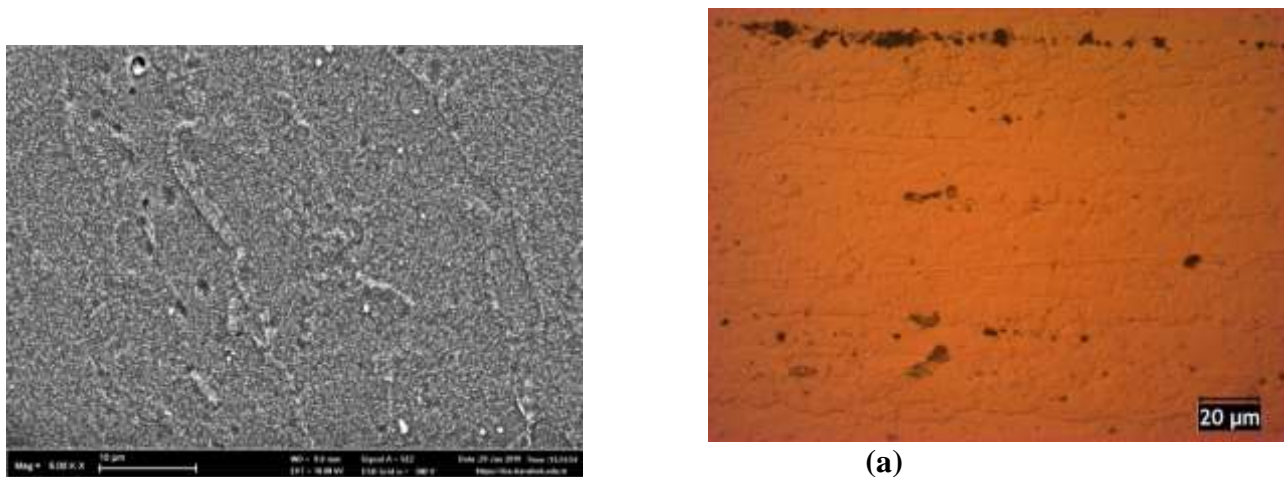

Fig. 1. AA7075-T7351 alloy (a) FESEM image; (b) optical microscope image.

Table 1. Composition analysis of AA7075-T7351 alloy.

Fe	Si	Cu	Mn	Mg	Zn	Cr	Zi+Ti	Diğer	Al
0.5	0.5	1.2-2.0	0.3	2.1-2.9	5.1-6.1	0.18-0.28	0.25	0.15	Rest.

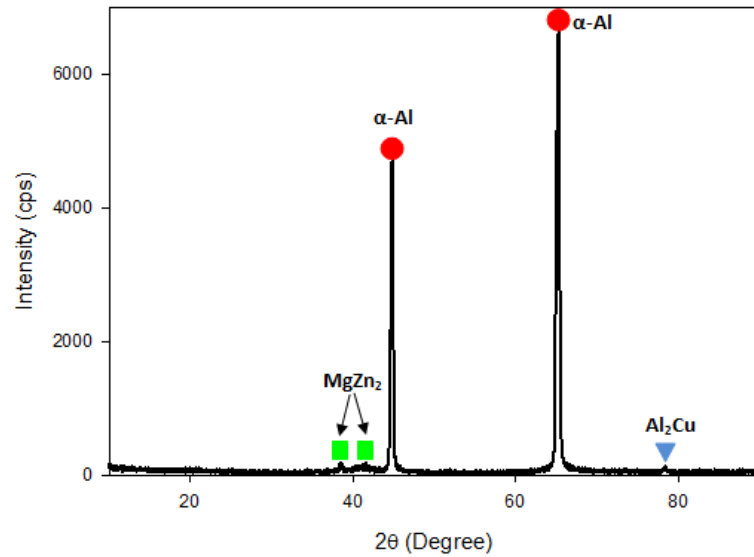

Fig. 2. XRD diffractogram of AA7075-T7351 alloy.

For the T7351 heat treated sample applied to AA7075 alloy, average Vickers microhardness value was determined by applying 0.5 kilogram load for 15 seconds from 5 different points. Accordingly, the Vickers microhardness value was found to be 178 HV0.5.

The compression test graph for the T7351 heat-treated sample applied to the AA7075 alloy is given in Figure 3. The maximum compressive strength, yield strength, toughness and resilience values for the T7351 heat-treated sample applied to the AA7075 alloy were obtained as 1192.46 MPa, 530.73 MPa, 169.58 J and 60.47 J, respectively.

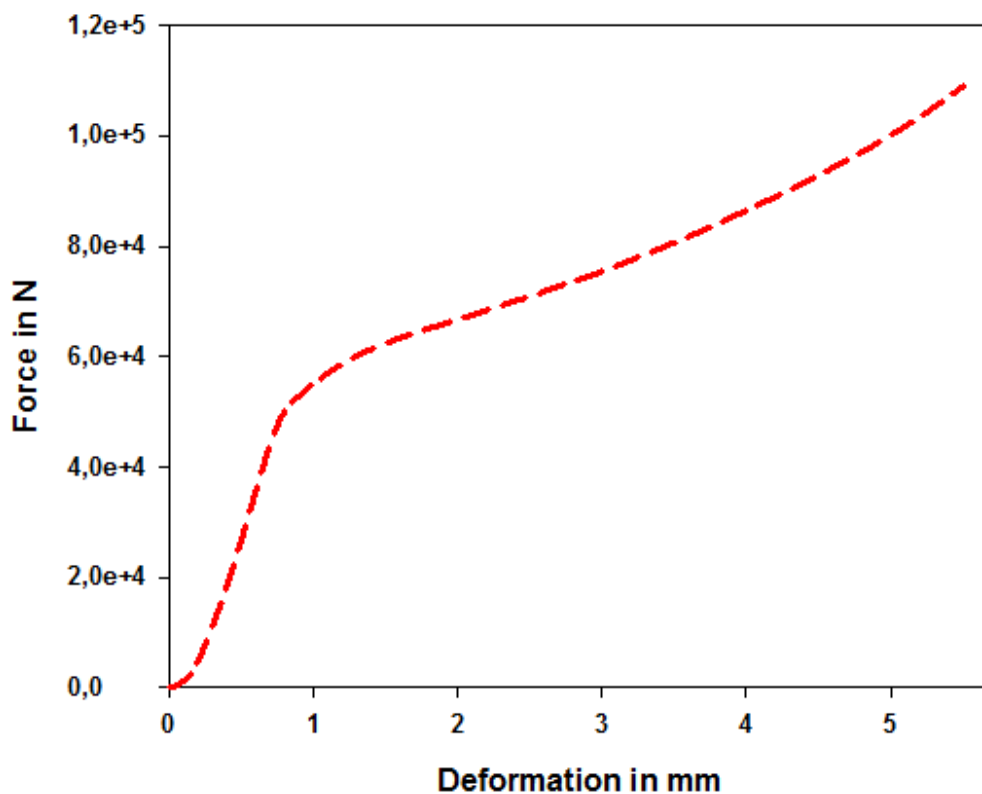

Fig. 3. Compression test graph of AA7075-T7351 alloy.



Zn, Mg and Cu atoms at high concentrations easily induce phase separation, and this phenomenon is related to environmentally sensitive embedding energy. Therefore, for a large value of the environmentally sensitive embedding energy, more solute atoms are affected by the surrounding environment, so that they become unstable and spread to the stable environment, where the environmentally sensitive embedding energy is low. In precipitation hardening, it also shows that the environmentally sensitive embedding energy of Zn atoms in the α -Al grain matrix is lower than that at the α -Al grain boundary, so the Zn atoms are tightly embedded in the α -Al grain matrix. Moreover, environmentally sensitive Mg and Cu atoms have higher embedding energies than Zn atoms. Therefore, it is noted that Mg and Cu atoms have lower solid solubility in the α -Al grain matrix (Yang et al., 2019), and the XRD result also support them. For this reason, the semi-stable η' (MgZn_2) and $\theta(\text{Al}_2\text{Cu})$ phases formed in the grain and at the grain boundaries provided an increase in hardness and strength.

CONCLUSION

According to these results, as a result of the T7351 heat treatment applied to the AA7075 alloy, semi-stable intermetallic phases were formed in the grain and grain boundary depending on the concentration of Mg, Zn and Cu in the α -Al matrix phase at the structural examinations. Since precipitation hardening occurs at grain boundaries and shear planes, forming has decreased, and the intermetallic phases formed have also provided both strength and hardness increases.

REFERENCES

- Alidokht, S. A., Abdollah-Zadeh, A., Soleymani, S., Saeid, T., & Assadi, H. (2012). Evaluation of microstructure and wear behavior of friction stir processed cast aluminum alloy. *Materials Characterization*, 63, 90-97.
- Brough, D., & Jouhara, H. (2020). The aluminium industry: A review on state-of-the-art technologies, environmental impacts and possibilities for waste heat recovery. *International Journal of Thermofluids*, 1, 100007.
- Canakci, A., & Varol, T. (2014). Microstructure and properties of AA7075/Al-SiC composites fabricated using powder metallurgy and hot pressing. *Powder Technology*, 268, 72-79.
- Craig D.B., Anderson D.S (ed. by), Handbook of Corrosion Data, A.S.M International, page 16-18,1995.
- Gupta, R. K., Anil Kumar, V., Sarath Krishnan, A., & Niteshraj, J. (2019). Hot deformation behavior of aluminum alloys AA7010 and AA7075. *Journal of Materials Engineering and Performance*, 28(8), 5021-5036.
- Harrison, N. R., & Luckey, S. G. (2014). Hot stamping of a B-pillar outer from high strength aluminum sheet AA7075. *SAE International Journal of Materials and Manufacturing*, 7(3), 567-573.
- Hui, W. A. N. G., Luo, Y. B., Friedman, P., Chen, M. H., & Lin, G. A. O. (2012). Warm forming behavior of high strength aluminum alloy AA7075. *Transactions of Nonferrous Metals Society of China*, 22(1), 1-7.



Huo, W., Hou, L., Zhang, Y., & Zhang, J. (2016). Warm formability and post-forming microstructure/property of high-strength AA 7075-T6 Al alloy. *Materials Science and Engineering: A*, 675, 44-54.

Ingarao, G., Priarone, P. C., Deng, Y., & Paraskevas, D. (2018). Environmental modelling of aluminium based components manufacturing routes: additive manufacturing versus machining versus forming. *Journal of Cleaner Production*, 176, 261-275.

Kazemi-Navaee, A., Jamaati, R., & Aval, H. J. (2021). Asymmetric cold rolling of AA7075 alloy: the evolution of microstructure, crystallographic texture, and mechanical properties. *Materials Science and Engineering: A*, 824, 141801..

Latif, A., Ingarao, G., & Fratini, L. (2022). Multi-material based functionally graded billets manufacturing through friction stir consolidation of aluminium alloys chips. *CIRP Annals*.

Li, H., Hu, Z., Hua, L., & Sun, Q. (2019). Influence of thermal deformation parameters on mechanical properties and microstructure evolution of AA7075 aluminum alloy during hot stamping-quenching process. *JOM*, 71(12), 4778-4788.

Lin, Y. C., & Chen, X. M. (2011). A critical review of experimental results and constitutive descriptions for metals and alloys in hot working. *Materials & Design*, 32(4), 1733-1759.

Panigrahi, S. K., & Jayaganthan, R. (2011). Effect of annealing on thermal stability, precipitate evolution, and mechanical properties of cryorolled Al 7075 alloy. *Metallurgical and Materials Transactions A*, 42(10), 3208-3217.

Polak, S., Kaczyński, P., Gronostajski, Z., Jaskiewicz, K., Krawczyk, J., Skwarski, M., ... & Chorzępa, W. (2017). Warm forming of 7075 aluminum alloys. *Procedia engineering*, 207, 2399-2404.

Rajamuthamilselvan, M., & Ramanathan, S. (2011). Hot deformation behaviour of 7075 alloy. *Journal of Alloys and Compounds*, 509(3), 948-952.

Sajadifar, S. V., Scharifi, E., Weidig, U., Steinhoff, K., & Niendorf, T. (2020). Performance of thermo-mechanically processed AA7075 alloy at elevated temperatures—From microstructure to mechanical properties. *Metals*, 10(7), 884.

Tisza, M., & Czinege, I. (2018). Comparative study of the application of steels and aluminium in lightweight production of automotive parts. *International Journal of Lightweight Materials and Manufacture*, 1(4), 229-238.

Yang, X., Li, Y. D., Luo, X. M., Zhou, H. W., Cai, Q. Y., Li, M., & Ma, Y. (2019). Microstructural evaluation and mechanical properties of 7075 aluminum alloy prepared by controlled diffusion solidification. *China Foundry*, 16(4), 238-247.

Vallellano, C., Morales, D., & García-Lomas, F. J. (2008). A study to predict failure in biaxially stretched sheets of aluminum alloy 2024-T3. *Materials and Manufacturing Processes*, 23(3), 303-310.



BİLYALI DÖVÜLMÜŞ BIYOMEDİKAL TİTANYUM ALAŞIMLARININ YÜZEY VE YÜZEY ALTI MEKANİK ÖZELLİKLERİNİN İNCELENMESİ

Emirhan Çalım

Fikret Sönmez

Yasemin Yıldırım Avcu

Eleftherios Iakovakis

Eray Abakay4, Funda Gül Koç

Rıdvan Yamanoglu

Egemen Avcu

Makine Mühendisliği Bölümü, Kocaeli Üniversitesi, Kocaeli, 41001, Türkiye

Makine Mühendisliği Bölümü, Hasan Ferdi Turgutlu Teknoloji Fakültesi, Manisa Celal Bayar Üniversitesi, Manisa 45140, Türkiye

Makine Havacılık ve İnşaat Mühendisliği Bölümü, Manchester University, Manchester; M13 9PL, UK

Metalürji ve Malzeme Mühendisliği, Sakarya Üniversitesi, Sakarya 54050, Turkey

Metalürji ve Malzeme Mühendisliği, Kocaeli Üniversitesi, Kocaeli 41001, Türkiye

Ford Otosan Meslek Yüksek Okulu, Kocaeli Üniversitesi, Kocaeli, 41650, Türkiye

Özet

Titanyum alaşımları gelişmiş mekanik özellikleri, yüksek spesifik mukavemetleri ve biyouyumlulukları nedeniyle biyomedikal uygulamalarda sıklıkla kullanılmaktadır. Ancak bu uygulamalarda güven içinde kullanılabilmesi için yüzey ve yüzey altı mekanik özelliklerinin incelenmesi oldukça önemlidir. Bu çalışmada bilyalı dövülmüş biyomedikal titanyum alaşımların mekanik özelliklerinin incelenmesinde kullanılacak sertlik haritalama yönteminin uygulanabilirliği incelenmiştir. Çalışmada ilk aşamada, bilyalı dövülmüş malzemelerin mekanik özelliklerinin incelenmesi üzerine güncel çalışmalar derlenmiştir. İkinci aşamada ise toz metalürjisi yöntemi ile ticari saflıkta titanyum alaşımı (Cp-Ti) üretilmiş, üretilen alaşım bilyalı dövülmüş ve bilyalı dövme sonrası değişen yüzey altı mekanik özellikleri mikrosertlik haritalama yöntemi ile incelenmiştir. Cp-Ti titanyum alaşım tozları sıcak pres cihazı kullanılarak 45 MPa basınç altında, 30 dakika 950 °C’de sinterlenmiştir. Sonrasında özel tasarım bilyalı dövme sistemi ile 7 bar basınçta 600 µm -1000 µm arası boyutta paslanmaz çelik bilyalar kullanılarak numuneler dövülmüştür. Dövülen numunelerin sertlik taraması 0,2 kg yük altında gerçekleştirilmiş, elde edilen sertlik değerleri Matlab® üzerinde geliştirilen bir algoritma yardımıyla işlenerek sertlik dağılım haritaları elde edilmiştir. Uygulanan mikrosertlik haritalama yöntemi bilyalı dövülen Cp-Ti alaşımında, yüzeydeki sertlik artışını ve bu sertlik artışının merkeze doğru kademeli olarak azalmasını net bir şekilde görselleştirmiştir. Bu çalışmanın çıktılarının, farklı alaşım grupları için bilyalı dövme sonrası yüzey altı mekanik özelliklerin derinlemesine incelenmesinde faydalı olacağı sonucuna varılmıştır.

Anahtar Kelimeler: Biyomedikal Titanyum Alaşımları, Bilyalı Dövme, İndentasyon, Mikrosertlik Haritalama, Toz Metalürji



INVESTIGATION OF SURFACE AND SUBSURFACE MECHANICAL PROPERTIES OF SHOT PEENED BIOMEDICAL TITANIUM ALLOYS

Abstract

Titanium alloys have been widely used in biomedical applications due to their advanced mechanical properties, high specific strength, and biocompatibility. It is essential to examine the surface and subsurface mechanical properties of titanium alloys for their safe use in these applications. In this study, the applicability of the hardness mapping method, which can be used to examine the mechanical properties of shot-peened biomedical titanium alloys, was investigated. In the first stage of the study, recent studies on the examination of the mechanical properties of shot-peened materials were summarized. In the second stage, commercial-grade titanium alloy (Cp-Ti) was produced by the powder metallurgy method, the produced alloy was shot-peened, and the microhardness mapping method was used to investigate the changes in the subsurface mechanical properties after shot peening. The Cp-Ti titanium alloy was produced using a hot press at a pressure of 45 MPa with a sintering time of 30 minutes at 950 °C. Afterward, the samples were shot-peened using stainless steel balls with dimensions between 600 µm and 1000 µm at 7 bar of pressure with a specially designed shot-peening system. Shot-peened samples were scanned for hardness under a load of 0.2 kg, and hardness distribution maps were generated using a Matlab®-developed algorithm to process the obtained hardness values. The applied microhardness mapping method clearly visualized the increase in surface hardness and the gradual decrease of this hardness increase towards the center of the shot-peened Cp-Ti alloy. It is concluded that the outputs of this study will be useful for the in-depth investigation of subsurface mechanical properties after shot peening for different alloy groups.

Keywords: Biomedical Titanium Alloys, Shot Peening, Indentation, Microhardness Mapping, Powder Metallurgy

1. Giriş

Biyomedikal uygulamalarda sıklıkla implantlar kullanılmakta ve kullanım alanları sürekli gelişmektedir. Nüfus artışı ve dünya nüfusunun yaşlanması implant malzemelerine olan ihtiyacı arttırmaktadır. Örneğin Şekil 1-a ve b’de verilen diş, diz ve kalça implantlarına duyulan ihtiyaç nüfus artışına paralel olarak artış göstermektedir. Ayrıca her yıl çok yüksek miktarda kalça ve diz implant işlemleri gerçekleştirilmektedir (Matuła, Dercz, & Barczyk, 2019; Rack & Qazi, 2006). Bununla birlikte gerçekleştirilen kalça implantlarının %12,8’i için daha sonra revizyon operasyonuna ihtiyaç duyulmaktadır. Bu durum uygun implant malzemesinin seçimi ve geliştirilmesinin önemini göstermektedir (Rack & Qazi, 2006). Paslanmaz çelik, kobalt alaşımları ve titanyum alaşımları gibi metalik implant malzemeleri biyomedikal alanda sıkça kullanılmaktadır. Bu metalik malzemeler arasında titanyum alaşımları, yüksek mukavemet-ağırlık oranları, üstün korozyon dirençleri, gelişmiş biyouyumlulukları ve yüksek yorulma dayanımları (Yamanoğlu, 2019; Yang et al., 2016) sebebiyle ortopedik implantlar ve protezlerde yaygın bir şekilde tercih edilmektedir (Sonntag, Reinders, Gibmeier, & Kretzer, 2013). Buna ek olarak, paslanmaz çelik ve kobalt alaşımlarıyla karşılaştırıldığında sahip oldukları düşük elastite modülü değerleri ve düşük yoğunlukları titanyum malzemelerin bu alanda kullanım potansiyellerini arttırmaktadır (Alshammari, Yang, & Bolzoni, 2019).

Titanyum alaşımlarının sahip olduğu üstün özelliklerine rağmen sınırlı aşınma direnci nedeniyle biyomedikal alanda kullanımları kısıtlanmaktadır. Ayrıca, kemik ve birlikte çalıştığı implant malzemesinin elastite modülü arasındaki farkın çok olması yükün implant malzemesi üzerinden taşınmasına sebep olmaktadır. Bu durum zaman içerisinde kemikte çelmeye ve implant



malzemesinin gevşemesine sebep olan gerilme kalkanı etkisine yol açmaktadır. İmplant malzemesi olarak kullanılan metalik malzemeler arasında titanyum alaşımlarının elastiste modülü kemik elastiste modülüne daha yakın olsa da titanyum alaşımlı implantların uzun süreli kullanımlarında bu etkinin ortaya çıkma riski bulunmaktadır. Bununla beraber, titanyum alaşımlarının sebep olduğu bakteri oluşumu da bu malzemelerin kullanımını kısıtlayıcı faktörler arasında sayılabilmektedir (Castillo, Muñoz, Trueba, Díaz, & Torres, 2019; Xu et al., 2020). Titanyum alaşımlarının biyomedikal uygulamalarda kullanılması için gerekli olan performans beklentilerini karşılama ve kullanımlarının güvenli olması gerekmektedir. İdeal ve uzun ömürlü implantlar, bakteriyel enfeksiyon, gevşeme, yorulma çatlakları ve aşınma kaynaklı kusurların önüne geçmek için insan dokusuyla uyumlu, yüksek korozyon direncine, biyoaktiviteye, gelişmiş yorulma direncine, bakterisidal aktiviteye ve uygun tribolojik özelliklere sahip olması gerekmektedir (E. Avcu et al., 2018; X. Cai et al., 2016; Cai, Ma, Zhou, Jiang, & Wang, 2016; K. Ma et al., 2016; Moskalewicz, Seuss, & Boccaccini, 2013; Sak et al., 2016; Sharma, Soni, & Bellare, 2009; Yanovska et al., 2014; Yildiran Avcu et al., 2020; Zujur et al., 2015).

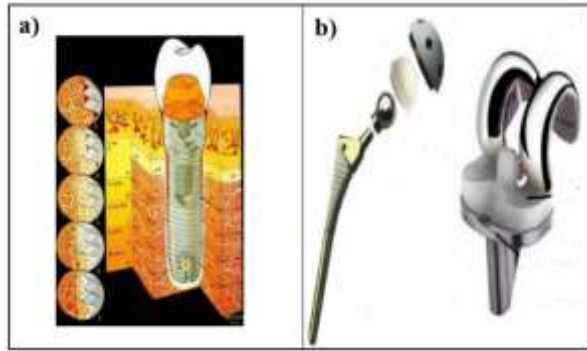

Şekil 1. a) Diş implantı, b) diz ve kalça implantı (de Viteri & Fuentes, 2013)

Mekanik, kimyasal ve biyolojik özelliklerinin geliştirilmesi amacıyla malzemelere yüzey modifikasyon yöntemlerinin uygulanmaktadır. Kimyasal ve mekanik yüzey modifikasyon yöntemleri ile malzeme yüzeylerine istenen yüzey desenlerinin kazandırılarak malzemelerin geliştirilmesi mümkündür (Ghosh & Abanteriba, 2016). Örneğin, yüzeyde desen oluşturma işlemi ile oluşturulan desenler yağlayıcılar için rezervuar görevi görmekte ve temas eden yüzeyler arasındaki film kalınlığını arttırmaktadır. Artan film kalınlığı sayesinde oluşan hidrodinamik basınç malzemelerin birbirine temasını azaltarak katı sürtünmeyi azaltmaktadır. Ayrıca yüzeyde oluşan desenler aşınma sırasında oluşan partikülleri yakalayıp üç elemanlı aşınmayı da azaltmaktadır. Buna ek olarak, yüzey deseni malzemelerin temas alanını azaltarak adezyonu da düşürmektedir (Ghosh & Abanteriba, 2016). Bu nedenle implant-insan vücudu etkileşimini etkileyebilecek mikro-modelleme ve yüzey topografyasının modifiye edilmesi işlemleri büyük önem taşımaktadır (E. Avcu et al., 2018).

Bilyalı dövme, genellikle bir nozuldan basınçlı havayla birlikte yüzeye bilya püskürtülmesi prensibiyle uygulanmaktadır (Şekil 2) ("Bilyalı Dövme Fotoğrafı"). Bilyalı dövme işlemi uygulanması kolay, düşük maliyetli (Kulekci & Esme, 2014) ve diğer yöntemlere göre çevre dostu bir yöntemdir.



Şekil 2. Bir dişli çark üzerine uygulanan bilyalı dövme işlemi ("Bilyalı Dövme Fotoğrafı,")

Yüzey modifikasyon teknikleri arasında bilyalı dövme, uygulandığı malzemelerde sertlik, dayanım, aşınma direnci, korozyon direnci ve yorulma ömrü gibi mekanik özelliklerini geliştirmek için önemli bir yöntemdir (Şekil 3). Bilyalı dövme birçok alanda kullanılabilir. Ancak özellikle, dinamik yükler altında çalışan malzemelerin yorulma dayanımlarını artırma amacıyla havacılık ve otomotiv alanlarında sıklıkla tercih edilmektedir (Chadwick, Ghanbari, Bahr, & Sangid, 2017).

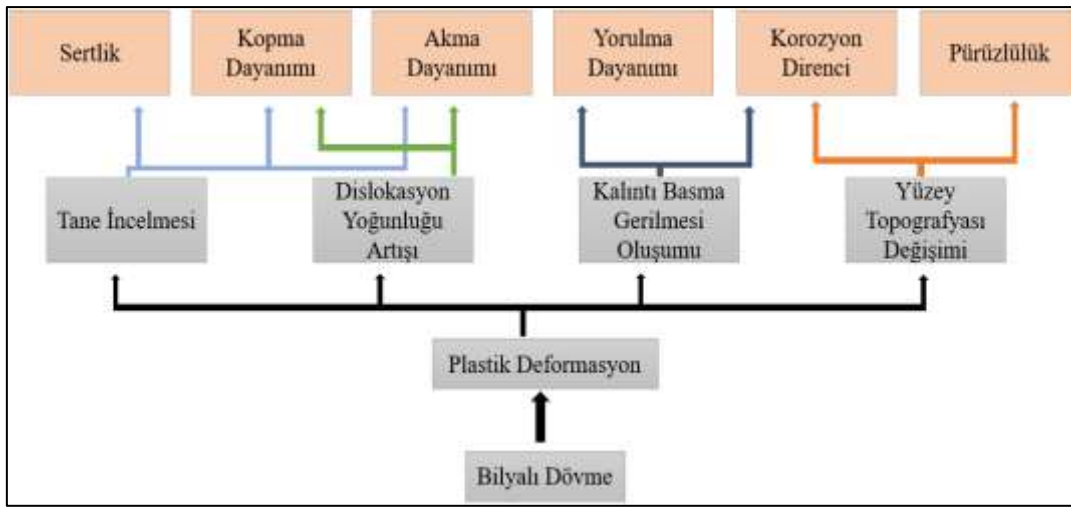

Şekil 3. Bilyalı dövmenin malzemelerin mekanik ve kimyasal özelliklerine etkisi

Bilyalı dövme işlemi sırasında yüzeye çarpan bilyaların kinetik enerjisi malzeme yüzeyine aktarılmaktadır. Bilyalar ve yüzey arasındaki bu etkileşim sonucunda malzeme yüzeyinde plastik deformasyonlar meydana gelmektedir (Şekil 4-a). Yüzeyde oluşan plastik deformasyonlar yüzey altı bölgede kalıntı basma gerilmesine sebep olmaktadır (Qin et al., 2022; Schulze, 2006). Yüzey altı bölgede oluşan kalıntı basma gerilmesi yüzeyde bulunan kalıntı çekme gerilmesini dengeleyerek çatlak başlangıçlarını engellemekte ve çatlak büyümelerini yavaşlatmaktadır (Ferreira, Ferreira, Antunes, Costa, & Capela, 2016; Qu, Duan, Hu, Jia, & Li, 2021; Xia et al., 2022) (Şekil 4-b). Bunun sonucunda malzemelerin yorulma dayanımlarını geliştirmektedir. Bilyalı dövme malzemelerin sertlik değerlerini de arttırmaktadır (Y. Y. Avcu et al., 2021; Sasikumar, Dineshkumar, Deeban, Sambathkumar, & Saravanan, 2020; Yildiran Avcu et al., 2020). Bilyalı dövme sonucu oluşan plastik deformasyon gerilme sertleşmesi mekanizmasına sebep olmakta ve malzemenin sertlik ve çekme dayanımı değerlerini arttırmaktadır. Buna ek olarak, plastik deformasyon ve dislokasyon hareketlerindeki artış sonucu yüzey ve yüzey altı bölgede tane incelmeleri ve yüzey pürüzlülüğünde artış görülmektedir (González, Bagherifard, Guagliano, & Fernández Pariente, 2017; Jamalian & Field, 2019; Zhang, Duan, Zhang, Wang, & Si, 2021) (Şekil 4-c). Bilyalı dövmenin malzeme özelliklerine etkisi göz önüne alındığında, biyomedikal titanyum alaşımlarının bilyalı dövme işlemi ile daha uyumlu ve performanslı hale getirilmesi literatürde önemli bir araştırma konusu olduğu anlaşılmaktadır.

Bilyalı dövmenin malzemelerin mekanik özellikleri üzerindeki etkisi bilyalı dövme parametreleri ile yakından ilgilidir. Bilyalı dövme işleminde malzemelerin mekanik özellikleri, bilya özelliklerinden (boyut, malzeme, şekil, sertlik vb.), işlem parametrelerinden (uygulama basıncı, bilya hızı, açısı vb.) ve çevresel faktörlerden etkilenmektedir (Jamalian & Field, 2019; Yildiran Avcu et al., 2020). Bu sebeple bilyalı dövme parametrelerinin doğru şekilde seçilmesi istenen malzeme özelliklerine ulaşılması açısından oldukça kritiktir.

Bilyalı dövme sonrası malzeme yüzey ve yüzey altı bölgelerindeki sertlik değişimlerinin tespitinde geleneksel sertlik test yöntemleri kullanılabilecek yöntemlerden biridir. Örneğin, Ongtrakulkij ve arkadaşları (Ongtrakulkij, Khantachawana, & Kondoh, 2020) Ti6Al4V alaşımına uygulanan ince taneli bilyalı dövme işleminde kullanılan bilyaların özelliklerinin malzemelerin yüzey ve yüzey altı bölgelerindeki sertlik değişimleri üzerindeki etkilerini incelemiştir. Çalışmada sertlik değerlerinin derinliğe bağlı olarak değiştiği (Şekil 5-a) ve derinlik arttıkça malzemelerin sertlik değerlerinde azalma meydana geldiği görülmüştür. En yüksek sertlik değeri (470 HV) ise silika bilyanın kullanıldığı bilyalı dövme işleminde elde edilmiştir.

Bir başka çalışmada Thomas ve arkadaşları (Thomas & Jackson, 2012) bilyalı dövme işlemi sırasındaki sıcaklığın malzemede oluşan plastik deformasyon mekanizmaları üzerindeki etkisini incelemiştir. Çalışma ticari saflıktaki titanyum ve α fazlı titanyum üzerinde gerçekleştirilmiştir. Malzemelerin sertlik değerleri Şekil 5-b'de verilmiştir. Sonuçlar incelendiğinde bilyalı dövme işlemi sırasında artan sıcaklığın plastik deformasyonu arttırdığı, artan plastik deformasyon malzemenin yüzey altı bölgesinde ikizlenme mekanizmalarını ve sertlik değerini arttırdığını belirlemiştir. Geleneksel sertlik testlerinin kullanıldığı çalışmalar hala devam ediyor olmasına rağmen günümüzde indentasyon esaslı metotların kullanımı giderek artmaktadır.

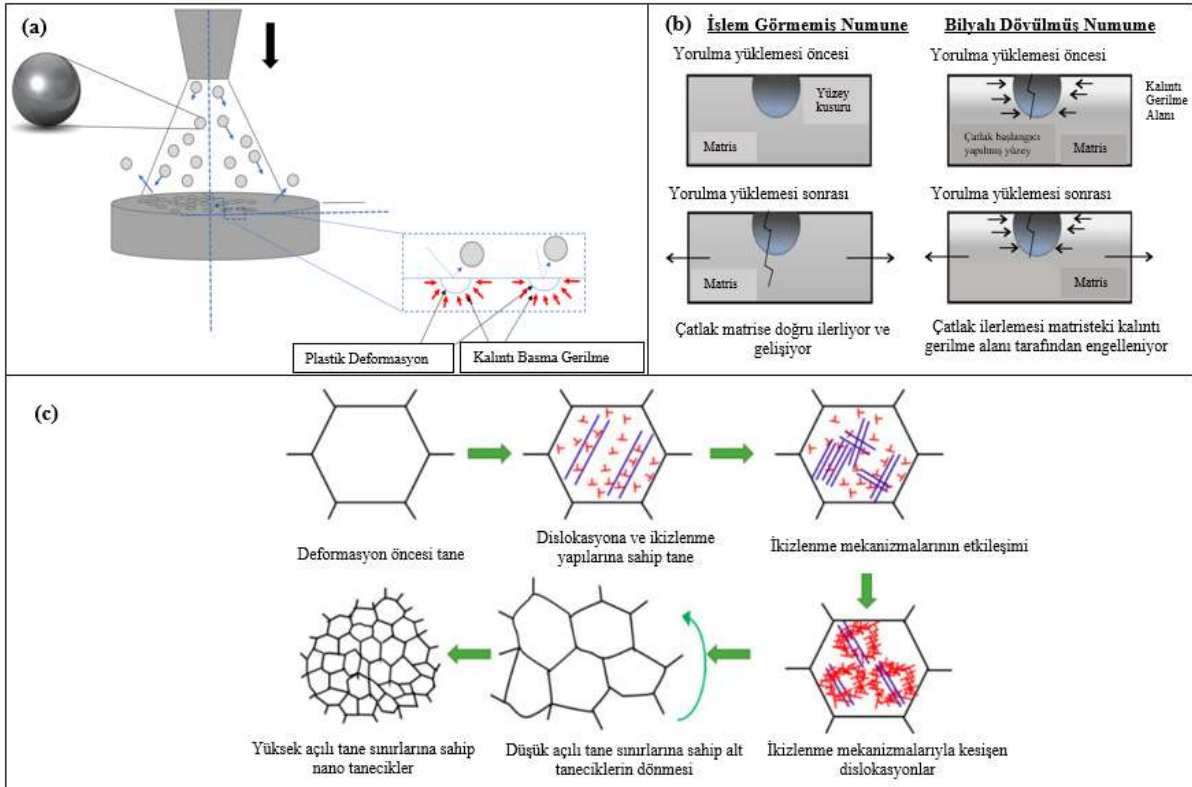

Şekil 2. a) Bilyalı dövme mekanizması, b) bilyalı dövmenin çatlak ilerlemesi üzerindeki etkisi (Chadwick et al., 2017), c) tane incilmesi mekanizması (John, Kalvala, Misra, & Menezes, 2021)

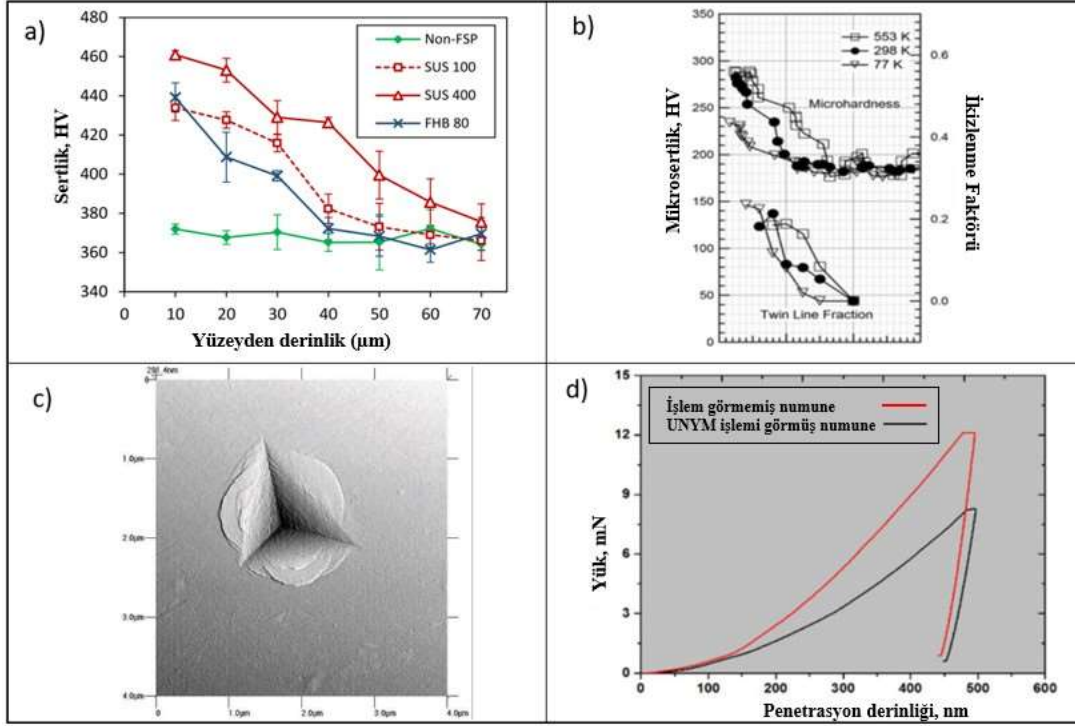

Şekil 3. a) Ti6Al4V alaşımının sertlik değerlerinin derinliğe bağlı değişimi (Ontrakulkij et al., 2020), b) mikrosertlik değerlerinin ve ikizlenme mekanizmaları sayısının sıcaklığa bağlı değişimi (Thomas & Jackson, 2012), c) Berkovich uç tarafından yüzeyde oluşturulmuş izin AFM görüntüsü (Sagadevan & Murugasen, 2014), d) yükleme-yer değiştirme grafiği (Amanov & Pyun, 2015)

Nanoindentasyon malzemelerin bölgesel mekanik özelliklerinin özellikle elastite modülü ve sertlik değerlerinin tespitinde sıklıkla kullanılan bir yöntemdir (Staszczyk, Sawicki, Kołodziejczyk, & Lipa, 2020). Nanoindentasyon yöntemi diğer yöntemlerle ölçümün çok zor olduğu küçük alanlarda da ölçüm yapılabilmesine olanak sağlamaktadır (Brayshaw, Roy, Sun, Akrivos, & Sherry, 2016). Bu sayede nanoindentasyon yöntemi kullanılarak mekanik özellik haritaları elde etmek mümkün olmaktadır. Ayrıca, uygulaması kolay ve ekonomik bir yöntemdir (BAŞOĞLU, 2009). Bu yöntemde sertlik ve elastite modülü gibi değerler batıcı ucun yükleme-yer değiştirme grafikleri kullanılarak tespit edilebilmektedir.

Sagadevan ve arkadaşları (Sagadevan & Murugasen, 2014) Berkovich ucunun Zr-Cu-Al alaşımlı malzeme üzerinde bıraktığı izi atomik kuvvet mikroskobu (AFM) kullanarak görüntülemiştir (Şekil 5-c). Amanov ve arkadaşları (Amanov & Pyun, 2015) bakır esaslı alaşımlara uygulanan yüzey modifikasyon tekniklerinin etkisini incelemek amacıyla uyguladığı indentasyon testi sonucu ortaya çıkan yükleme-yer değiştirme grafiklerini (Şekil 5-d) elde etmiştir.

Magazzeni ve arkadaşları (Magazzeni et al., 2021) ticari saflıktaki titanyum malzeme üzerindeki 19.044 noktadan yapılan ölçüm sonucu sertlik ve elastite modülü haritaları elde etmişlerdir (Şekil 6).

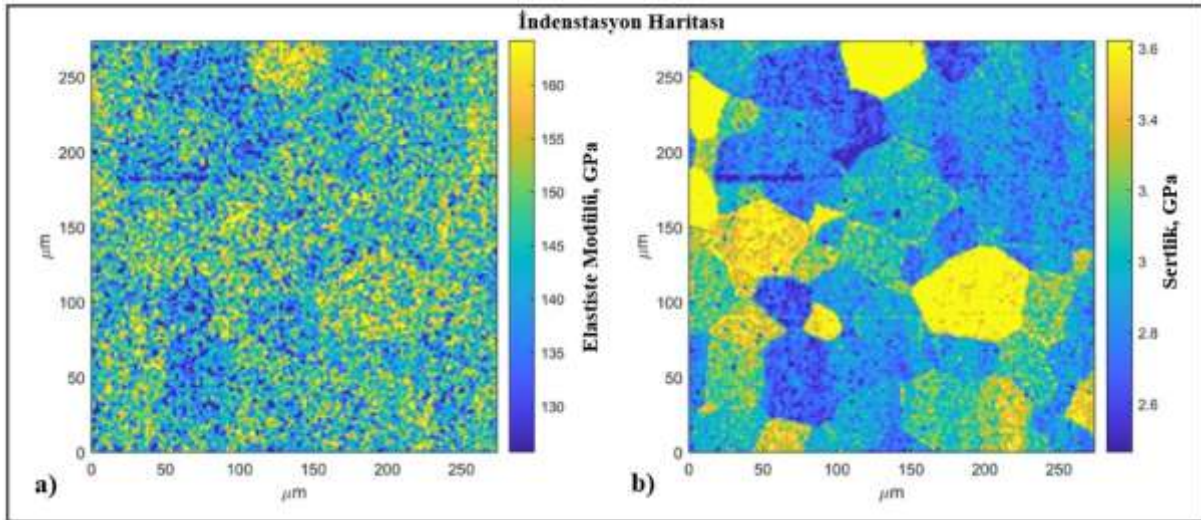

Şekil 4. Ticari saflıktaki titanyum alaşımının a) elastisite modülü, b) sertlik haritası (Magazzeni et al., 2021)

Literatür incelendiğinde, nanoindentasyon yönteminin bilyalı dövme sonrası değişen mekanik özelliklerin tespitinde de kullanıldığı görülmektedir. Örneğin, Ünal ve arkadaşları (Unal, Cahit Karaoglanli, Varol, & Kobayashi, 2014) farklı Almen şiddeti (A28-30, A30-32, A32-34, A34-36, C4-6, C6-8, C8-10 (mmA)) kullanarak bilyalı dövme işlemi uygulanmış ticari saflıktaki titanyum alaşımının sertlik ve elastisite modülü değerlerinin tespitinde nanoindentasyon yöntemini kullanmıştır. Çalışma, bilyalı dövme sonucu oluşan plastik deformasyona bağlı artan dislokasyon yoğunluğunu ve incelen tane oluşumunun malzemenin sertlik değerlerini arttırdığını göstermiştir. Ayrıca, artan Almen şiddeti ile malzemelerin sertlik değerlerinde de artış gözlemlenmiştir (Şekil 7-a).

Bir başka çalışmada Ma ve arkadaşları (X. Ma et al., 2021) β fazlı gradyan mikro yapılı $Ti_{10}V_2FeAl$ titanyum alaşımına rotasyonel hızlandırılmış bilyalı dövme uygulanmışlardır. Titanyum alaşımının bölgesel mekanik özelliklerini nanoindentasyon testi ile karakterize etmişlerdir. Nanoindentasyon testinde, 1 nN yükleme çözünürlüğü ve maksimum 10 mN yük ve batıcı uç olarak Berkovich uç kullanılmıştır. Çalışmalarından çıkan sonuçlar, bilyalı dövmenin tane incelmeye sebep olduğunu ve incelen tane yapısıyla beraber indentasyon derinliğinin düştüğünü göstermektedir (Şekil 7-b). Bu sonuçlardan, tane boyutunun malzemenin sertliği üzerinde büyük bir etkisi olduğu ve bilyalı dövme kullanılarak malzemelerin sertlik değerlerinin artırılabilirliği sonucuna ulaşılabilmektedir.

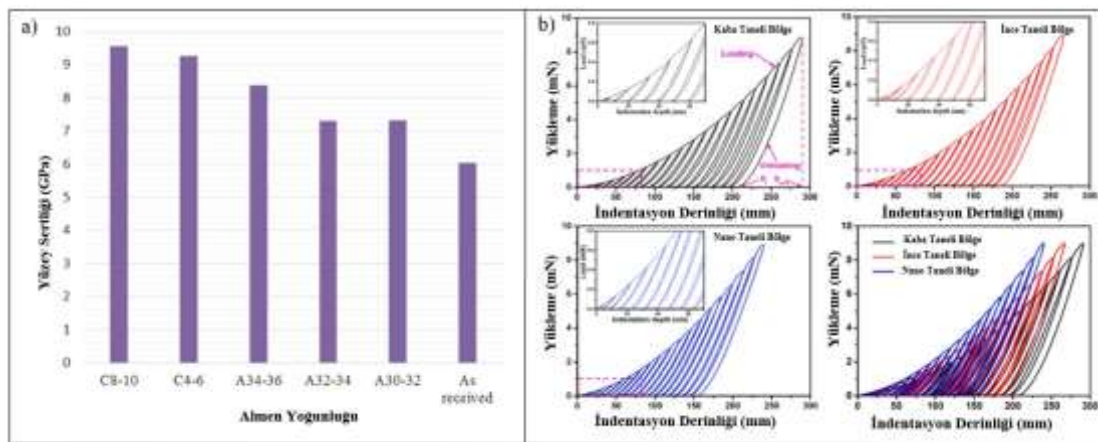

Şekil 5. a) Bilyalı dövülmüş numunelerin farklı Almen yoğunluklarına bağlı sertlik değişimleri (Unal et al., 2014), b) Yükleme-yer değiştirme grafikleri; (a) kaba tane bölgesi, (b) ince tane bölgesi, (c) nanoyapılı tane bölgesi (X. Ma, Chen, Lu, & Xiao, 2021)

Bu çalışmada toz metalürji yöntemiyle üretilmiş titanyum alaşımının bilyalı dövme sonrası değişen mekanik özelliklerinin incelenmesinde yenilikçi ve bu alanda daha önce kullanılmamış bir metot olan mikrosertlik haritalama kullanılmıştır. Elde edilecek sonuçlar ile mikrosertlik haritalama yönteminin bu alanda kullanım potansiyelinin ortaya konması amaçlanmıştır. Çalışma kapsamında, Cp-Ti numuneler son şekle yakın parçalar üretilmesine olanak sağlayan, gözenek miktarı kontrol edilerek istenen yoğunlukta malzemeler üretilebilen ve diğer yöntemlere göre daha çevreci bir yöntem olan toz metalürjisi yöntemi kullanılarak üretilmiştir. Üretilen numuneler, özel olarak tasarlanmış bilyalı dövme cihazında dövülmüş ve dövme işlemi sonrası yüzey ve yüzey altı bölgede değişen mekanik özellikler bir dizi ileri karakterizasyon yöntemleri kullanılarak incelenmiştir.

2. Materyal ve Metot

2.1. Toz metalürjik Cp-Ti alaşımının üretimi

Toz metalürjik Cp-Ti numunelerin üretiminde DIEX marka sıcak pres cihazı (Şekil 8) kullanılmıştır. Boyutları $33\mu\text{m} - 45\mu\text{m}$ aralığında değişen Ti tozları, $950\text{ }^\circ\text{C}$ sıcaklıkta 45 MPa basınç altında sinterlenerek 4 mm yüksekliğinde 20 mm çapında silindirik numuneler elde edilmiştir. Üretilen numunelerde oksitlenmeyi en aza indirmek için sinterleme işlemi vakum ortamında (10^{-4} bar) gerçekleştirilmiştir. Kalıplama yüksek elektriksel dirence sahip grafit kalıplar ile gerçekleştirilmiştir. Numune üretimi 10 dakika işlem sıcaklığına çıkış (ısıtma), 30 dakika $890\text{ }^\circ\text{C}$ 'de sinterleme ve 10 dakika soğutma olmak üzere toplam 50 dakikada tamamlanmıştır. Üretilen numunelerin yoğunlukları Arşimet prensibi kullanılarak yaklaşık %90 olarak ölçülmüştür.

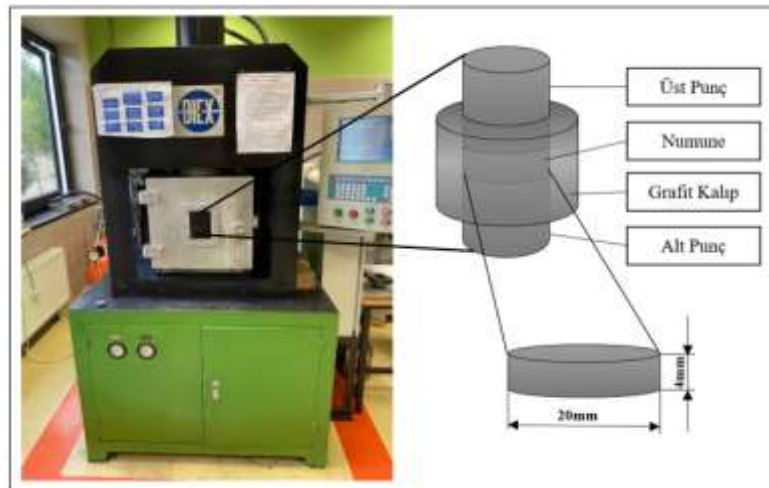

Şekil 6. Sıcak pres cihazı

2.2. Bilyalı dövme işlemleri

Toz metalürjik numunelerin yüzey modifikasyon işlemleri özel olarak tasarlanmış CNC kontrollü bilyalı dövme sistemi kullanılarak gerçekleştirilmiştir. Bilyalı dövme işleminde, boyutları 600 - 1000 μm arasında değişen, düzensiz şekillere sahip paslanmaz çelik bilyalar (Şekil 9), 7 bar basınçla 10 dakika boyunca numune yüzeyine uygulanmıştır. Bilyalı dövme numuneye dik açıyla ve 40 mm nozul-malzeme mesafesi kullanılarak gerçekleştirilmiştir. İşlem sonrasında numune yüzeyine saplanan bilyaların uzaklaştırılması amacıyla ultrasonik banyoda temizleme işlemi yapılmıştır.

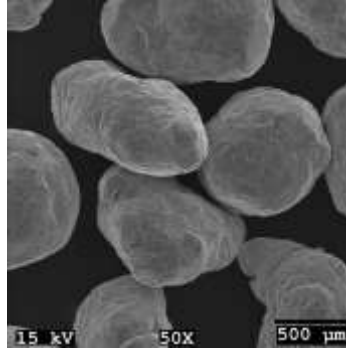

Şekil 7. Bilyalı dövme işleminde kullanılan bilyaların SEM görüntüsü

2.3.Mikrosertlik haritalama

Numuneler bilyalı dövme sonrası derinliğe bağlı olarak değişen sertlik değerlerinin elde edilmesi amacıyla hassas kesme cihazı ile kesilmiş, sırasıyla zımparalama ve parlatma işlemlerine tabi tutulmuştur. Parlatma işlemi sonrası Kroll çözeltisi (2 mL HF, 6 mL HNO, 92 mL H₂O) kullanılarak numunenin dağlama işlemi yapılmıştır.

Bilyalı dövmenin numunelerin sertlik değerleri üzerindeki etkisinin derinliğe bağlı değişiminin incelenmesi amacıyla numune kesit ara yüzeyine bir dizi sertlik testi uygulanmış ve sertlik değerleri belirlenerek sertlik haritaları oluşturulmuştur. Sertlik testleri ASTM E348-17 standartları altında, yüzeyden 30 μm mesafeden başlayarak, 0,2 kg yük altında, 10 saniye uygulama süresi kullanılarak mikro Vickers sertlik cihazı kullanılarak belirlenmiştir. Birbirini takip eden sertlik ölçümleri 100 μm mesafe bırakılarak gerçekleştirilmiştir ve 900 x 540 (μm²) dikdörtgen bir alan taraması yapılmıştır (Şekil 10). Elde edilen sertlik değerlerinden geliştirilmiş Matlab® programı yardımıyla sertlik haritaları elde edilmiştir (Brayshaw et al., 2016; Iakovakis, Avcu, Roy, Gee, & Matthews, 2022).

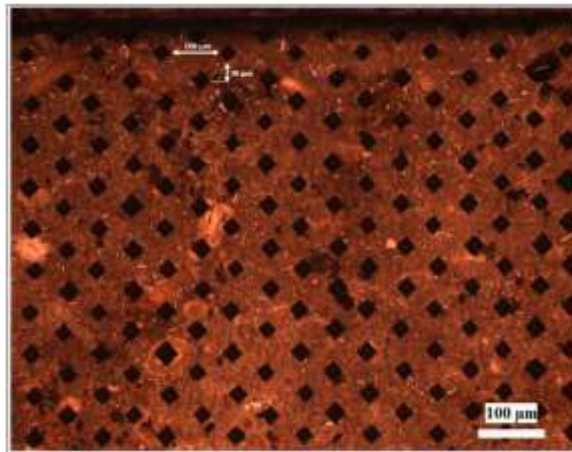

Şekil 8. Cp-Ti kesit sertlik taraması

3. Deneysel sonuçlar ve tartışma

Bilyalı dövme işleminde, malzeme yüzeyine çarpan bilyalar yüzeyde plastik deformasyona sebep olmaktadır. Şekil 11-a ve b'de bilyalı dövülen Cp-Ti numunenin işlem görmüş yüzeylerinin SEM görüntüleri verilmiştir. Şekil incelendiğinde yüzeye çarpan bilyaların etkisiyle malzeme yüzeyinde tepe ve çukurların oluştuğu, yüzey pürüzlülüğünün arttığı görülmektedir. Bilyalı dövme işleminde bilyaların oluşturduğu plastik deformasyon yüzeyde çeşitli boyutlarda krater oluşumuna neden olmaktadır (Qin et al., 2022; Schulze, 2006). Bununla beraber, yapılan deneylerde yüzeyde çarpmanın etkisiyle krater şeklinde yapıların oluştuğu ancak titanyumun düşük plastik deformasyon



kabiliyetine sahip olması nedeniyle bu yapıların oluşumunun tamamlanamadan çatladığı gözlemlenmiştir.

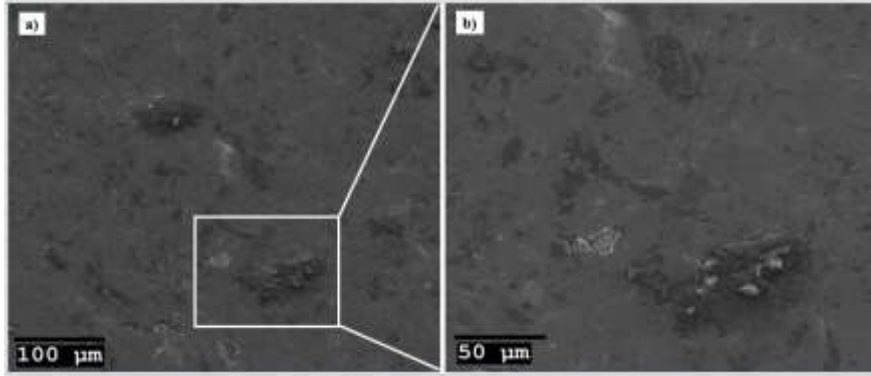

Şekil 9. Bilyalı dövülmüş Cp-Ti yüzeyinin SEM görüntüleri a) düşük büyütme, b) yüksek büyütme

Bilyalı dövme, malzemelerin yüzey altı özelliklerini de etkilemektedir. Bilyalı dövülmüş Cp-Ti numunenin kesitinin SEM ve optik mikroskop kullanılarak elde edilmiş görüntüleri Şekil 12-a ve b'de verilmiştir. Şekiller incelendiğinde malzeme yüzeyinde bilyaların yüksek enerjili ve tekrarlı şekilde çarpması sonucu gerçekleşen plastik deformasyonun yüzey altı bölgede çatlağa neden olduğu görülmektedir. Bunun yanı sıra yüzeye yakın bölgelerde (yaklaşık 250-300 µm) tane incelmeye ve tane yönelmesine neden olduğu gözlemlenmektedir.

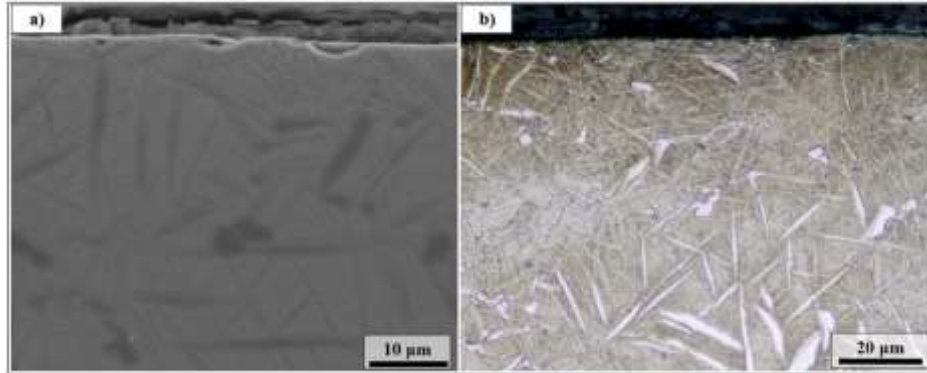

Şekil 10. Bilyalı dövülmüş Cp-Ti numunenin kesitinin a) SEM görüntüsü, b) optik mikroskop görüntüsü

Malzemede yüzey ve yüzey altı bölgede görülen bu sertlik artışında bilyalı dövme kaynaklı tane incelmeye, tane yönelmesi ve deformasyon sertleşmesi (pekleşme) mekanizmaları etkili olmaktadır. Yüzeyde gerçekleşen plastik deformasyon sonucu yüzey altı bölgedeki mikroyapı (Şekli 12-b) incelendiğinde bilyalı dövmenin etkisinin görüldüğü yerlerde tane sınırlarının arttığı, tane boyutlarının azaldığı gözlemlenmektedir. Tane sınırlarındaki artış ve tane incelmeye sebebiyle malzemede şekil değişimini sağlayan dislokasyon hareketleri engellenmekte ve malzemenin sertliği artmaktadır. Bunun yanı sıra yüzey ve yüzey altı bölgede gerçekleşen plastik deformasyon, deformasyon sertleşmesi mekanizmasına sebep olmakta ve malzemenin sertliğini arttırmaktadır.

Yüzey ve yüzey altı bölgede bilyalı dövme sonucu görülen değişimler malzemelerin mekanik özelliklerini yakından ilgilendirmektedir. Malzemelerin sertlik değerleri yüzey ve yüzey altı bölgede gerçekleşen değişimlerden ciddi şekilde etkilenmektedir. Sertlik dağılımının daha iyi anlaşılabilmesi amacıyla sertlik haritaları, özelleştirilmiş bir Matlab® kodunun güncellenmiş bir versiyonu kullanılarak görselleştirilmiştir (Brayshaw et al., 2016; Iakovakis et al., 2022). Şekil 13'te bilyalı dövülmüş Cp-Ti numunenin sertlik değerlerinin derinliğe bağlı olarak değişimi 2 boyutlu haritada verilmiştir. Harita incelendiğinde bilyalı dövmenin etkisinin görüldüğü bölgelerde ölçülen sertlik

değerlerinin dövme etkisinin görülmediği bölgelere göre yaklaşık %30 daha fazla olduğu anlaşılmaktadır. Bilyalı dövmenin etkisini kaybettiği bölgelerde malzemenin sertlik değerlerinin de işlem görmemiş numune değerlerine düştüğü gözlemlenmektedir.

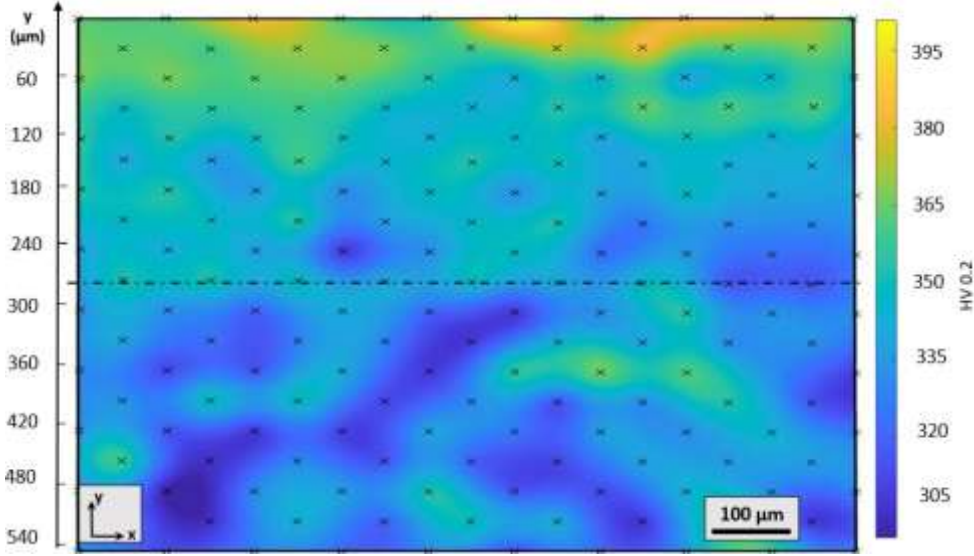

Şekil 11. Bilyalı dövülmüş Cp-Ti numunenin kesit sertlik haritası

4. Sonuç

Bu çalışmada bilyalı dövme işleminin biyomedikal titanyum alaşımların yüzey ve yüzey altı mekanik özellikleri üzerindeki etkisi incelenmiştir. Bu amaçla toz metalürjisi ile üretilen ticari saflıkta titanyum alaşımı (Cp-Ti) bilyalı dövme işlemine tabi tutulmuştur. Bu işlem sonrası numunelerin kesit mikroyapısı optik mikroskop ve SEM ile incelenmiştir. Ayrıca mikrosertlik yöntemi ve Matlab® üzerinde geliştirilen bir algoritma yardımıyla kesit sertlik haritaları çıkarılarak numunelerin sertlik dağılımı analiz edilmiştir. Gerçekleştirilen bu deneysel çalışmalar ile aşağıdaki sonuçlara ulaşılmıştır.

- Bilyalı dövme işleminde numune yüzeyine çarpan yüksek enerjili bilyaların, yüzeyde plastik deformasyona ve kısmi krater oluşumuna neden olduğu anlaşılmıştır. Bunun sonucunda da uygulandığı numunenin yüzey pürüzlülüğünü arttırdığı görülmüştür.
- Bilyalı dövme, uygulandığı numunenin yüzey altı bölgelerinde tane incelmeye neden olduğu görülmüştür. Bilyalı dövmenin etkisinin yüksek olduğu yüzeye yakın bölgelerde tane incelenmesinin daha yoğun olduğu anlaşılmıştır. Ayrıca tane yönelmelerinde değişimde tespit edilmiştir.
- Sertlik haritaları incelendiğinde yüzey ve yüzey altı bölgelerde sertlik değerlerinin yüksek olduğu ancak derinliğe bağlı olarak bu değerlerin azaldığı görülmüştür. Yüzey altı bölgede gerçekleşen tane inceliği, plastik deformasyon sonucu oluşan deformasyon sertleşmesi (pekleşme) ve bölgesel olarak porozitenin azalması ve yoğunluğun artmasına neden olmaktadır. Bu nedenle malzeme yüzeyinde sertlik artışı olduğu ortaya koyulmuştur. Bilyalı dövmenin derinliğe bağlı olarak etkisini kaybetmesiyle birlikte bu sertlik artışının kademeli olarak azaldığı anlaşılmaktadır.

Literatür incelendiğinde bilyalı dövülen malzemelerin değişen mekanik özelliklerinin indentasyon esaslı yöntemler kullanılarak haritalanması ve bu haritalar kullanılarak mekanik özellik-mikroyapı ilişkisinin incelenmesinin henüz sıklıkla çalışılmamış bir konu olduğu görülmektedir. Bu nedenle gelecek çalışmalarda bu konuların incelenmesinin bilimsel literatüre katkı sağlayacağı düşünülmektedir. Ayrıca gelecek çalışmalarda bilyalı dövmenin biyomedikal alandaki kullanımının



potansiyelini ilerletecek arařtırmaların yapılması da gerek bilimsel gerekse ticari açıdan önemli bir rol oynayabilecektir.

TEŐEKKÜR

Bu çalıřma Kocaeli Üniversitesi Bilimsel Arařtırma Projeleri Koordinasyon Birimi tarafından desteklenmiřtir. Proje Numarası: FBA-2021-2503.

KAYNAKLAR

- Alshammari, Y., Yang, F., & Bolzoni, L. (2019). Mechanical properties and microstructure of Ti-Mn alloys produced via powder metallurgy for biomedical applications. *J Mech Behav Biomed Mater*, 91, 391-397. doi:10.1016/j.jmbbm.2018.12.005
- Amanov, A., & Pyun, Y. S. (2015). A comprehensive review of nanostructured materials by ultrasonic nanocrystal surface modification technique. *The Journal of Engineering*, 2015(13), 144-149. doi:10.1049/joe.2015.0067
- Avcu, E., Yıldıran Avcu, Y., Bařtan, F. E., Rehman, M. A. U., Üstel, F., & Boccaccini, A. R. (2018). Tailoring the surface characteristics of electrophoretically deposited chitosan-based bioactive glass composite coatings on titanium implants via grit blasting. *Progress in Organic Coatings*, 123, 362-373. doi:10.1016/j.porgcoat.2018.07.021
- Avcu, Y. Y., Gonul, B., Yetik, O., Sonmez, F., Cengiz, A., Guney, M., & Avcu, E. (2021). Modification of Surface and Subsurface Properties of AA1050 Alloy by Shot Peening. *Materials (Basel)*, 14(21). doi:10.3390/ma14216575
- BAŐOĐLU, M. (2009). *VİCKERS İNDENTASYON DENEYLERİ İLE MALZEME ÖZELLİKLERİNİN TANIMI*. (Yüksek Lisans). Sakarya Üniversitesi, Bilyalı Dövme Fotođrafı. Retrieved from <https://osk-kiefer.de/en/technology-delivery-program/shot-peening>
- Brayshaw, W. J., Roy, M. J., Sun, T., Akrivos, V., & Sherry, A. H. (2016). Iterative mesh-based hardness mapping. *Science and Technology of Welding and Joining*, 22(5), 404-411. doi:10.1080/13621718.2016.1251713
- Cai, X., Cai, J., Ma, K., Huang, P., Gong, L., Huang, D., . . . Wang, Y. (2016). Fabrication and characterization of Mg-doped chitosan-gelatin nanocomposite coatings for titanium surface functionalization. *J Biomater Sci Polym Ed*, 27(10), 954-971. doi:10.1080/09205063.2016.1170416
- Cai, X., Ma, K., Zhou, Y., Jiang, T., & Wang, Y. (2016). Surface functionalization of titanium with tetracycline loaded chitosan-gelatin nanosphere coatings via EPD: fabrication, characterization and mechanism. *RSC Advances*, 6(9), 7674-7682. doi:10.1039/c5ra17109a
- Castillo, S. M., Muñoz, S., Trueba, P., Díaz, E., & Torres, Y. (2019). Influence of the Compaction Pressure and Sintering Temperature on the Mechanical Properties of Porous Titanium for Biomedical Applications. *Metals*, 9(12). doi:10.3390/met9121249
- Chadwick, D. J., Ghanbari, S., Bahr, D. F., & Sangid, M. D. (2017). Crack incubation in shot peened AA7050 and mechanism for fatigue enhancement. *Fatigue & Fracture of Engineering Materials & Structures*, 41(1), 71-83. doi:10.1111/ffe.12652
- de Viteri, V. S., & Fuentes, E. (2013). Titanium and Titanium Alloys as Biomaterials. In *Tribology - Fundamentals and Advancements*.
- Ferreira, N., Ferreira, J. A. M., Antunes, P. V., Costa, J. D., & Capela, C. (2016). Fatigue Crack Propagation in Shot Peened al 7475-t7351 Alloy Specimens. *Procedia Engineering*, 160, 254-261. doi:10.1016/j.proeng.2016.08.888



- Ghosh, S., & Abanteriba, S. (2016). Status of surface modification techniques for artificial hip implants. *Sci Technol Adv Mater*, 17(1), 715-735. doi:10.1080/14686996.2016.1240575
- González, J., Bagherifard, S., Guagliano, M., & Fernández Pariente, I. (2017). Influence of different shot peening treatments on surface state and fatigue behaviour of Al 6063 alloy. *Engineering Fracture Mechanics*, 185, 72-81. doi:10.1016/j.engfracmech.2017.03.017
- Iakovakis, E., Avcu, E., Roy, M. J., Gee, M., & Matthews, A. (2022). Wear resistance of an additively manufactured high-carbon martensitic stainless steel. *Sci Rep*, 12(1), 12554. doi:10.1038/s41598-022-15621-9
- Jamalian, M., & Field, D. P. (2019). Effects of shot peening parameters on gradient microstructure and mechanical properties of TRC AZ31. *Materials Characterization*, 148, 9-16. doi:10.1016/j.matchar.2018.12.001
- John, M., Kalvala, P. R., Misra, M., & Menezes, P. L. (2021). Peening Techniques for Surface Modification: Processes, Properties, and Applications. *Materials (Basel)*, 14(14). doi:10.3390/ma14143841
- Kulekci, M. K., & Esme, U. (2014). Critical analysis of processes and apparatus for industrial surface peening technologies. *The International Journal of Advanced Manufacturing Technology*, 74(9-12), 1551-1565. doi:10.1007/s00170-014-6088-9
- Ma, K., Huang, D., Cai, J., Cai, X., Gong, L., Huang, P., . . . Jiang, T. (2016). Surface functionalization with strontium-containing nanocomposite coatings via EPD. *Colloids Surf B Biointerfaces*, 146, 97-106. doi:10.1016/j.colsurfb.2016.05.036
- Ma, X., Chen, Z., Lu, W., & Xiao, L. (2021). Continuous multi-cycle nanoindentation behavior of a gradient nanostructured metastable β titanium alloy fabricated by rotationally accelerated shot peening. *Materials Science and Engineering: A*, 799. doi:10.1016/j.msea.2020.140370
- Magazzeni, C. M., Gardner, H. M., Howe, I., Gopon, P., Waite, J. C., Rugg, D., . . . Wilkinson, A. J. (2021). Nanoindentation in multi-modal map combinations: a correlative approach to local mechanical property assessment. *Journal of Materials Research*. doi:10.1557/s43578-020-00035-y
- Matuła, I., Dercz, G., & Barczyk, J. (2019). Titanium/Zirconium functionally graded materials with porosity gradients for potential biomedical applications. *Materials Science and Technology*, 36(9), 972-977. doi:10.1080/02670836.2019.1593603
- Moskalewicz, T., Seuss, S., & Boccaccini, A. R. (2013). Microstructure and properties of composite polyetheretherketone/Bioglass® coatings deposited on Ti-6Al-7Nb alloy for medical applications. *Applied Surface Science*, 273, 62-67. doi:10.1016/j.apsusc.2013.01.174
- Ontrakulkij, G., Khantachawana, A., & Kondoh, K. (2020). Effects of media parameters on enhance ability of hardness and residual stress of Ti6Al4V by fine shot peening. *Surfaces and Interfaces*, 18. doi:10.1016/j.surfin.2019.100424
- Qin, Z., Li, B., Zhang, H., Youani Andre Wilfried, T., Gao, T., & Xue, H. (2022). Effects of shot peening with different coverage on surface integrity and fatigue crack growth properties of 7B50-T7751 aluminum alloy. *Engineering Failure Analysis*, 133. doi:10.1016/j.engfailanal.2021.106010
- Qu, S., Duan, C., Hu, X., Jia, S., & Li, X. (2021). Effect of shot peening on microstructure and contact fatigue crack growth mechanism of shaft steel. *Materials Chemistry and Physics*, 274. doi:10.1016/j.matchemphys.2021.125116
- Rack, H. J., & Qazi, J. I. (2006). Titanium alloys for biomedical applications. *Materials Science and Engineering: C*, 26(8), 1269-1277. doi:10.1016/j.msec.2005.08.032
- Sagadevan, S., & Murugasen, P. (2014). Novel Analysis on the Influence of Tip Radius and Shape of the Nanoindenter on the Hardness of Materials. *Procedia Materials Science*, 6, 1871-1878. doi:10.1016/j.mspro.2014.07.218
- Sak, A., Moskalewicz, T., Zimowski, S., Cieniek, L., Dubiel, B., Radziszewska, A., . . . Lukaszczyk, A. (2016). Influence of polyetheretherketone coatings on the Ti-13Nb-13Zr titanium alloy's



- bio-tribological properties and corrosion resistance. *Mater Sci Eng C Mater Biol Appl*, 63, 52-61. doi:10.1016/j.msec.2016.02.043
- Sasikumar, K. S. K., Dineshkumar, K., Deeban, K., Sambathkumar, M., & Saravanan, N. (2020). Effect of shot peening on surface properties of Al7075 hybrid aluminum metal matrix composites. *Materials Today: Proceedings*, 33, 2792-2794. doi:10.1016/j.matpr.2020.02.676
- Schulze, V. (2006). *Modern Mechanical Surface Treatment*. Weinheim: WILEY-VCH.
- Sharma, S., Soni, V. P., & Bellare, J. R. (2009). Electrophoretic deposition of nanobiocomposites for orthopedic applications: influence of current density and coating duration. *J Mater Sci Mater Med*, 20 Suppl 1, S93-100. doi:10.1007/s10856-008-3490-6
- Sonntag, R., Reinders, J., Gibmeier, J., & Kretzer, J. P. (2013). Fatigue strengthening of an orthopedic Ti6Al4V alloy: what is the potential of a final shot peening process? In *Biomaterials and Medical Tribology* (pp. 217-237).
- Staszczyk, A., Sawicki, J., Kołodziejczyk, Ł., & Lipa, S. (2020). Nanoindentation Study of Intermetallic Particles in 2024 Aluminium Alloy. *Coatings*, 10(9). doi:10.3390/coatings10090846
- Thomas, M., & Jackson, M. (2012). The role of temperature and alloy chemistry on subsurface deformation mechanisms during shot peening of titanium alloys. *Scripta Materialia*, 66(12), 1065-1068. doi:10.1016/j.scriptamat.2012.02.049
- Unal, O., Cahit Karaoglanli, A., Varol, R., & Kobayashi, A. (2014). Microstructure evolution and mechanical behavior of severe shot peened commercially pure titanium. *Vacuum*, 110, 202-206. doi:10.1016/j.vacuum.2014.08.004
- Xia, B., Wang, B., Zhang, P., Ren, C., Duan, Q., Li, X., & Zhang, Z. (2022). Improving the high-cycle fatigue life of a high-strength spring steel for automobiles by suitable shot peening and heat treatment. *International Journal of Fatigue*, 161. doi:10.1016/j.ijfatigue.2022.106891
- Xu, W., Hou, C., Mao, Y., Yang, L., Tamaddon, M., Zhang, J., . . . Lu, X. (2020). Characteristics of novel Ti-10Mo-xCu alloy by powder metallurgy for potential biomedical implant applications. *Bioact Mater*, 5(3), 659-666. doi:10.1016/j.bioactmat.2020.04.012
- Yamanoglu, R. (2019). Antibacterial Properties of Stainless Steel Coated on Ti6Al4V Alloy. *International Journal of Mechanical and Production Engineering*, 7(9).
- Yang, W.-Z., Huang, W.-M., Wang, Z.-F., Shang, F.-J., Huang, W., & Zhang, B.-Y. (2016). Thermal and Mechanical Properties of Graphene–Titanium Composites Synthesized by Microwave Sintering. *Acta Metallurgica Sinica (English Letters)*, 29(8), 707-713. doi:10.1007/s40195-016-0445-7
- Yanovska, A. A., Stanislavov, A. S., Sukhodub, L. B., Kuznetsov, V. N., Illiashenko, V. Y., Danilchenko, S. N., & Sukhodub, L. F. (2014). Silver-doped hydroxyapatite coatings formed on Ti-6Al-4V substrates and their characterization. *Mater Sci Eng C Mater Biol Appl*, 36, 215-220. doi:10.1016/j.msec.2013.12.011
- Yildiran Avcu, Y., Yetik, O., Guney, M., Iakovakis, E., Sinmazcelik, T., & Avcu, E. (2020). Surface, Subsurface and Tribological Properties of Ti6Al4V Alloy Shot Peened under Different Parameters. *Materials (Basel)*, 13(19). doi:10.3390/ma13194363
- Zhang, Q., Duan, B., Zhang, Z., Wang, J., & Si, C. (2021). Effect of ultrasonic shot peening on microstructure evolution and corrosion resistance of selective laser melted Ti-6Al-4V alloy. *Journal of Materials Research and Technology*, 11, 1090-1099. doi:10.1016/j.jmrt.2021.01.091
- Zujur, D., Moret, J., Rodriguez, D., Cruz, L., Lira, J., Gil, L., . . . Alvarez-Barreto, J. (2015). A novel photocrosslinkable and cytocompatible chitosan coating for Ti6Al4V surfaces. *J Appl Biomater Funct Mater*, 13(3), e210-219. doi:10.5301/jabfm.5000227



DETERMINATION OF ENERGY SAVINGS WITH OPTIMUM INSULATION THICKNESS FOR DIFFERENT WALL COMPONENTS AND MODELS: HATAY CASE STUDY

**Gaye Bıyıklı
Fatih Ünal**

Mersin University, Engineering Faculty, Mechanical Engineering, Mersin, Turkey.

Abstract

It has become a necessity to use energy efficiently and economically due to the constantly increasing need for energy with the developing technology and the high cost of energy. Turkey is used a large part of energy in air conditioning, and the housing sector ranks second in energy consumption. So, the studies to be carried out are important effective use of energy and energy savings for residential. Considering the excess energy consumption and the expense of energy in the heating of houses, the efficient use of energy means that the savings will be great. One of the best saving methods that can be considered in buildings is thermal insulation. Besides, the damage caused by fossil fuels to the environment and the atmosphere can be reduced with the correct analysis of thermal insulation. In the study; the Optimum insulation thickness for two different insulation materials in wall models created by considering different wall components was determined by the degree-day method for Hatay province. Accordingly, the fuels used in the most preferred heating systems in Hatay province were selected and energy analysis was made. In this study, which was created by making comparisons among themselves, numerical results were obtained for two different insulation materials. It is thought that the results of the study will be beneficial in terms of reducing the environmental impact and using the different parameters affecting the thermal insulation in Hatay Province.

Keywords: Insulation, Optimum Insulation Thickness, Energy Saving, Hatay

Özet

Gelişen teknoloji ile birlikte sürekli artan enerji ihtiyacı ve enerji maliyetlerinin yüksek olması nedeniyle enerjiyi verimli ve tasarruflu kullanmak bir zorunluluk haline gelmiştir. Türkiye'de enerji tüketiminin büyük bir kısmı binaların iklimlendirilmesinde kullanılmaktadır. Konut sektörü enerji tüketiminde sanayi sektöründen sonra ikinci sırada yer almaktadır. Bu nedenle binalarda enerji tasarrufuna yönelik çalışmalar, enerji kaynaklarının etkin kullanımı açısından önemlidir. Isınma amaçlı tüketilen enerjinin toplam tüketim içindeki payı düşünüldüğünde, enerjinin verimli kullanılması sonucunda elde edilecek tasarrufun büyük olacağını göstermektedir. Binalarda en etkili enerji tasarrufu yöntemlerinden biri de ısı yalıtımıdır. Uygulanacak ısı yalıtımı enerji tasarrufunun yanı sıra fosil yakıtların çevreye ve atmosfere verdiği zararlardan kaynaklanan sera gazı emisyonlarını da azaltabilir. Bu çalışmada; Hatay ilinde farklı duvar bileşenleri kullanılarak oluşturulan duvar modelleri için seçilen yalıtım malzemelerinin optimum yalıtım kalınlıkları derece gün yöntemi ile belirlenmiştir. Buna göre Hatay ilinde en çok tercih edilen ısıtma sistemlerinde kullanılan yakıtlar seçilmiş ve enerji analizi yapılmıştır. Kendi aralarında karşılaştırmalar yapılarak değerlendirilen bu çalışmada farklı yalıtım malzemeleri için sayısal sonuçlar elde edilmiştir. Çalışma sonuçlarının, Hatay İlinde ısı yalıtımını etkileyen farklı parametrelerin çevresel etkisi en az ve en yüksek verimle binalarda kullanılması açısından faydalı olacağı düşünülmektedir.



Anahtar Kelimeler: Yalıtım, Optimum Yalıtım Kalınlığı, Enerji Tasarrufu, Hatay

1. INTRODUCTION

Today's rapid urbanization, increasing industrialization in our country and the world, and individuals' desire for a better life significantly increase energy consumption. The limitation of energy resources makes the efficient use of existing energy resources inevitable due to environmental problems arising from the senseless use of limited resources and dependence on foreign energy. Turkey's population and energy needs are constantly increasing and it is a developing country. While energy consumption is divided into four sectors as industry, housing, transportation and agriculture, the building sector constitutes 33% of the total energy consumption in Turkey (Kurekci, N. A., 2016). For this reason, choosing the right insulation material and insulation thickness for air-conditioning needs is of great importance when both operating and investment costs are taken into account for the construction sector, which has a significant share in Turkey's energy consumption (Aytac, A., & Aksoy, U. T., 2006). With this approach, many studies have been carried out to provide the most suitable insulation in residential buildings for different structural characteristics and climatic conditions. When these studies are evaluated, it is seen that many of them are investigating insulation material application, insulation material production, insulation application, insulation modelling and optimum thickness. (Koçyiğit, F., & Çay, V. V., 2019; Koçyiğit, F., & Çay, V. V., 2020; Koçyiğit, F., Ünal, F., & Koçyiğit, Ş. 2020; Akan, A. E., Ünal, F., & Koçyiğit, F. 2021;). It is possible to find many studies conducted for this purpose in the literature. For example, Aytac and Aksoy calculated the optimum insulation thicknesses for five different types of fuel (coal, natural gas, fuel oil, LPG, electricity) and two different types of insulation materials (expanded polystyrene, rock wool) for the province of Elazığ (Aytac & Aksoy, 2006). When coal and natural gas were used as fuel in their studies, Anber and Celik calculated the optimum insulation thickness, annual payback period and total cost analysis of buildings for the province of Hatay by using 5 different insulation materials (Anber & Celik, 2014). Rower et al. In their studies, the optimum insulation thickness for two different fuel types (natural gas, imported coal) and five different insulation materials (rock wool, glass wool, XPS, EPS and polyurethane) of an externally insulated wall model for 81 provinces were determined. they calculated the payment periods and the amount of savings (Kurekci et al., 2012). Golcu et al. calculated the optimum insulation thickness of the building exterior walls of Denizli by using life cost analysis (LCCA) in the calculations by using two different types of energy sources in heating and rock wool as insulation material (Golcu et al., 2006). Unal determined the optimum insulation thickness with the number of days for heating and cooling in buildings in the province of Mardin (Unal, 2020). In another study, Unal and Akan determined the optimum insulation thickness for different insulation materials according to heating and cooling conditions (Unal & Akan, 2021). Dasdemiir et al. examined the effect of optimum insulation thickness for buildings in İzmir on per capita energy savings and greenhouse gas emissions (Dasdemiir et al., 2018).

In this study, the optimum insulation thickness of XPS and rock wool insulation materials in the heating process for two different wall models for the province of Hatay, which is different from previous studies, was determined by using the 2022 degree-day values of Hatay province. Natural gas and fuel oil were used as fuel in the study. Depending on the values obtained, payback periods and greenhouse gas emissions were determined for each insulation material.

2. MATERIAL and METHOD

All calculations and analyzes made in this study were made for the province of Hatay, which is located in the 1st region of Turkey's climate geography. In the calculations, the heating degree-day value for the year 2022 for $T \leq 15$ °C was taken from Meteorology, and the heat losses on the outer



wall and the energy needs due to these heat losses were determined. Data from meteorology are shown in Table 1. (MGM, 2022).

Table 1. Meteorological data for Hatay province

Province	Climate Zone	Heating Degrees-Days HDD
Hatay	Zone 1	828

2.1 Building Exterior Wall Constructions

Although the building components vary in insulation applications in Turkey, two wall models are generally chosen an externally insulated wall and a sandwich-type wall. In this study, these two types of wall models were chosen to be examined to minimize the losses from the outer walls. The features of these different wall components and models are shown in Table 2 and Table 3.

Table 2. Thermal Resistance Calculations of Externally Insulated Wall Model

Model 1: Externally Insulated Wall			
Material	Thickness (m)	K (W/mK)	R (m ² K/W)
Interior Plaster (Cement Mortar)	0.02	0.51	0.0392
Vertical Hole Brick	0.19	0.45	0.4223
Exterior Plaster (Cement Mortar)	0.02	0.87	0.0230
R _{in}			0.1670
R _{external}			0.0454
R _{w, total} (wall layers excluding insulation material)			0.6969

Table 3. Thermal Resistance Calculations of Sandwich-Type Wall Model

Model 2: Sandwich Wall			
Material	Thickness (m)	K (W/mK)	R (m ² K/W)
Interior Plaster (Cement Mortar)	0.02	0.51	0.0392
Pumice Brick	0.15	0.60	0.2500
Pumice Brick	0.10	0.60	0.1667
Exterior Plaster (Cement Mortar)	0.03	0.87	0.0345
R _{in}			0.1667
R _{external}			0.0454
R _{w, total} (wall layers excluding insulation material))			0.7025

2.2 Calculation of Building Heating Energy Need

The heat loss that may occur per unit area on the outer walls is obtained with the following Equation 1.

$$q = U \times \Delta t \quad (1)$$



In the equation U ; represents heat transfer coefficient (W/m^2K) and is obtained with the help of Equation 2.

$$U = \frac{1}{R_{in} + R_{w,t} + R_{ins} + R_{external}} \quad (2)$$

Here, R_{ins} the thermal resistance of the insulation material, and it is calculated from the equations given below.

$$R_{ins} = \frac{x}{k} \quad (3)$$

In Equation 3, x is the insulation material thickness and k is the thermal conductivity of the insulation material. The catalogue specifications of the insulation materials used in this study are given in Table 4.

Table 4. Properties of Insulation Materials

Insulation Material	Thermal Conductivity(k) (W/m^2K)	C_{ins} (Insulation Cost) ($\$/m^2$)
XPS	0.031	180
Rock Wall	0.040	80

The annual energy requirement for heating shown with E_{year} can be calculated with Equation 4.

$$E_{year} = \frac{86400 \times HDD}{(R_{w,t} + R_{ins}) \times \eta} \quad (4)$$

2.3. Annual Energy Cost and Calculation of Optimum Insulation Thickness

When determining the optimum insulation thickness (x_{opt}), a lifecycle cost analysis should be done. While calculating cost of the total heating, the values given in Table 5 were used. For the calculation of financial values, the average of the last 5 years has been taken, and the inflation rate has been determined as 20% and the interest rate as 10%.

Table 5. Financial Values

Financial Values	Value
Interest rate, (i)	10%
Inflation rate, (g)	20%
PWF	6.6104
Lifetime (N)	10 years

The energy cost is calculated based on the present value factor and the determined lifetime. As a result, the total heating cost of an insulated building is calculated with the help of the equations given below, according to the lifecycle cost analysis method. The x_{opt} equation, which minimizes the cost of total heating, is also given below:

$$C_{ins} = c \times x_{opt} \quad (5)$$



$$C_{ins,total} = \frac{86400 \times DG \times c_{fuel} \times PWF}{(R_{w,t} + R_{ins}) \times H_u \times \eta} + C_y \times X_{opt} \tag{6}$$

$$X_{opt} = 293.94 \times \left(\frac{DG \times c_{fuel} \times PWF \times k}{H_u \times c_y \times \eta} \right)^{1/2} - k \times R_{w,t} \tag{7}$$

The chemical and other properties of the fuels used in the above formulas are given in Table 6.

Table 6. Fuels Used for Heating and Their Properties

Fuel	H _u (Lower Heat Value) (kJ/kg)	η (Efficiency)	C _{fuel} (Fuel Cost) (\$/kg)	Chemical Formula
Naturel Gas	34526000	0.93	0.3850	C _{1.05} H ₄ O _{0.034} N _{0.022}
Fuel Oil	40546000	0.80	0.7660	C _{7.313} H _{10.41} O _{0.04} S _{0.026} N _{0.022}

2.4. Payback Period

The net saving amount is calculated as follows, according to the life-cycle cost analysis method, where C_{total} is the total heating cost of the uninsulated building during its 10-years life.

$$A_{year} = C_{total} - C_{ins,total} \tag{8}$$

The payback period, where C_{year1} is the annual energy cost of heating for the unit surface in the uninsulated state and C_{year2} in the insulated state, is calculated via the following equation.

$$pp = \frac{C_{ins}}{C_{year1} - C_{year2}} \tag{9}$$

2.5. Calculation of Flue Gas Emission

The general combustion equations of coal and natural gas, which are the fuel types used, are given below.

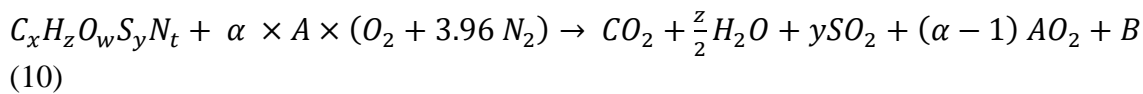

$$A = x + \frac{z}{4} + y - \frac{w}{2} \tag{11}$$

$$B = 3.76 \times a \times \left(x + \frac{z}{4} + y - \frac{w}{2} \right) + \frac{t}{2} \tag{12}$$

The amount of CO₂ emissions resulting from the combustion of 1 kg of fuel is calculated as follows.

$$m_{CO_2} = \frac{x \times CO_2}{m_{fuel}} \tag{13}$$

$$m_{fuel} = 12 \cdot x + z + 16 \cdot w + 32 \cdot y + 14 \cdot t \tag{14}$$

Calculation of the total gas emission to be released as a result of combustion;



$$m_f = \frac{HDD \times U}{H_u \times \eta}$$

(15)

$$m_{CO_2} = \frac{44x}{m_{fuel}} \times m_f$$

(16)

3. RESULTS

In this study, analyzes were made by considering two different wall models, two different fuels and two different insulation materials preferred for insulation in buildings in Hatay province. The Degree hour and life cycle cost analysis methods were used in the calculations for results. The results from the calculations are shown in Table 7 and Table 8..

Table 7. Data of results for the wall models

	Naturel Gas						FUEL OIL					
	XPS			Rock Wall			XPS			Rock Wall		
	X _{opt} (m)	A _{year} (\$/m ² -year)	PP (year)	X _{opt} (m)	A _{year} (\$/m ² -year)	PP (year)	X _{opt} (m)	A _{year} (\$/m ² -year)	PP (year)	X _{opt} (m)	A _{year} (\$/m ² -year)	PP (year)
Model 1	0.0031	5.33	5.96	0.0169	4.97	4.51	0.0157	9.52	4.25	0.0384	8.14	3.22
Model 2	0.0029	5.30	6.00	0.0167	4.95	4.54	0.0439	11.9	7.04	0.0381	8.12	3.24

Table 8. CO₂ emission data for the wall models

	Model 1			Model 2		
	Uninsulated	XPS	Rock Wall	Uninsulated	XPS	Rock Wall
Naturel Gas	7.84	6.94	5.26	7.88	6.94	5.26
Fuel Oil	7.60	4.79	3.63	7.64	2.91	3.63

4.DISCUSSION

The optimum insulation thicknesses obtained for natural gas or fuel oil are used in the externally insulated wall model as fuel during the heating season in Hatay province and the graphs of the changes in the costs obtained for each insulation material are given in Figure 1. When the graphics are examined, it should be taken into account that XPS is more suitable as an insulation material when comparing the two fuel types, but its cost is higher than rock wool.

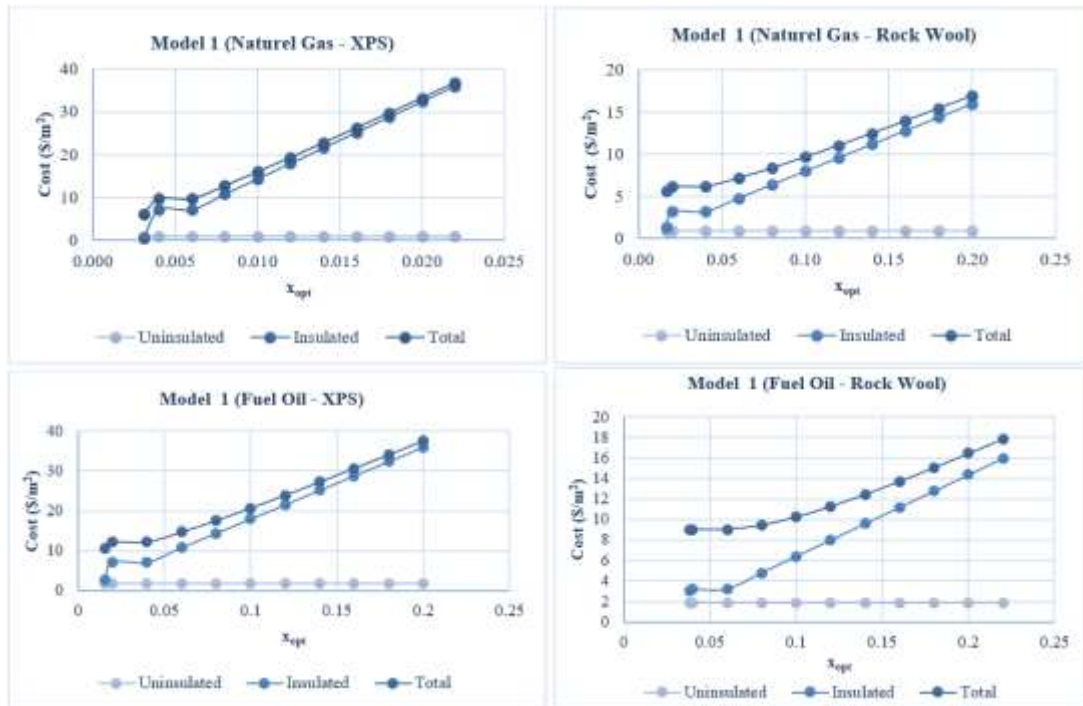

Figure 1. Results obtained for Externally Insulated Wall Model for Hatay Province

The optimum insulation thicknesses obtained when natural gas and fuel oil are used as fuel in the sandwich-type wall model during the heating season in Hatay province and the graphs of the changes in the costs obtained for each insulation material are given in Figure 2. When the graphics are examined, it is seen that XPS has the lowest insulation thickness when used with natural gas fuel.

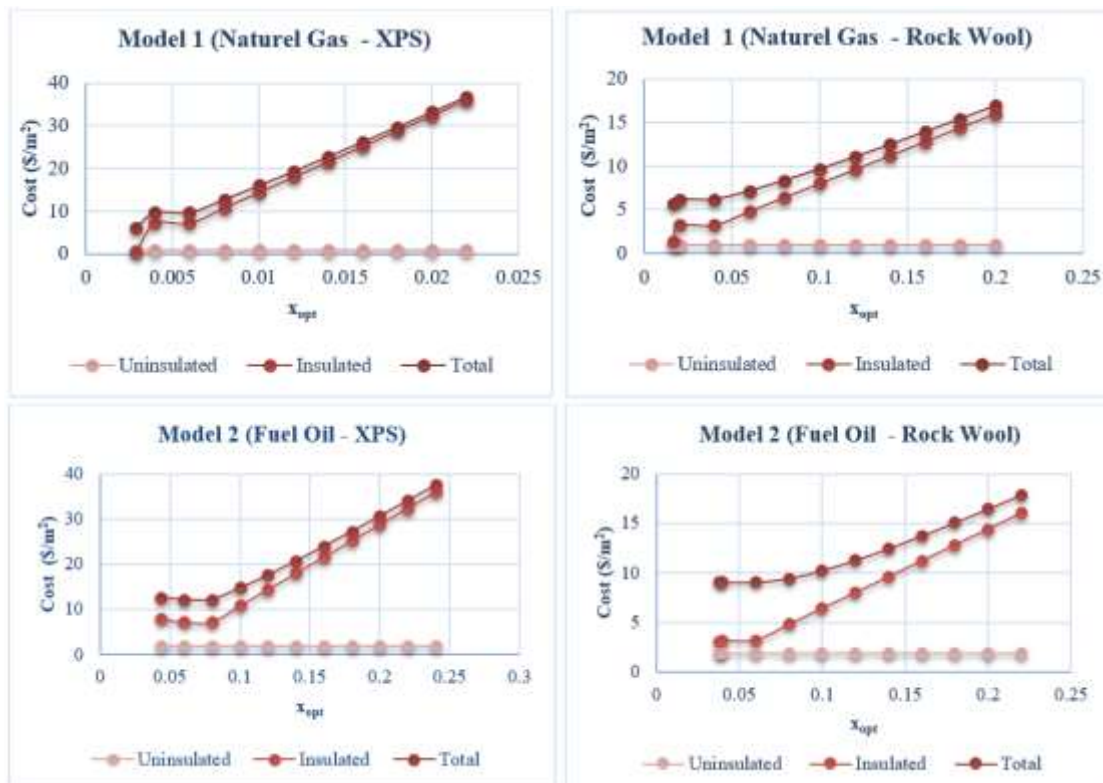

Figure 2. Results obtained for Sandwich-Type Wall Model for Hatay Province



In the study, the effect of insulation materials on the payback period depending on the optimum insulation thickness for the heating season is given in Figure 3. When Figure 3 is examined, it is seen that the fuel oil-rock wool combination is the most suitable for both the externally insulated and sandwich-type wall models.

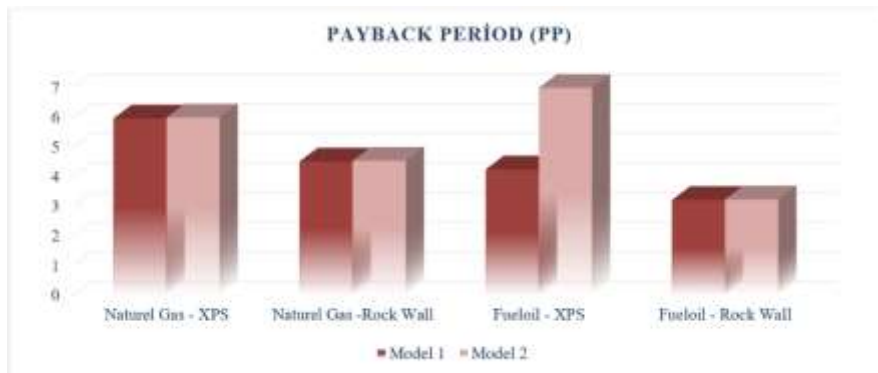

Figure 3. Payback Period Depending on Optimum Insulation Thickness

In the study, the CO₂ emission calculations for the externally insulated and sandwich-type wall models as a result of the flue gas emission calculations are given in Figure 4. In the externally insulated wall model, it has been determined that the CO₂ emission will be at lower levels when rock wool is used as the insulation material and fuel oil is used as the fuel type. For the sandwich-type wall model, it is seen that there is a very low level of CO₂ emission when the same fuel type but XPS is used as the insulation material.

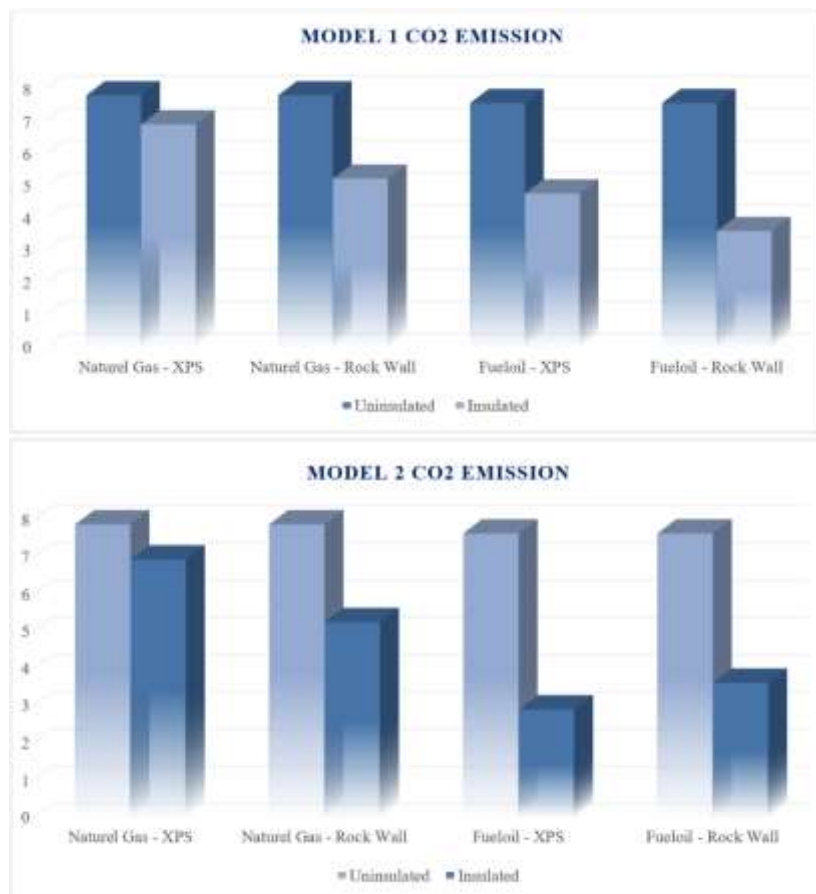

Figure 4. CO₂ Emission Amounts for Externally Insulated and Sandwich-Type Wall Models



5.CONCLUSION

According to the results obtained from the calculations, the lowest optimum insulation thickness values were determined as 0.29 cm when natural gas was used as the fuel type, sandwich-type as the wall model and XPS as the insulation material. Thus, it is more appropriate to use XPS in the sandwich-type wall model. In the externally insulated wall model, the lowest optimum insulation thickness values were determined as 0.31 cm when natural gas was used as the fuel type and XPS was used as the insulation material. When the payback periods are examined, the most appropriate payback period for both the externally insulated and sandwich-type wall models was calculated as 3.21 years. It is seen that insulated wall models have a lower CO₂ emission rate compared to non-insulated wall models. When all data are examined, it is thought that using XPS as an insulation material is more efficient because the payback period is low considering the cost. When considered from an environmental point of view, CO₂ emission decreases for each insulation application. According to the results obtained from this study, it is thought that the insulation on the exterior walls of the building will contribute to both the total cost, the annual gain and the prevention of flue gas emissions, depending on the exterior wall type.

6.REFERENCES

- Akan, A. E., Ünal, F., & Koçyiğit, F. (2021). Investigation of energy saving potential in buildings using novel developed lightweight concrete. *International Journal of Thermophysics*, 42(1), 1-28.
- Aytac, A., & Aksoy, U. T. (2006). The relation between optimum insulation thickness and heating cost on external walls for energy saving. *Journal of the Faculty of Engineering and Architecture of Gazi University*, 21(4), 753-758.
- Degree-day values of selected cities, <https://www.mgm.gov.tr/veridegerlendirme/gun-derece.aspx>
- Ertürk, M., Keçebaş, A., Çay, Y., Daşdemir, A., Coşkun, C. & Işık, E. 2018. The Effect on Energy Saving and Greenhouse Gas Emissions per Person of Optimum Insulation Thickness in Buildings: a case Study in İzmir/Turkey, *14th International Combustion Symposium (INCOS2018)*, 25-27 April, 348-356.TSE 825.
- Gölcü, M., Dombaycı, Ö. A. & Abalı, S., 2006. Denizli İçin Optimum Yalıtım Kalınlığının Enerji Tasarrufuna Etkisi ve Sonuçları, *Gazi Üniversitesi Mühendislik Mimarlık Fakültesi Dergisi*, Cilt 21, No 4, 639–644.
- Kurekci, N. A., Bardakcı, A. T., Cubuk, H. & Emanet, O. (2012). Türkiye'nin tüm illeri için optimum yalıtım kalınlığının belirlenmesi. *Tesisat Mühendisliği Dergisi*, vol.131, 5-21.
- Kurekci, N. A. (2016). Determination of optimum insulation thickness for building walls by using heating and cooling degree-day values of all Turkey's provincial centers. *Energy and Buildings*, 118, 197-213.
- Kocyiğit, S., & Cay, V. V. (2019). Investigation of mechanical and thermal behavior of basalt cutting waste (BCW) added clay brick. *European Journal of Technique (EJT)*, 9(2), 209-218.
- Kocyiğit, F., & Cay, V. V. (2020). The Effect of Natural Resin on Thermo-physical Properties of Expanded Vermiculite–Cement Composites. *International Journal of Thermophysics*, 41(10), 1-24.
- Kocyiğit, F., Unal, F., & Kocyiğit, S. (2020). Experimental analysis and modeling of the thermal conductivities for a novel building material providing environmental transformation. *Energy Sources, Part A: Recovery, Utilization, and Environmental Effects*, 42(24), 3063-3079.



INTERNATIONAL ASIAN CONGRESS ON CONTEMPORARY SCIENCES – VII

Thermal Insulation Rules in Buildings, Turkish Standards Institute, 1998

Unal, F. (2019). Condensation Analysis Of The Insulation Of Walls According To Different Locations In Mardin Province. *European Journal of Technique (EJT)*, 9(2), 253-262.

Unal, F. 2020. Determination of optimum insulation thickness in buildings by the number of heating and cooling degree-days, Mardin case study. *4th ASIA PACIFIC International Modern Sciences Congress*, 12-13 December, 591-599.

Unal, F. & Akan, A. E. 2021. Determination of optimum insulation thicknesses for different insulation materials as the case of heating and cooling conditions. *3rd International Conference On Innovative Studies Of Contemporary Sciences*, 19-21 February 230-237.



ARAP SOSYALİZMİ VE TÜRKİYE’DEKİ ETKİLERİ

Mehmet Korkud Aydın

Doç. Dr., Kırıkkale Üniversitesi, A.İ.İ.T. Bölümü, Kırıkkale, Türkiye

ORCID: 0000-0003-1645-7825

Özet

Arap sosyalizmi, Arapların Batı sömürgeciliğine karşı duydukları tepkinin bir sonucu olarak doğmuştur. Soğuk Savaş döneminde Sovyet Rusya ile Batı dünyasının arasında yaşanan rekabet Arap Milliyetçilerinin dikkatini çekmiş ve bu kimseler Batı sömürgeciliğine karşı Sovyet Rusya’yı önemli bir müttefik olarak görmüşlerdi. Ancak bu durum Arap devletlerinin tamamı için geçerli değildi. Zira Arap sosyalizmi, askeri cuntalar tarafından monarşiler yıkıldıktan sonra devlet ideolojisi haline gelmiştir.

Arap sosyalizmi, Arapların gelenekleri ve İslam dini ile uyumlu bir ideoloji olarak şekillenmiş olup devlet idaresinde seküler bir anlayışa sahipti. Temel kaynağı ise Arap milliyetçiliği idi. İlk olarak Mısır ve Suriye’de etkili olmuştu.

Nasır, Arap sosyalizminin en ateşli savunucusu olmuştur. Öyle ki Nasır, devrimci bir anlayışla hareket ederek Arap dünyasını monarşilerden kurtarmak gibi bir ideal geliştirmiş, bu yaklaşımının bir sonucu olarak, Arap dünyası genelinde saygın bir lider haline gelmiştir. Arap sosyalizmini siyasi bir kültür haline getiren bir diğer önemli yapı ise Suriye’de doğmuştur. Mişel Eflak ve Selahaddin Bitar, Baas Hareketini ortaya çıkaran isimler olmuşlardır. Neticede Baas hareketi farklı Arap ülkelerinde birbirinden bağımsız ancak benzer idealler çerçevesinde rejimi kontrol eden güçler haline gelmişlerdir.

Arap sosyalizmi, Ortadoğu ile tarihi ve kültürel bağları olan Türkiye Cumhuriyeti tarafından Sovyet yayılmacılığı ile eş değer bir tehdit olarak görülmüştür. Bununla birlikte Türk kamuoyunda etkili olan siyasi gruplar, Arap sosyalizmine karşı farklı yaklaşımlar geliştirmişlerdir. Türkçü- Milliyetçi gruplar I. Dünya Savaşı’nın acı tecrübeleri ve komünizme duydukları tepki sebebiyle Arap sosyalizmini düşman bir ideoloji olarak görmüşlerdi. İslamcı gruplar ise Arap milliyetçiliği ve sosyalizmini ümmetçi anlayışı yıkan bir kavram olarak değerlendirmişlerdi. Bu noktada Türk solunun genel olarak Arap sosyalizmine bir sempati ile yaklaştığı bilinmektedir. Nitekim bunun bir sonucu olarak özellikle radikal sol gruplar Arap sosyalistleri ile yakın bir ilişki kurmuşlardı.

Çalışmamızın amacı, Arap sosyalizminin tarihi gelişimini değerlendirerek Türkiye’de ki etkilerini izah etmektir. Çalışmamız hazırlanırken dönemin basın yayın kaynakları ve telif tetkik eserlerden faydalanılmıştır.

Anahtar Kelimeler: Arap sosyalizmi, Nasır, Türk Solu, Soğuk Savaş, Mısır



ARAB SOCIALISM AND ITS EFFECTS IN TURKEY

Abstract

Arab socialism emerged as a result of the Arab reaction to Western colonialism. During the Cold War, the rivalry between Soviet Russia and the Western world attracted the attention of Arab Nationalists. Nationalists were allied with Soviet Russia against Western colonialism. However, this approach was not valid for all Arab states. Arab Socialism has become a state ideology by the military juntas that overthrew the monarchies.

Arab socialism was an ideology compatible with the traditions of the Arabs and the religion of Islam. However the state was secular in terms of administration for Arab socialism. Its main source was Arab nationalism. First of all, it was effective in Egypt and Syria.

Nasser was the most ardent defender of Arab Socialism. Thus, Nasser developed an ideal of revolution to liberate the Arab nations from monarchies. As a result of his idealism, Nasser has become a respected leader throughout the Arab world. Another important movement that turned Arab socialism into a political culture emerged in Syria. Michel Eflak and Selahaddin Bitar were the names who founded the Baath Movement. As a result, the Ba'ath movement became a power to control the regimes that independent from each other but within the framework of similar ideals.

The Republic of Turkey, which has historical and cultural ties with the Middle East, saw Arab socialism as a threat equivalent to Soviet expansionism. However, political groups influential in Turkish public opinion had different approaches to Arab socialism. For Turkist-Nationalist groups, Arab socialism was a hostile ideology due to the negative experiences of World War I and their reaction to communism. Islamist groups evaluated Arab nationalism and socialism as a concept contrary to the understanding of the ummah. At this point, it is known that the Turkish left generally approaches Arab socialism with a sympathy. As a result, left-wing groups, especially those defined as radicals, established close relations with Arab socialists.

The aim of our study is to evaluate the historical development of Arab Socialism and to explain its effects in Turkey. While preparing our study, we benefited from the press resources of the period, as well as copyright and research works.

Keywords: Arab Socialism, Nasser, Turkish Left, Cold War, Egypt

Giriş:

II. Dünya Savaşı'ndan sonra İngiliz ve Fransız sömürgeciliğinin Ortadoğu'dan tasfiye edilmesi ile birlikte sömürge durumunda olan Arap ülkeleri bağımsızlıklarını kazanmaya başlamışlardır. Araplar devlet teşkilatlarını oluştururken, sömürge tecrübelerinin de etkisi ile Batı'ya karşı mesafeli bir duruş sergilemişlerdir. Bu durum Arap Milliyetçiliğinin güçlenmesine ve buna paralel olarak Arap sosyalizmi ile Bağlantısızlık gibi yeni fikirlerin ortaya çıkmasına sebep olmuştur (Sinkaya, 2011; 8 vd.)Şentürk, 2003; 49).

Soğuk Savaş döneminde, Arap dünyası da dünyanın geri kalanı gibi ABD ve Sovyet Rusya arasındaki rekabetten etkilenmiştir. Araplar arasında kimi gruplar, Batı dünyasını temsil eden kapitalist sisteme, sömürgeciliğe karşı olan tepkileri sebebiyle mesafeli bir tutum izlemişlerdir. Bu kimseler, Sovyet Rusya'nın sahip olduğu komünist ideolojiyi bir alternatif olarak görmüşlerdir. Bununla birlikte, Sovyet Rusya'nın ideolojik anlamda kontrolü altına girmek istemedikleri için de komünist/ sosyalist anlayışa kendilerince bir yorum getirmişlerdir. Böylece Arap sosyalizmi olarak bilinen yeni bir fikir doğmuştur (Aydın, 2019; 73 vd).



1. Arap sosyalizmi ve Arap sosyalizmini Benimseyen Devletler

Arap sosyalizmi, kısa süre içinde Arap coğrafyasında etkili bir ideoloji olmuştur. Başlangıçta Mısır ve Suriye’de kabul gören Arap sosyalizmi, Arapların milli ve manevi değerleri ile uyumlu bir görüntü arz etmiştir. İslam dininin temel değerlerini olduğu gibi kabul eden Arap sosyalizmi, devlet idaresindeyse laik bir anlayışa sahiptir. Devletçilik anlayışı doğrultusunda üretim vasıtalarının çoğunluğuna sahip olan devlet idaresi, vatandaşların miras ve özel mülkiyet haklarını da muhafaza etmiştir. Haliyle Arap sosyalizmi ile klasik komünizm, temel konularda birbirlerinden ayrılmaktadır (Şentürk, 2003; 49 vd.).

Cemal Abdülnasır’ın 1952’de Mısır’da darbe yolu ile iktidara gelmesi üzerine, Arap sosyalizmi bu ülkede bir yaşam alanı bulmuştur. Nasır, devrimci bir anlayış ile hareket etmiş ve Arap ülkelerini monarşi yönetimlerinden kurtarmak gibi bir ideal geliştirmiştir. Nasır’a göre Arapların geri kalmalarının temel sebebi sömürgecilik, sosyal adaletsizlik ve bunların hepsinin bir tezahürü olan monarşi yönetimleridir. Nasır, Arapların geri kalmışlıktan kurtulmaları için ise temelleri Arap milliyetçiliğine dayanan sosyalist bir devlet idaresinin kurulmasını bir zorunluluk olarak görmüştür.

Arap sosyalizminin önemli temsilcilerinden biri de Suriye’dir. Suriye’de bu fikri iktidara taşıyan ise Baas Partisi olmuştur. Arap sosyalizmi, Nasır ile büyük bir prestij kazanmış olsa da, bu hareket Suriye’de Mısır’dan daha önce güç kazanmıştır. Nitekim 1943 yılında kurulan “Arap Yeniden Diriliş Partisi” Suriye’de Baas Hareketi’ni ortaya çıkarmıştır. Arap sosyalizmi’nin ortaya çıkışında, Arap milliyetçiliğinde olduğu gibi Suriyeli Hristiyan Araplar etkili olmuşlardır. Selahaddin Bitar ve Mişel Eflak Arap sosyalizminin ilk ideologlarıdır (Özkoç, 2008; 34).

Baas ismi, ideologlarının Rönesans hareketinden ve Avrupa medeniyetinden örnek aldıklarını göstermektedir. Zira “Baas” ismi “yeniden diriliş” anlamına gelmektedir. Zeki Arsuzi de bu çıkarımı doğrular şekilde “El- Baas El- Arabi” unvanını kullanmıştır. Arap sosyalistleri, bu anlayış ile Arapların Avrupalı milletler gibi kültürel bir diriliş yaşayacağına inanmışlardır.

Arap sosyalizmini şekillendiren bir diğer gelişme ise, Mişel Eflak ile Selahaddin Bitar’ın, Zeki Arsuzi’nin “Yeniden Uyanış Partisi” ile birleşmesi idi. Bu parti ise 1953’te “Arap sosyalist Partisi” ile birleşmiştir. Suriye’de ki hareketin temel hedefi tüm Arapları, Arap milliyetçiliği ve sosyalizmi üzerine inşa edilmiş bir cumhuriyet idaresi etrafında birleştirmektir (İnce, 2017; 271 vd.).

Arap sosyalizmi, sömürgeciliği temsil ettiğine inanılan Kapitalizm gibi Marksizm’i de reddetmiştir. Kapitalizm veya Marksizm’in Arapların sosyal ve ekonomik sorunlarını çözemeyeceği iddiasında olan Mişel Eflak konu ile ilgili şunları söylemiştir; “*Marksizm milletlerin ve manevi değerlerin verdiği reddeder. Komünizm yıkıcıdır. Zira yeryüzüne bir cennet yaratacağı vaadiyle gelir. Hâlbuki bu cennet, mevcut toplumun yok edilmesinden sonra gelecektir. Yıkıcı bir diğer yönü de Arap kaderini Sovyetler Birliği’ne bağlama arzusunun ileri gelmektedir.*” Eflak’a göre Arap sosyalizmi, özellikle Batılı anlayışlardan bağımsız olarak Arap coğrafyasının kendi şartlarına göre şekillenmelidir (Özkoç, 2008; 41).

Arap sosyalizmini Klasik Marksizm’den ayıran şartlar, biraz da Ortadoğu’nun koşulları ile ilgilidir. Özellikle bölgedeki üretim alışkanlıkları ve mekanizmasının Batı dünyasından farklı olması bu ayrımı ortaya çıkaran şartların başında gelmektedir. Bu şartlar altında Arap sosyalizminin bir sınıf kavramı inşa etmesi mümkün değildir. Bu sebeple Arap sosyalizminin temelleri sınıf kavgası yerine sömürgecilğe karşı bir anlayış etrafında şekillenmiştir. Nitekim Arap sosyalizmi bir sınıf savaşı vermek yerine sömürgecilik karşısında tüm sınıfların bir iş birliği geliştirmesini hedeflemiştir. Marksizm Kapitalizme karşı bir kavga verirken, Arap sosyalizmi Kapitalizm doğrultusunda gelişen sömürgecilğe karşı bir mücadele içine girmiştir.



Arap sosyalizmi, kültürel ve dini konularda da Klasik Marksizm ile uyumsuzdur. Arap sosyalizmi, toplumun gelişmesini sağlayan tüm süreçleri maddi değerler ile izah eden materyalist anlayışa karşı çıkmış, Arap kültürü ile İslami değerleri kendi anlayışının içinde yaşatmayı denemiştir (Atay, 2000; 135). Arap sosyalizmi ile Klasik Marksizm pek çok konuda birbirlerinden farklı bir görüntü arz etseler de, uluslararası alanda Arap sosyalistleri ve Sovyet Rusya ittifak içinde hareket etmişlerdir. (Purtaş, 2007; 50).

Mısır, Arap sosyalizmini anayasa güvencesi altına alarak bu fikrin sadece bir parti politikası olarak kalmasının da önüne geçmiştir. 1962 yılında yürürlüğe giren “Misaku’l- ameli’l- Vatani” Arap sosyalizminin en önemli belgesi olmuştur. Bu belgede Arap toplumları için siyasal ve sosyal hürriyet kavramları gerçekleştirilmesi arzulan hedefler olarak ifade edilmişlerdir. Ayrıca “Arap sosyalist Birliği” de aynı yıl örgütlenmesini tamamlayarak faaliyete geçmiştir.

Nasır’ın devlet idaresinde takip ettiği politika, Arap sosyalizminin temel yaklaşımlarının anlaşılması için ayrıca önemlidir. Parti yönetiminde Marksistler çoğunlukta olsa da Nasır, kendisini asla komünist olarak tanımlamamıştır. Nitekim Nasır bu yaklaşımını iktidarda kaldığı müddetçe sürdürmüştür.

Nasır’ın vefatından sonra Arap sosyalizmi güç kaybetmiştir. Mısır’da iktidara gelen Enver Sedat, ülkesini Arap sosyalizminden uzaklaştırmıştır. Bu durum karşısında Arap sosyalizminin temsilcileri ise Irak ve Suriye’de iş başında bulunan Baas rejimleri olmuştur (Gürgün, 2009; 385 vd.).

Nasır’ın siyasi şahsiyeti etrafında Arap sosyalizmi kendisine, Ortadoğu’da çok sayıda taraftar bulmuştur. Arap toplumlarını monarşilerden kurtarma hedefi, krallıklarla yönetilen Arap toplumlarında heyecan uyandırmıştır. Bu yönü ile Nasır ve Arap sosyalizmi, Arap krallıklarındaki idareciler tarafından hiçbir zaman hoş karşılanmamıştır. Bununla birlikte bir Nasır, takip ettiği politikalarla ülkesini Arap dünyasının doğal lideri haline getirmeyide başarmıştır. Nitekim Mısır, günümüzde dahi, Arap Birliği’nin lideri konumundadır.

Arap sosyalizmi, Mısır ve Suriye dışındaki Arap ülkelerinde de yönetim anlamında bir yaşam alanı bulmuştur. Askeri darbeler ile kurulan cumhuriyet idareleri genel olarak Arap sosyalizmini benimsemişlerdir. 1958 yılında Irak’ta yaşanan darbenin ardından bu ülkede Baas rejiminin kurulduğu bilinmektedir. Nitekim Baas rejimi Irak’ta 2002 yılında yaşanan Amerikan işgaline kadar da devam etmiştir.

Devlet idaresinde Arap sosyalizmine yer veren ülkelerden biri de Libya’dır. Muammer Kaddafi 1969 yılında Libya’nın yönetimini askeri darbe ile ele geçirmiş ve öldürüldüğü 2011 yılına kadar kesintisiz olarak iktidarda kalmıştır. Nasır’ın fikirlerinden etkilenen Kaddafi, 1975 yılında kendine has görüşleri ile “Yeşil Kitap” adındaki üç ciltlik eserini yayınlamıştır. Yeşil Kitap, Libya’da Arap sosyalizmini devlet güvencesi altına alan bir belge özelliği taşımaktadır (Ronen, 2008, s.4 vd.).

Arap sosyalizminin Marksizm ve Kapitalizm’e bakışını olduğu gibi kabul eden Kaddafi, Yeşil Kitap içinde yer verdiği “3. Enternasyonal Teorisi” ile hem komünist hem de kapitalist kutuplara karşı Arap dünyasını birlik olmaya davet etmiştir. Bu yönü ile Kaddafi, Bağlantısızlık fikrinin de önemli bir savunucusu olmuştur. Kaddafi Arap sosyalizminin önemli bir temsilcisi olmakla birlikte, belirli konularda Mısır ve Suriye’den farklı bir yönetim anlayışı geliştirmiştir. Yönetimde şeriata yakın bir anlayışla hareket eden Kaddafi’nin bu yaklaşımı günümüzde “İslam Sosyalizmi” olarak da tanımlanmaktadır. Ayrıca Kaddafi ülkesinde meclisi de kapatmış ve halk komiteleri kurarak bir “halk iktidarı” kurduğunu iddia etmiştir (Caner ve Şengül, 2018; 52 vd.).

Arap ülkeleri arasında Cezayir ve Tunus’ta da sosyalizm etkili bir ideoloji olmuştur. Her iki ülke de Fransız sömürgecilikinden kurtulduktan sonra, yine bu ülkede eğitim almış kimseler marifeti ile Sosyalizm ile tanışmıştır.



Cezayir'in Fransa'ya karşı gerçekleştirdiği kurtuluş savaşı, Sosyalist kadrolar tarafından yönetilmiştir. 1962 yılında Fransız sömürgeciliğinden kurtulan Cezayir'de sosyalizm bu sebeple temel değer haline gelmiştir (Durdun, 1993; 492).

Cezayir'de tesis edilen sosyalist eğilimli rejim, Arap milliyetçiliği ve İslami değerleri de muhafaza etmiştir. Ancak 1965 yılında bir darbe ile iş başına gelen Hüvari Bu Medyen, 1970'li yıllarda sosyalist bir anlayışla devletleştirme siyaseti izlemeye başlamıştır. Medyen'in bu yaklaşımı ise ülkesindeki İslamcı gruplar tarafından tepki ile karşılanmıştır (Dayfallah, 1999; 64 vd.). Bu bilgiler ışığında Cezayir'de kabul edilen anlayışın Arap sosyalizminden farklı yönleri olduğu anlaşılmaktadır.

Tunus ise Fransız sömürgeciliğinden 1956 yılında kurtulmuş ve 1960'lı yıllarda Habib Burgiba marifetiyle sosyalist eğilimleri olan bir rejim ile tanışmıştır. Tunus'ta da Arap sosyalizmi etkili olmuş fakat bu ülkede rejim İslami bir yönetim anlayışından uzak durmuştur (Dursun, 2017; 140).

2. Türk Kamuoyunda Arap sosyalizmi

Türkiye ile Ortadoğu arasında tarihi ve kültürel anlamda bir bağ bulunmaktadır. Gerek bu bağlantı gerekse Türkiye ile Ortadoğu'da yer alan Arap devletleri arasındaki ilişkiler, Türk kamuoyunun bölge ile her zaman yakından ilgilenmesine sebep olmuştur. Türk kamuoyunu etkileyen ideolojik gruplar, Ortadoğu meselelerine kendi siyasi anlayışları doğrultusunda yaklaşmışlardır.

Arap sosyalizmine Türkiye'de ki sol/sosyalist grupların bakışına en önemli örnek, Yön Dergisi'nde yer alan yazılardır. Derginin 26. Sayısında yer alan Pierre D'istra imzalı tercüme yazı, derginin konuya yaklaşımına örnek olması bakımından önemlidir. D'istra "*Arap sosyalizminin Kaynakları*" isimli yazısında Arap sosyalizmi ile Arapların uyanışı arasında bir bağ kurmuş ve Arapların içinde bulunduğu durumu Avrupa'nın geçirdiği Rönesans sürecine benzetmiştir. D'istra yazısında konu ile ilgili olarak şunları söylemiştir; "*Nasıl demokrasiyi On sekizinci yüzyıl filozofları icat etmemişse, sosyalizmi de Marksizm icat etmemiştir. Nitekim Marksizm de böyle bir iddiada bulunmaz. Arap sosyalizmi sokaklar kadar eskidir. Doğrudan doğruya bizim etkimizde olduğunu sandığımız Doğu ihtilal hareketleri gerçekte bin yıllık ve bütün Arap tarihi boyunca kendini gösteren bir geleneğin mirasıdır.*"

D'istra'ya göre Ortadoğu, sosyalizm açısından da önemli bir coğrafyadır. Tarihte bilinen ilk doktriner sosyalist hareketin Basra Körfezi'nde 9. Yüzyıl'da gerçekleşen Karmat hareketi olduğunu iddia eden D'istra, Arap sosyalizmine tarihi bir anlam da yüklemiştir. D'istra'nın yaklaşımını ilginç kılan bir başka husus ise, İslamiyet'i bir din olmaktan ziyade milli Arap ruhunun bir tezahürü olarak değerlendirmesidir. Bu hususta D'istra şunları söylemiştir; "*Kuran o çağda vaktiyle İncil'de olduğu gibi olağanüstü bir reform gücü taşıyordu. Gerçekten de Kuran bütün insanların eşitliğini, bütün inançlılar topluluğunun kardeşliğini; yoksulun zengine, kalp dürüstlüğü'nün dünya hürsına üstünlüğünü ilan etmiyor muydu?*" (D'istra, 1962, 20 vd.)

Yön Dergisi'nde Arap sosyalizmini tanıtan çok sayıda yazı yer almıştır. Doğan Avcıoğlu konu ile ilgili makaleler yazan isimler arasındadır. Avcıoğlu, Nasır'ın Arap sosyalizmi marifetiyle Arapları birleştirme arzusunda olduğunu ve bu nedenle Nasır'ı desteklemenin sosyalizmi benimseyen bir Arap dünyasını desteklemek anlamına geldiğini söylemiştir. Avcıoğlu'na göre Nasır, Mısır ekonomisini uluslararası kapitalizmin etkilerinden kurtarmış, mali kurumları ve ticareti devletleştirmek suretiyle feodaliteyi Mısır'dan tasfiye etmiştir. (Avcıoğlu, 1963; 3)

Nasır'ı ve Arap sosyalizmini yakından takip eden Yön Dergisi'nde, Arap Birliği ile ilgili yayımlanan bir başka yazıda ise Arap sosyalizmi ile ilgili şu ifadeler yer verilmiştir; "*Nâsır'ın 'Milli Yasa' adındaki sosyalizm programının başarısı, Ortadoğu'nun ezilen ve sömürülen kitlelerini arkasından*



sürükleyebilir.” Ayrıca derginin 41-48. sayıları arasında peşpeşe, Nasır’ın “Milli Yasa” isimli ihtilal yasası yayınlanmıştır. Dergi Nasır ihtilalinin hedeflerini ise şu başlıklar ile okuyucularına sunmuştur; “Sömürgeciliği ve sömürgeciliği destekleyenleri, Mısırlı hainleri tasfiye etmek, Derebeyliği ortadan kaldırmak, Sermayenin iktidar üzerindeki egemenliğine son vermek, Toplumsal adaleti sağlamak, Güçlü bir milli ordu kurmak, Sağlam bir demokrasi hayatını kurmak...” (Altun, 2004; 562 vd.)

Türk kamuoyunda etkili gruplardan biri de İslamcılar idi. İslamcı grupların Arap sosyalizmine yaklaşımları genel olarak olumsuzdur. Bu yaklaşımının başlıca sebebi ise, Arap sosyalizmini İslam birliğinin önünde bir engel olarak görmeleridir. İslamcı gruplar Arap sosyalizmine tepkili olsalar da, Filistin Meselesi ve İsrail’in genel durumu karşısında Mısır ve Suriye gibi devletlerin konu ile ilgili politikalarını da desteklemişlerdir.

Akıncılar Dergisi’nde 1979 yılında yayınlanmış Akif İnan imzalı bir yazı, İslamcı grupların Arap sosyalizmi başta olmak üzere Ortadoğu’da etkili olan tüm ideolojilere yaklaşımlarını anlamak için önemli bir örnektir. Ziya’ül Hak’ın; “*Şeriat düzenin kurmak için Müslümanlar birleşin!...*” çağrısının altında yer alan yazıda, Osmanlı Devleti zamanında şekillenmiş –İslamcılık dahil- tüm ideolojilerin İslam birliğini parçalayan dış güdümlü fikirler olduğu iddia edilmiştir. Bu eleştiriler Soğuk Savaş döneminde ortaya çıkmış olan Arap sosyalizmi için de tekrar edilmiştir. Libya ve Suudi Arabistan gibi rejimleri birbirinden tamamen farklı iki devlet, bu yazıda örnek olarak ele alınmıştır. Buna göre sosyalizm veya kapitalizm ekseninde hareket eden bu devletler, İslam devleti değillerdir (İnan, 1979; 14 vd.).

Türkçü/ Milliyetçi grupların Arap sosyalizmine yaklaşımları ise, bu kimselerin Ortadoğu’ya ve komünizme bakışları ile bağlantılı olarak olumsuz bir görüntü arz etmektedir. I. Dünya Savaşı esnasında Ortadoğu ile ilgili toplum hafızasına kazınmış olan acı tecrübeler, Türkçü/ Milliyetçi grupların Ortadoğu’ya bakışlarını şekillendiren başlıca unsur idi. Ayrıca Cumhuriyetin ilanından sonra Türkiye’nin laik ve batıcı bir kimlik benimsemiş olması da bu grupların fikir dünyasını fazlasıyla etkilemiştir (Yıldız, 2019; 356 vd.).

Türkçü/ milliyetçi gruplar Komünizm ve Sosyalizme karşı her zaman eleştirel bir bakış açısına sahip olmuşlar ve bunları Türkiye Cumhuriyeti’nin bekasına yönelik tehditler olarak görmüşlerdir. Soğuk Savaş döneminin şartları ortaya çıktıktan sonra ise Türkçü/ milliyetçi gruplar, komünizmle mücadele gibi bir görev üstlenmişlerdir. Bu noktada en tehlikeli düşman ise Komünist Rusya olmuştur. Türkçü/ Milliyetçi gruplar Komünist/ Sosyalist fikirlerden beslenen rejimleri de aynı şekilde düşman olarak kabul etmişlerdir. Sonuç olarak Türkçü/ milliyetçi grupların Arap sosyalizmine karşı yaklaşımlarını belirleyen temel unsurlar, tarihten edinmiş oldukları tecrübeler ve komünizm ile sosyalizme duydukları öfke olmuştur (Toplu, 1978; 80 vd.).

Türkçü/ milliyetçi gruplar arasında Arap dünyasına yönelik yaklaşımlarda ise tam bir birliktelikten söz etmek mümkün değildir. Önemli bir Türkçü ideolog olan Hüseyin Nihal Atsız, Araplar ve İsrail arasındaki anlaşmazlıklar konusunda Arapları eleştiren bir tutum sergilemiştir. Bu yaklaşım Türkçü/ Milliyetçi grupların tamamı için gerekli değildir. Nitekim Türk-İslam sentezinin Türk siyasi hayatında kendine yer bulması ile birlikte Türkçü/ milliyetçi gruplar, Filistin Meselesi ve Arap- İsrail savaşları gibi konularda İslamcılar gibi Arapların lehine bir yaklaşım sergilemişlerdir. Bu noktada meselenin taraflarından biri olan Mısır’ın ve İsrail’e karşı bir mücadele içinde olan Filistin Kurtuluş Örgütü’nün Arap sosyalizmini benimsemiş olmaları da Türkçü/ milliyetçi gruplar tarafından göz ardı edilmiştir (Yıldız, 2019; 360).

Sonuç

Arap sosyalizmi, Batı sömürgeciliğine tepki olarak doğmuş bir ideoloji olup Arap milliyetçiliği ve Bağlantısızlık fikirleri ile uyumludur. En önemli temsilcileri Mısır ve Suriye’dir. Mısır lideri Cemal Abdülnasır, Arap toplumlarını monarşilerden ve geri kalmışlıktan kurtarmak için Arap sosyalizmini



bir araç olarak görmüştür. Nasır'ın bu yaklaşımı Arap dünyasında karşılık görmüştür. Askeri darbeler ile iş başına gelen kadrolar, Irak, Libya, Cezayir ve Tunus gibi ülkelerde Arap sosyalizmi ile uyumlu idareler kurmuşlardır.

Türkiye ile Ortadoğu arasında bulunan tarihi ve kültürel bağların bir sonucu olarak Türk kamuoyunda, Ortadoğu'da ki siyasi gelişmeler ve fikri hareketler yakından takip edilmiştir. Arap sosyalizmi de Türk kamuoyu tarafından değerlendirilmiş bir konudur. Sol/ Sosyalist gruplar Arap sosyalizmini, Kapitalizm karşısında mücadele eden ilerici bir fikir olarak değerlendirirken İslamcı gruplar, Arap sosyalizminin İslam dünyasını böldüğünü ve İslam birliğinin kurulmasının önünde bir engel olduğunu iddia etmişlerdir. Türkçü/ milliyetçi gruplar ise Arap sosyalizmine genel olarak Araplara yönelik olumsuz fikirleri ve Komünizme duydukları tepki çerçevesinde yaklaşmışlardır. Sonuç olarak Arap sosyalizmi, Türk kamuoyunda müstakil bir ideoloji olmaktan çok Sosyalizm ve Komünizm çerçevesinde değerlendirilmiştir.

Kaynakça

- Altun, Fahrettin (2004). “Kemalist Bir Modernleşme Yorumu Olarak Yön Dergisi”. *Türkiye Araştırmaları Literatür Dergisi*, Cilt:2, Sayı:1.
- Atay, Mehmet (2000). “Arap Baas Sosyalist Partisi Üzerine”, *Avrasya Dosyası*, Cilt: 6, Sayı: 1, Yıl: 2000, ss. 131-154.
- Avcioğlu, Doğan (1963). “Amerika ve Arap sosyalizmi”, *Yön Dergisi*, Sayı:61.
- Aydın, Mehmet Korkud (2019). “Ortadoğu'da İdeolojiler, Kimlikler ve Kuruluşlar”, Türkiye Ekseninde Ortadoğu (1918-1991) Olaylar, ideolojiler ve Kimlikler. ed. Mehmet Korkud Aydın, Berikan Yayınevi, Ankara.
- Caner, Cantürk, Şengül, Betül (2018). “Devrimler, Kaos ve İstikrar Arayışları İçinde Libya: Tarihsel ve Yapısal Bir Analiz”, *Uluslararası Afro-Avrasya Araştırmaları Dergisi*, Sayı: 6, ss. 45-70.
- D'İstra, Pierre (1962). “Arap sosyalizminin Kaynakları”, *Yön Dergisi*, Sayı:26.
- Dayfallah, Muhammed (1999). “Huvari Bu Medyen” *TDV İslâm Ansiklopedisi*, Cilt: 19, İstanbul, ss. 64-66.
- Dursun, Davut (1993). “Cezayir”, *TDV İslâm Ansiklopedisi*, Cilt: 7, İstanbul, ss. 489-494.
- Dursun, H. Rumeysa (2017). “Tunus'ta Otoriter Yönetim ve İslâmî Hareketin Doğuşu: Burgiba Dönemi Üzerine Bir Değerlendirme (1956-1987)”, *Türkiye Ortadoğu Çalışmaları Dergisi*, Cilt: 4, Sayı: 1, ss. 132-157.
- Gürgün, Hilal (2009). “Sosyalizm”, *TDV İslâm Ansiklopedisi*, Cilt: 37, İstanbul. ss. 382-388
- İnan, Akif (1979). “İslam Birliği Üzerine”, *Akıncılar Dergisi*, Sayı:7.
- İnce, Erdal (2017). “Suriye'de Baas Rejiminin Kuruluşu ve Türkiye”, *Tarih ve Günce, Atatürk ve Türkiye Cumhuriyeti Tarihi Dergisi*, Cilt: 1, Sayı: 1, ss. 261-280.
- Özkoç, Özge (2008). *Suriye Baas Partisi: Kökenleri, Dönüşümü, İzlediği İç ve Dış Politika (1943-1991)*, Mülkiyeliler Birliği Yayınları, Tezler Dizisi No: 17, Ankara.
- Purtaş, Fırat (2008). “Rusya ve Arap Ortadoğusu”, *Akademik Ortadoğu*, Cilt: 2, Sayı: 2, ss. 45-75.
- Ronen, Yehudit (2008). *Qaddafi's Libya in World Politics*, Lynne Rienner Publishers, Londra.
- SİNKAYA, Bayram (2011). “Geçmişten Günümüze Türkiye'nin Ortadoğu Politikası ve Batı Etkisi”, Adam Akademi, 2011/1, ss. 79-100.
- Şentürk, Doğan (2003). *Ortadoğu'da Arap Birliği Rüyası; Saddam'ın Baas'ı*, Alfa Yayınları, İstanbul.
- Toplu, Abdülhadi (1978). *Türk Milliyetçiliği ve Karşı İdeolojiler*, Töre-Devlet Yayınları, Ankara.



INTERNATIONAL ASIAN CONGRESS ON CONTEMPORARY SCIENCES – VII

Yıldız, İsmail (2019). “Türkiye’de ki İdeolojik Gruplar ve Genel Hatlarıyla Ortadoğu Meselelerine Bakışları”, Türkiye Ekseninde Ortadoğu (1918-1991) Olaylar, ideolojiler ve Kimlikler. ed. Mehmet Korkud Aydın, Berikan Yayınevi, Ankara.



KÖY ENSTİTÜLERİ HAKKINDA YAŞANAN SİYASİ VE İDEOLOJİK TARTIŞMALAR

Mehmet Korkud Aydın

Doç. Dr., Kırıkkale Üniversitesi, A.İ.İ.T. Bölümü, Kırıkkale, Türkiye

ORCID: 0000-0003-1645-7825

Özet

Cumhuriyetin ilanından sonra başlatılan yeni düzen çalışmalarını içinde eğitim ve öğretim faaliyetleri önemli bir yer tutmaktadır. 1924 yılında Tevhid-i Tedrisat Kanunu'nun yürürlüğe girmesi ile birlikte eğitim ve öğretim işlerinde birlik sağlanmış, 1928 yılında Latin Harfli Türk Alfabesine geçilerek memleket genelinde bir okuma-yazma seferberliği başlatılmıştır. Eğitim ve öğretim faaliyetleri konusunda ilk faaliyetler Millet Mektepleri ve Halkevleri bünyesinde gerçekleştirilen okuma- yazma kursları aracılığı ile gerçekleştirilmiştir. Bununla birlikte 1930'lu yıllarda özellikle kırsal kesimde eğitim çağındaki çocukların ancak yüzde 35'inin eğitim alabiliyor olması ve öğretmen açığının karşılanamaz boyutlarda olması devlet adamlarını yeni tedbirler almaya sevk etmiştir. 1935 yılında İsmail Hakkı Tonguç'un İlköğretim Genel Müdürlüğü'ne getirilmesi ile birlikte 1936 senesinde Köy Öğretmen Kursları açılmıştır. 1937 senesinde ise Köy Öğretmen Okulları açılmıştır. Köy Öğretmen Okulları 17 Nisan 1940 tarihinde Köy Enstitülerine dönüştürülmüştür. II. Dünya Savaşı sırasında Türkiye'nin siyasi ve ideolojik atmosferi Köy Enstitülerini de olumsuz etkilemiştir. Özellikle Hasan Ali Yücel'in Milli Eğitim Bakanı olarak görev yapıyor olması Köy Enstitülerini Türkçü- Turancı çevreler ile sol çevreler arasındaki ideolojik tartışmaların merkezi haline getirmiştir. Ayrıca Köy Enstitülerinin kırsal kesideki geleneksel yapıya tehdit oluşturduğunu düşünen kimi siyasi isimler de bu yapının kapatılması için yoğun uğraş vermişler ve konuyu TBMM gündemine taşımışlardır. Siyasi ve İdeolojik tartışmaların içine çekilen Köy Enstitüleri Demokrat Parti Hükümeti tarafından 27 Ocak 1954 tarihinde kapatılmıştır.

Anahtar Kelimeler: Köy Enstitüsü, İsmail Hakkı Tonguç, Türkçülük, Komünizm, Cumhuriyet Halk Partisi

POLITICAL AND IDEOLOGICAL DISCUSSIONS ABOUT VILLAGE INSTITUTES

Abstract

Education and training activities are very important in public arrangements made after the declaration of the Republic. With the enforcement of the Law on Unity of Education (Tevhid-i Tedrisat) in 1924, unity in education and training was achieved. In 1928, the Turkish Alphabet with Latin Letters was adopted and a literacy campaign was launched across the country. The first activities on education and training activities were literacy courses held within Nation Schools and Community Centers. In the 1930s, only 35 percent of children of education age, especially in rural areas, could receive education. In addition, the teacher deficit was unbearable. In the face of these conditions, statesmen had to take new measures. In 1935, İsmail Hakkı Tonguç was brought to the General Directorate of Primary Education. in 1936 Village Instructor Courses and in 1937 Village Teacher Schools were opened. Village Teacher Schools were transformed into Village Institutes on 17 April 1940. During the World War II, Turkey's political and ideological atmosphere also effected



Village Institutes negatively. Especially Hasan Ali Yücel's duty as Minister of National Education has made the Village Institutes the center of ideological debates between Pan Turkist groups and leftist groups. In addition, some political names who think that Village Institutes pose a threat to the traditional structure in rural areas have also worked to close this institution. The issue was also discussed in the TGNA agenda. The Village Institutes, which were drawn into political and ideological discussions, were closed by the Democratic Party government on January 27, 1954.

Keywords: Village Institutes, Ismail Hakki Tonguc, Turkism, Communism, Republican People's Party

1. Giriş

Eğitim bir toplumun gelişmesi için en önemli araçtır. Atatürk henüz Milli Mücadele devam ederken, 15 Temmuz 1921 tarihinde Maarif Kongresi'ni toplayarak eğitime verdiği önemi göstermiştir. Maarif Kongresinden sonra ise 8 Mart 1923 tarihinde Maarif Vekaleti tarafından Maarif Misakı hazırlanmıştır. Türkiye'nin eğitim politikalarını şekillendiren Maarif Misakı ile; ilköğretimin zorunlu olması, okuma yazma seferberliğinin başlatılması, milli bilinç ve heyecanın sağlanması için çalışılması gibi kararlar alınmıştır. Cumhuriyetin ilanının ardından ise 3 Mart 1924 tarihinde Tevhid-i Tedrisat Kanunu çıkarılarak arzu edilen laik ve çağdaş eğitimin hayata geçirilmesi sağlanmıştır (Aydın ve Aydın, 2016; 35 vd.).

Erken cumhuriyet döneminde Türkiye'de, milli eğitim politikasının çalışma alanlarından biri de kırsal bölgelerde yaşayan vatandaşların eğitilmesi meselesiydi. 1927 yılında gerçekleştirilen nüfus sayımına göre nüfusun yüzde 10'u okur-yazar idi. Kırsal kesimde ise bu oran sadece yüzde 6 idi. Köylerin yüzde 90'ında ise okul bulunmuyordu. (Kapluhan, 2012; 179 vd.). 1 Kasım 1928 tarihinde Latin alfabesinin kabul edilmesi ile birlikte yurt genelinde bir okuma-yazma seferberliğine girilmiş, 1 Ocak 1929 tarihinde ise Millet Mektepleri okuma-yazma eğitimlerine başlamıştır (Albayrak 1994, s. 472 vd.).

Türkiye, 1929 yılında başlayan ve tüm dünyayı etkileyen Büyük Buhranın bir sonucu olarak kendi kendine yeten bir ülke olmak için tedbirler almaya başlamıştır. Bu anlayış doğrultusunda tarımsal üretimin desteklenmesine ve üretimi artırmak için köylü nüfusun eğitilmesine karar verilmiştir (Varlı, 2012; 115.).

2. Köy Enstitülerinin Kuruluşu

1935 senesinde gerçekleştirilen CHP Büyük Kurultayı'nda köy ve köylüler ile ilgi takip edilecek plan ve politikalar belirlenmiştir. Böylece CHP'nin parti programında, kırsal kesimde gerçekleştirilecek eğitim ve öğretim uygulamaları açıklanırken tarım ile iş kolları da gözetilmiş ve; *“Köylerdeki okullarda sağlık, yaşayış ve içinde bulunduğu çevre şartları ile ilgili olan tarım ve zanaat fikirleri verilecektir”* denilmiştir. (CHP, 1935; 36) CHP Parti programında, kırsal alanda eğitim ve öğretim faaliyetlerini gerçekleştirmek üzere yeni bir okul kurulacağı da haber verilmiş ve bu hususta şu ifadeler kullanılmıştır; *“Köy çocuklarımıza kısa zamanda pratik hayat için lüzumlu bilgiyi verebilecek üç veya dört sömestirli köy okulları açılacaktır. Bunların, çocukları yükseköğretim derecelerine hazırlayan ilkokullardan ayrı bir tip olarak kurulup artırılması planlanacaktır. Bu tip köy okullarında çocukların daha olgun yaşta okumağa başlamaları ve okumanın arızasız devam etmesi ve bu işi devletin, askerlik borcu gibi, sıkı tutması lüzumludur”* (CHP 1935, s. 36-37). Ayrıca Parti programında, her köye bir okul açılmaması halinde *“yatı evleri”* kurulması ve nüfusu az olan köylerdeki öğrencilerin buralarda eğitim almalarının sağlanması hususu da yer almıştır. (CHP, 1935; 38 vd.)



Şerif Tekben, Hükümet emri ile 1935 yılından sonra köylerdeki yaşayışı ve eğitim durumunu yerinde görmek üzere çeşitli araştırma ve inceleme çalışmalarının gerçekleştirildiğini aktarmaktadır. Buna göre, Hükümet emri ile kurulan bir komisyon Kayseri, Çorum ve Yozgat'ın köylerinde çalışarak bir rapor hazırlamıştır. Daha önce konu ile ilgili hazırlanmış çalışmalara da yer verilen raporda; mali açıdan Türkiye'nin eğitim sistemini Batı dünyasından kopyalanmış bir modele dayandıracak gücü olmadığı vurgulanmış, yerli kaynaklara ve iş gücüne dayanan eğitim kurumlarının açılması gerektiği ifade edilmiştir (Tekben, 1962; 7 vd.).

Saffet Arıkan'ın Milli Eğitim Bakanlığı'na tayin edilmesi, köylerde gerçekleştirilecek eğitim ve öğretim faaliyetleri için bir dönüm noktası olmuştur. Konu ile ilgili bir diğer önemli isim ise aynı dönemde İlköğretim Genel Müdürlüğüne atanan İsmail Hakkı Tonguç'tur. Tonguç, Eskişehir Çifteler'de askerliğini tamamlamış ve okur-yazar olan gençlere yönelik bir kurs açmıştır. Kursu katılan gençler, dört aylık bir eğitimin ardından "eğitmen" unvanı ile köylere gönderilmişlerdir (Erdem, 2008; 192.) Uygulamanın sonuçları verimli olunca, 11 Haziran 1937 tarihinde "Köy Eğitmenleri Kanunu" çıkarılmıştır. Kanuna göre; Öğretmen bulunmayan az nüfuslu köylerde, eğitim-öğretim işlerini gerçekleştirmek ve tarımsal faaliyetlerin düzenli bir şekilde gerçekleştirilmesine rehberlik yapmak üzere köy eğitmenleri görevlendirilecektir. Köy Eğitmenleri, Ziraat ve Eğitim bakanlıklarının tarımsal faaliyetlere uygun olan çiftlik ve okullarda açılacakları kurslarda yetiştirileceklerdir. Öğretmenin bulunduğu köylerin birleştirilmesi ile bir bölge oluşturulacak ve bu bölgelere gezici bir öğretmen veya başöğretmen tayin edilecektir. (Resmi Gazete, 24 Haziran 1937).

1937 senesinde açılan Köy Eğitmen Kursları ile birlikte, köylerde ihtiyaç duyulan eğitim ve öğretim işlerini gerçekleştirmek amacıyla Köy Öğretmen Okulları açılmıştır. Bu okullar, Köy Eğitmen Kurslarında yetiştirilen eğitmenlerle ortaklaşa bir şekilde eğitim ve öğretim faaliyetlerini gerçekleştirmek amacıyla ilk olarak Eskişehir Çifteler ile İzmir Kızılcıullu'da açılmışlardır (Resmi Gazete, 14 Temmuz 1939) Bu okullar kısa süre içinde yurt geneline de yayılmışlardır.

Köylerdeki eğitim ve öğretim faaliyetlerinin sürdürülmesi açısından 17-29 Temmuz 1939 tarihleri arasında gerçekleştirilen Maarif Şurası'nda da önemli kararlar alınmıştır. Söz konusu bu kararlar Köy Enstitülerinin kuruluşu bakımından önem arz etmektedir. Nitekim bu toplantıda, köylerde gerçekleştirilen okuma-yazma eğitimlerinin arzu edilen sonuçlara ulaşamayacağı ifade edilmiş ve köylerde eğitim faaliyetlerini gerçekleştirmek üzere farklı konularda uzmanlıkları olan eğitimcilere ihtiyaç duyulduğu vurgulanmıştır. Bu ihtiyaç karşısında ise Köy Enstitülerinin kurulmasına karar verilmiştir. (Aysal, 2005; 272 vd)

Köy Enstitüleri'nin kuruluşu ile ilgili kanun TBMM tarafından 17 Nisan 1940 tarihinde kabul edilmiştir. Kanun 22 Nisan 1940 tarihinde Resmi Gazete'de yayınlanarak yürürlüğe girmiş ve yurt genelinde Köy Enstitülerinin kurulması için çalışmalara başlanmıştır (Resmi Gazete, 22 Nisan 1940)



3. Kamuoyunda Köy Enstitüleri

Köy Enstitüleri, kurulduğu tarihten itibaren Türk kamuoyunda çeşitli tartışmalara konu olmuştur. Enstitülerin varlığından özellikle toprak sahiplerinin rahatsız oldukları bilinmektedir. Ayrıca Köy Enstitüleri, kurucu kadroların ideolojik kimlikleri doğrultusunda siyasi/ideolojik tartışmalarında merkezinde yer almıştır. Köy Enstitüleri Demokrat Parti Hükümeti'nin bir tasarrufu olarak kapatılmış olsa da, Enstitülerin kapanış süreci 1947 yılında CHP Hükümeti tarafından, Türkiye'nin siyasi şartları doğrultusunda başlatılmıştır.

CHP İdaresi, II. Dünya Savaşı'nın ardından Sovyetler Birliği'nin Türkiye'yi tehdit eden bir politika izlemeye başlaması ile birlikte, memleket genelindeki solcu grupları bir milli güvenlik meselesi olarak görmeye başlamıştır. Bu durum karşısında kamuoyunda da bir sol/sosyalizm karşıtlığı yükselişe geçmiştir. Dönemin Milli Eğitim Bakanı Hasan Ali Yücel, bu karşıtlıktan etkilenen isimler arasındadır. Köy Enstitülerinin ülke genelinde yayılması ve etkili bir eğitim-öğretim faaliyeti gerçekleştirmesi konusunda önem arz eden Yücel, 1946 seçimlerinin ardından görevden alınmıştır. Yücel'in tasfiyesi ile Milli Eğitim Bakanlığı'na getirilen isim ise kamuoyunda muhafazakar kimliği ile tanınan Reşat Şemsettin Sirer'dir. Sirer'i konumuz için önemli kılan özelliği ise Köy Enstitülerine karşı takip ettiği politikadır.

Reşat Şemsettin Sirer Milli Eğitim Bakanı olduktan sonra, İsmail Hakkı Tonguç ve Ferit Oğuz Bayır gibi Köy Enstitüleri için önem arz eden kimseleri görevden almıştır. Ayrıca Sirer, Enstitülerin ödenek ve bütçelerini de azaltmıştır. Bununla birlikte Köy Enstitüleri bu dönemde faaliyetlerine devam edebilmiştir.

Köy Enstitülerinin varlığı ile ilgili yaşanan tartışmaların merkezinde komünizm meselesi yer almıştır. Buna göre, Köy Enstitülerinde komünizm propagandası yapılmakta, öğrencilere milli ve manevi değerlere uygun olmayan kitaplar okutulmakta idi. Milli Eğitim Müfettişlerinden Fethi İsfendiyaroğlu'nun hazırlamış olduğu rapor bu iddiaların temel dayanağı olmuştur. İsfendiyaroğlu'nun komünizm propagandası için kullanıldığını iddia ettiği kitaplar ise şunlardı; "Sosyalizm ve Sosyal Mücadelelerin Tarihi" (Max Beer), "Cesur Yeni Dünya" (Aldous Huxley), "Psikanaliz Teorisi" (Freud), "Demokrasi ve Sosyalizm" (Heroldlaski), "Tanrı" (Zühtü Uyar), "İnsanlığın Kurtuluşu" (Willem Van Loon) (Anık, 2006; 303 vd.)

Kamuoyunda Türkçü olarak bilinen isimler de Köy Enstitülerine tepki ile yaklaşmışlardır. Peyami Safa, Köy Enstitülerinde Nazım Hikmet şiirlerinin okutulmasını eleştirmiş, Nejdet Sançar ise bu okulları; "*Kızıl propagandanın yapıldığı fesat yuvaları*" olarak tanımlamıştır. 1946 senesinde güvenlik güçlerine Hasanoğlan Köy Enstitüsü ile ilgili olarak yapılan bir ihbarda ise şu cümleler kullanılmıştır; ; "*Hasanoğlan Köy Enstitüsünde milli bir cinayetin feci ve trajik hazırlıkları yapılmaktadır. Komünizm propagandası, İsmet İnönü'nün en çok bel bağladığı köy kalkınma davasının perdesi arkasında bir takım gizli ve müfrit unsurlar, oynayacakları rolün sonuçlarıyla meşguldürler. Ankara'da öğretmen, öğrenci olarak bulunan bazı solcular ve Hükümetçe malûm komünist temayüllü elebaşılar bu faaliyetin yazı, şiir ve kitap gibi vasıtalarla destekleyicidirler*" Söz konusu şikâyetle "elebaşı" olduğu iddia edilen kimseler ise; Behice Boran, Niyazi ve Mediha Berkes, Adnan Cemgil ve Sebahattin Ali gibi kamuoyunda sol/sosyalist kimlikleri ile tanınan yazarlardır.

Hasanoğlan Köy Enstitüsü ile ilgili yapılan ihbar kamuoyunun da dikkatini çekmiştir. Bunun üzerine dönemin İlköğretim Genel Müdür olan Yunus Kazım Köni, okula bir gezi düzenlemiştir. Köni'nin Enstitü ziyareti öğrenciler tarafından hoş karşılanmamış, Köni ile öğrenciler arasında bir tartışma yaşanmıştır. Köni'nin Enstitü öğrencilerine; "*Bizim de bir ideolojimiz var, biz nasyonalistiz*" demesi tartışmayı şiddetlendirmiştir. Köni'nin ardından Şemsettin Sirer de Enstitüye gitmiş ve öğrencilerle benzer bir tartışma yaşamıştır. Sirer karşılaştığı tepki üzerine; "*O halde ben sizi cerrahi ameliyata tutacağım, müdahale edeceğim.*" diyerek okuldan ayrılmıştır. Nitekim bu ziyaretlerin ardından Milli



Eğitim Bakanlığı tarafından Köy Enstitülerinin işleyişi ile ilgili önemli değişiklikler yapılmıştır (Dündar, 2003; 82 vd).

Kamuoyunda Köy Enstitülerini savunan isimler ise, tartışmaları haklı çıkarır şekilde, sol/sosyalist eğilime sahip kimseler olmuştur. Bu kimselere göre Köy Enstitülerini eleştirenler feodal düzeni savunmaktadırlar. Sol/Sosyalist grupların önemli temsilcilerinden biri olan Sebahattin Ali, 1947 senesinde Marko Paşa'da yer alan bir makalesinde Köy Enstitüleri ile ilgili yapılan eleştirilere cevaben şunları söylemiştir; *“İlköğretim seferberliği yapıldı. Memleketi kalkındırarak tek yol budur, dendi. Köy Enstitüleri'nde sahiden uyanık gençler yetiştirilecekti. Ümit verici adımlar atılmıştı. Bir de baktık, bu kültür yuvaları, eski medreselere rahmet okutan bir yobazlık baskısı altına alınıyor”* (Ali 2006, s. 19) Sabahattin Ali bir başka yazısında ise; *“On sekiz milyona irfan nurunu götürebilmek yolunu tutan, içeride ve dışarıda, dostun düşmanın hayran olduğu hür düşünce ve çalışma yuvaları, Köy Enstitüleri, atılan tırpanlarla, ortaçağ müesseseleri haline getirilmek üzere.”* (Ali, 2006; 167).

Köy Enstitüleri için önemli bir isim olan Hasan Ali Yücel ise, Emin Sazak'ın Köy Enstitülü gençlerin kendilerini Atatürk sandıklarını söylemesi üzerine; *“Arkadaşlar, Emin Sazak arkadaşımın oturduğu yerde içini çekmeğe hakkı vardır. Çünkü ilköğretim davası milletlerin rüşdünü ispat etme davasıdır. İlköğretim davası feodal sistemle kendisini idare etmek isteyenlerin samimi olarak istemeyeceği bir davadır.”* demiştir. (TBMM Tutanak Dergisi, 23 Mayıs 1945)

Köy Enstitülerinin işleyişi eleştirenler arasında, eskiden enstitülerde görev yapmış kimseler de bulunmaktadır. Pazarören Köy Enstitüsü'nde müdürlük yapmış Sabri Kolçak, Köy Enstitülerinde çalışan öğretmenlerin öğrencileri yetiştirecek donanımına sahip olmadıklarını, Enstitülerdeki öğrencilerin ise çalışma, barınma ve sağlık koşullarının yetersiz olduğunu iddia etmiştir. Kolçak'a göre Köy Enstitüleri; *“köy öğretmeni- şehir öğretmeni”* gibi sağlıksız bir ayrıma sebep olmaktadır. Ayrıca Kolçak, Enstitü öğretmenlerinin maaşlarının düşük olduğunu ve bu sebeple öğretmenlerin başka işlerle meşgul olarak asli vazifelerini yerine getiremediklerini de söylemiştir.

Kızılcıllı Köy Enstitüsü'nün ilk müdürü ve Demokrat Parti milletvekili olan Emin Soysal da, Enstitülerin işleyişini eleştirmiştir. Öğrencilerin çalışma koşullarının sağlıksız olduğunu iddia eden Soysal'a göre Enstitülerin ihtiyaçlarını karşılamak için yürütülen faaliyetler, öğrencilerin ruh, beden ve bilgi açısından gelişmelerini olumsuz yönde etkilemektedir. (Altunay, 2005; 101)

Köy Enstitüleri ile ilgili tartışmalar, bu kurumların kapatılmasının ardından da devam etmiştir. 1963 senesinde Türk Solu Dergisi'nde Süleyman Üstün'ün, Köy Enstitülerinin kapatılmasını sorgulayan bir yazı yazısına yer verilmiştir. Bu yazı, içeriği itibari ile Köy Enstitüleri ile komünizm arasında bir bağ olduğunu savunanların da elini güçlendirecek mahiyettedir. Üstün, konu ile ilgili yaklaşımlarını şu cümleler ile izah etmiştir; *“Köy Enstitüleri, zamanın egemen sınıfları tarafından, yapmacık bir duygululuk, sahte bir köycülük- halkçılık ve halka yukarıdan bakarak bunlar da okusunlar, diyen efendilik biçimliliği içinde kurulmuştur. Gerçek amaç ise: Tarihi zorunluluk gereğince er- geç bilinçlenip, uyanacak halkımızı, köylümüzü; egemen sınıflar yararına onlardan yana bilinçlendirmek zorunlu uyanışı gerçekleştirmektir.”* Üstün, İsmail Hakkı Tonguç'un bu maksatla girilen *“oyunu”* bozduğunu ve Köy Enstitüsünü farklı bir çizgiye taşıdığını söylemiştir. Üstün, Tonguç'un uygulamaları karşısında devlet adamların tutumunu ise şu cümlelerle yorumlamıştır; *“Bu planda Tonguç ve yakın arkadaşları, iyi hesaplanamamışlardır. Köyden gelen, köyün derterleriyle yüklü köy çocuklarını kendi sınıfsal çıkarlarına araç edemeyenler, sonradan öz Anadolu çocuklarını ve onları toplumcu bir biçimde eğiten öğretmenlerini en adice en iğrenç en haksız suçlamalarla suçlamaktan ve sonunda da Enstitüleri kapatmaktan geri kalmamışlardır.”* (Üstün, 1963; s.6)



4. Köy Enstitülerinin Kapatılışı

Kamuoyunda ve TBMM’de yaşanan tartışmaların bir sonucu olarak Köy Enstitüsü Öğretim Programı ve Yönetmeliği 1947 senesinde değiştirilmiştir. Hazırlanan yeni yönetmelik ile öğrencilerin görev ve sorumlulukları da düzenlenmiştir. Buna göre öğrenciler artık okul idaresine katılmayacaklardır. Ayrıca, öğrenciler iş eğitime de tabi tutulmayacaklar ve Enstitülerden mezun olan öğrencilere arazi tahsisi yapılmayacaktır. Söz konusu bu düzenleme, Köy Enstitülerinin temel amaçlarını kaybetmesine sebep olması bakımından oldukça olan önemlidir. 1950 senesinde de Enstitülerdeki karma eğitime son verilmiştir. Kız öğrenciler İzmir’de bulunan Kızılçullu Köy Enstitüsüne gönderilmişlerdir. 1951 senesinde ise Trabzon Beşikdüzü Köy Enstitüsü kız okulu yapılmıştır. 1951 senesinden itibaren Köy Enstitüleri 2 Kız ve 19 Erkek enstitüsü olarak eğitim-öğretim faaliyetlerine devam etmişlerdir. Enstitülerde karma eğitime son verildikten sonra okullara devam eden kız öğrenci sayısı ise ciddi ölçüde azalmıştır.

Demokrat Parti’nin 1950 senesinde iktidara gelmesi, Köy Enstitülerinin kaderini belirlemiştir. Nitekim Demokrat Parti Hükümeti 1953 senesinde Köy Enstitülerini İlköğretmen Okulları ile birleştirmiş ve Köy Enstitülerini işlemez bir hale getirmiştir. (Öztürk 2012, s. 22) Köy Enstitüleri, 27 Ocak 1954’te kabul edilen 6234 sayılı yasa ile de resmen kapatılmıştır. Söz konusu kanunda Enstitülerin durumu ile ilgili olarak şu hususlara yer verilmiştir; *“Köy Enstitüleri ile ilköğretmen okulları ‘İlköğretmen okulları’ adı altında birleştirilmiştir” denilmiştir. Kanunda Enstitü öğretmenlerinin durumu için ise; “Halen köy enstitülerinde çalışanlardan Milli Eğitim Vekaletince tesbit ve kabul edilen öğretmen okulları, ziraat okulları, sanat okulları ve enstitüleri mezunu öğretmenlerin öğretmen okullarında istihdamına devam olunur.”* (Resmi Gazete, 4 Şubat 1954, s. 8093 vd.)

5.Sonuç

Atatürk’ün takip ettiği eğitim politikalarının temel amacı, Türk milletinin çağdaş medeniyetler seviyesine ulaşmasıdır. Bu maksatla yapılan düzenlemeler, şehirlerde olduğu gibi kırsal kesimde de okullaşmanın artmasını sağlamıştır. Erken cumhuriyet döneminde bir tarım ülkesi olan Türkiye’nin gelişmesi için, kırsal kesimde bir eğitim öğretim seferberliği başlatılmıştır. Köy Eğitim Kursu ile başlayan bu süreç, Köy Enstitülerinin kuruluşu ile en verimli dönemine ulaşmıştır.

Türkiye’de toprak ile ilgili yapılan tüm düzenlemelerin başta toprak sahiplerini rahatsız ettiği bir gerçektir. Nitekim Köy Enstitüleri’nin kuruluşu bu çevreleri rahatsız eden bir gelişme olmuştur. Enstitülerin kurucu kadrosunda yer alan isimlerin kamuoyunda sol/sosyalist eğilimlere sahip kişiler olarak tanınıyor olmaları, Köy Enstitülerinden rahatsız olan çevrelerin konuya komünizmle mücadele çerçevesinde yaklaşmalarını kolaylaştırmıştır. Üstelik bu durum CHP içindeki muhafazakâr isimler ile Demokrat Partililerin üzerinde anlaşmaya varabildikleri ender konulardan biri olmuştur.

Köy Enstitüleri, Türkiye’nin köy, köylülük ve memleket kalkınması konularında gerçekleştirdiği önemli atılımlardan biridir. Köy Enstitülerini kuracak kadar ileri görüşlü olan siyasi kadrolar bu kurumları yaşatacak demokratik olgunluğa sahip olmadıkları için, Köy Enstitüsü deneyimi başarısız olmuştur. Kamuoyunda etkili olan sağ ve sol ideolojilerin taraftarları arasındaki kavgalar, Türkiye’nin Köy davası için de hayati bir kıymete sahip olan bir kurumun kapatılmasına sebep olmuştur.



6. Kaynakça

6.1. Resmi Yayınlar

C.H.P. Programı (1935), Ulus Basımevi, Ankara 1935

Köy Eğitim Kurşları ile Köy Öğretmen Okullarının İdaresine Dair Kanun (1939). ResmiGazete., Sayı:4258, Kanun No: 3704, 14 Temmuz.

Köy Eğitimleri Kanunu (1937). Resmi Gazete. Sayı: 3639 Kanun No:3238, 24 Haziran.

Köy Enstitüleri ile İlköğretmen Okullarının Birleştirilmesi Hakkında Kanun (1954).Resmi Gazete. Sayı: 8625, Kanun No: 6234, 4 Şubat.

Köy Enstitüleri Kanunu (1940). Resmi Gazete. Sayı:4491, 22 Nisan.

TBMM Tutanak Dergisi.(1945). Cilt: 17. Devre: VII. Toplantı: 2. 60. Birleşim. 23 Mayıs.

6.2. Telif/Tetkik Eserler

Albayrak, Mustafa (1994). Millet Mekteplerinin Yapısı ve Çalışması. Atatürk Araştırma Merkezi Dergisi. Cilt: 10 Sayı: 29, s.s. 471-482.

Ali, Sabahattin (2006). Marko Paşa Yazıları ve Ötekiler. Yapı Kredi Yayınları. İstanbul

Altunay, Niyazi (2005). Toplu Köy Enstitüsü Sistemine Bir Bakış. Kelebek Matbaası.

Anık, Mehmet (2006). Bir Modernleştirme Projesi Olarak Köy Enstitüleri. Divan İlmiAraştırmalar Dergisi. Sayı:1 s.s. 279-309.

Aydın, Mesut. Aydın, Mehmet Korkud (2016). Türk İnkılabı Tarihi. Azim Matbaacılık. Ankara.

Aysal, Necdet (2005). Anadolu'da Aydınlanma Hareketinin Doğuşu: Köy Enstitüleri. Ankara Üniversitesi Türk İnkılâp Tarihi Enstitüsü Atatürk Yolu Dergisi. Sayı: 35-36.

Dündar, Can (2003). Köy Enstitüleri. İmge Yayınevi. Ankara.

Öztürk, Emine (2012). Cumhuriyet Dönemi Aydın Kimliği Sekülerleşme ve KöyEnstitüleri, Rağbet Yayınları, İstanbul.

Tekben, Şerif (1962). Neden Köy Enstitüleri, Türkiye Milli Gençlik Teşkilatı Yayınları, İstanbul.

Üstün, Süleyman (1963). Köy Enstitüleri. Türk Solu. Yıl:1 Sayı:1, 16 Nisan.

Varlı, Arzu (2012). Devletçilik Politikalarının Tarım Kesimi Üzerindeki Etkileri (1930-1940). Öneri. Cilt: 10, Sayı: 38. s.s. 113-124.



RECOGNIZING FLOW EVALUATION ON SURFACE OF NACA0015 AIRFOIL AT VARIOUS ANGLES OF ATTACK

Mustafa ÖZDEN

Halil Hakan AÇIKEL

Mustafa Serdar GENÇ

Kemal KOCA

Wind Engineering and Aerodynamics Research Laboratory, Department of Energy

Systems Engineering, Erciyes University, 38039, Kayseri, Turkiye

Energy Conversions Research and Application Center, Erciyes University, 38039, Kayseri, Turkiye

Abstract

Airfoils are the special components for the flight vehicles including aircraft, wind turbine blades. Unmanned aerial vehicles, micro air vehicles, etc. Airfoils have different pressure zone because of presence of their lower and upper surfaces, leading the lift force to occur. Wind turbines can create a rotational movement with the lift force, whilst aircraft can fly. Airfoils may contain many sorts and one of them is symmetrical airfoil which does not produce any lift force at $AoA=0^\circ$. However, it can have more benefit when angle of attack changed. In this study, flow formed on NACA0015 airfoil was investigated with numerical attempts and the results were compared with the experimental data in the literature. In terms of better investigating the flow phenomena such as laminar separation bubble or boundary layer separation on suction surface of NACA0015 airfoil, the velocity contours were examined at different angles of attack.

1 Introduction

The study of the aerodynamic effects of wings dates back to the 1920s. At that time, studies were carried out to increase the lift coefficient and reduce the drag force. Nowadays, with the development of technology, there have been different developments in the experimental field, and at the same time, convergence occurs in both experimental and numerical analyzes with many algorithmic developments in the numerical field. Xu et al. [1] they examined the differences in lift (C_L) and drag coefficients (C_D) at different mesh numbers. They made pressure measurements at certain positions (x/c) on the wing and compared them with the experimental results and found the difference between them less than 5%. Yu et al. [2] investigated the lift and drag coefficients on different mesh models and numbers on airfoil. They simulated the effects of ventilation rate on cavity shape and pressure distribution using the LES method. Kravtsova et al. [3] investigated C_L and C_D values in IFEM solver at different angles of attack. Itsariyapinyo et al. [4] Reynolds number of 1.1×10^5 also examined the C_L , C_D and C_p values of the 0° , 6° and 12° NACA0015 airfoil. Luo et al. [5] measured C_L, C_D values at 12 m/s at Reynolds number of 1.872×10^5 at two negative and two positive angles of attack. Siddiqui et al. [6] 2D and 3D analyzes were performed on different turbulence models and their lift and drag coefficients were examined as seen in Table 1. Gioria et al. [7] simulated the various flow types formed on the airfoil by conducting different turbulence models at different Reynolds number.

Table 1. C_L and C_D values in different turbulence models [6]

Turbulence model/Experiments	$\alpha = 13^\circ$		$\alpha = 17^\circ$	
	C_f	C_d	C_f	C_d
Experiment (Piziali,1993)	1.15	0.0331	0.807	0.091
$k - \omega$ SST model	1.125	0.034	0.911	0.110
$k - \varepsilon$ model	1.025	0.094	0.832	0.165
SA model	0.990	0.129	1.052	0.219

2 Numerical Model

Related to the flow domain of NACA0015 airfoil, it was sketched as illustrated in Figure 1. The left of domain was named as velocity inlet, whereas right side of domain was defined as pressure outlet. Bottom and upper surfaces of the domain were identified as wall. The velocity inlet and wall surfaces were structured $10c$ away from the leading edge, suction and pressure surfaces, respectively. However, pressure outlet was structured $20c$ away in order to observe vortices form at the wake region.

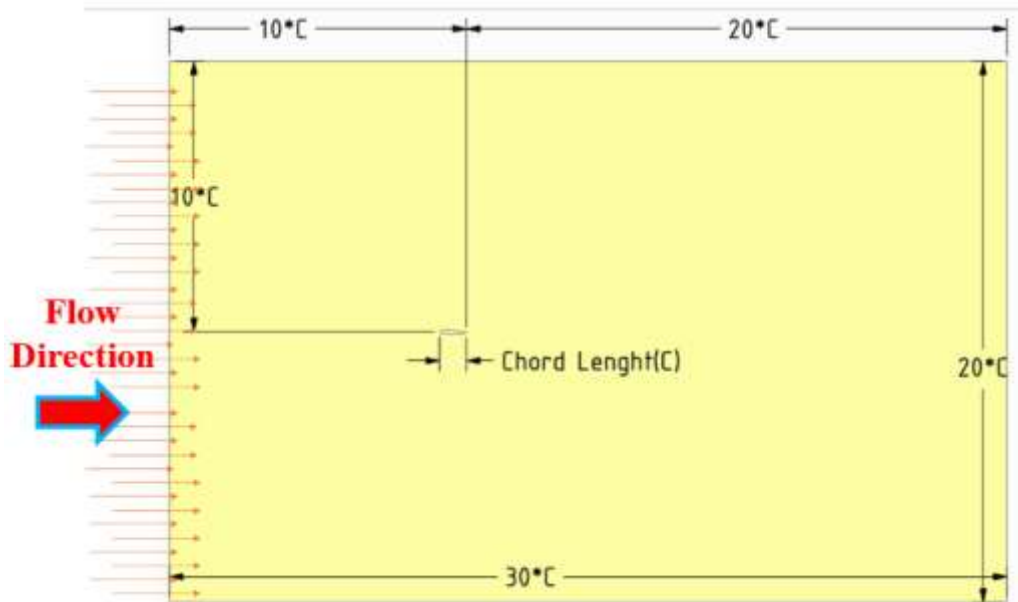

Figure 1. The sketch of the flow domain

Apart from flow domain, the mesh structure was formed as shown in Figure 2. C-type mesh was fulfilled in this study. Ansys Fluent software was used for the analysis. Turbulence model was determined as Transition SST.

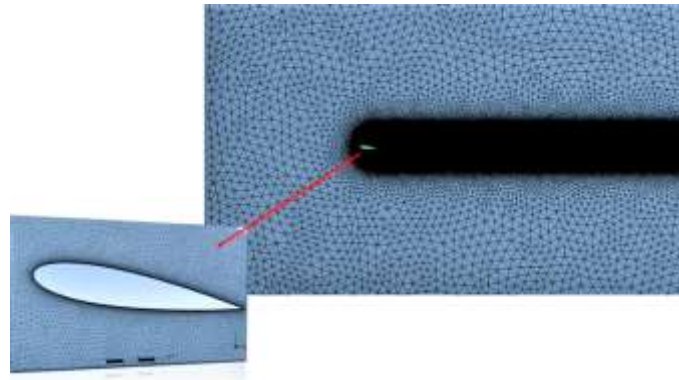

Figure 2. The mesh structure on NACA0015 airfoil

3 Numerical results and experimental dataset

In this section, the results of numerical simulation were obtained and discussed. Moreover, these results were compared with the experimental results.

3.1 Numerical results

Related to the numerical results, the instantaneous velocity contours were shown in Figure 3. It was clearly pointed out that the formation of laminar separation bubble (LSB) existed at the trailing edge part of airfoil at lower angles of attack. As expected, the LSB moved towards to leading edge of airfoil when increasing angle of attack with interval of 2 deg. In particular, LSB burst at $AoA=10^\circ$, resulting in presence of trailing edge flow separation. Furthermore, this flow separation caused the stall phenomenon to form on the airfoil. At higher angles of attack, this trailing edge separation turned into the leading-edge separation and massive flow separation occurred on the suction surface.

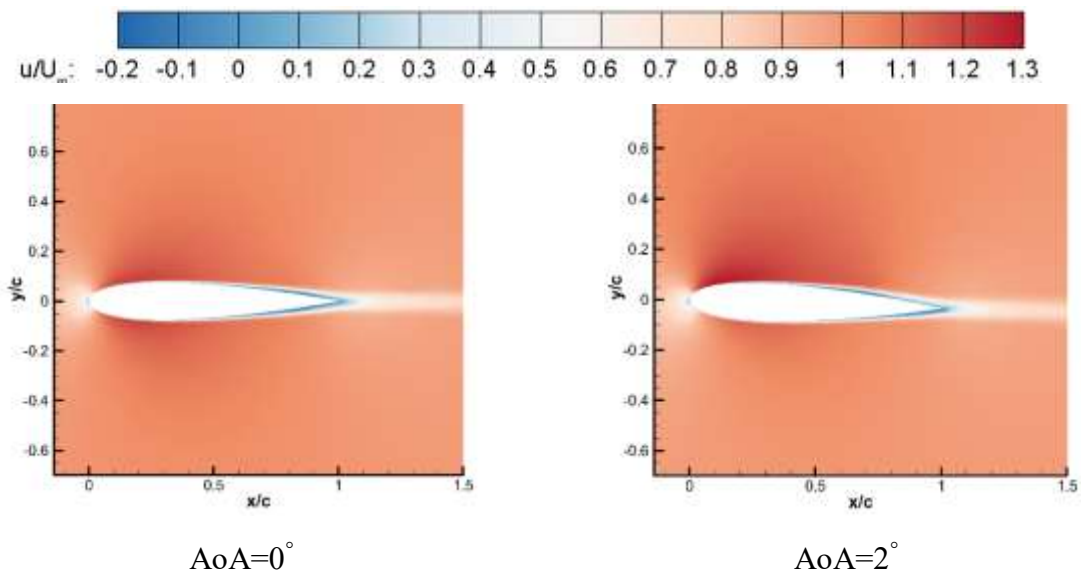



INTERNATIONAL ASIAN CONGRESS ON CONTEMPORARY SCIENCES – VII

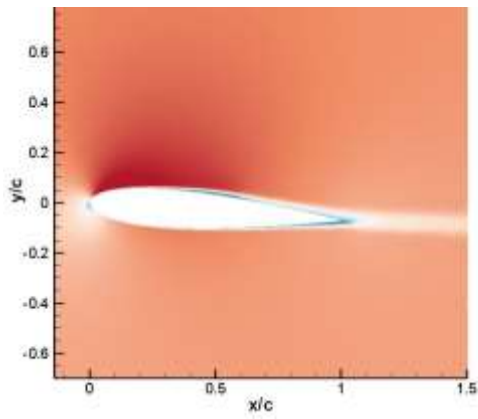

AoA=4°

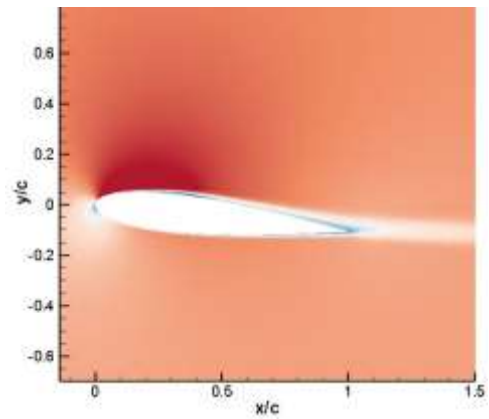

AoA=6°

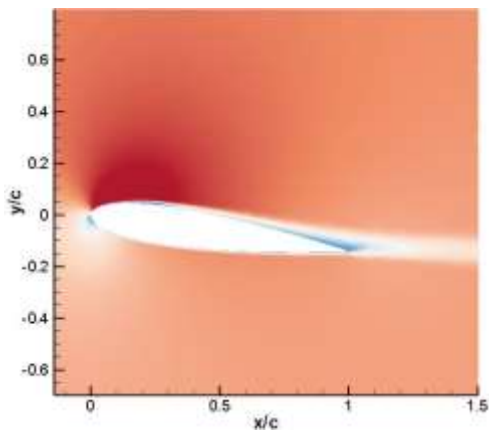

AoA=8°

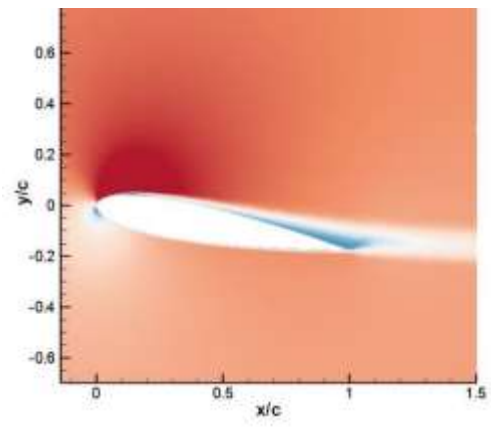

AoA=10°

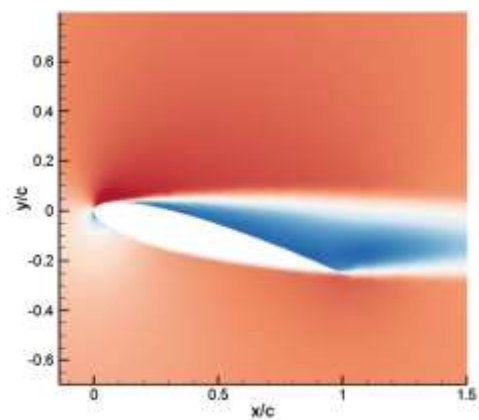
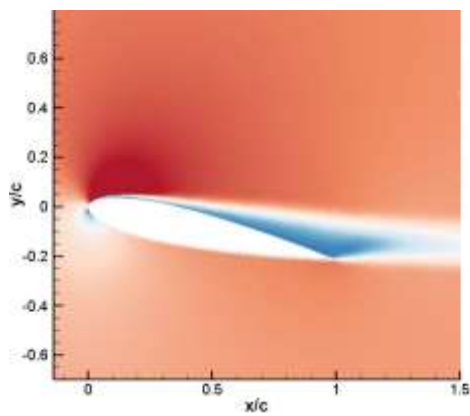
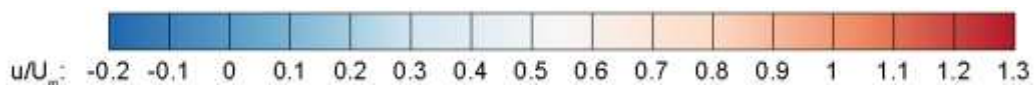

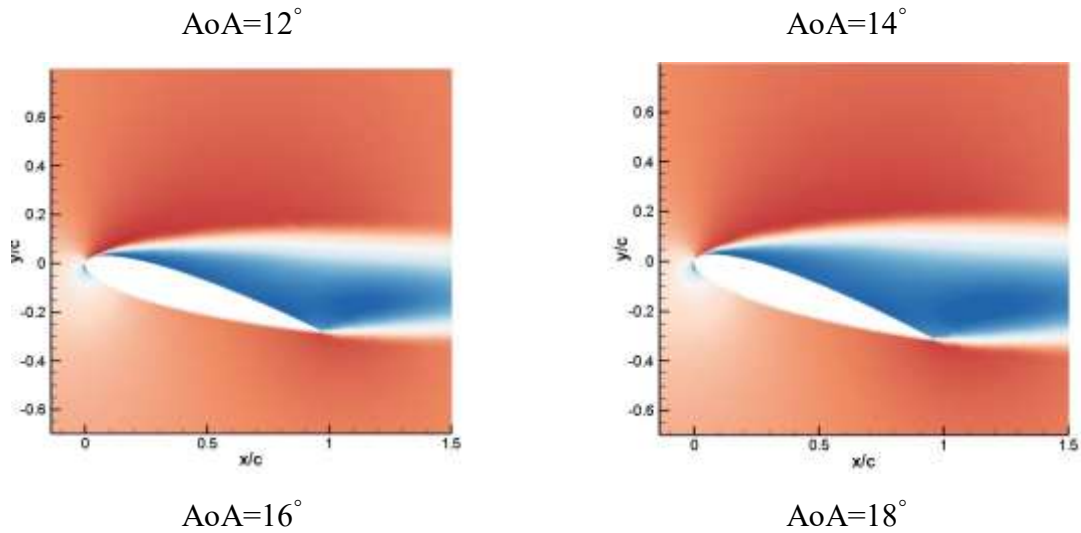

Figure 3. The instantaneous velocity contours of NACA0015 airfoil

3.2. Experimental and numerical aerodynamics coefficients

In Figure 4, the results of aerodynamic force coefficient were provided as a result of numerical simulation and these results were also compared with the findings of Ref. [8]. Numerical results clearly indicated that the value of C_L was 0.8. After a while, the flow could not reattach to suction surface and boundary layer flow separation existed at $AoA= 10^\circ$, resulting in presence of abrupt stall at the lift curve. Similarly, it was observed that there was a sudden increment at the C_D curve when stall occurred. Additionally, the numerical results clearly exhibited well agreement with the experimental results.

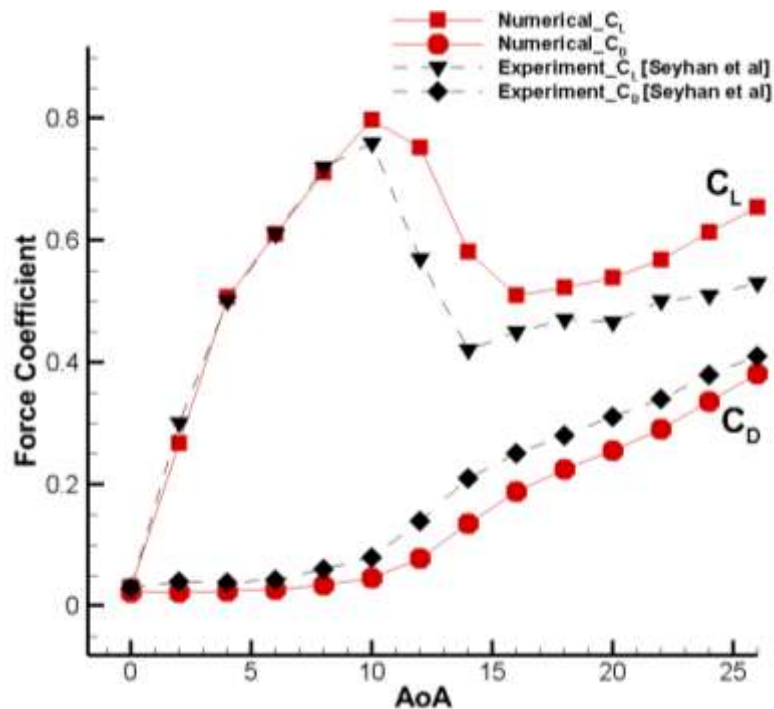

Figure 4. The aerodynamic force coefficients of NACA0015 airfoil



3.3. Pressure coefficient on NACA0015 airfoil

In terms of better understanding of flow phenomena formed on suction surface of NACA0015 airfoil, the graphs of pressure coefficients ($-C_p$) were denoted in Figure 5. At $AoA=10^\circ$, the flow separation and reattachment respectively occurred at $x/c=0.05$ and $x/c=0.15$ region in which the LSB formed. On the other hand, it was observed that LSB burst and leading-edge flow separation occurred when angle of attack increased to 14 deg.

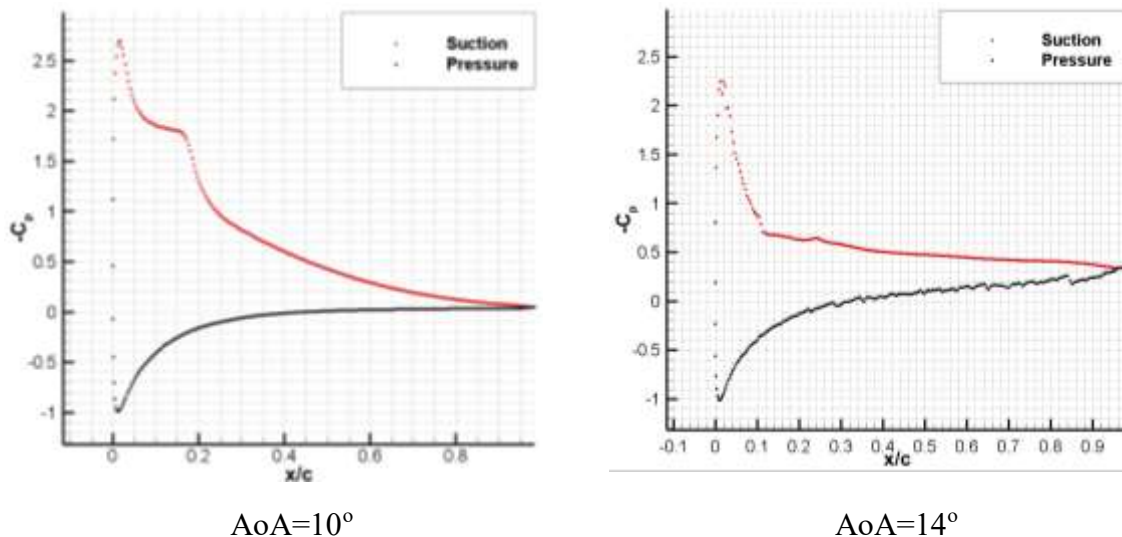

Figure 5. Pressure coefficient graphs of NACA0015 airfoil

Conclusion

In this study, numerical simulation attempted to investigate flow phenomena formed on suction surface of NACA0015 airfoil at Reynolds number of 0.63×10^4 and various angles of attack. Additionally, numerical results were compared with the experimental findings in the literature. The numerical results indicated that LSB formed on the suction surface at the lower angles of attack. Then, it burst when angles of attack increased, resulting in existing of stall at $AoA=10^\circ$. Stall phenomenon caused the lift curve to decrease abruptly. In contrast to lift curve, a sudden increment formed at the drag curve when stall occurred.

References

- 1- Xu, B., Liu, K., Deng, Y., Shen, X., Wang, H., Zhang, D., & Jiao, Y. (2022). The characteristics of unsteady cavitation around a NACA0015 hydrofoil with emphasis on the thermodynamic effect. *Ocean Engineering*, 264, 112418.
- 2- Yu, A., Qian, Z., Tang, Q., & Liu, J. (2022). Numerical investigation of pulsating energy evolution in ventilated cavitation around the NACA0015 hydrofoil. *Ocean Engineering*, 257, 111685.
- 3- Kravtsova, A. Y., Markovich, D. M., Pervunin, K. S., Timoshevskiy, M. V., & Hanjalić, K. (2014). High-speed visualization and PIV measurements of cavitating flows around a semi-



INTERNATIONAL ASIAN CONGRESS ON CONTEMPORARY SCIENCES – VII

- circular leading-edge flat plate and NACA0015 hydrofoil. *International Journal of Multiphase Flow*, 60, 119-134.
- 4- Itsariyapinyo, P., & Sharma, R. N. (2018). Large Eddy simulation of a NACA0015 circulation control airfoil using synthetic jets. *Aerospace Science and Technology*, 82, 545-556.
 - 5- Luo, S. C., & Chen, Y. S. (2012). Ground effect on flow past a wing with a NACA0015 cross-section. *Experimental Thermal and Fluid Science*, 40, 18-28.
 - 6- Siddiqui, M. S., Rasheed, A., & Kvamsdal, T. (2020). Numerical assessment of RANS turbulence models for the development of data driven Reduced Order Models. *Ocean Engineering*, 196, 106799.
 - 7- Gioria, R. S., He, W., & Theofilis, V. (2015). On global linear instability mechanisms of flow around airfoils at low Reynolds number and high angle of attack. *Procedia IUTAM*, 14, 88-95.
 - 8- Seyhan, M., Sarioglu, M., & Akansu, Y. E. (2021). Influence of Leading-Edge Tubercle with Amplitude Modulation on NACA 0015 Airfoil. *AIAA Journal*, 59(10), 3965-3978.



FLEXIBLE METAMATERIAL-BASED ELECTROMAGNETIC ENERGY HARVESTING FOR WLAN FREQUENCY BAND

Olcay ALTINTAŞ

Erkan TETİK

Department of Avionics, Faculty of Aeronautics and Astronautics, Iskenderun Technical University, Iskenderun, Hatay, Türkiye

Department of Mathematics and Science Education Department of Science Education, Faculty of Education, Usak University, Uşak, Türkiye

Abstract

Wireless Local Area Network is a very important technology developed to operate in the unlicensed industrial, scientific, and medical bands around 2.4 and 5 GHz. It has also attracted much attention thanks to the wide applications created by the development of electronic textile technologies worn on the body. Wearable devices have an important place in electronic textile research and one of the most important requirements for these devices is battery supply. Metamaterial structures, which have specific characteristics such as negative refractive index, are also used in electronic textile research, as in many others. Recent studies show that energy can be collected at certain frequencies with metamaterial-based structures and this energy can be used in electronic textile-based devices by making AC conversion. The proposed structure in this study presents an MTM-based energy harvesting application using flexible materials. For the proposed MTM design, the S parameters, absorption characteristics and energy harvesting studies are investigated in the frequency range of 4-6 GHz. The power and loss characteristics are analyzed by integrating lumped element into the gaps of the MTM structure. It has been observed that the results obtained for the 5 GHz frequency value provides the requirements for electromagnetic energy harvesting. Accordingly, the proposed MTM structure can be considered as a for use in wearable electronic textile applications that can be integrated into clothing.

Keywords: Flexible metamaterial; energy harvesting; electronic textile; electromagnetic

INTRODUCTION

Wireless Local Area Network (WLAN) technology is known as a highly advanced standard that can operate on 2.4 and 5GHz frequencies. With the advancement of technology, the wireless communication has become an important part of our daily lives. People started to carry their wireless devices with them all the time. These developments have made it mandatory for wireless devices to be more flexible. Flexibility of conductive and non-conductive materials has become an important issue in wireless device design. Alternatives for structures produced using copper and dielectric materials, developed using flexible materials, have begun to emerge. Metamaterial (MTM) structures, which have extraordinary electromagnetic (EM) properties such as negative permittivity (ϵ) and permeability (μ), can be considered as one of these alternatives. MTMs with negative refractive index were first proposed theoretically by Veselago in 1968 (Veselago, 1968). MTM structures, which were shown experimentally in the 2000s (Pendry, 1996, 2000; Shelby et al., 2001), attracted a lot of attention by researchers. Changing their EM characteristics using their geometric parameters was remarkable interesting. Numerous MTM types have been developed with periodic arrays in different geometries. With these developments, MTMs have started to be

recommended for many application areas such as perfect absorbers (Akgol et al., 2017; Dincer et al., 2016; Tirkey and Gupta, 2019), harvesting (Almoneef and Ramahi, 2014; Bağmancı et al., 2018; Parikesit et al., 2012), flexible antennas (Soh et al., 2011; Tetik and D. Tetik, 2018; Tetik and Tetik, 2017), and sensors (Tetik, 2020; Tetik and Erdiven, 2018; Yang et al., 2013). In recent years, MTM designs developed for energy harvesting in the 2.4 and 5 GHz frequency ranges are also quite remarkable (Bakır et al., 2018; Chen et al., 2014; Erkmen et al., 2018; Ramahi et al., 2012). The production of these structures using flexible materials and their use in energy harvesting applications occupy an important place in wireless communication. Nowadays, many flexible MTM designs are proposed for different frequency values.

In this study, a flexible perfect MTM absorber design using wearable materials is proposed for energy harvesting applications. Electronic textile (e-textile) materials have preferred in the design of the proposed structure. First, the optimization of the structure has performed based on the geometrical parameters. The S parameters of the structure obtained as a result of the optimization have calculated. After obtaining the peak in the targeted frequency range, the absorption, reflection, and transmission performance of the proposed structure have analyzed. In the last phase, the lumped element is integrated into the gap regions created in the structure. According to the results obtained, the energy collection performance of the building has examined.

MATERIALS AND METHODS

Dimensions of the flexible perfect MTM absorber structure as the no-lumped element, as depicted in Fig. 1, are designed by using the e-textile materials. The design dimensions shown in Fig. 1(b) are proportionally enlarged for clarity. Metamaterials consist of periodically arranged unit cells. The unit cell of the designed MTM structure consists of 3 parts, the copper plane, resonator, and dielectric substrate, respectively. The conductive and insulating e-textile materials have used for the design of these 3 parts. For the conductive and insulating structures, the pure copper polyester taffeta fabric (PCPTF) and felt textile materials have preferred, respectively. When defining the PCPTF e-textile material, 3 important properties are used, these are parameters electrical conductivity, measured and surface resistance, which have values of $2.5 \times 10^5 \text{ Sm}^{-1}$, $0.031 \text{ Ohm sq}^{-1}$, and 0.05 Ohm sq^{-1} . The 3 properties used when defining the dielectric layer are the loss tangent, permittivity and thickness values, and these parameters take the values of 0.016, 1.22, and 2 mm, respectively.

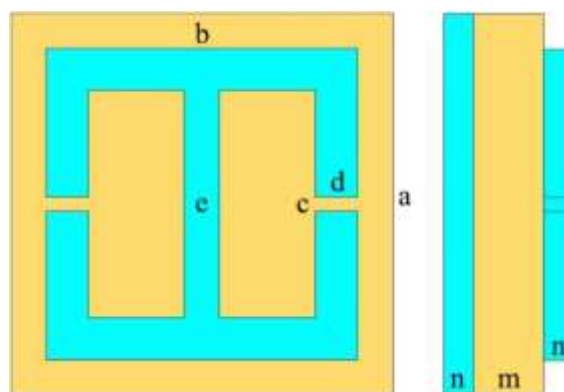

Figure 1. The flexible perfect MTM absorber structure. Dimensions of (a) the front view and (b) left view.

Parts ground plane and dielectric substrate of the proposed MTM structure have a dimension of $d=10.85 \text{ mm}$. The resonator and copper plane have a thickness of $n=0.035 \text{ mm}$. In addition, the proposed MTM structure has the dimensions of $b=8.85$, $c=0.4$, $d=1.2$, and $e=1$ parameter. The



thickness of the dielectric substrate is $m=3$ mm. Optimization and calculation steps have performed using the EM solver CST Microwave Studio (Computer Simulation Technology GmbH, Darmstadt, Germany) based on the finite integration technique (FIT).

CALCULATION METHOD

After the parametric optimization was completed for the proposed structure, the S parameters have obtained. All calculations are carried out at 4–6 GHz frequency range. The results of the S parameters are given in Fig. 2. The S_{11} parameter peaked at a frequency of 5 GHz band and the amplitude of this peak indicates that the proposed structure has sufficient potential for perfect absorption. This frequency value is a frequency at which EM energy can be transferred from one point to another in waves at a high level. The proposed structure has two gap regions where resistors will be placed to collect EM energy.

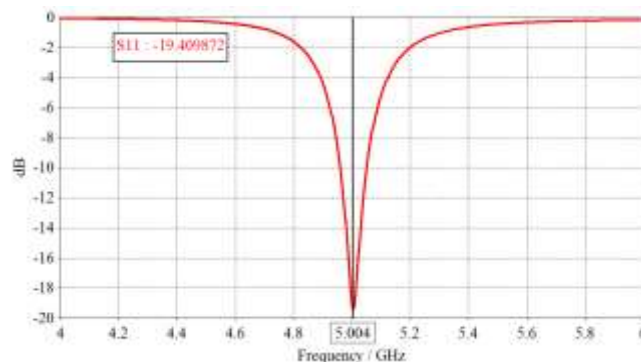

Figure 2. S_{11} parameter of the flexible perfect MTM absorber structure.

After obtaining the appropriate peak as a result of the calculation of the S parameters, the simulation procedure of the proposed MTM structure for the absorption, reflection and transmission parameters has carried out. The results obtained are graphically shown in Fig. 3. According to these results, we see that the transmission value is zero in the entire frequency range. It is seen that the reflection value is zero at the 5GHz frequency value determined for the WLAN band, while reflection occurs for the other frequency values. This shows that we can obtain zero reflection parameter for the desired 5GHz frequency value. If the reflectance value approaches zero, it means that the absorption value is maximum. It is understood from the graph that the absorption parameter peaks close to the maximum at a rate of 98.85 percent.

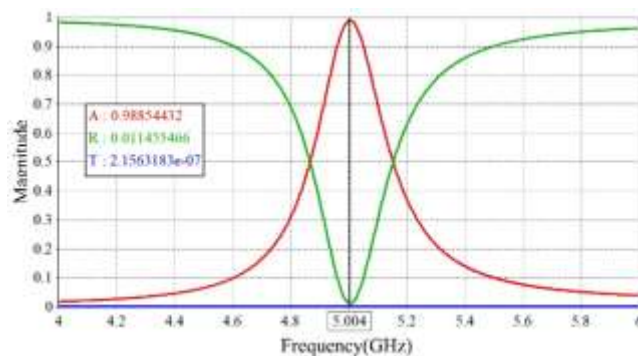

Figure 3. The absorption, reflection, and transmission results of the flexible perfect MTM absorber structure.

Absorption results have obtained using the equation $A(\omega) = 1 - R(\omega) - T(\omega)$. In the equation, reflection and transmission parameters are expressed as $R(\omega) = |S_{11}|^2$ and $T(\omega) = |S_{21}|^2$, respectively. If this equation is applied at the resonance frequency, the equation becomes $A(\omega) = 1 - R(\omega)$ since the conduction value is zero. Accordingly, the absorption graph can be obtained



by using the S_{11} parameter. The obtained absorption value shows that the proposed structure has perfect absorption. It can be used in many applications such as energy harvesting, which has excellent perfect characteristic.

HARVESTING APPLICATION

At this stage, the energy storage capacity of the proposed flexible perfect MTM structure was analyzed. The proposed structure has 2 gap regions at the edges and the lumped element is integrated into these two regions. The CST Microwave Studio program has different types as lumped elements. In this study, the resistor was chosen as the lumped element type. Optimization has performed to determine which resistor value the energy collected on the resonator had the highest efficiency. From this perspective, the resistance value changes range 2000 and 10000 Ω in 2000 Ω increments. Absorption of MTM structure results have obtained for each resistor value. The results obtained as a result of energy optimization are shown in Fig. 4.

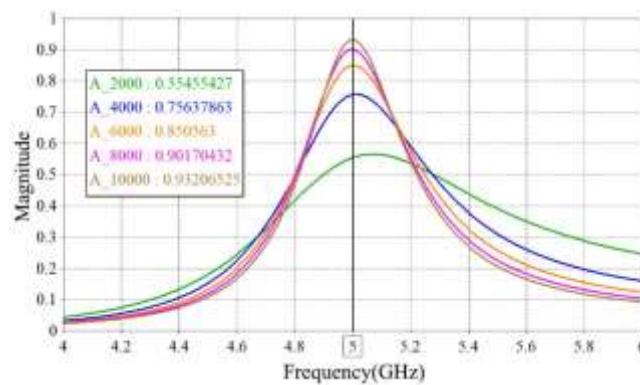

Figure 4. The harvesting optimization in range 2000 and 10000 Ω in 2000 Ω increments of the flexible MTM structure.

The optimization process has carried out in the 4-6 GHz frequency range. The same resistance values for the gap regions are used for both lumped elements. Lumped elements 2 have magnitude values 0.5545, 0.7563, 0.8505, 0.9017, and 0.9320 for 2000, 4000, 6000, 8000, and 10000 Ω , respectively. It is seen that as the resistance value increases, the absorption value also increases. This is due to the slowdown of the current flowing through the gaps formed as the resistance increases. When the proposed flexible MTM structure is integrated to the resistor, it is seen that absorption has increased from 93.2 % to 55 %. Obtained results show that this MTM also exhibits perfect absorption features and can be used in the perfect absorption based harvesting applications.

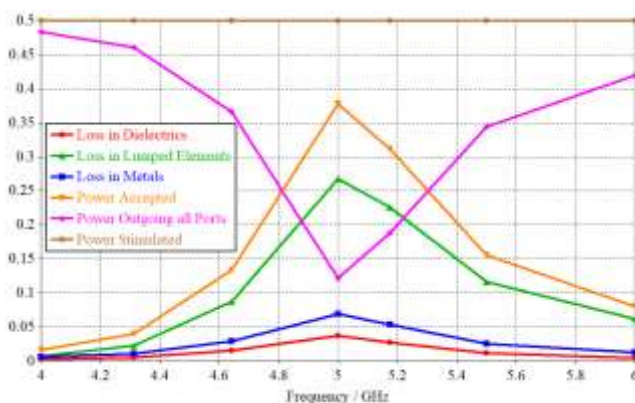

Figure 5. The power and loss characteristics of the proposed MTM structure.



The loss and power parameters have analyzed for the proposed structure to determine the most suitable resistance value. The loss in dielectrics, loss in lumped elements, loss in metals, power accepted, power outgoing all ports, and power stimulated parameters have analyzed in the 4-6 GHz frequency range. The results obtained are demonstrated in Fig. 5. It is seen that all parameters peak form at the 5GHz frequency value. The proposed flexible MTM structure has two floquet ports (Z_{\min} and Z_{\max}) that have been excited separately by the domain solver of CST microwave studio. By default, the power stimulated for each port is 0.5 W per frequency, giving a total of 1. In this regard, the power and loss graph has been prepared in the range of 0-0.5 Watts. Parameters the loss in dielectrics, loss in lumped elements, loss in metals represent the power consumed on the proposed MTM structure. The parameters Loss in Metals, Loss in Dielectrics, and Loss in Lumped Elements (Resistor) have the values of 0.0701, 0.039, and 0.2678 W, respectively. Power, defined as the harvesting energy, is expressed as the loss over the lumped element. The results show that the most power is concentrated on the resistor. According to the results of the simulation, the maximum power transfer to resistor occurs at 4000 ohms with 0.2678 W. EM energy, which is desired to be converted into energy, is collected in the resistor placed along the gap thanks to the surface current localization. The proposed MTM structure enables AC-DC energy conversion thanks to the easy resonator design and the power obtained. This structure can be integrated into the clothes and can be used as alternative for low energy requirements.

CONCLUSION

In this study, flexible perfect MTM absorber design using wearable materials is proposed for energy harvesting applications. The proposed MTM structure is designed to operate in the 5GHz WLAN frequency band. E-textile materials have preferred in the design of the proposed structure. Thus, the proposed structure offers the opportunity to be used on the human body. In the first stage, the optimization of the structure was carried out according to the geometric parameters. All optimization and calculation steps have performed in the 4-5GHz frequency range. With the optimization process, it is aimed that the proposed structure will both work in the 5GHz WLAN band and show MTM characteristics such as negative refractive index. After the optimization step is completed, the S parameters of the structure have calculated. It has been observed that the S_{11} parameter creates a peak at the 5GHz frequency. After obtaining the appropriate amplitude for the S_{11} parameter, the absorption, reflection, and transmission parameters have analyzed. The transmission value is zero at the 4-5GHz frequency range. The reflection parameter is equal to zero only at the 5GHz frequency value. The absorption value has reached the maximum level at the frequency of 5GHz. This value indicates that the structure is perfect MTM absorber. In the next step, the energy harvesting characteristics of the proposed MTM structure have investigated. In this regard, the loss and power parameters are calculated. It has been observed that the collected power on the resistors placed in the gap regions is 0.2678 W. These results show that the proposed flexible MTM absorber is suitable for energy harvesting applications for WLAN frequency band.

REFERENCES

- Akgol O, Altintas O, Dalkilinc EE, Unal E, Karaaslan M, Sabah C 2017. Metamaterial absorber-based multisensor applications using a meander-line resonator. *Optical Engineering*, 56: 087104.
- Almoneef T, Ramahi OM 2014. A 3-dimensional stacked metamaterial arrays for electromagnetic energy harvesting. *Progress In Electromagnetics Research*, 146: 109-115.
- Bağmancı M, Karaaslan M, Altıntaş O, Karadağ F, Tetik E, Bakır M 2018. Wideband metamaterial absorber based on CRRs with lumped elements for microwave energy harvesting. *Journal of*



- Microwave Power and Electromagnetic Energy, 52: 45-59.
- Bakır M, Karaaslan M, Altıntaş O, Bagmanç M, Akdoğan V, Temurtaş F 2018. Tunable energy harvesting on UHF bands especially for GSM frequencies. *International Journal of Microwave and Wireless Technologies*, 10: 67-76.
- Chen Z, Guo B, Yang Y, Cheng C 2014. Metamaterials-based enhanced energy harvesting: A review. *Physica B Condens Matter*, 438; 1-8.
- Dincer F, Karaaslan M, Colak S, Tetik E, Akgol O, Altıntaş O, Sabah C 2016. Multi-band polarization independent cylindrical metamaterial absorber and sensor application. *Modern Physics Letters B*, 30; 1650095.
- Erkmen F, Almoneef TS, Ramahi OM 2018. Scalable Electromagnetic Energy Harvesting Using Frequency-Selective Surfaces. *IEEE Trans Microw Theory Tech*, 66: 2433-2441.
- Parikesit GOF, Prasetia F, Pribadi GA, Simbolon DC, Pradhana GY, Prastowo AR, Gunawan A, Suryoprato K, Kusumaningtyas I 2012. Textile-based microfluidics: modulated wetting, mixing, sorting, and energy harvesting. *Journal of the Textile Institute*, 103: 1077-1087.
- Pendry J 1996. Extremely Low Frequency Plasmons in Metallic Microstructures. *Phys. Rev. Lett*, 76: 4773-6.
- Pendry JB 2000. Negative refraction makes a perfect lens. *Phys Rev Lett*, 85: 3966-3969.
- Ramahi OM, Almoneef TS, Alshareef M, Boybay MS 2012. Metamaterial particles for electromagnetic energy harvesting. *Appl Phys Lett*, 101: 173903.
- Shelby RA, Smith DR, Schultz S 2001. Experimental verification of a negative index of refraction. *Science*, 292: 77-86.
- Soh PJ, Vandenbosch GAE, Chen X, Kildal PS, Ooi SL, Aliakbarian H 2011. Wearable textile antennas' efficiency characterization using a reverberation chamber, in: *IEEE Antennas and Propagation Society, AP-S International Symposium (Digest)*. pp. 810–813.
- Tetik E 2020. Flexible perfect metamaterial absorber and sensor application at terahertz frequencies. *Journal of Optoelectronics and Advanced Materials*, 22: 213-218.
- Tetik E, Tetik G 2018. The effect of a metamaterial based wearable monopole antenna on the human body. *Celal Bayar University Journal of Science*, 14: 93-97.
- Tetik E, Erdiven U 2018. Functional Pressure and Density Sensor Design Based on Metamaterial Absorber. *Cukurova University Journal of the Faculty of Engineering and Architecture*, 33: 23-30.
- Tetik E, Tetik G 2017. The effect of a metamaterial-based wearable microstrip patch antenna on the human body. *Can J Phys*, 96: 796-800.
- Tirkey MM, Gupta N 2019. The quest for perfect electromagnetic absorber: A review. *Int J Microw Wirel Technol*, 11: 151-167.
- Veselago VG 1968. The Electrodynamics of Substances with Simultaneously Negative Values of ϵ and μ . *Soviet Physics Uspekhi*, 10: 509-514.
- Yang JJ, Huang M, Tang H, Zeng J, Dong L 2013. Metamaterial Sensors. *International Journal of Antennas and Propagation*, 2013: 1-16.



**ADDITION OF WAVY STRUCTURE TO FIXED NREL PHASE II WIND TURBINE
BLADE AND INVESTIGATION OF OPTIMIZATION PARAMETERS**

Tuna Murat BODUR

Osman BODUR

Mustafa Serdar GENÇ

Wind Engineering and Aerodynamics Research Laboratory, Department of Energy

Systems Engineering, Erciyes University, 38039, Kayseri, Turkiye

Energy Conversions Research and Application Center, Erciyes University, 38039, Kayseri, Turkiye

Abstract

The efficiency research which are related to increase or decrease have been done on NREL Phase II Turbine Blades which have applied to different humped that are variety amplitudes and wavelengths. In addition to the reference model, 30 different modified structures have been applied to the reference model. In the numerical studies, Cradle/SC-Flow software and k-kL-w turbulence transition model have been used for analysis and imaging. Moreover, the lift coefficient (C_L), and the drag coefficient (C_D), and related aerodynamic performance coefficients have been calculated. The number of Reynolds has been 300.097 in each of studies. It has been observed that the performance coefficients of the different models in the 30 modified models created have been higher than the reference blades, and they have been between 1.91-percent and a 21.75-percent. Statistical analysis has been performed based on numerical analysis results to see which parameter affects the system efficiency very/little while changing the blade design. To sum up, the wavelength is the most important parameter for the efficiency of the system, which is optimized, the placement/ positioning parameter is the second most parameter and the amplitude is the least effective parameter in system.

Keywords: Wind Turbine Blade, Humpback Whale Fin, CFD Analysis, Tubercules, NREL Phase II

Introduction

One of the most critical parameters affecting the efficiency of utilizing wind energy is the blade structure of the wind turbine. Improving the aerodynamic design of the blade structure directly affects the efficiency [1]. Aerodynamic performance is related to lift and drag and the ratios of these forces. Performance studies in aerodynamics have always focused on these issues due to high lift and low drag [2].

The Reynolds number is one of the most important phenomena in fluid mechanics. The Reynolds number is expressed as the ratio of viscous forces to inertial forces. Whether the flow is turbulent or laminar is a property dependent on the Reynolds number. In the airfoils, the Reynolds number is expressed by the equation depending on the chord length C , the freestream velocity U_∞ the density of the air ρ , and the dynamic viscosity of the air μ , as shown in equation 1.1 [3,4].

$$Re = \rho U_\infty C / \mu \quad (1.1)$$



The lift (C_L) and drag (C_D) coefficients on airfoils with a shape depend on the blade surface cross-sectional area ($A = C(\text{chord}) \times S(\text{span})$), the density of the fluid (ρ), the fluid velocity (V), and the lift (F_L) and drag (F_D) forces generated by the fluid on the profile [5]. In this direction, the C_L and C_D coefficients are as shown in equations (1.2) and (1.3).

$$C_L = \frac{F_L}{\frac{1}{2}\rho V^2 C} \tag{1.2}$$

$$C_D = \frac{F_d}{\frac{1}{2}\rho V^2 C} \tag{1.3}$$

In aerodynamic studies, development studies are carried out by considering the same principle for the propellers used in underwater and above-water vehicles and aircraft, as well as wind turbine blades. It is known that especially humpback whale blades reduce the friction forces underwater and increase the lift and moment effects [6].

Humpback whales are mammals with the largest and variable whalebone fins among whale species and the longest pectoral fins of all marine mammals [7]. Their aquatic hunting abilities are excellent and have protrusions of the pectoral fin front. Fin-shaped forelimbs move at shoulder height and show some flexibility throughout the blade span. Compared to other whales, the fin forelimbs have a high aspect ratio but show a slight curvature at the end of their forelimbs. The pectoral fin of the humpback whale has special leading protrusions. This unique structure improves the performance of the pectoral fin [8].



Fig. 1. Pectoral fin and protruding structure of humpback whale[9]

Experiments on wavy bodies has been shown periodic variations throughout the structure [9]. In Humpback whale blade applications in the wind tunnel, it was observed that when the tubercle models have been applied to the leading edge, it has been supplied to delay the stall angle and increase the total lift without increasing the friction force [10].

Tubercles are rounded projections that change the flow field around a lifting surface. The tubercle effect significantly aerodynamically affects the blades [11,12], wind turbine blades and tidal tube blades [13], marine vehicle propellers [14], and electronic heater absorber fans [15], etc.

Butt and Talha in their work have given fluctuations and variable wavelengths along the propeller blades, similar to the whale blade, and decoupled between the blades. In addition, they have conducted numerical studies of different variabilities on them as shown Fig. 2. They have stated that every variation in lifting and dragging rates causes an increase in efficiency [16].

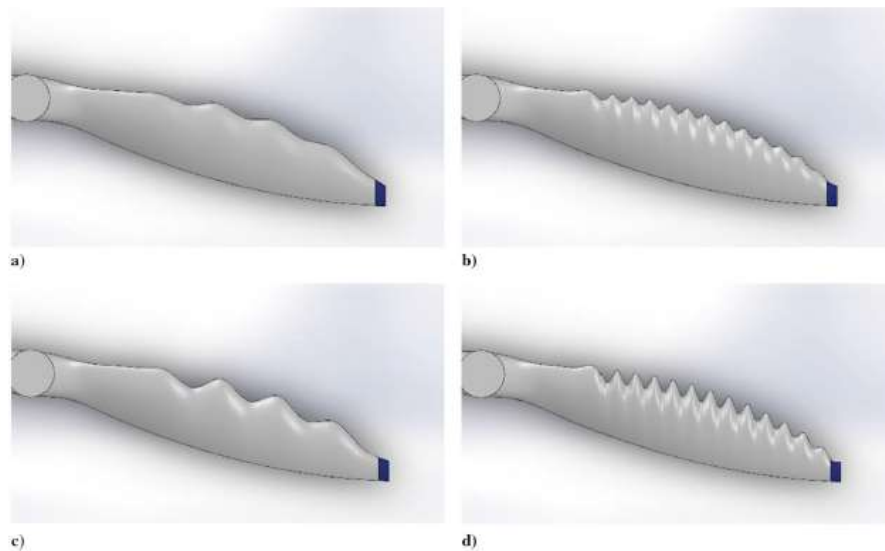

Fig. 2. Configuration representations a) C1 b) C2 c) C3 d) C4 [16]

Recently, Shi et al. [17] proposed applying cusps to the leading edge of turbine blades inspired by humpback whales to improve tidal turbine blade performance. It was also shown from experiments that such designs improved hydrodynamic performance in the low-end speed ratio (TSR) region without reducing the maximum power coefficient.

Johari et al. [18] changed the tubercle amplitude and wavelength values across the range of humpback whale flippers and compared six models with the base model. Overall, they noticed a different stopping behavior between the tubercle airfoils and the base model, with a delay in separation when tubercles were applied; also, leading-edge humps cause a reduction in lift coefficient when the angle of attack was below the baseline stopping angle. However, in the post-pause regimen, the cusps could improve the lift coefficient by up to 50% compared to the base model. By varying the amplitude and wavelength, Johari et al. also studied the effects of these geometric parameters on stopping, lifting, and dragging. In particular, blades with smaller amplitude performed best in terms of stall angle and maximum lift coefficient, and higher amplitude values resulted in smoother stall characteristics. The wavelength effects were considered less by the authors, although tubercles with smaller wavelengths achieved a higher maximum lift coefficient and lower drag with a stall angle.

In this study, the effect of different tubercle structures on the blade aerodynamics have investigated. The study has considered as numerical modeling and analysis. The reference blade model is the NREL Phase II blade belonging to the NREL blade family, with a rotor diameter of 5.023m, blade width of approximately 0.457m, and the angle of attack of 12° , with a flat structure (no torsional angle change in stations), generating about 20kW electricity.

Material and Methods

The model in our work is the NREL FAZ II blade. The lack of aerodynamic studies on this model has been the most important parameter in choosing this model. The availability of parametric data and experimental results in the NREL library have been another reason for selection.

The NREL Phase II blade model information that we have used in our studies has been taken from the NREL library. As shown in Table 1. and Fig. 2., our turbine blade model is S809.

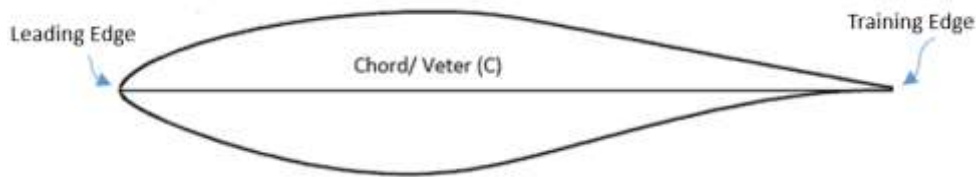

Fig. 3. S809 Blade Profile [19]

Table 1. NREL Phase II Blade Information [20]	
Blade Model	NREL Phase II
Blade Cross-section and planform	NREL Design (Constant Chord, no taper, no twist)
Root Extension	0.723 m
Blade Pitch Angle	12 degrees
Blade Profile	NREL S809
Blade Chord	0.4572 m
Wind Speed	6 m/s
Turbine Power	19.8 kW
Blade Twist	Untwisted

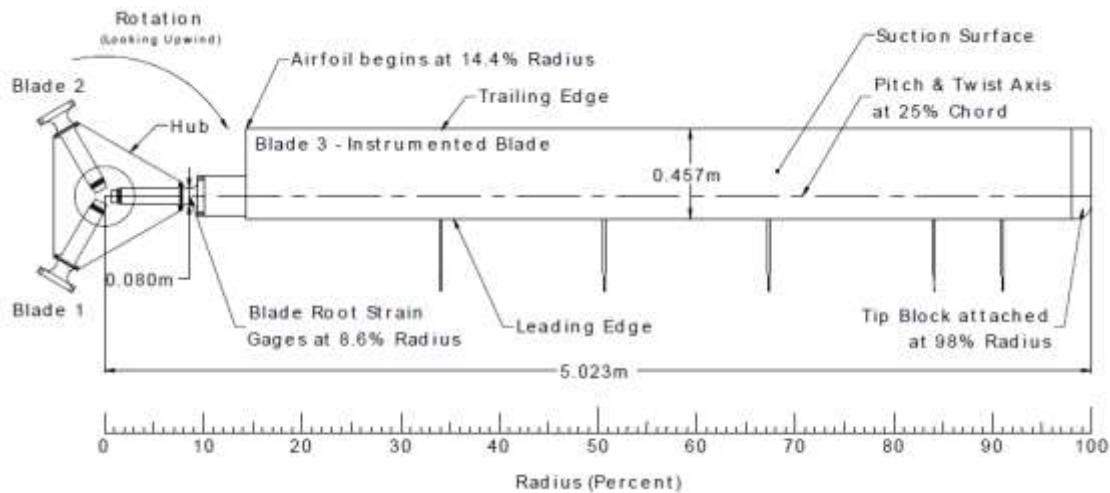

Fig. 4. Blade Information [21]

The necessary parameters for our work have been primarily determining the basic wind turbine blade. Then, the geometry parameters of the tubercle blades were determined. After choosing the basic model in line with the data from the NREL library, tubercle structures were created by following a sinusoidal path and using scaling at the leading and splitting edges.



Fig.5 Blade topology with tubercle structure

Table 2. New Versions Parameters	
Waves	S/5, S/10, S/20
Amplitudes (at Chord)	Cx0.8, Cx0.9
Location of Blade Surface (at Span)	Sx0.6, Sx0.7, Sx0.8, Sx0.9, Sx1
S= Span, C= Chord	

Firstly, the original model has been created (Fig. 5), and the other new designs have been created with parameters which are in Table 2., thus a 30-design have been modified. Afterwards, in this study the rate of efficiency which was related to forces (Fig. 6.) of model of all models was observed.

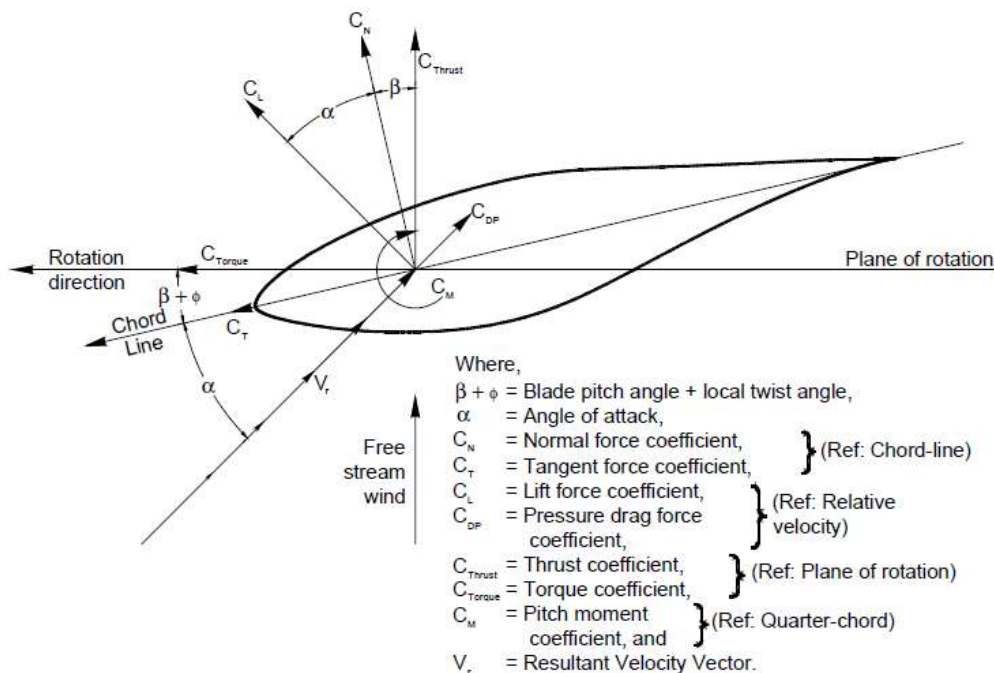

Fig. 6. Positioning of the wing model within the system and aerodynamic load rotation parameters [22]

Mesh Generation and Methodology of the Simulation

MSC Cradle program has been used throughout the analysis and simulation. The commercial code, MSC Cradle-SC/Flow has been employed in this 3-D numerical simulation. It solves Equations of (1) and (2) which represent conservation of mass and conservation of momentum Equations, and the convenient transport equation is given by Equation (3).

During the numerical analysis, Cradle- Sc-Flow software and the LKE k-kL-w turbulence transition model included in the software has been used. After the numerical analysis, Taguchi and Anova analyses have been performed to see the parameter variability in the statistical analysis performed. Incompressible simulation of steady-state is been performed throughout the analysis;

$$\frac{\partial u_i}{\partial x_i} = 0 \tag{2.1}$$

$$\frac{\partial \rho u_i}{\partial t} + \frac{\partial u_j \rho u_i}{\partial x_j} = \frac{\partial \sigma_{ij}}{\partial x_j} + \rho g_i \tag{2.2}$$

$$\frac{\partial}{\partial t} \rho \omega + \frac{\partial}{\partial x_j} u_j \rho \omega = \frac{\partial}{\partial x_j} \left[\left(\mu + \frac{\mu_t}{\sigma_\omega} \right) \frac{\partial \omega}{\partial x_j} \right] + \frac{\gamma \rho}{\mu_t} G_s - \beta \rho \omega^2 \tag{2.3}$$

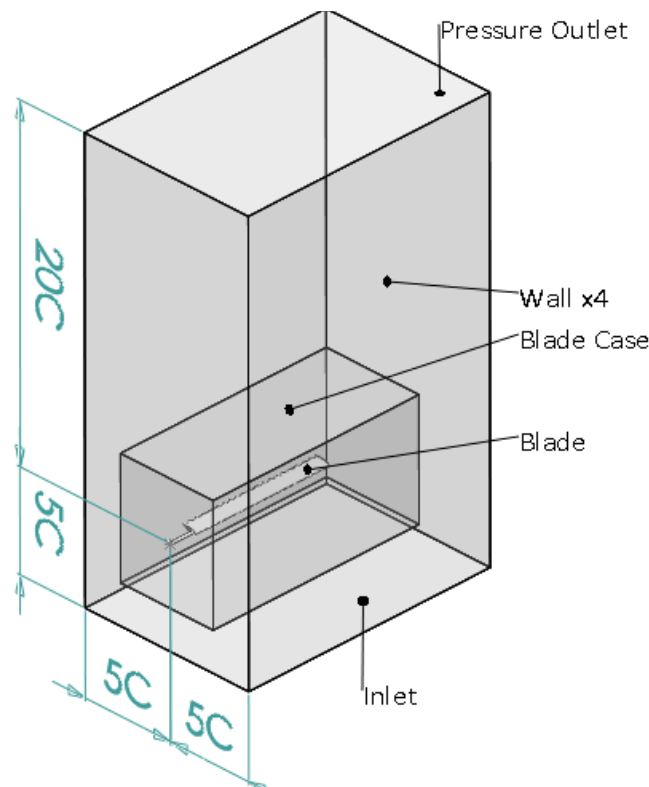

Fig. 7. Flow Area Volume For Fixed Blades

Genç M.S. et al. in their study conducted in 2011, they stated the required measurements of the flow volume. According to the study, there should be 10C from the attack edge to the surface (inlet) where the fluid enters, 20C from the blade attack edge to the fluid outlet surface (pressure outlet), and 10C from the blade edge to the upper and lower wall areas [23].

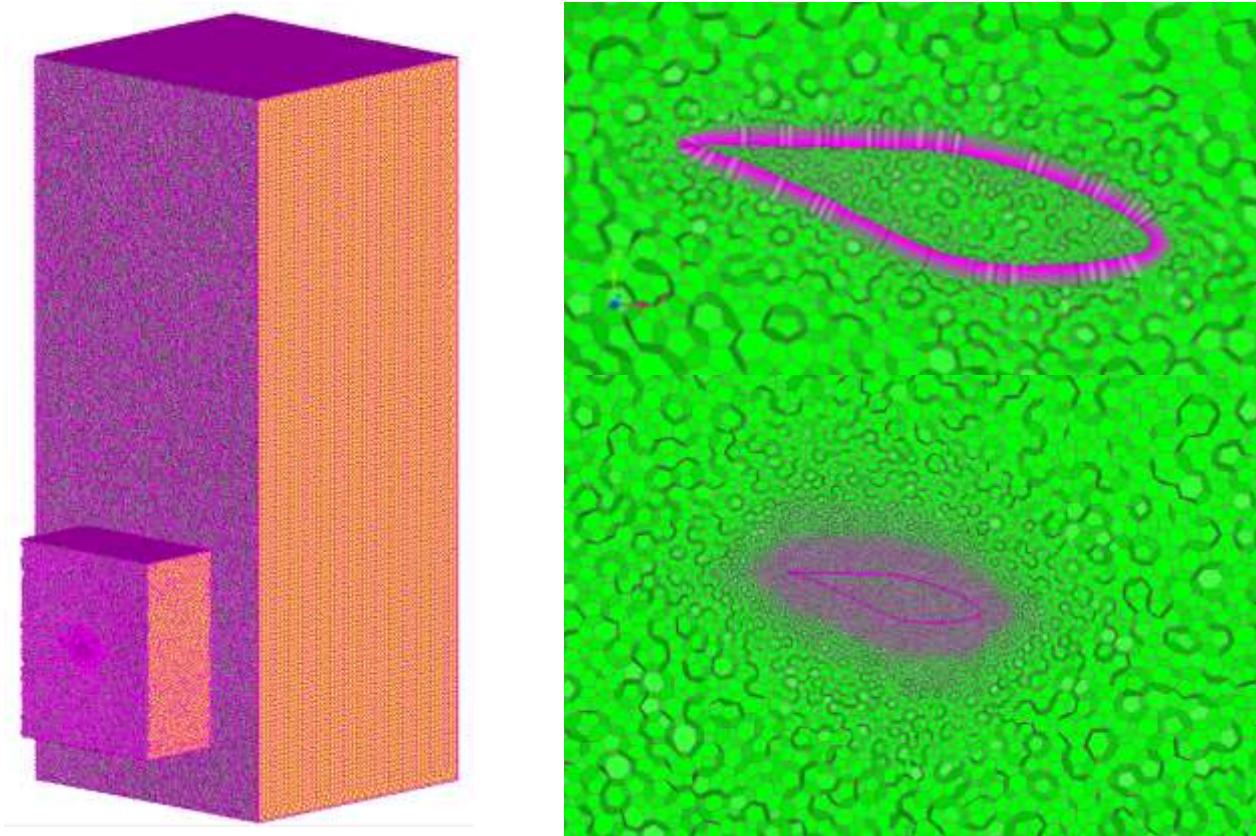

Fig. 8. Mesh Mesh and Boundary Layer Thickness on Blade Models

The mesh structure used in the software process has used as the honeycomb structure. The mesh structures of the blades with reference blade and tubercle structures are shown as in fig.8. After determining the fluid velocity, mesh independence has been made based on the reference blade, which has been applied in all models. According to mesh independence, Version-13 (1.515.320,00 [free flow area] + 2.846.524,00[blade circumference volume] = 3.886.844,00 total number of meshes) has been the mesh model chosen for use in other models to save time and calculation because the change after the change is not too much (Fig. 8). The thickness of the layer to be formed on the blade is shown in Fig. 8, it is set to increase by 1.2 times on each floor.

After determining the fluid velocity, it is necessary to create a network of it in the boundary layer in order to study the boundary layer effects in numerical fluid dynamics and to approximate the solution of the analysis results.

Results

According to Butterfield et al. the S809 airfoil has been created on the basis of experimental data $Re = 300,000$ at Colorado State University in 1992 [24]. However, according to the calculations, when the fluid velocity is taken as 9.96 m/s, it is seen that our numerical model is approximately $Re = 300,097$. The studies were carried out based on this Reynolds number.

**Table 3.** The Numerical Analysis Results

	F_{Trust}	F_{Torque}	Surface Area	C_L	C_D	L/D Aero. Perf.	C_L^3/C_D^2 Aero. Perf.
Model No	(N)	(N)	A (m ²)	Lift Coef.	Drag Coef.	Dif. Betw. Ref. and New Models	Dif. Betw. Ref. and New Models
Ref.	2,07E+02	5,25E+01	4,24E+00	8,34E-01	2,12E-01	3,939	12,937
2	1,78E+02	4,43E+01	3,70E+00	8,20E-01	2,04E-01	1,901%	2,126%
11	1,92E+02	4,74E+01	3,97E+00	8,26E-01	2,04E-01	2,568%	4,183%
24	1,76E+02	4,09E+01	3,89E+00	7,75E-01	1,80E-01	9,282%	10,966%
28	2,02E+02	4,83E+01	4,03E+00	8,55E-01	2,05E-01	5,899%	15,029%
29	1,95E+02	4,07E+01	4,06E+00	8,21E-01	1,71E-01	21,745%	46,022%
30	1,90E+02	4,63E+01	4,04E+00	8,03E-01	1,96E-01	4,075%	4,369%

If attention is paid, it has been observed that C_L increases and C_D decreases in selected models. Only among the models, the Model-28 had this exception (the lift coefficient increased, while the drag Decelerated). Depending on the situation of the models, there is an increase/ decrease in efficiency in different types of results.

When the L/D value has been analyzed, this value, which was 3.94 in the Reference Blade, was observed as 4.01 in Model-2, 4.04 in Model-11, 4.30 in Model-24, 4.17 in Model-28, 4.80 in Model-29, and 4.10 in Model-30. It was observed that the L/D value increased by 1.22 times in the Model-29 compared to the reference blade.

Depending on the analyzes carried out, when the numerical values are examined, it seems that the overall efficiency of the Model-28, Model-29 and Model-30 also increases steadily during the phase.

The models in which the efficiency increase is achieved are as follows.



Model-2



Model-11

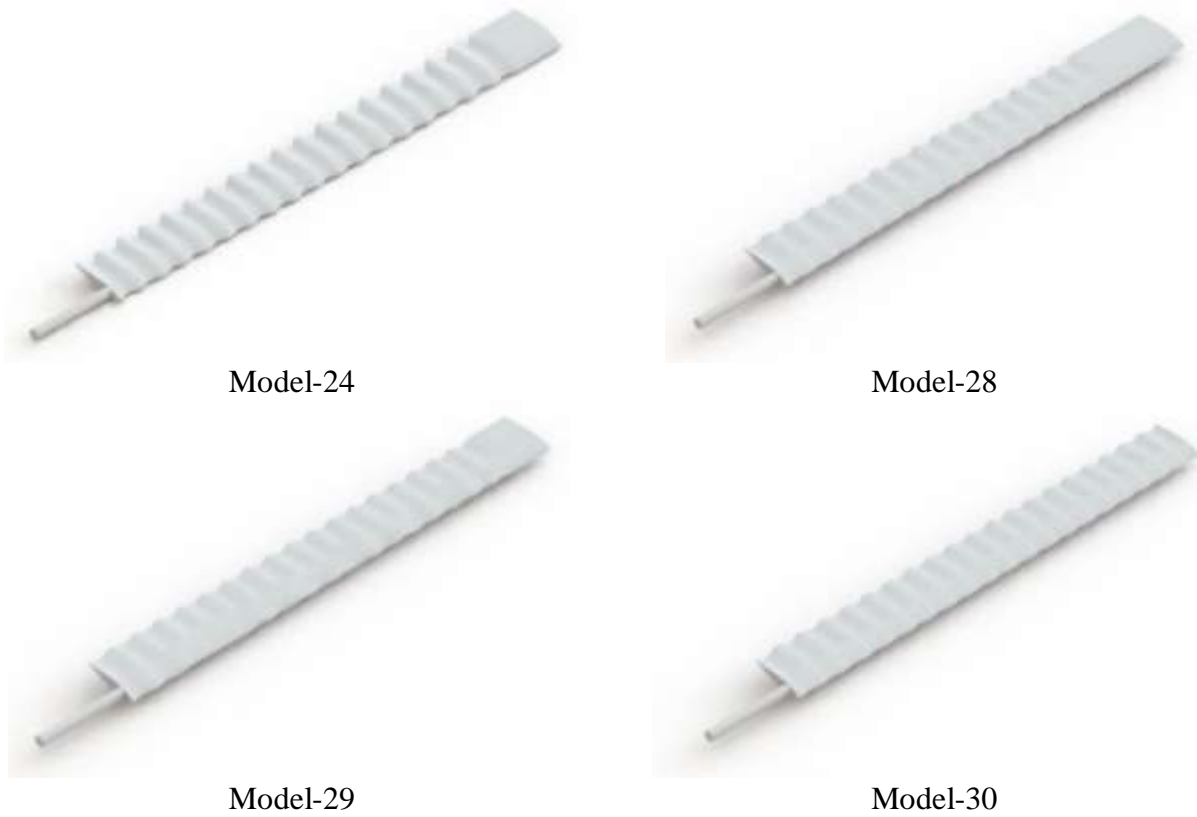

Fig. 9. Efficient modified blades.

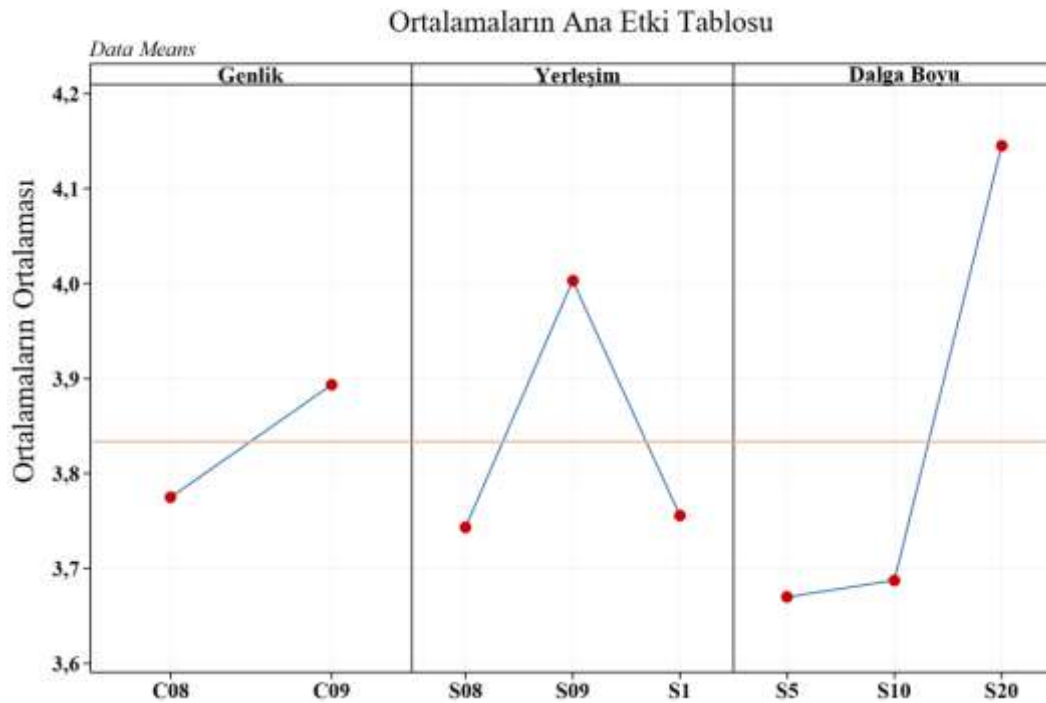

Fig. 10. The Main Impact Assessment Table

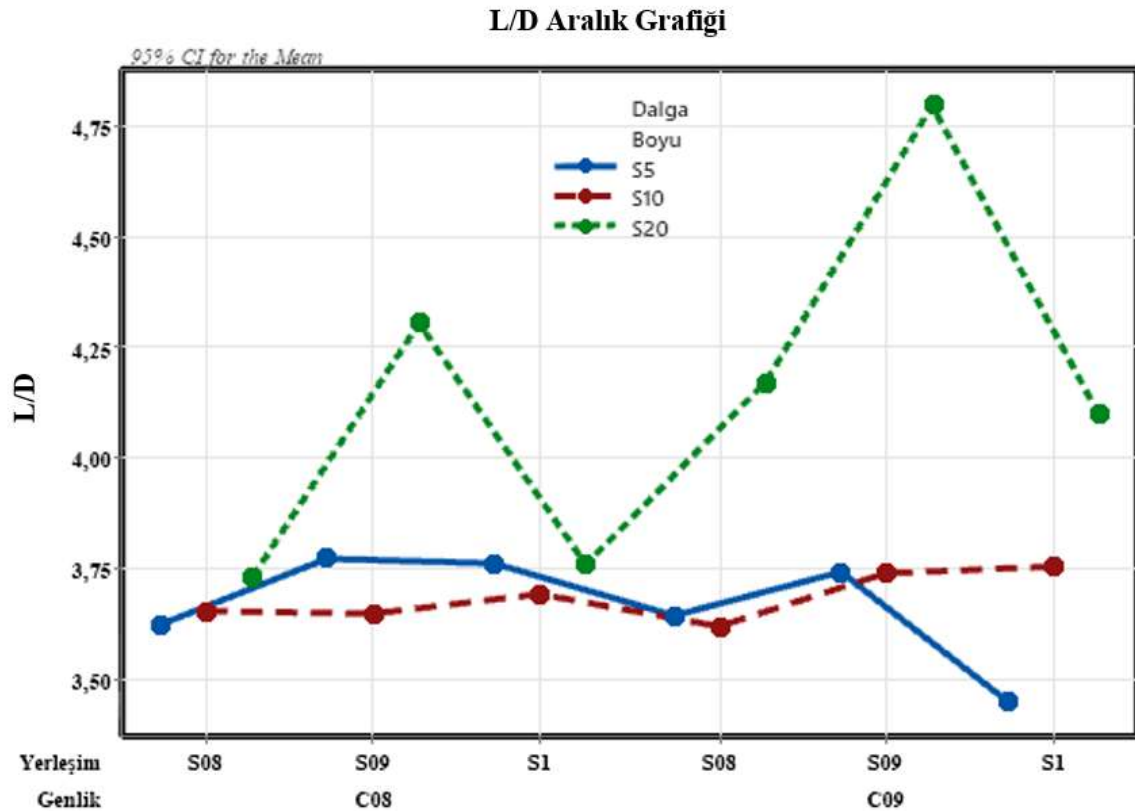

Fig. 11. System Group Parameter Analysis

When the amplitude is evaluated, increasing the amplitude shows that the efficiency of the system increases, and it seems that the fact that more than 80% of the cord is recessed and protruding, and approaching 90% of the wavy structure will have a positive effect on the system. As for the placement / positioning, it seems that increasing the wavy structure up to 80% of the spa to 90% will have a positive effect on the system but increasing it from 90% to 100% will have a negative effect on the system. It is understood from the layout part that increasing this serrated structure along the blade-span will increase the system efficiency, and it seems that the increase in the frequency of serrations ($\text{Span} \cdot 20 > \text{Span} \cdot 10 > \text{Span} \cdot 5$) will continue to have a positive effect on the system.

After examining the effects of the parameters on the system, a group analysis was performed, which was carried out to determine which parameter should be focused on to scale the L/D aerodynamic performance effect on the system. The statistical analysis was carried out in order for the average to be 95% accurate. As can be seen in Figure 5.14, it was also seen in the grouping analysis that the wing structure obtained by dividing the spa by 20 is the most important parameter affecting the system efficiency.

Summary And Conclusion

With the application of this humped structure to the wind turbine blades, the increase/decrease in efficiency on the system caused by the blade performance in the turbines has been examined. First of all, the determined reference blade design has been realized, then 30 models have been created by selecting 2 different amplitudes, 3 different wavelengths and 5 different positioning on the blade. Flow analysis has been performed in the fluid volume for a total of 31 models and it was observed that different parameters affect the results. Among the models created, it has found that the F_{Trust}



value affecting the lift coefficient was the highest on the reference Decking, and it was less on the modified blades.

After the calculation of C_L and C_D , the aerodynamic performance coefficients have been calculated. The L/D applicable to aviation has been calculated as 4.01 in Model-2, 4.04 in Model-11, 4.30 in Model-24, 4.17 in Model-28, 4.80 in Model-29, and 4.10 in Model-30, and it has been observed that this coefficient is 3.94 if it is on the reference blade. In this case, it has been observed that the L/D value increased by 1.22 times in the Model-29 compared to the Reference blade. The C_L^3/C_D^2 value applicable for wind turbine designs has been calculated as 13.21 in Model-2, 13.48 in Model-11, 14.36 in Model-24, 14.88 in Model-28, 18.89 in Model-29, and 13.5 in Model-30, which was 12.94 in the Reference blade. When these data have been discussed, Model-29 has found to be the most efficiency-enhancing.

It was seen that the wavy structure on the blade approaching the 90% part of the cord will have a positive effect on the system, and increasing the wavy structure up to 80% of the spa to 90% in positioning will have a positive effect on the system. However, it seems that increasing it from 90% to 100% will cause a negative impact on the system. It is understood that increasing this serrated structure along the wingspan will increase the system efficiency at the wavelength, and it has been understood that increasing the serrated frequency ($\text{Span}^*20 > \text{Span}^*10 > \text{Span}^*5$) will continue to have a positive effect on the system.

Accordingly, high-capacity computers can be used, different placement / positioning, different wavelength models can be included in the analysis and efficiency comparison can be made in a more sensitive. As a result of statistical analyzes to be carried out together with the augmented models, function equations can be revealed and results can be reached quickly with mathematical methods instead of analysis in the studies to be carried out after that.

References

- [1]. Chehouri, A., Younes, R., Ilinca, A., Perron, J. 2015. “Review of performance optimization techniques applied to wind turbines”, Applied Energy 142[4]:361e88.
- [2]. Genç, M.S., “Control of low Reynolds number flow over aerofoils, and investigation of aerodynamic performance (in Turkish)”, PhD Thesis, Graduate School of Natural and Applied Science, Erciyes University, Kayseri, Turkey, 2009
- [3]. White, F.M., Akışkanlar mekaniği, Çeviri: Kadir Kırkköprü, Erkan Ayder, Literatür Yayıncılık, İstanbul, Türkiye, 2004.
- [4]. Yunus A. ÇENGEL, John M. CIMBALA Akışkanlar Mekaniği Temelleri Ve Uygulamaları Palme Yayıncılık, Ankara, 2013.
- [5]. Wood D., 2011. Small wind turbines. Green Energy and Technology, Springer, 291 s..
- [6]. Zhang, R.-K., and Wu, J.-Z., “Aerodynamic Characteristics of Wind Turbine Blades with a Sinusoidal Leading Edge,” Wind Energy, Vol. 15, No. 3, 2012, pp. 407–424. doi:10.1002/we.v15.3
- [7]. V. V. Kozlov Et Al. - Experimental Investigation Of Localized Disturbances In The Straight Wing Boundary Layer, Generated By Finite Surface Vibrations - Proceedings Of The XXV Conference On High-Energy Processes In Condensed Matter (HEPCM 2017)
- [8]. Fish FE, Battle JM. Hydrodynamic design of the humpback whale flipper. J Morph 1995; 225:51–60.



- [9]. Fish, F.E., Weber, P.W., Murray, M.M., Howle, L.E. 2011. The tubercles on humpback whales' flippers: application of bio-inspired technology. *Integrative and Comparative Biology*, 51:203–13.
- [10]. Owen JC, Szewczyk AA, BearmanPW.2000. Suppression of karman vortex shedding, *Gallery of Fluid Motion*. *Phys. Fluids* 12:1–13
- [11]. Bearman PW, Owen JC. 1998. Reduction of bluff-body drag and suppression of vortex shedding by the introduction of wavy separation lines. *J. Fluid Struct.* 12:123–30
- [12]. Miklosovic DS, Murray MM, Howle LE, Fish FE. 2004. Leading edge tubercles delay stall on humpback whale (*Megaptera novaeangliae*) flippers. *Phys. Fluids* 16:L39–L42
- [13]. Watts, P., and Fish, F. E., “The Influence of Passive, Leading Edge Tubercles on Wing Performance,” *Proceedings of Unmanned Untethered Submersible Technology (UUST), Autonomous Undersea Systems Inst., Lee, New Hampshire, Aug. 2001.*
- [14]. Custodio, D., “The Effect of Humpback Whale-like Leading Edge Protuberances on Hydrofoil Performance,” M.S. Thesis, Mechanical Engineering Dept., Worcester Polytechnic Inst., Worcester, MA, 2007
- [15]. Shi, W., Atlar, M., Norman, R., Aktas, B., and Turkmen, S., “Numerical Optimization and Experimental Validation for a Tidal Turbine Blade with Leading-Edge Tubercles,” *Renewable Energy*, Vol. 96, Part A, 2016, pp. 42–55. doi: 10.1016/j.renene.2016.04.064
- [16]. Butt, F. R., Talha, T. 2019. Numerical investigation of the effect of leading-edge tubercles on propeller performance. *Journal of Aircraft*, 56(3): 1014-1028.
- [17]. Shi W, Atlar M, Norman R, learning from humpback whales for improving the energy capturing performance of tidal turbine blades, *Trends and Challenges in Maritime Energy Management*, Springer, pp. 479–497.
- [18]. H. Johari, C. W. Henoch, D. Custodio, and A. Levshin, “Effects of leading-edge protuberances on airfoil performance,” *AIAA journal*, vol. 45, no. 11, pp. 2634– 2642, 2007.
- [19]. Ramsay, R. F., Hoffman, M. J., & Gregorek, G. M. 1995. Effects of grit roughness and pitch oscillations on the S809 airfoil (No. NREL/TP-442-7817). National Renewable Energy Lab. (NREL), Golden, CO (United States).
- [20]. Schepers, J. G., Brand, A. J., Bruining, A., Graham, J. M. R., Hand, M. M., Infield, D. G., ... Simms, D. A. 1997. Final report of IEA annex XIV: field rotor aerodynamics. Petten, The Netherlands: Energieonderzoek Centrum Nederland.
- [21]. Simms, D. A., Hand, M. M., Fingersh, L. J., & Jager, D. W. 1999. Unsteady aerodynamics experiment phases II-IV test configurations and available data campaigns (No. NREL/TP-500-25950). National Renewable Energy Lab.(NREL), Golden, CO (United States).
- [22]. Hand, M. M., Simms, D. A., Fingersh, L. J., Jager, D. W., Cotrell, J. R., Schreck, S., Larwood, S. M. 2001. Unsteady aerodynamics experiment phase VI: wind tunnel test configurations and available data campaigns (No. NREL/TP-500-29955). National Renewable Energy Lab., Golden, CO.(US).
- [23]. Rojratsirikul, P., Genc, M. S., Wang, Z., Gursul, I. 2011. Flow-induced vibrations of low aspect ratio rectangular membrane wings. *Journal of Fluids and Structures*, 27(8): 1296-1309.
- [24]. Butterfield, C. P., Musial, W. P., & Simms, D. A. 1992. Combined experiment phase 1. Final report (No. NREL/TP-257-4655). National Renewable Energy Lab., Golden, CO (United States).



DESIGN OF GLASS REINFORCED RECYCLABLE COMPOSITE WIND TURBINE BLADE AND ANALYSIS

Caner KALKAN

Sinem KESKİN

Mustafa Serdar GENÇ

Berkay AYDOĞAN

Energy Systems Engineering”, Erciyes University ,38039, Kayseri, Turkey

Wind Engineering ve Aerodynamic Research Group”, Erciyes University, 38039, Kayseri, Turkey

MSG Technology Co. Ltd., Erciyes Technopark, Techno-1 Building No:61/20, 38039, Kayseri, Turkey

Mechanical Engineering”, Ege University, 35040, Bornava, İzmir

Abstract

The aim of this study is to make the non-recyclable wind turbine blades, which are normally designed with epoxy resin, recyclable by designing them with a thermoplastic resin. Within the scope of this research, a real wind turbine blade was designed in line with the required parameters and its fluid structural integrated analysis was performed. The blade model is designed over 12 stations. As the blade model, NACA 4424 profile was used in the first 3 stations in the root region and NACA 4412 profile was used in the remaining 9 stations. In the project, blade design parameters were specified one by one, fluid analysis of the blade was made, lift, drag and pressure distributions were found. Subsequently, it was connected to the static structural part of the analysis software and various deformation analyzes were carried out. In addition, the material properties of the composite structure were calculated according to the formulation of recyclable thermoplastic resin and glass fiber mixtures. Polypropylene, which has more suitable physical and chemical properties for this study, was used as the thermoplastic resin.

Keywords: Thermoplastic, Thermoset, Glass fiber, FSI, Deformation, Stress

1. Introduction

With the developing world, human beings have turned to new and environmentally friendly technologies. Wind turbines are an important clean energy source that keeps up with this developing world. Investments in this clean and renewable energy source continue very rapidly.

Wind turbine types have two different configurations, HAWT and VAWT. These two configurations have instantly distinguishable rotor designs, each with its own unique characteristics [1]. The main development of VAWT, which has been discontinued, can be attributed to its low end speed ratio and difficulty controlling rotor speed. Difficulties in starting vertical turbines have also hindered development that was until recently believed to be incapable of self-starting [2]. However, the VAWT does not require an additional upwind mechanism and heavy generator equipment can be ground mounted, thus reducing tower loads. Therefore, VAWT is not completely ignored for future development. A new V-shaped VAWT rotor design using these positive features is currently under investigation [3]. This design is currently unproven at megawatt scale and requires several years of development before it can be considered competitive. In addition to the problems with alternative



designs, the popularity of HAWT can be attributed to increased rotor control through pitch and yaw control. This is why HAWT has emerged as the dominant design configuration, capitalized by all of today's leading large-scale turbine manufacturers.

High rotor efficiency is desirable for increased wind energy extraction and should be maximised within the limits of affordable production. Energy (P) carried by moving air is expressed as a sum of its kinetic energy [Equation (1.1)]:

$$P = \frac{1}{2} \rho AV^3 \tag{1.1}$$

A physical limit exists to the quantity of energy that can be extracted, which is independent of design. The energy extraction is maintained in a flow process through the reduction of kinetic energy and subsequent velocity of the wind. The magnitude of energy harnessed is a function of the reduction in air speed over the turbine. 100% extraction would imply zero final velocity and therefore zero flow. The zero flow scenario cannot be achieved hence all the winds kinetic energy may not be utilised. This principle is widely accepted [4,5] and indicates that wind turbine efficiency cannot exceed 59.3%. This parameter is commonly known as the power coefficient C_p , where $\max C_p = 0.593$ referred to as the Betz limit [6]. The Betz theory assumes constant linear velocity. Therefore, any rotational forces such as wake rotation, turbulence caused by drag or vortex shedding (tip losses) will further reduce the maximum efficiency. Efficiency losses are generally reduced by:

- avoiding low tip speed ratios which increase wake rotation,
- selecting airfoils which have a high lift to drag ratio,
- specialised tip geometries.

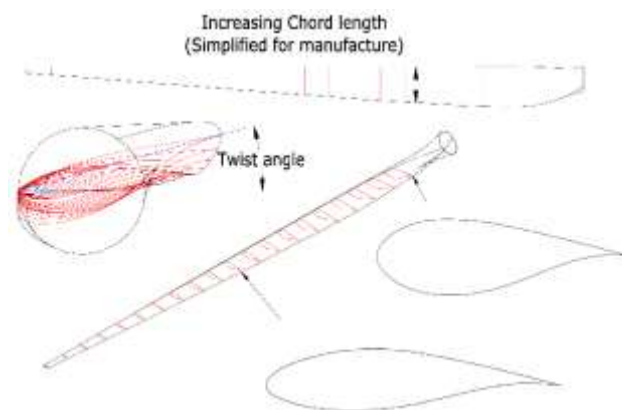

Fig.1. A typical modern HAWT blade with multiple aerofoil profiles, twist and linear chord length increase.

One of the important parameters for the design of the wind turbine blade is blade material. It is desirable that the wind turbine blade materials have the following properties;

- to be able to withstand the loads that affect on blade,
- to reduce the gravitational forces acting on blade low density,
- long fatigue life.



In general, steel in wind turbine blades, aluminum, glass or carbon reinforced composite materials and wood are used. Generally at rather small a wind turbine blades are made in steel. In modern and big wind turbine blades, glass fiber and carbon fiber composites are widely used.

Composite materials are defined as the combination of two or more materials at the macroscopic level. The aim in the development of composite materials is to obtain the properties that the materials that make up the structure did not have before the composite structure by combining these materials. Composite materials consist of a combination of at least two different materials, matrix and reinforcement material. Reinforcement materials take on the task of carrying the loads coming into the structure, and the matrix structure around it keeps the reinforcement elements together, it serves to support them and protect them from external influences.[7]

Composite materials are divided into two groups as thermoset and thermoplastic materials. Epoxy resin from the thermoset group is generally used in wind turbine blades.

Turbines that convert wind energy into electricity also have their own carbon footprints. For this reason, companies that manufacture turbine parts are working to reduce this carbon footprint.[8]

The advantages of thermoplastic resins include the shorter manufacturing cycle, possibility of joining without additional adhesives, and recyclability by heating. The disadvantages include high temperature processing, drying and cooling requirements, surface treatment requirements. In a number of works and projects, the possibility to develop wind turbine blades from thermoplastic polymers has been explored [9,10]. Lystrup [11] explored the potential of polypropylene and polyethylene polymers, studied the fatigue performance of glass fibers with these systems. Tusavul et al. [12] investigated the injection molded thermoplastic polyether ether ketone (PEEK) with 40% carbon fillers, as a replacement for thermoset composites, and demonstrated that the material can potentially provide up to 28% reduction in weight and higher stiffness without significant reduction in elongation.

In the Duwind project (TU Delft), a technology of vacuum infusion of thermoplastic composites was developed [9,13,14]. The thermoplastic polymer used was anionic polyamide-6 (APA-6), with viscosity one tenth of that of epoxy and low processing temperature. Van Rijswijk applied this technology to manufacture 25 mm thick thermoplastic composites with a fiber volume content of 50%. Joncas [15] analyzed the usability of reactively processed APA-6 in blades and proposed special topology-optimized blade design. He demonstrated also recycling of APA-6/glass long-fiber composites into APA-6 short-fiber reinforced composites by regrinding and injection molding, with rather good properties.

Irish company ÉireComposites manufactured 12.6 m long blade using cyclic butylene terephthalate (CBT), using the own heated ceramic/thermoplastic tooling technology.

Garate et al. [16] developed vacuum-assisted thermoforming for manufacturing of small segments of thermoplastic (polypropylene resin) composites, and tested the segmented wind blades at a small-scale wind farm. Durai Prabhakaran [17,18,19] reviewed applicability of commingled (hybrid yarns), prepreg (pre-impregnated tapes), or reactive based polymers (anionic polyamide 6/APA6 and cyclic butylene terephthalate/CBT) for wind turbine blades. Durai Prabhakaran concluded that the reactive polymers have potential to replace the thermoset resins in large blades, thanks to their low viscosities. Durai Prabhakaran et al. [17] also compared mechanical properties for various glass reinforced thermoplastic laminates (flexible, compression strength, moduli, interlaminar shear strength). An important subject is the development of fiber sizing, which should prevent the properties (in particular, interface properties) decrease due to moisture uptake [9]. The authors listed the main challenges of application of thermoplastic composites in wind blades, among them, high temperature processing and thus higher blade costs, drying requirements, faster cooling rate to



minimize void formation, fiber adhesion and surface treatment requirements, control of resin flow. Extensive research on fiber surface treatments and sizing is also underway to augment the fiber/matrix chemical bond, further increasing static and fatigue properties.

French company Arkema developed Elium liquid thermoplastic resin for the manufacture of composite parts with the same technologies and processing equipment as for thermoset composites. In the French Effiwind project the partners sought to develop and validate technologies of manufacturing Elium blades and produced the first 25-meter blade in 2016. Elium shows the mechanical properties, close to those of epoxies but much higher toughness.

In this study, a recyclable wind turbine blade was designed with real calculations. As the airfoil, NACA 4424 was used at the first three stations and NACA 4412 was used at the next nine stations. In order to make the turbine blade recyclable, polypropylene was used as the material in the thermoplastic material group. The designed blade was first examined aerodynamically in flow analysis and then the effects of this aerodynamics on the blade structure were observed. In other words, fluid-structure interaction analysis was performed.

2. Material and Methods

While designing the blade, the number of stations was determined first. 12 stations were used as stations. NACA 4424 was used in the first 3 stations in the root section and NACA 4412 was used in the other 9 stations. The reason why the NACA 4424 profile is used in the root part is to minimize the deformation in the root part and to have a more robust structure of the root part as it has a thicker structure than the 4412 profile.

After determining the blade stations, the blade length was determined over a certain power calculation in order to bring the blade to the desired model size. In addition, the bending angle of the blade is determined for each profile and the blade is designed accordingly. Chord lengths, which is the last step for the design, were calculated for each blade in accordance with the following formulas.

$$P_{max} = (C_p)_{max} \frac{1}{2} \rho \pi R^2 V_{\infty}^3 \quad (2.1)$$

$$\alpha_B = \frac{2}{3} \left(\tan^{-1} \frac{R}{\lambda_{diz} r} \right) - \alpha_{diz} \quad (2.2)$$

$$C = \frac{1}{B} \frac{16\pi}{c_L} r \left(\sin^2 \left[\frac{1}{3} \left(\tan^{-1} \frac{R}{\lambda r} \right) \right] \right) \quad (2.3)$$



Table 1. Desing Informations

Blade Models	NACA 4424, NACA 4412
Turbine Power	100W
Turbine Pressure Coefficient	0.4
Air Density	1.225
Blade Length	0.840189505m
Flow Rate	6 m/s
Angle of Attack	43 Degrees
λ	6
Lift Coefficient	0.8

Table 2. Blade Parameters Resulting From Calculations

r (distance between stations)	Twist Angle	Chord Length
0.064629962 m	36.28996634	0.17613733 m
0.129259924 m	23.99998875	0.181346117 m
0.193889886 m	16.46003463	0.154011397 m
0.258519848 m	11.71002511	0.128286906 m
0.32314981 m	8.53426523	0.108293885 m
0.387779772 m	6.28995413	0.093060184 m
0.452409733 m	4.630257989	0.081304933 m
0.517039695 m	3.357490349	0.072047761 m
0.581669657 m	2.352333706	0.064608091 m
0.646299619 m	1.539950654	0.058517705 m
0.710929581 m	0.869893685	0.05345021 m
0.775559543 m	0.308211155	0.049174206 m



Fig.2 Blade designed in CAD program

The blade designed according to the actual wind turbine blade design parameters obtained from the above calculations is shown in **Fig.2**.

2.1. Fiber reinforced composites

Generally, epoxy matrix material composites with carbon and glass fiber reinforcement elements are used in wind turbine blades. Polypropylene from thermoplastic resins was chosen to make the blade recyclable. Here, a composite structure consisting of 30% glass fiber and 70% polypropylene was formed. The reason why we use glass fiber more is because glass fiber is a little more unstable than materials such as carbon fiber.

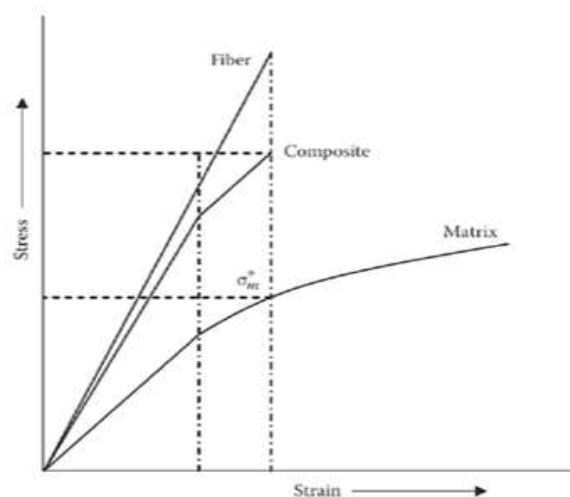
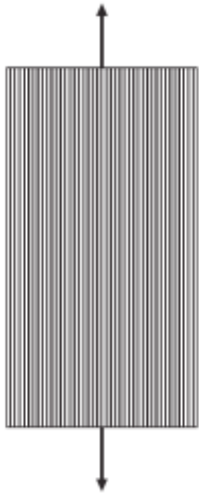

Fig.3 Stress-strain plot for fiber-reinforced composites



$$F_c = F_f + F_m$$

$$\sigma = \frac{F}{A} \longrightarrow F = \sigma A$$

$$\sigma_c A_c = \sigma_f A_f + \sigma_m A_m \longrightarrow \rho_c = \rho_f \frac{A_f}{A_c} + \rho_m \frac{A_m}{A_c}$$

$$\varepsilon_c = \varepsilon_f = \varepsilon_m$$

$$E = \frac{\sigma}{\varepsilon}$$

$$\frac{\sigma_c}{\varepsilon_c} = \frac{\sigma_f}{\varepsilon_f} V_f + \frac{\sigma_m}{\varepsilon_m} V_m \quad E_c = E_f V_f + E_m V_m$$

Fig.4. Under parallel load

2.2 Fiber Reinforced Composites Under Horizontal Load

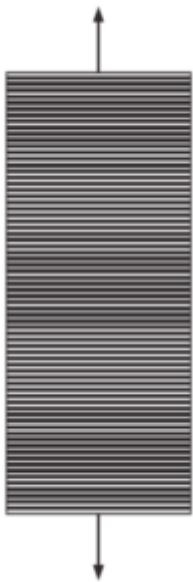

$$\sigma_c = \sigma_f = \sigma_m$$

$$d_c = d_f + d_m$$

$$d_c = \varepsilon_c t_c$$

$$d_m = \varepsilon_m t_m$$

$$d_f = \varepsilon_f t_f$$

$$\varepsilon_c t_c = \varepsilon_m t_m + \varepsilon_f t_f$$

$$\varepsilon_c = \varepsilon_f \frac{t_f}{t_c} + \varepsilon_m \frac{t_m}{t_c}$$

$$\varepsilon_c = \varepsilon_f V_f + \varepsilon_m V_m$$

$$\varepsilon_c = \frac{\sigma}{E}$$

$$\frac{\sigma_c}{E_c} = \frac{\sigma_f}{E_f} V_f + \frac{\sigma_m}{E_m} V_m \quad \sigma_c = \sigma_f = \sigma_m$$

$$\frac{1}{E_c} = \frac{V_f}{E_f} + \frac{V_m}{E_m}$$

Fig.5. Under Horizontal Load

$$\frac{E_f E_m}{V_f E_m + (1 - V_f) E_f}$$

$$E_c = \frac{E_f E_m}{V_f E_m + V_m E_f} =$$

2.3. Composite Poisson Ratio

$$X_c = X_f V_f + X_m V_m$$



X_c = Composite poisson ratio

X_f =Poisson's ratio of fiber material

X_m = volume fraction of matrix material

V_m =Poisson's ratio of matrix material

V_f =volume fraction of fiber material

- The poisson ratio of glass fiber, which is a composite material, is 0.21
- Volume fraction of composite material 0.3
- The Poisson ratio of the matrix material, polypropylene, is 0.43
- The volume fraction of the matrix material is 0.7

As a result of the calculation, the poisson ratio of the polypropylene matrix carbon fiber reinforced material is 0.364. Polypropylene was chosen as the thermoplastic because it has very good resistance to fatigue and high impact strength. Standard analysis was performed in 5000 iterations with the sst-k omega turbulence model under $Re = 70000$. During the calculation of Reynolds, the maximum court length of the blade was taken as a basis. Then, one-way fluid structural interaction is done.

Results

Under this section, the effect of the flow analysis coming from the fluent part on the blade is obsorved. By combining fluent and mechanical measurements, we performed the FSI analysis.

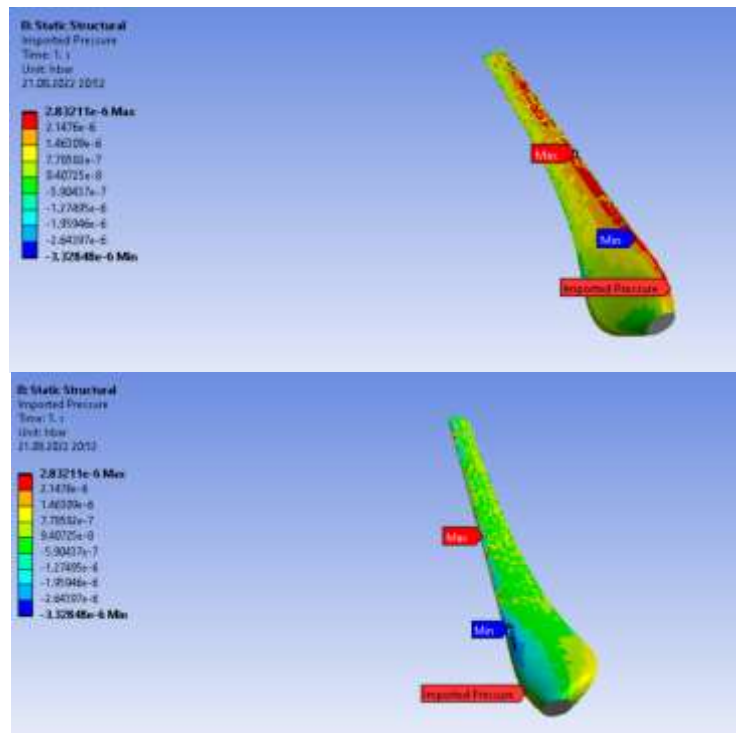

Fig.6 Pressure distributions in the upper and lower parts of the blade



The pressure contours on the blade are given above. It is clearly seen that the pressure is low in the upper part of the blade and high in the lower part of the blade. From this inference, it can be said that there is a lift force as expected on the blade.

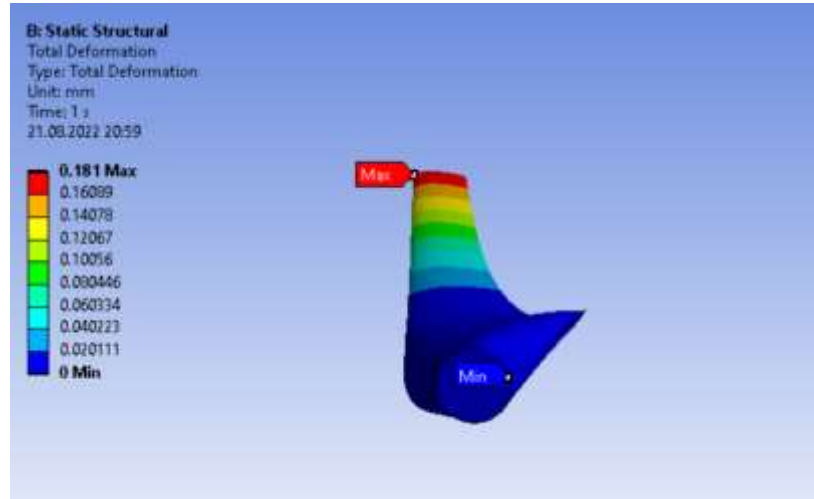

Fig.7 Total Deformation

Fig.7 shows that the overall deformation is more intense at the tip of the blade. The maximum deformation occurs at 0.181 mm. The deformation is acceptable considering the dimensions of the blade.

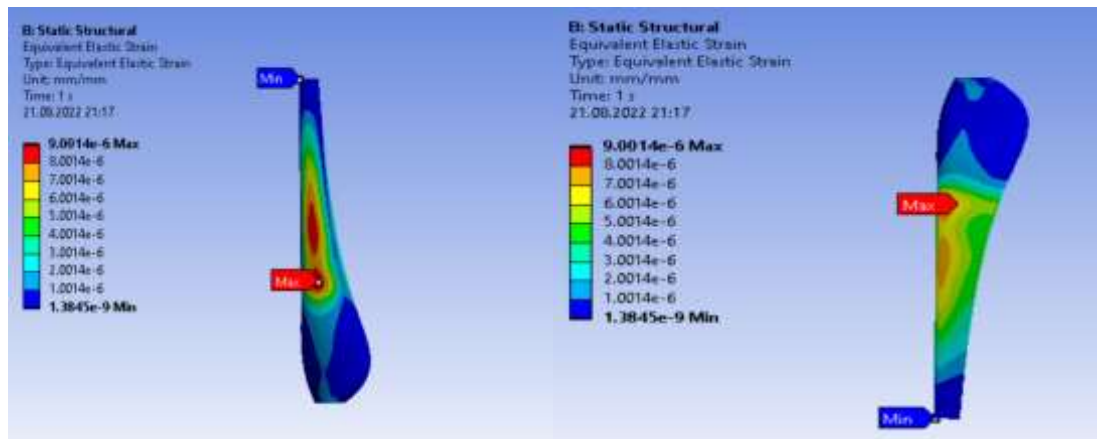

Fig.8 Equivalent elastic strain in the upper and lower parts of the blade

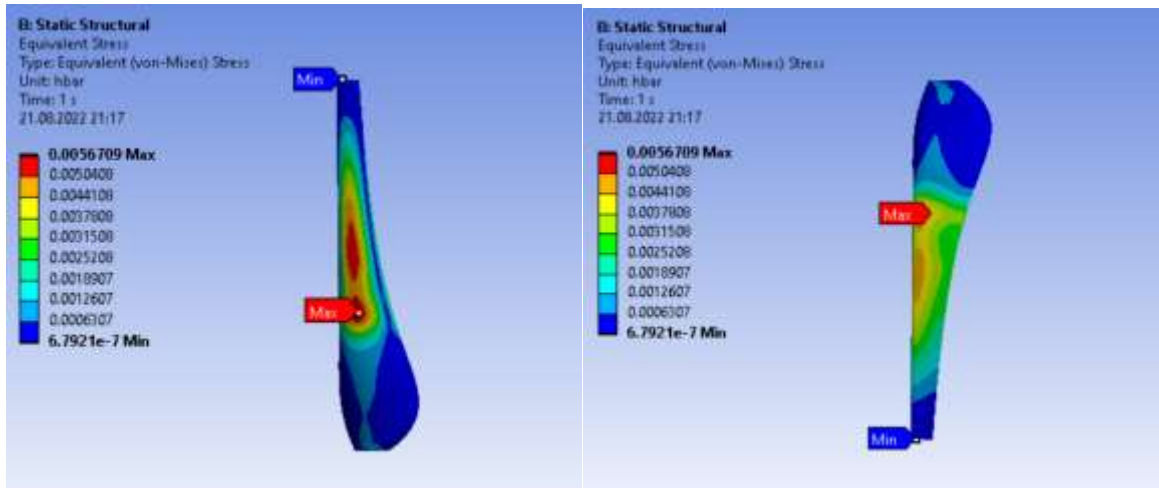

Fig.9 Equivalent stress in the upper and lower parts of the blade

The stress and strain contours and values in Fig.8 and Fig.9 density is seen in certain parts of the blade. This density proves us that the blade can be produced and used in real life since it is not great enough to affect the performance of the blade and the physical deformations on the blade.

Summary And Conclusion

In this study, it was designed a real wind turbine blade in model dimensions and with an innovative approach, we performed a preliminary simulation of a recyclable wind turbine blade, using a thermoplastic resin, polypropylene, instead of epoxy resin. One way FSI is used as the FSI type. The results were examined, it can be said that the analysis results are close to a normal epoxy resin blade.

It can be said that the expected results are obtained when the analysis results in both the fluid part and the structural part are examined. Although it should be said that the polypropylene used here does not have as good properties as epoxy resin, it is aimed to show that the most important aim of this approach is to design a recyclable blade with a thermoplastic resin instead of destroying the wind turbine blades after use. The results of the analysis indicate that it is possible to produce and use such an environmentally friendly design. Owing to this design, it can be said that companies will recycle blades worth millions of euros and make a huge profit.

Acknowledgements

The authors thank the Scientific and Technological Research Council of Turkey (TÜBİTAK) for the Scholarship for University Students Industry-Oriented Research Projects Support Program 2209/B under the contract number: 1139B412102996 for the Caner KALKAN.

References

- [1]. Hau, E. Wind Turbines, Fundamentals, Technologies, Application, Economics, 2nd ed.; Springer: Berlin, Germany, 2006.
- [2]. Dominy, R.; Lunt, P.; Bickerdyke, A.; Dominy, J. Self-starting capability of a darrieus turbine. Proc. Inst. Mech. Eng. Part A J. Power Energy 2007, 221, 111–120.
- [3]. Holdsworth, B. Green Light for Unique NOVA Offshore Wind Turbine. 2009.



- [4]. Gasch, R.; Twele, J. Wind Power Plants; Solarpraxis: Berlin, Germany, 2002.
- [5]. Gorban, A.N.; Gorlov, A.M.; Silantyev, V.M. Limits of the turbine efficiency for free fluid flow. *J. Energy Resour. Technol. Trans. ASME* 2001, 123, 311–317
- [6]. Burton, T. Wind Energy Handbook; John Wiley & Sons Ltd.: Chichester, UK, 2011.
- [7]. Uysal, A. 2008. “Rüzgâr Türbini Kanat Malzemelerinin Mekanik Özelliklerinin İncelenmesi,” Yüksek Lisans Tezi, Yıldız Teknik Üniversitesi, Fen Bilimleri Enstitüsü, İstanbul, s. 95.
- [8]. GE Türkiye Blog. “Geri Dönüştürülebilir Rüzgâr Türbini Kanadının Prototipi Tanıtıldı” 5 Nisan 2022.
- [9]. Gardiner, G. Thermoplastic Wind Blades: To Be or Not? 3/31/2012, Composites World. Available
- [10]. Mathijssen, D. Trailblazing thermoplastics for wind turbine blades. *Reinforced Plastics* 2013, 57, 36–39.
- [11]. Lystrup, A. Vacuum consolidated of thermoplastic composites for wind turbine rotor blades. In *Proceedings of the 27th Risø International Symposium on Materials Science: Polymer Composite Materials for Wind Power Turbines*, Risø National Laboratory, Roskilde, Denmark; 2006; pp. 231–238.
- [12]. Tusavul, S.; Fragoudakis, R.; Saigal, A.; Zimmerman, A. Thermoplastic materials for wind turbine blade design. In *Proceedings of the ACEM 2014 Congress*, Busan, Korea, 24–28 August 2014; pp. 1–7.
- [13]. Van Rijswijk, K. Thermoplastic Composite Wind Turbine Blades: Vacuum Infusion Technology for Anionic Polyamide-6 Composites. Ph.D. Thesis, Delft University of Technology, Delft, The Netherlands, April 2007.
- [14]. Teuwen, J.J.; Van Geenen, A.; Bersee, H.E. Vacuum-infused anionic polyamide-6 composites: The effect of postprocessing. *J. Thermoplast. Compos. Mater.* 2011, 25, 965–986.
- [15]. Joncas, S. Thermoplastic Composite Wind Turbine Blades. An Integrated Design Approach. Ph.D. Thesis, Delft University of Technology, Delft, The Netherlands, July 2010.
- [16]. Garate, J.; Solovitz, S.A.; Kim, D. Fabrication and performance of segmented thermoplastic composite wind turbine blades. *Int. J. Precis. Eng. Manuf. Technol.* 2018, 5, 271–277.
- [17]. Durai Prabhakaran, R.T. Future perspectives and challenges of thermoplastic wind blades. Abstracts. Indo-Danish Workshop on Future Composites Technologies for Wind Turbine Blades. DTU Risø. 2012.
- [18]. Raghavalu Thirumalai, D.P. A critical review of future materials for wind turbine blades. *Int. J. Mater. Eng. Innov.* 2014, 5, 81–99
- [19]. Durai Prabhakaran, R.T. Are Reactive Thermoplastic Polymers Suitable for Future Wind Turbine Composite Materials Blades? *Mech. Adv. Mater. Struct.* 2014, 21, 213–221.



HOURLY ELECTRICITY LOAD FORECASTING IN KAYSERİ WITH MULTIPLE REGRESSION

Gamze GENÇ
Aslıhan BAYYİĞİT
Sevde ERTÜRK

Erciyes Üniversitesi Mühendislik Fakültesi Enerji Sistemleri Mühendisliği Bölümü, Kayseri,
TÜRKİYE

Abstract

The rapid development of technology has increased the demand for energy considerably and it requires the establishment of versatile energy generation, transmission and distribution systems for the future. Load forecasting has great importance in the planning of capacity in terms of energy generation, transmission, and distribution. The electricity demand forecasts made by the Ministry of Energy and Natural Resources are used by some public institutions in production capacity planning. In addition, utilities' operation and load planning are significantly affected by the accuracy and reliability of the models used for electrical load estimation. In this study, load estimation is made for the transmission system in Kayseri province by using multiple regression models considering regional environmental conditions such as temperature, humidity and wind. It is found that the estimated values and the actual values are close to each other.

Keywords: Regression analysis, Load forecasting, Artificial Neural Network

INTRODUCTION

Nowadays, as technology advances, there is a steadily growing need for electrical energy. Future-proofing energy generation, transmission, and distribution networks are essential to supplying the world's rising need for energy. Suppose the regional load estimation is made with an optimistic approach while planning the transmission lines. In that instance, the current pulled from the line in the following years may be significantly greater than the allowable current capacity. If a pessimistic technique is used to estimate the load, the load current of the line will be much lower than the permitted current capacity. In this scenario, the limit currently foreseen for the installed line will not be reached and the system will be designed with an unnecessarily high capacity, so the cost of installation and investment will increase significantly (Ozturk, 1989). Kandil et al. (2001) performed the load estimation of Egypt with expert systems such as fuzzy logic and Artificial Neural Networks (ANN) depending on the temperature and load change and compared the obtained results. Topalli and Erkmen (2003) published daily load forecasts for Turkey in their study, in which they tried to estimate Turkey's one-day electricity demand using ANNs. Special days, which are considered separately, were excluded from the normal working data, so a solution was obtained for working days, weekends, and special days. Yalçınöz and Eminoğlu (2005) estimated daily total load and daily peak load values for Niğde province. Ceylan and Demirören (2007) ensured a short-term load forecast for the next day using the 2002 and 2003 load data and temperature data of the Gölbaşı region. The accuracy of the load estimation depends on the factors affecting the load and the methods used. Factors such as population density, industrialization, climatic conditions, city planning, turning to electrical tools and equipment, technological developments, and gross national product affect the load considerably.

MATERIALS AND METHODS

Planning of power systems begins with the estimation of the loads that may be added to the system in the future. Load forecasting is essential in determining the capacity of generation, transmission and distribution systems to meet future demands. The demand data to be used should be estimated close to reality to carry out the planning studies in a more reliable way. For an effective system planning, it is necessary to estimate the energy requirement and the amount of peak load. Some factors affecting the load estimation are population growth, load density, use of alternative energy sources, climatic factors, etc. (Cilliyuz, 2003). Short-term load forecasts have gained great importance in recent years due to the increasing competition among energy markets. Short-term load estimation is of great importance for the economic and safe operation of a power system. It also plays a crucial role in the supply industry, as it plays an important role in price agreements. In Figure 1, the short-term load forecasting function is shown schematically.

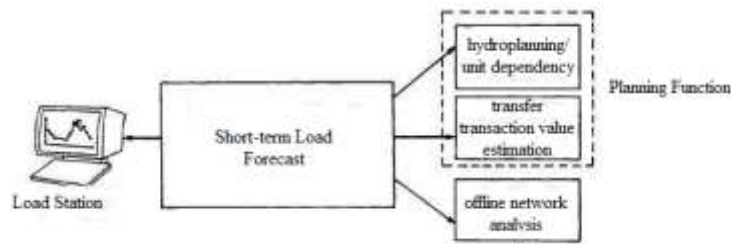

Figure 1. Function of short-term load forecasting

Artificial Neural Network

A basic neural network cell is a type of machine learning that works with a system similar to a biological neuron. There are data, weights, summation function, activation function and outputs received from ANN external environment or other processing units. As seen in Figure2, a multilayer ANN structure calculates the net input of the aggregate function. Incoming information comes to the input layer, and data from each cell is sent to other cells in the hidden layer. At this time, the weight coefficients are multiplied, and when the data coming to the hidden layer leaves here, they become the input data of the cells in the output layer. The information coming out of the cells in the output layer creates the output data. The activation function calculates the net output during the process, and this process also gives the neuron output, the output.

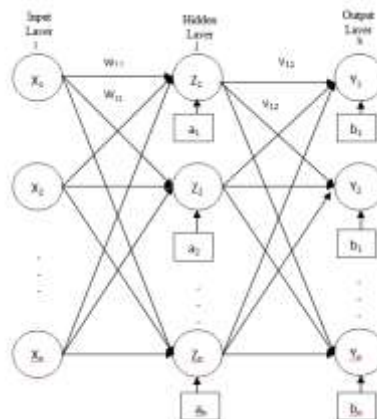

Figure 2. Artificial Neural Network Structure

The input data, called X_i , is multiplied by the weights w_{ij} and the products are summed. That is, weighted addition is done. The bias data called b_j are then added together to obtain a net sum, S_j .

$$S_j = \sum_{i=1}^n X_i w_{ij} + b_j \tag{1}$$



In this study, load estimation was made with ANN using the factors affecting the load estimation as input consisting of the information mentioned above. The future short-term hourly load forecast of the transmission system of Kayseri province has been made. In the study, hourly electricity peak load values obtained from Kayseri and Neighborhood Electricity Distribution Inc. and hourly environmental conditions (temperature, humidity, wind) obtained from Kayseri Meteorology Regional Directorate were used. The hourly load forecast of the region for the future was made by using a multiple regression model, considering environmental factors.

RESULTS AND DISCUSSION

The relationship between MATLAB boxplot and hourly load peak data (kWh), which is the dependent variable, and environmental conditions, each of which is an independent variable, was examined. There is a strong relationship between temperature change and electrical load usage.

The effect of temperature on load estimation is shown in Figure 3a. When Figure 3a and 3b are compared, it is seen that the effect of both is similar. The reason for this is that the temperature changes according to the time of the day. Therefore, the time of day is an important variable in electricity use. According to Figure 3c, it can be deduced that there is not a strong relationship since there is not enough data between day and electrical load usage. However, similar days can be distinguished from the graph. Figure 3d shows that the electrical load used during the day is affected by the change in humidity. Wind speed variance in Figure 3e shows a fluctuating change. However, its average is gathered around a fixed value.

For future load forecasting, a load forecasting model using regression has been implemented. Multiple regression was performed in the model, taking into account the environmental conditions as well as the load data. These load estimation models were created with the MINITAB package program.

Between input and output in multiple regression analysis correlation can be established as given in below:

$$Y = a + bX \quad (2)$$

where X denotes the $[1 \ P]$ matrix, while the P matrix denotes the input matrix consisting of the independent variables of temperature, humidity, wind, day, and time. The aim is to calculate the b matrix, which consists of coefficients that will enable the calculation of the Y output matrix corresponding to the P input matrix. It will be seen that there is an error up to a between the Y output values found by calculating the b matrix and the real Y values.

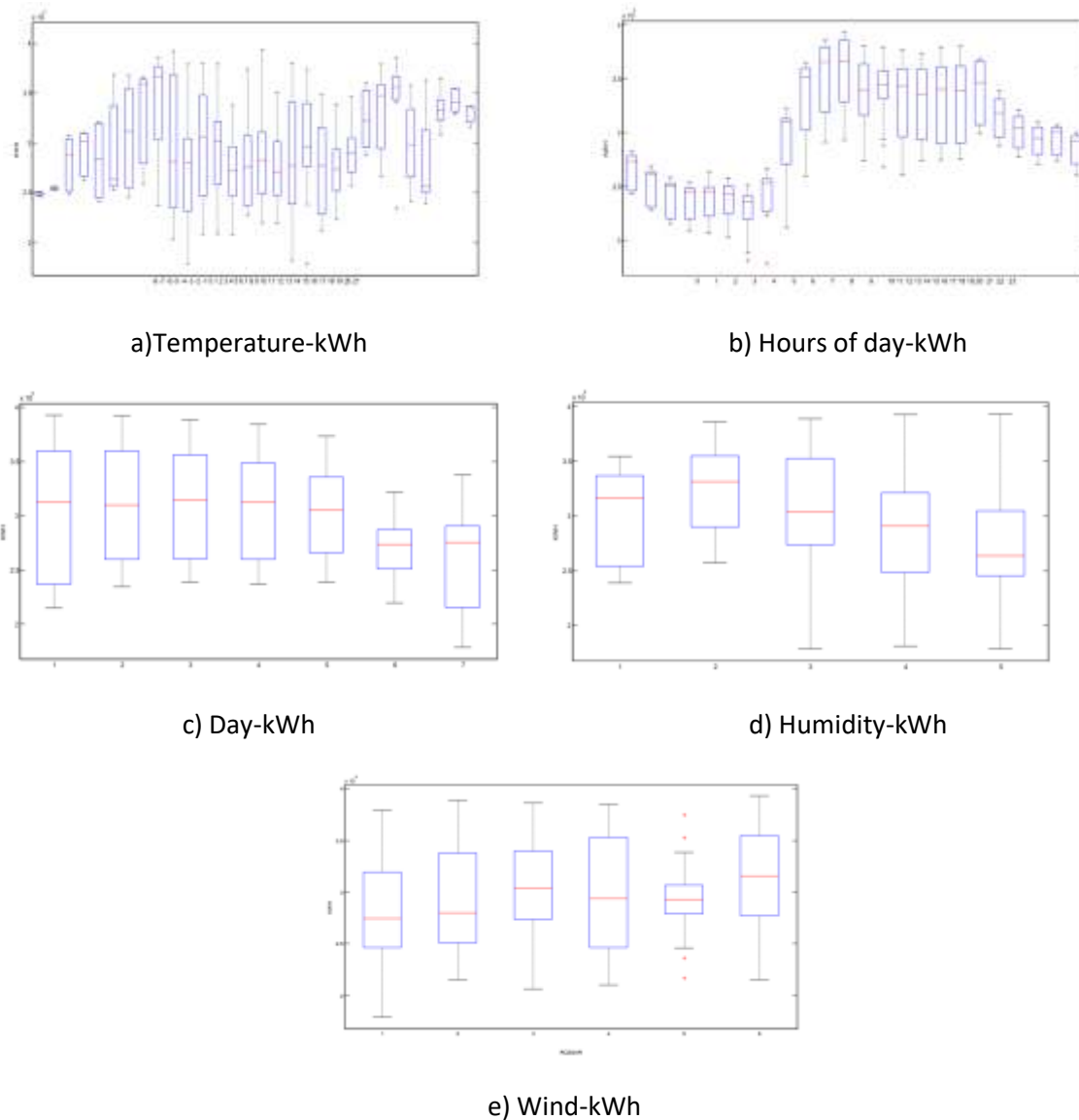

Figure 3. The relationship between load peak data (kWh) and environmental conditions in MATLAB

First of all, the correlation relationship between the independent variables was examined. Relationship between MINITAB Correlations module and temperature, humidity, wind, time, day;

Correlations: sıcaklık; nem; rüzgar; saat; gün

	sıcaklık	nem	rüzgar	saat
Humidity	-0,715			
Wind	0,366	-0,397		
Hour	0,750	-0,121	0,064	
Day	0,088	-0,081	0,021	0,000

Cell Contents: Pearson correlation

Figure 4. Relationship between MINITAB Correlation module and temperature, humidity, wind, time, day



According to Figure 4, it is seen that the temperature has a strong relationship with humidity and time, and the relationship between wind and other independent variables is not strong.

Electric peak load estimation equation when MINITAB is started as given in Equation 3:

$$y_data(kWh) = 356671 - 900temperature - 899humidity - 1wind + 3186hour - 8836day \quad (3)$$

Predictor	Coef	SE Coef	T	P
Constant	356671	12658	28,18	0,000
Tempera.	-900,3	407,2	-2,21	0,028
Humidity	-889,2	134,8	-6,59	0,000
Wind	-1,3	356,9	-0,00	0,997
Hour	3186,4	294,9	10,81	0,000
Day	-8836	1017	-8,69	0,000

S = 37124,9 R-Sq = 44,6% R-Sq(adj) = 43,8%

Figure 5. MINITAB variance analysis result

According to the results of variance analysis, it is understood from the P test results that temperature, humidity, hour, and day are significant variables for the model, but the wind does not contribute to the model. Therefore, the model was reconstructed by extracting the wind data. While the reconstructed equation was the same as the previous equation, the square of the percent errors did not change. It is seen that wind is not an important variable for the model.

As can be seen in Figure 6a, the error difference between the data and the equation established is quite high. In other words, the established equation model cannot make an accurate prediction to the desired extent. Figure 6b shows the normal distribution of the electrical load peak value with the outlier graph. The explanation and use of multiple regression depends on the estimation of the regression coefficients. Influential and outliers can lead to biased estimates, thus rendering analysis results useless. Therefore, it is very important to find outliers. The random distribution of outliers is shown in Figure 6c. Here, it is observed that the independent variables are independent of each other. In addition, in Figure 6d, it is expected to be bumpy but not to vary too much. However, the variance here varies. This is due to the fact that the model does not explain the problem very well.

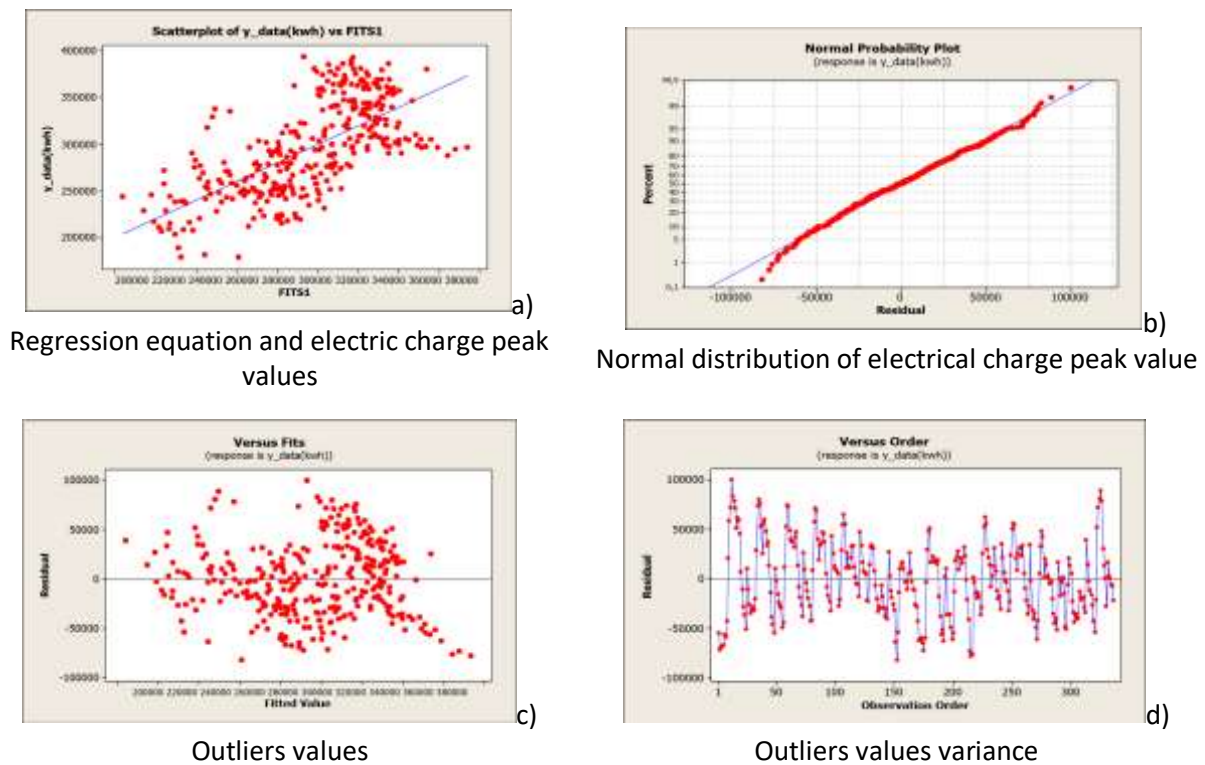

Figure 6. Plots of variance values

CONCLUSION

A regression analysis model was established by using meteorological data such as temperature, humidity and wind in order to associate suitable environmental conditions with electricity consumption between certain dates for the transmission network that feeds the Kayseri region. The difference between the estimated value and the actual value and the average calculated value for that day is added to the increasing load curve in the form of mean squares error, the difference obtained as positive or negative for the test of the accuracy of the system. When Figure 7 is examined, it is seen that the estimated values and the actual values are close to each other.

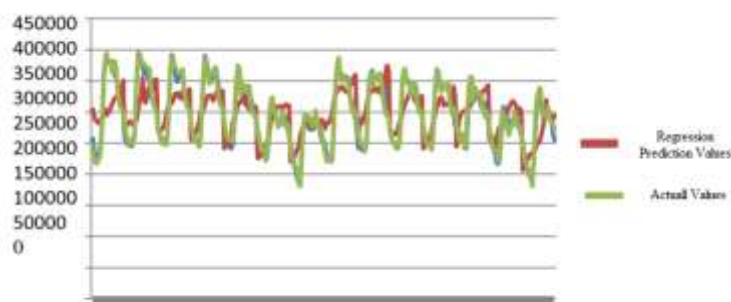

Figure 7. Comparison of actual values and regression values



ACKNOWLEDGEMENTS

One of the authors, Sevde ERTÜRK, would like to thank the Turkish Higher Education Institution YÖK (100/2000 Ph.D. Scholarship Program).

REFERENCES

- Ceylan G, Demirören A 2007, *Yapay Sinir Ağları ile Gölbaşı Bölgesinin Kısa Dönem Yük Tahmini*, Elektrik, Elektronik ve Bilgisayar Mühendisliği Sempozyumu ve Fuar,103-7.
- Çilliyüz Y 2006, *Yapay Sinir Ağları ile Çevre Koşulları Etkili Bölgesel Yük Kestirimi* Master Thesis, Kocaeli University.
- Öztürk S 1989, *Elektrik Üretim Sistemlerinin Optimal Planlanmasında Yeni Bir Modelleme ve Çözüm*, PhD Thesis, Marmara University.
- Kandil MS, El-Debeiky SM, Hasanien NE 2002, *Long-Term Load Forecasting for Fast Developing Utility Using a Knowledge-Based Expert System*, IEEE Transactions on Power Systems, 17:491–496.
- Topallı AK, Erkmen I 2003, *A Hybrid Learning For Neural Networks Applied To Short Term Load Forecasting*, Neurocomputing, 51:495-500.
- Topallı AK, Erkmen I, Topallı AK, Erkmen I 2006, *Intelligent Short-Term Load Forecasting In Turkey*, Electrical Power and Energy Systems, 28:437–47.
- Yalçınöz T, Eminoglu U 2006, *Short Term And Medium Term Power Distribution Load Forecasting By Neural Networks*, Energy Conversion and Management, 46:1393–1405.



EVALUATION OF ENERGY CROPS IN ENERGY AREAS

Tuğba MEŞELİ

Hilal DOĞAN

Gülşah ELDEN

Gamze GENÇ

Erciyes Üniversitesi Mühendislik Fakültesi Enerji Sistemleri Mühendisliği Bölümü, Kayseri,
TÜRKİYE

Abstract

Using renewable energy sources is a crucial way to provide the variety that can significantly mitigate the environmental issues caused by using fossil fuels on a local and global level. Energy crops have been explored in recent years as alternative feedstock for carbonization and represent an important source of carbon, thanks to rapid, abundant biomass production. Energy crops include namely oil-rich crops, sugar crops, which contain sugars directly available for biofuel production, and lignocellulosic crops, which contain tightly bound cellulose, hemicellulose, and lignin. Sugarcane, sugar beet, rapeseed, safflower, miscanthus, jojoba, and switchgrass are some of the energy crops. Biofuel, biogas, biohydrogen, biodiesel, and ethanol from energy crops are considered renewable resources, which could be used as a substitute for conventional fuels.

Keywords: Energy crops, biomass, energy

INTRODUCTION

Lignocellulosic biomass includes harvested forest residues, short-rotation woods, agricultural residues, and energy crops. The elemental compositions of lignocellulose biomass are C, H, O, N, P, and S. The main elements C, H, and O mainly come from cellulose, hemicellulose, and lignin; N, P, and S mainly come from the minor components such as protein. The attractive natural fractional composition of the lignocellulose biomass has prompted researchers to the potential production of value-added materials development through different technological means and to use it in energy (Zhao et., 2015).

As one of the lignocellulosic biomass, energy crops are used in three core energy applications, which have potential: bioenergy (biomass energy), biofuels, and biorenewable materials. Currently, biomass energy, which has a large share in renewable energy sources, has an expanding production potential in fuel consumption for heat, electricity, and transportation. Bioenergy is an alternative energy to meet the increasing energy demand, provide safe energy production, provide affordable energy supply on a global scale while protecting the environment, and ensure local-regional-national-global development. Biodiesel and bioethanol, which are known as first-generation biofuels, dominate the biofuel transport sector today and are mainly produced from annual crops such as rapeseed and cereals. A shift toward second-generation biofuels, produced mainly from energy crops, is expected in the future. This change will have a significant impact on the industry as well as agriculture (Paschalidou et., 2018). The development of green, renewable, and highly efficient energy conversion methods as well as new energy storage technologies are in high demand. All the materials used in these devices are known to be key to fundamental advances



in energy conversion and storage. Therefore, high-performance materials must have certain properties. Furthermore, given the environmental issues and cost, the synthesis of these materials should be relatively simple and energy efficient and ideally based on natural, abundant, and renewable resources. Energy crops have the potential to serve as a sustainable resource for preparing biorenewable materials.

ENERGY CROPS AND THEIR USAGE AREAS

Energy crops are cultivated or self-sown kinds of crops which can be further used for various energy aims, like heat production, electrical power, and biofuels (Paschalidou et., 2018). The range of the respective process and supply chains for energy crops to energy and how herein the pathway to electricity is embedded is demonstrated in Figure 1. The conversion of biomass into solid, liquid, and/or gaseous secondary energy carriers can be realized via heat-induced processes, biochemical and/or physical-chemical processes. Thermochemical conversion can be divided into many steps and then carried out in various locations. Such conversion methods combine solid biomass with an oxidizing source at high temperatures and under controlled circumstances such as pressure, heating rate, and temperature, for the stoichiometric concentration required for complete oxidation. This makes it possible to transform the solid biofuel into secondary biofuels that can be utilized elsewhere and are solid, liquid, or gaseous (Mueller-Langer, F.et., 2019).

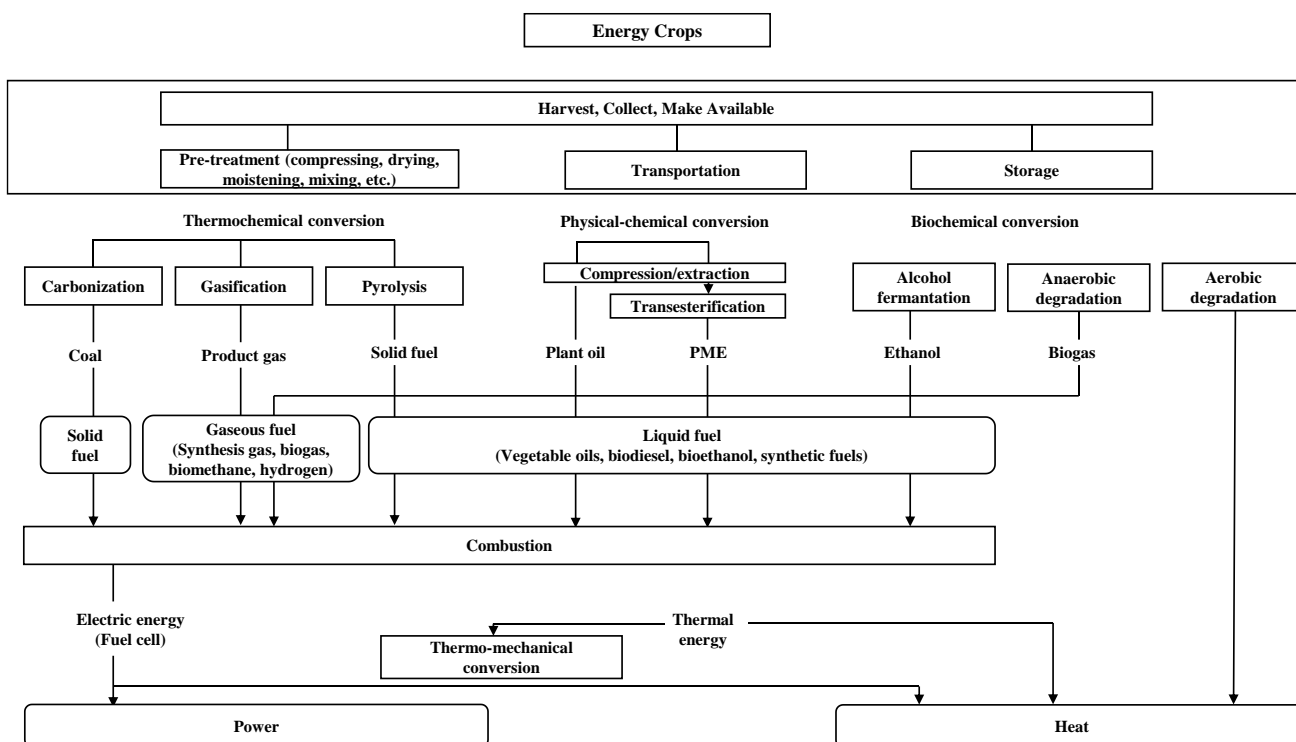

Figure 1. Energy crops to bioenergy



Biofuels can be subdivided into "bioethanol" (processed from sugar and grain crops) used to replace petroleum, and biodiesel (produced mainly from vegetable oils) used to replace diesel (Ramos et al., 2022). Bioethanol raw material is starch-sugar crops such as sorghum, sugar beet, and sugarcane. Bioethanol is produced by fermentation of saccharides formed by enzymatic hydrolysis (starch hydrolysis or delignification) of sugar and starch in my composition with biomass by means of microorganisms or by acidic hydrolysis from all types of cellulosic mass and then distillation of them. Biodiesel is produced by the reaction of oils obtained from oilseed plants such as rapeseed, sunflower, soybean, safflower with a short chain alcohol (methanol or ethanol) in the presence of a catalyst (Rodionova et al., 2021).

As seen in Figure 2 the article reports scanned to date in the energy field with the keywords "Switchgrass, Miscanthus, Jatropha, Jojoba, Sweet sorghum, Sugarcane, Sunflower, and Rapeseed" in Scopus are shown. The efficient development and clean use of energy crops has been an issue that concerns all countries in the world. However, energy crops have been explored for several years as an alternative feedstock for carbonization and, thanks to rapid, abundant biomass production, represent an important source of carbon. Its application area is increasing in various energy storage and conversion systems.

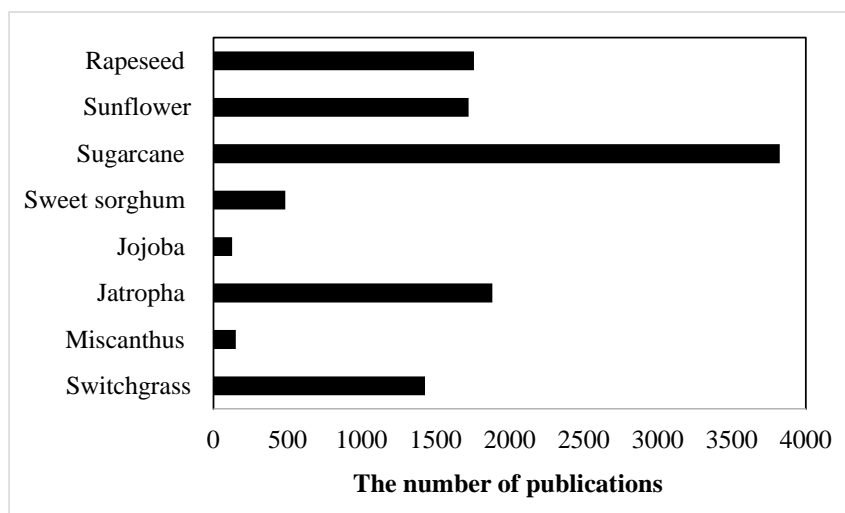

Figure 2. Research studies of different energy crops in the field of energy until today

Interest in biomass-derived carbon materials for energy storage and conversion systems is increasing day by day due to their high surface area, adjustable pore size, high electrical conductivity, and strong mechanical properties. Table 1 provides a brief summary of the effects of structural diversity, surface area, and surface heteroatom doping of biomass-derived carbon materials in various systems.

**Table 1.** Use of carbon materials obtained from various energy crops in energy storage and conversion systems

Energy crops	Energy storage/conversion	Carbon materials	Application area	Surface Area [m ² g ⁻¹]	Ref.
	Vanadium Redox Flow Batteries	Activated carbon	Positive catalyst electrode	1255	Mahanta et al., 2019
Sugarcane	Lithium-Ion Batteries Supercapacitor	N-doping activated carbon	Electrode	1939.9	Wang et al., 2018
	Supercapacitors	Porous carbon	Electrode	2400	Yadav and Hashmi, 2022
	Supercapacitors	Activated carbon	Electrode	1788	Konno et al., 2008
Rapeseed	Lithium-Sulfur Batteries	N-doped porous carbon	Electrode	2434.9	Rufford et al., 2010
<i>Miscanthus</i>	Microbial Fuel Cells	Activated carbon	Electrode	3027	Rethinasabapathy et al., 2020
<i>Switchgrass</i>	Supercapacitors	Activated carbon	Electrode	1373	Yumak et. al, 2020
Sugar Beet	Supercapacitors	Activated carbon	Electrode	950	Gür et al., 2022

DISCUSSION

Of the leading energy alternatives to fossil fuels, biomass is cost-effective and practical and therefore offers a sustainable strategy. It is versatile and can also be used to produce biomethane to replace natural gas, liquid biofuels to replace gasoline and diesel fuel, and as a source material for biochemicals and bioplastics. Overall, bioenergy is predicted to maintain its position as the highest contributor to global renewable energy in the short to medium term with energy crops set to provide a larger proportion of the biomass feedstock in the coming decades. A number of important considerations must be made while selecting the best energy crops, including the current conversion technologies, energy-type requirements, production environments, harvesting times, storage costs, and the overall preference for perennial, non-irrigated energy crops.

CONCLUSION

The term of "biorenewables" refers to the process of generating heat, power, transportation fuel, and other goods from formed organic matter. All of these include which is the sustainable coproduction of a variety of biobased goods such as food, feed, materials, chemicals, and energy (fuels, power, heat) from biomass. It becomes clear that biomass plays a significant role in the global energy system and is a technologically advanced energy carrier. Additionally, innovative conversion approaches promising higher efficiencies and a better environmental performance are currently being developed, and the resources for increased utilization are theoretically available. Therefore, it is reasonable to assume that biomass will continue to contribute more in the next years to meeting the predicted significantly rising energy demand.



ACKNOWLEDGEMENTS

One of the authors, Tuğba MEŞELİ and Hilal DOĞAN, would like to thank the Turkish Higher Education Institution YÖK (100/2000 Ph.D. Scholarship Program).

REFERENCES

- Gür, E., Semerci, T. G., & Semerci, F. 2022. Sugar beet pulp derived oxygen-rich porous carbons for supercapacitor applications. *Journal of Energy Storage*, 51, 104363.
- Konno, K., Ohba, Y., Onoe, K., & Yamaguchi, T. 2008. Preparation of activated carbon having the structure derived from biomass by alkali activation with NaOH, and its application for electric double-layer capacitor. *Tanso*, 2008(231), 2-7.
- Limayem, A., & Ricke, S. C. 2012. Lignocellulosic biomass for bioethanol production: current perspectives, potential issues and future prospects. *Progress in energy and combustion science*, 38(4), 449-467.
- Mahanta, V., Raja, M., & Kothandaraman, R. 2019. Activated carbon from sugarcane bagasse as a potential positive electrode catalyst for vanadium redox flow battery. *Materials Letters*, 247, 63-66.
- McKendry, P. 2002. Energy production from biomass (part 1): overview of biomass. *Bioresource technology*, 83(1), 37-46.
- Mueller-Langer, F., Majer, S., & Perimenis, A. 2019. Biofuels: A Technical, Economic, and Environmental Comparison. In *Energy from Organic Materials (Biomass)* (pp. 1175-1204).
- Paschalidou, A., Tsatiris, M., Kitikidou, K., & Papadopoulou, C. 2018. Using energy crops for biofuels or food: the choice. In *Using Energy Crops for Biofuels or Food: The Choice* (pp. 35-38).
- Rabemanolontsoa, H., & Saka, S. 2013. Comparative study on chemical composition of various biomass species. *RSC advances*, 3(12), 3946-3956.
- Ramos, A., Monteiro, E., & Rouboa, A. 2022. Biomass pre-treatment techniques for the production of biofuels using thermal conversion methods—A review. *Energy Conversion and Management*, 270, 116271.
- Rethinasabapathy, M., et al. 2020. Silver grass-derived activated carbon with coexisting micro-, meso-and macropores as excellent bioanodes for microbial colonization and power generation in sustainable microbial fuel cells. *Bioresource technology*, 300, 122646.
- Rodionova, M. V., et al. 2021. A comprehensive review on lignocellulosic biomass biorefinery for sustainable biofuel production. *International Journal of Hydrogen Energy*.
- Rufford, T. E., Hulicova-Jurcakova, D., Khosla, K., Zhu, Z., & Lu, G. Q. 2010. Microstructure and electrochemical double-layer capacitance of carbon electrodes prepared by zinc chloride activation of sugar cane bagasse. *Journal of Power Sources*, 195(3), 912-918
- Saini, J. K., Saini, R., & Tewari, L. 2015. Lignocellulosic agriculture wastes as biomass feedstocks



for second-generation bioethanol production: concepts and recent developments. *3 Biotech*, 5(4), 337-353.

Yadav, N., & Hashmi, S. A. 2022. High energy density solid-state supercapacitors based on porous carbon electrodes derived from pre-treated bio-waste precursor sugarcane bagasse. *Journal of Energy Storage*, 55, 105421.

Yumak, T., Yakaboylu, G. A., Oginni, O., Singh, K., Ciftiyurek, E., & Sabolsky, E. M. 2020. Comparison of the electrochemical properties of engineered switchgrass biomass-derived activated carbon-based EDLCs. *Colloids and Surfaces A: Physicochemical and Engineering Aspects*, 586, 124150.

Zhao, X., Liu, W., Deng, Y., & Zhu, J. Y. 2015. *Lignocellulosic biomass-energized fuel cells: cases of high-temperature conversion*. Momentum Press.

Wang, B., Wang, Y., Peng, Y., Wang, X., Wang, J., & Zhao, J. 2018. 3-dimensional interconnected framework of N-doped porous carbon based on sugarcane bagasse for application in supercapacitors and lithium ion batteries. *Journal of Power Sources*, 390, 186-196.

Xia, L., Song, Z., Zhou, L., Lin, D., & Zheng, Q. 2019. Nitrogen and oxygen dual-doped hierarchical porous carbon derived from rapeseed meal for high performance lithium-sulfur batteries. *Journal of Solid State Chemistry*, 270, 500-508.



A COMPUTATIONAL FLOW ANALYSIS THROUGH CATALYTIC CONVERTER FOR DIFFERENT GASES

Gamze GENÇ
Hüdayfa GÖK
Sevde ERTÜRK

Erciyes Üniversitesi Mühendislik Fakültesi Enerji Sistemleri Mühendisliği Bölümü, Kayseri,
TÜRKİYE

Abstract

A catalytic converter is an exhaust emission control device that converts toxic gases and pollutants in exhaust gas from an internal combustion engine into less-toxic pollutants by catalyzing a redox reaction. Catalytic converters are usually used with internal combustion engines fueled by gasoline or diesel, including lean-burn engines, and sometimes on kerosene heaters and stoves. The velocity distribution in the exhaust gas flow is a very important factor in determining the performance of the catalytic converter. Therefore, CFD analysis is used to investigate the operating conditions for efficient catalytic converters. In this paper, ANSYS FLUENT is used to model the flow of different gases through a catalytic converter to determine the pressure drop and the homogeneity of the flow. The simulations are performed under the incompressible flow conditions using the k- ϵ turbulence model. Nitrogen, Hydrogen and Oxygen having different atomic weights are considered as working fluids in the study. The results bring out that while the velocity loss is seen in lighter atomic weight gas flow as nitrogen is accepted when optimum gas, there is no loss in the heavier atomic weight gas flow.

Keywords: Catalytic converter, Computational Fluid Dynamics, Gas Flow

INTRODUCTION

A catalytic converter is a device used to reduce internal combustion engine emissions. The catalytic converter's purpose is to reduce the original harmful emissions to negligible levels by means of catalyst-controlled chemical reactions. Within the structure of the catalytic converter is a form utilizing a catalyst (Parmar and Keyur, 2014). The flow distribution in a catalytic converter assembly is governed by the geometry configurations of the inlet and outlet cone section, the substrate, and the exhaust gas compositions, so good design of the catalytic converter is crucial the efficiency, pressure drop, and performance of the catalytic converter may all be increased, decreased, and optimized with a smooth flow distribution. In this study, the Computational Fluid Dynamics (CFD) modelling approach of flow in a catalytic converter will learn with the help of flow visualization. Oh and Cavendish (1982) improved the technique to look into catalyst overheating issues in transient driving situations. Weltens et al. (1993) stated that performance improvements and longer service life of catalytic converters can be achieved by improving the flow distribution of the exhaust gases. Siemund et al. (1995) presented a two-dimensional model for the three-way catalytic converter. By comparing the simulation results with the experimental data obtained from the engine test bench, good result was obtained for less temperature development for conversion. The study proposes and fabricates a novel design for the catalytic converter inlet diffuser. The novel inlet diffuser comprises a few tube-to-tube cones that evenly disperse the flow at the monolith's entry face. Before and after the catalyst, the following parameters have been measured: temperature, pressure decrease, and pollutant concentration (Ghasemi and Mozafari, 2010). Hayes et al. (2012) confirmed by simulation



against experimental data obtained in the literature. The findings show that the monolith substrate design significantly affects the flow and temperature distributions as well as the chemical reactions that result. Venkateswarlu et al. (2020) methane conducted an emission reduction experiment in a catalytic converter using ethane. Different materials, including stainless steel wire mesh and ceramic stones, were used to test the experiment.

In this paper, ANSYS FLUENT is used to model the flow of different gases (Nitrogen, Hydrogen and Oxygen) through a catalytic converter to determine the pressure drop and the homogeneity of the flow.

MATERIALS AND METHODS

In experimental solutions, studies can be limited due to factors such as time and economy. Instead, by using the Computational Fluid Dynamics (CFD) method, both time and financial resources can be saved. By changing any desired variable with CFD analysis, the effect on the results can be made cheaper (compared to the experimental study). The aim of this study is to numerically examine the flow distributions of different types of fluids given a certain inlet velocity in catalytic converters. Nitrogen, Hydrogen and Oxygen having different atomic weights are considered as working fluids in the study.

Moreover, velocity changes in the flow area were investigated. Considering the effects, the most efficient entry and exit angles are suggested. Three-dimensional view of the considered converter is shown in Figure 1. The outlet pipe diameter is 4 cm, the catalytic converter body diameter is 10 cm, the body length is 20 cm, the inlet pipe diameter is 4 cm, and the inlet length is 10 cm. The working fluid is thought to be incompressible, the issue is three-dimensional, the flow is time-independent, the k-turbulence model is favoured for turbulent flow, and the inlet-outlet angles are assumed to be the same.

The assumptions for the flow inside the catalytic converter as following:

- The inlet velocity size is 22.6m/s,
- The density for turbulence is 5%,
- The hydraulic diameter is 40 mm by the specification method.

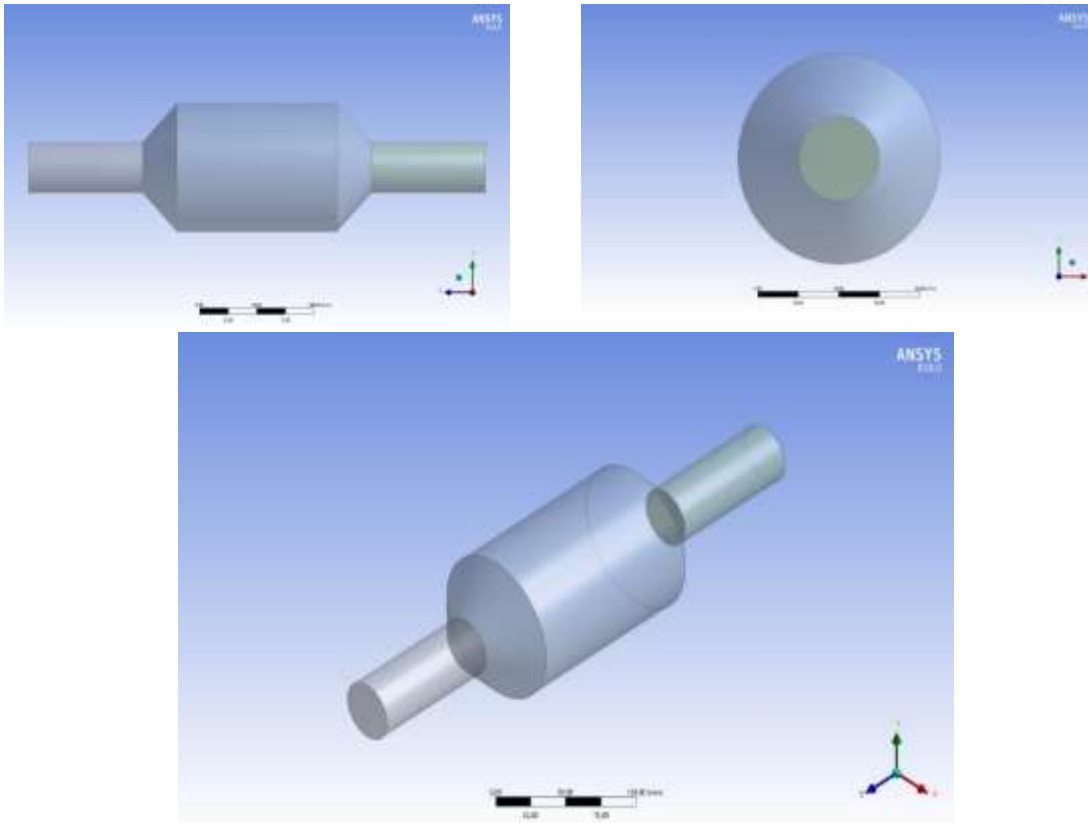

Figure 1. 3D View of Geometry

In the study, ANSYS FLUENT, which is a CFD application, was used. FLUENT program, which solves with the finite volume method, is also quite advanced in terms of solvent options. Continuity, momentum and turbulence (k- ϵ model) equations can be written with the general convection equation. Here ϕ is the general variable, Γ is the general diffusion coefficient, and S is the source term.

$$\frac{\partial(\rho\phi)}{\partial t} + \frac{\partial(\rho u\phi)}{\partial x} + \frac{\partial(\rho v\phi)}{\partial y} = \frac{\partial}{\partial x}\left(\Gamma \frac{\partial\phi}{\partial x}\right) + \frac{\partial}{\partial y}\left(\Gamma \frac{\partial\phi}{\partial r}\right) + S_{\phi} \quad (4)$$

The expressions corresponding to the general variable, diffusion term and source terms for the general transport equation are given in Table 1.



Table 1. General transport equation

Denklem	ϕ	Γ	S
Süreklilik	1	0	0
x - momentum	u	μ_{eff}	$-\frac{\partial P}{\partial x} + \frac{\partial}{\partial y}(\mu_{eff} \frac{\partial v}{\partial x}) + \frac{\partial}{\partial x}(\mu_{eff} \frac{\partial u}{\partial x})$
y - momentum	v	μ_{eff}	$-\frac{\partial P}{\partial y} + \frac{\partial}{\partial x}(\mu_{eff} \frac{\partial v}{\partial y}) + \frac{\partial}{\partial y}(\mu_{eff} \frac{\partial v}{\partial y})$
Türbülans kinetik enerjisi	k	$\frac{\mu_{eff}}{\sigma_k}$	$G_k - \rho \epsilon$
Türbülans kinetik enerjisi yutulma	ϵ	$\frac{\mu_{eff}}{\sigma_\epsilon}$	$\frac{\epsilon}{k}(C_1 G_k - C_2 \rho \epsilon)$

$$G_k = \mu_t \left[2 \left(\frac{\partial u}{\partial x} \right)^2 + 2 \left(\frac{\partial v}{\partial y} \right)^2 + \left(\frac{\partial u}{\partial y} + \frac{\partial v}{\partial x} \right)^2 \right]$$

$$\mu_{eff} = \mu + \mu_t \quad \mu_t = C_\mu \rho k^2 / \epsilon$$

$$\Gamma_1 = \frac{k}{C_\mu} + \frac{\mu_t}{Pr_t}$$

Pressure outlet is chosen as outlet boundary condition. The differential pressure measured by accepting atmospheric pressure as the outlet pressure is defined as “zero”. Boundary condition definition is made where there is no slip on the wall. A standard mesh is used. Mesh quality and image are given below.

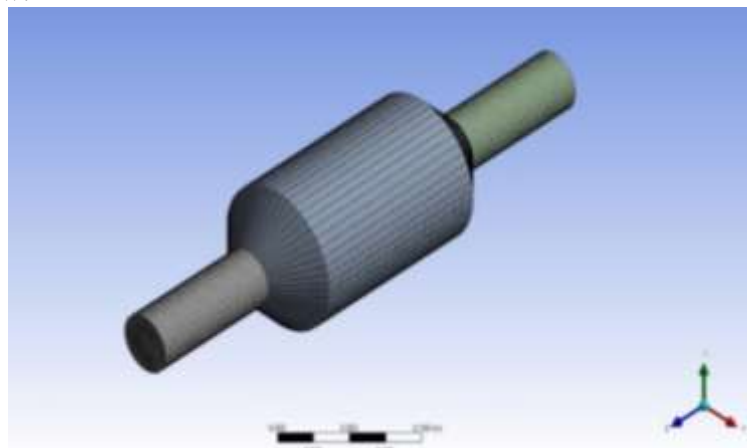
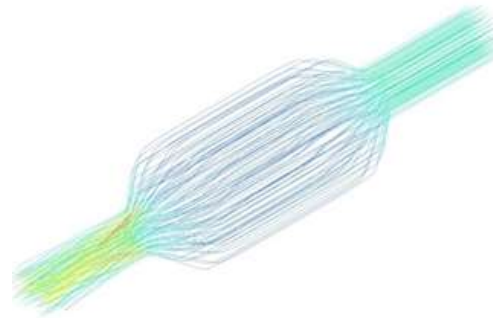
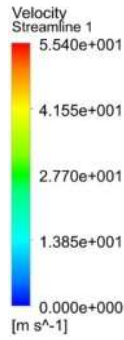

Figure 4. Mesh Structure

RESULTS AND DISCUSSION

In Figure 5, velocity distributions are shown with streamline. The red color on the color scales in the figures indicates high speed, and the blue color indicates low speed. It has been observed that while the inlet velocity of Nitrogen and Oxygen gases is almost the same, Hydrogen gas enters the converter faster. The same is true for output speeds.



a)N2

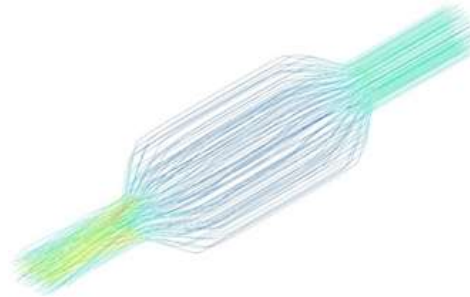
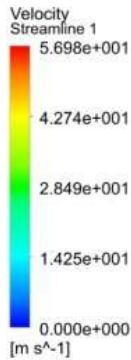

b)H2

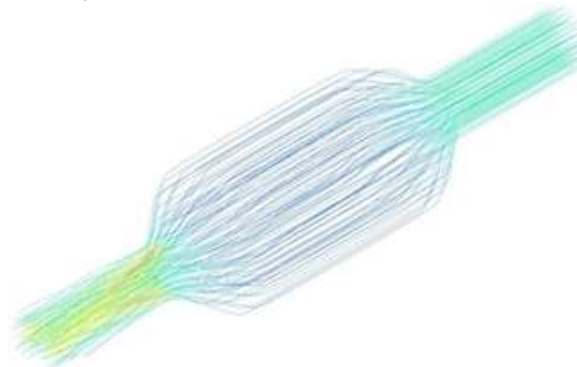
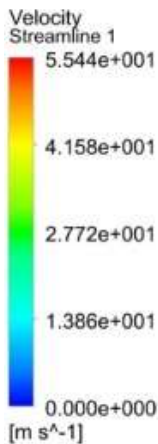

c)O2

Figure 5. Velocity distributions for different working fluids

CONCLUSION

As a result of the study, the effects of the use of different gases as fluids in the catalytic converter on the pressure difference and speed were investigated. Flow results are given with comparisons. After a series of iterations, the flow distribution appears to be uniform for a given inlet velocity of 22.6 m/s. In the three streams we discussed, different results were encountered according to the atomic weights. If we accept the Nitrogen as the zero point, since the Oxygen fluid is heavier than the Nitrogen, there is no loss of velocity, while there is a loss of velocity in the Hydrogen.



ACKNOWLEDGEMENTS

One of the authors, Sevde ERTÜRK, would like to thank the Turkish Higher Education Institution YÖK (100/2000 Ph.D. Scholarship Program).

REFERENCES

- Ghasemi A, Mozafari, AA 2010. *A New Approach for Inlet Diffuser of Automotive Catalytic Converter Considering Conversion Efficiency of Pollutants*.
- Hayes RE, Fadic A, Mmbaga J, Najafi A 2012. *CFD modelling of the automotive catalytic converter*. *Catalysis today*, 188(1), 94-105.
- Oh S H, Cavendish JC 1982. *Transients of monolithic catalytic converters. Response to step changes in feedstream temperature as related to controlling automobile emissions*. *Industrial & Engineering Chemistry Product Research and Development*, 21(1), 29-37.
- Parmar JM, Keyur P 2014. *Performance analysis of limestone coated wiremesh catalytic converter for emission control of CI engine*. *Int J Sci Res*, 1, 2377-2380.
- Siemund S, Schweich D, Leclerc JP, Villermaux J, 1995. *Modelling three-way monolithic catalytic converter: Comparison between simulation and experimental data*. In *Studies in Surface Science and Catalysis Vol. 96*, pp. 887-895.
- Weltens H, Bressler H, Terres F, Neumaier H, 1993. *Optimisation of Catalytic Converter Gas Flow Distribution by CFD Prediction*. SAE Technical Paper 930780.
- Venkateswarlu K, Kumar RA, Krishna R, Sreenivasan, M. 2020. *Modeling and fabrication of catalytic converter for emission reduction*. *Materials Today: Proceedings*, 33, 1093-1099.



YENİLENEBİLİR ENERJİ VE İŞSİZLİK ARASINDAKİ İLİŞKİ: ÜST GELİR GRUBU ÜLKELER ÖRNEĞİ

Ayşe Arı

Dr. Öğretim Üyesi, Mersin Üniversitesi, İktisadi ve İdari Bilimler Fakültesi, İktisat Bölümü, ORCID ID: 0000-0002-8485-5932

Özet

Literatürde yenilenebilir enerji tüketiminin istihdam üzerinde olumlu etkisinin olacağı ifade edilmektedir. Birçok ülke için önemli bir sorun olan işsizliğin azaltılmasına yenilenebilir enerjinin katkı sunması, yenilenebilir enerjinin önemini daha da artıracaktır. Bu çalışmanın amacı da yenilenebilir enerjinin istihdam üzerindeki etkisini araştırmaktır.

Çalışmada üst gelir grubu ülkeler ele alınmış ve 1998-2019 dönemi için panel sabit etkiler, rassal etkiler ve GMM yöntemleri ile analiz edilmiştir. Çalışmada işsizliği etkileyen diğer faktörlerden ekonomik büyüme, dışa açıklık ve finansal gelişme modele dahil edilmiştir. Analiz sonucunda yenilenebilir enerjinin işsizlik üzerindeki etkisinin negatif olduğu tespit edilmiştir. Böylece yenilenebilir enerji sektöründeki gelişmenin istihdamı artırıcı etkisi olacağı söylenebilir. Bu durumda gelişmekte olan ülkelerde işsizliğin önemli bir sorun olması ve yenilenebilir enerji sektörünün işsizliği azaltması, yöneticilerin yenilenebilir enerjiye yönelik teşviklerini artırması gerektiğine işaret etmektedir. Yöneticiler yenilenebilir enerji sektörünü teşvik edici politikalara başvurduğunda hem çevresel kaliteyi hem de istihdamı artırarak toplumun her iki açıdan kazançlı çıkmasını sağlayabilecektir. Modeldeki diğer açıklayıcı değişkenlerden ekonomik büyüme ve dışa açıklığın da işsizliği azaltıcı etki gösterdiği tespit edilmiştir. Bu durumda yöneticilerin ekonomik büyümeyi artırıcı politikalarının istihdam üzerinde olumlu yansımalarının olduğu görülmektedir. Benzer şekilde diğer ülkelerle yapılan ticaretteki artışın da istihdamı artırdığı belirlenmiştir.

Anahtar Kelimeler: Yenilenebilir enerji, işsizlik, gelişmekte olan ülkeler

Abstract

In literature it is stated that renewable energy consumption has a positive effect on employment. The contribution of renewable energy to the reduction of unemployment, which is an important concern for many countries, will further increase the importance of renewable energy. The aim of this study is to investigate the effect of renewable energy on employment.

In the study, we analyzed the upper middle income countries from 1998 to 2019 by employing panel fixed effects, random effects and GMM methods. In the study, we included economic growth, trade openness and financial development as being the other factors affecting unemployment. The results revealed that the effect of renewable energy on unemployment is negative. Thus, it can be said that the development of renewable energy sector will increase the employment rates. In this case, the fact that unemployment is an important problem in developing countries and the renewable energy sector contributes to the reduction of unemployment, indicates that authorities should increase incentives for renewable energy. If the authorities implement policies to encourage the renewable energy sector, they will also lead to higher environmental quality and employment, thereby enabling the society to win from both sides. The findings also showed that economic growth and trade openness have a reducing effect on unemployment. These findings indicate that when the authorities implement policies in order to accelerate economic growth it will also has positive effects on



employment. Similarly, it was determined that the increase in the trade size with other countries also increased employment.

Key words: Renewable energy, unemployment, developing countries

Giriş

Yenilenebilir enerji tüketiminin, çevre kalitesini artırmasından literatürde yoğun olarak bahsedilmektedir. Buna ilaveten yenilenebilir enerji, özellikle 1970'lerdeki enerji krizi sonrasında ön plana çıkan enerji güvenliği ve enerjide dışa bağımlılık sorunlarının giderilmesine de katkı sağlayacaktır(Kaya, 2022; Musa ve Maijama'a,2020).

Yenilenebilir enerjinin bir başka avantajının ise, istihdam üzerinde gerçekleşeceği ifade edilmektedir. Böylece yenilenebilir enerji ekonomik büyüme ve sürdürülebilir kalkınma için katkı sunacaktır (Oliveira vd., 2013).Yenilenebilir enerjinin istihdam artırıcı etkisi doğrudan ve dolaylı olarak gerçekleşebilecektir. Doğrudan etki, yenilenebilir enerji yatırım tesislerinde planlama, kurulum, bakım ve onarım gibi alanlarda istihdam edilen kişileri kapsamaktadır. Yenilenebilir enerji tüketiminin artması ile yenilenebilir enerji teknolojileri ve projelerinde istihdam edilen kişi sayısı artacaktır. Dolaylı etki ise, yenilenebilir enerji sektörüyle ilişkili diğer sektörlerdeki istihdam artışıyla ortaya çıkmaktadır. Yenilenebilir enerji tüketiminin artması ile birlikte bu sektöre girdi sağlayan sektörlerdeki üretim ve dolayısıyla istihdam artacaktır. İlaveten yenilenebilir enerji sektörüne yapılan harcama ve istihdam sebebiyle yaratılan gelir artışıyla diğer sektörlerde talep artışı ve üretim artışı yaşanacaktır. Bir başka deyişle, yenilenebilir enerji sektörünün sunduğu ek gelirin, çarpan etkisi yaratarak ekonomide ek gelir ve istihdam sağlaması söz konusu olabilecektir. Söz konusu bu etki uyarılmış etki olarak adlandırılmaktadır. Böylece yenilenebilir enerji sektörünün gelişmesi üretim ve ekonomik büyümeyi atıracaktır. Ekonomik büyüme ve yatırımlar ise çeşitli sektörlerde emek talebini artıracaktır (Yılancı vd., 2020; Saboori vd., 2022). Yenilenebilir enerji sektörüne yapılan büyük ölçekli yatırımlar, küçük ölçekli yatırımlardan daha fazla istihdam artıracaktır (Naqvi vd.,2022).

Öte yandan yenilenebilir enerji tüketimi istihdamın azalmasına da yol açabilecektir. Yenilenebilir enerji tüketiminin artması ile birlikte fosil yakıt tüketiminin düşmesi söz konusu olacaktır. Fosil yakıt talebinin azalması neticesinde, bu sektörde üretimin ve istihdam edilen kişi sayısının azalması beklenmektedir (Yılancı vd., 2020). Apergis ve Salim (2015:3), yenilenebilir enerjinin üretim maliyetlerinin istihdam üzerinde yaratması beklenen etkisinin belirsiz olduğuna dikkat çemiştir. Yenilenebilir enerji teknolojilerinin kurulum maliyetinin yüksek olması nedeniyle, sektörün desteklenmesi için finanse edilmesinde kullanılan fonlar, başka sektörlerde yapılacak yardımın azalması anlamına gelecektir. Bu durumda tüketicilerin ödeyeceği maliyet yükselecektir. Öte yandan, yenilenebilir enerji teknolojilerinin kurulum maliyetinin yüksek olmasına karşın üretim maliyetleri çok düşük olduğundan enerji fiyatlarının uzun dönemde düşmesi söz konusu olacaktır

Özetle yenilenebilir enerjinin işsizliği azaltması beklenmekle beraber net etki konusunda kesin bir şey söylenememektedir. Bu çalışmanın amacı yenilenebilir enerjinin işsizliğe olan etkisini üst gelir grubu ülkeler için araştırmaktır. Çalışmada panel sabit etki, rassal etki ve GMM yöntemleri kullanılmıştır.

1.Literatür İncelemesi

Literatürde yenilenebilir enerji ve istihdam arasındaki ilişkiyi inceleyen çalışmalarda genellikle teoriyle uyumlu olarak yenilenebilir enerjinin işsizliği azalttığı bulgusuna ulaşılmıştır. Ancak kullanılan yöntem, zaman aralığı ve ülke grubuna bağlı olarak elde edilen bulguların farklılık gösterebildiği tespit edilmiştir. Örneğin Naqvi vd.(2022), yenilenebilir enerjinin istihdam üzerindeki



etkisini Avrupa ülkeleri için analiz etmiştir. Çalışmada 1991- 2019 dönemi dikkate alınmış ve çeşitli panel tahmin yöntemleri kullanılmıştır. Elde edilen bulgularda yenilenebilir enerjinin işsizliği azalttığı görülmüştür. Bir başka çalışmada Khobai vd. (2020), Güney Afrika örneğine odaklanmış ve uzun dönemde yenilenebilir enerjinin işsizliği negatif etkilediğini tespit etmiştir. Ancak kısa dönemde istatistiksel olarak anlamlı bir ilişki tespit edememiştir. Yılancı vd. (2020) ise, yenilenebilir enerjinin işsizliğe etkisini OECD ülkeleri için araştırmıştır. Çalışma sonucunda yenilenebilir enerji tüketiminin Avusturya, Portekiz ve İspanya’da işsizliği pozitif etkilerken Avustralya, Şili, Fransa, Almanya ve Japonya’da negatif etkilediğini belirlemiştir. Hartley vd. (2015) ise ABD’deki yenilenebilir enerji çeşitlerinden rüzgâr enerjisi ve kaya gazının Teksas eyaletindeki istihdam üzerine etkisini ayrı ayrı ele almıştır. Yazar çalışmasında, panel genel momentler yöntemi ve panel birinci-farklar yöntemini kullanarak 2001-2011 dönemini sorgulamıştır. Elde edilen sonuçlarda kaya gazının istihdam artırıcı etkisi olurken rüzgar enerjisinin istihdam üzerinde anlamlı bir etkisinin olmadığı tespit edilmiştir. Avrupa Birliği ülkelerine odaklanan Markandya vd. (2016), Avrupa’nın büyük ölçüde fosil yakıttan yenilenebilir enerji ve gaz tüketimine yöneldiği 1995–2009 dönemini girdi çıktı modeli ile değerlendirmiştir. Çalışmada enerji sektöründe yaşanan dönüşüm sürecinde 2009 yılında AB bölgesinde yaklaşık 530,000 iş imkanı yaratıldığı tespit edilmiştir. Söz konusu iş imkanı AB ülkelerinde yaratılan istihdamın yaklaşık 0.24% unu kapsamıştır. İstihdamların üçte biri ise, AB içindeki sınır ötesi etkilerden yani başka bir ülkede meydana gelen değişiklikler nedeniyle ortaya çıkmıştır. Bu kapsamda istihdam açısından en çok kazançlı olan ülkeler Polonya, Almanya, Macaristan, İtalya ve İspanya olurken, en çok kaybedenler ise İrlanda, Litvanya, Fransa ve Çek Cumhuriyeti olmuştur. Yenilenebilir enerjinin istihdamı artırdığını tespit eden bir başka çalışmada Polat ve Kızılkın (2022), 37 OECD ülkesi için 2002-2014 dönemi için panel sabit ve rassal etki modelleri ile analiz etmiştir. Musa ve Maijama’a (2020) Nijerya örneğine odaklanmış ve 1991-2015 döneminde yenilenebilir enerji ile işsizlik arasındaki nedenselliği sorgulamıştır. Yazar Toda ve Yamamoto nedensellik testini kullandığı çalışması sonucunda değişkenler arasında çift yönlü ilişki tespit etmiştir. Çin örneğine odaklanan Cai vd. (2014) yenilenebilir enerji ve yeni enerji gelişimin işgücü piyasasına etkisini girdi- çıktı analizi çerçevesinde değerlendirmiştir. Yazar çalışmasında yenilenebilir enerji sektöründeki gelişimin işgücü talebi ve arzı arasında uyumsuzluğu artıracağına ve yapısal işsizliğe yol açacağına dair kanıtlara ulaşmıştır. Yazara göre yenilenebilir enerji sektörü 2011'den 2020'ye kadar yaklaşık 7 milyon istihdam artışı sağlayabilecek iken söz konusu uyumsuzluklar nedeniyle bunun yalnızca %81,8'i gerçekleştirilebilecektir. Bu durumda yazar yapısal işsizlik sorununu azaltmak ve yenilenebilir enerji sektörünün gelişimini daha da hızlandırmak için kadınlara daha iyi ve eşit bir eğitim verilmesi gerektiğinin belirtmiştir. İlaveten yenilenebilir enerji ile ilgili mesleki eğitimlere önem verilmesi gerektiğini tavsiye etmiştir.

Yenilenebilir enerjinin istihdamı olumsuz etkilediği bulgusuna ulaşan çalışmalardan Rafiq vd. (2018), 41 ülkeyi 1980-2014 dönemi için ele almış ve çeşitli panel veri yöntemleri kullanarak analiz gerçekleştirmiştir. Çalışma sonucunda yenilenebilir enerjinin istihdamı azalttığını tespit etmiştir. Benzer şekilde Ağpak ve Özçiçek (2018) yenilenebilir enerji tüketiminin istihdam üzerinde negatif etkisinin olduğunu tespit etmiştir. Yazar çalışmasında 59 ülkeyi 1991-2014 zaman aralığı için analiz etmiştir. Bir başka çalışmada Apergis ve Salim (2015), 80 ülkeyi panel eşbütünlük ve doğrusal olmayan nedensellik testleri ile analiz etmiş ve 1990–2013 dönemi için yenilenebilir enerjinin işsizlik üzerinde pozitif etkisi olduğunu tespit etmiştir. Ancak yazar aynı çalışmada elde edilen bulguların bölgelere göre farklılaştığını ifade etmiştir. Örneğin Asya ve Latin Amerika bölgesinden elde edilen sonuçlar yenilenebilir enerjinin işsizliği olumlu etkilediğini destekler niteliktedir. Yazara göre yenilenebilir enerjinin istihdam üzerindeki etkisi, yenilenebilir enerji teknolojilerinin kurulmasının maliyetine ve enerji etkinliğine bağlı olmaktadır. Zhao ve Luo (2017) ise yenilenebilir enerjinin çevre, istihdam ve düzenlemeler üzerindeki etkisini sorgulamış ve istihdamı attırmadığını Çin ekonomisi için yaptığı analizlerle gözlemlemiştir. Ancak aynı çalışmada istihdamdaki artışın yenilenebilir enerji sektörünün gelişmesini pozitif etkilediği tespit edilmiştir. Rivers (2013),



yenilenebilir elektrik enerjisine sağlanan desteklerin işsizliğe etkisini sektörel bazda ele almıştır. Çalışmada genel denge analizini tercih eden yazar iki ve üç faktörlü modeller sonucunda yenilenebilir enerji desteklerinin işsizliği artırdığını tespit etmiştir. Yazar çalışmada yenilenebilir enerji desteklerinin hangi koşullarda işsizliği azaltacağını da belirlemiştir. Bu koşullar şunlardır; a) sermaye ile emek arasındaki ikame esnekliği düşük olduğunda, b) sermayenin uluslararası hareketliliği olmadığında, c) yenilenebilir enerji sektörünün emek yoğunluğunun fosil yakıt sektörüne kıyasla yüksek olduğunda. Çalışmada Amerika için gerçekleştirilen analiz sonucunda elektrik sektöründen kaynaklı emisyonu 10% azaltacak kadar yapılan yenilenebilir enerji teşviklerinin işsizliği yaklaşık % 0.1–0.3 oranında artırdığı gözlenmiştir.

2. Model ve Veri

Bu çalışmada yenilenebilir enerjinin istihdam üzerindeki etkisi araştırılmıştır. Bu amaçla üst gelir grubu ülkelere odaklanılmış ve 28 ülke¹, 1998-2019 dönemi için analiz edilmiştir. Çalışmada mevcut literatür ve verilerin bulunabilirliği dikkate alınarak aşağıdaki model kullanılmıştır;

$$UNEMP_{it} = \theta_1 REN_{it} + \theta_2 GROW_{it} + \theta_3 TRADE_{it} + \theta_4 CRED_{it} + \theta_0 + e_{it} \quad (1)$$

Modelde bağımlı değişken olarak işsizlik oranı kullanılmıştır. Açıklayıcı değişkenlerden REN_{it} , yenilenebilir enerji tüketimini, $GROW_{it}$; ekonomik büyümeyi, $TRADE_{it}$; dışa açıklığı, $CRED_{it}$ ise; finansal gelişmeyi temsil etmektedir. Yenilenebilir enerji tüketimi olarak yenilenebilir enerji tüketiminin toplam enerji tüketimi içerisindeki oranı kullanılmıştır. Ekonomik büyümeyi temsilen, reel kişi başı GSYİH verileri tercih edilmiştir. Dışa açıklık olarak ise ihracat ve ithalat toplamının GSYİH'ya oranı kullanılırken finansal gelişme için özel sektöre verilen krediler modelde yer almıştır. Değişkenlerin logaritmik değerleri modelde kullanılmıştır. Veriler Dünya Bankası veri tabanından temin edilmiştir.

Çalışmada panel sabit etki modeli kullanılmıştır. Ayrıca karşılaştırma yapabilmek amacıyla panel rassal etki ve dinamik panel veri modellerine de yer verilmiştir.

3. Ampirik Bulgular

Çalışmada öncelikle serilerin durağan olup olmadıkları analiz edilmiştir. Bunun için Levin, Lin ve Chu testi kullanılmış ve elde edilen sonuçlarda olasılık değerleri 0.05'ten küçük olduğundan serinin birim kök içerdiğini ifade eden temel hipotez reddedilmiştir. Böylece serilerin düzeyde durağan olduğu belirlenmiştir. Daha sonra uygun modelin belirlenmesi için çeşitli testlere başvurulmuştur. Bu çerçevede Tablo 4'te yer alan F testi, Breusch ve Pagan LM testi ile Hausman testi sonuçları, sabit etkili modelin uygun olduğuna işaret etmiştir. F testinde, değişkenler için birim ve zaman etkinin olmadığını ifade eden temel hipoteze karşı sabit etkiler modeli sınanmaktadır. Elde edilen sonuçlarda Havuzlanmış EKK'yı temsil eden temel hipotez reddedilmekte ve sabit etkiler modelinin uygun olduğu anlaşılmaktadır. Breusch ve Pagan LM testi sonuçlarında ise, Havuzlanmış EKK'ya karşı rassal etki modelinin geçerli olduğu ortaya konulmaktadır. Hausman testinde ise, açıklayıcı değişkenler ile birimler arasında korelasyonun olmadığını (rassal etki) yansıtan temel hipotez sınanmaktadır. Bu test sonucunda rassal etki ve sabit etki modelinden sabit etki modelinin tercih edilmesi gerektiği ortaya çıkmıştır.

¹ Albania, Armenia, Azerbaijan, Belarus, Belize, Bosnia and Herzegovina, Gabon, Dominican Republic, Jamaica, Jordon, Kazakhstan, Malaysia, Mairitus, Mexico, Moldova, Paraguay, Peru, South Africa, Thailand, Tonga, Türkiye



Tablo 1. Birim Kök Test Sonuçları

	Levin, Lin ve Chu (2002) (intercept)	
	istatistik	Olas.
UNEMP	-4.40368	0.000
REN	-4.52226	0.0000
GROW	-5.65889	0.0000
CRED	-3.27814	0.0005
TRADE	-2.78090	0.0027

Tablo 2’de ise sabitli ve rassal etki modelleri için birim ve zaman etkilerinin varlığı sorgulanmış ve modelin hem zaman hem de birim etkileri içerdiği görülmüştür. Böylece 2-way modelin uygulanması gerektiği tespit edilmiştir. Diğer taraftan Tablo 3’te sabit etki ve rassal etki modellerine ilişkin otokorelasyon ve değişenvaryans test sonuçları özetlenmiş ve ulaşılan bulgular modelin değişenvaryans ve otokorelasyon sorunu olduğu yönündedir. Bu nedenle 2 yönlü sabit etki ve rassal etki modelleri robust tahmincilerle tahmin edilmiştir.

Tablo 2. Birim ve zaman etkiler

Test	Sabit etkiler		Test	Rassal etkiler	
	istatistik	p-value		istatistik	p-value
F-group_fixed	196.9054	0.000000	LM-group_random	4918.421	0.000000
F-time_fixed	1.649389	0.034698	LM-time_random	9.673219	0.001870
F-two_fixed	111.1198	0.000000	LM-two_random	4928.094	0.000000
			Honda-two_random	47.39120	0.000000

Sabit etki ve rassal etki modellerinden elde edilen sonuçlar ise Tablo 4’te özetlenmiştir. Burada rassal etki ve sabit etki model sonuçlarının uyumlu olduğu görülmektedir. Tablo 4’teki sonuçlara göre, yenilenebilir enerji, işsizliği negatif etkilemektedir. Böylece yenilenebilir enerji sektöründeki gelişmenin istihdamı dolaylı ya da doğrudan artırıcı etkisi olacağı ortaya çıkmaktadır. Elde edilen bu sonuçlar literatürdeki çalışmalardan Khobai vd. (2020), Garrett (2017), Polat ve Kızılkın (2022) ile Markandya vd. (2016) çalışmalarıyla örtüştüğü söylenebilir.

Tablo 3. Otokorelasyon ve değişenvaryans test sonuçları

Sabit Etkiler			Rassal Etkiler		
Otokorelasyon Testi			Otokorelasyon Testi		
Tests	istatistik	p-value	Tests	istatistik	p-value
LMp-stat	374.5235	0.0000	LMmurho-stat	4921.495	0.0000
Durbin-Watson	0.313042		LMmu rho-stat	4542.275	0.0000
Değişen varyans testi			Değişen varyans testi		
LMh_fixed	374.7050	0.0000	LMh_random	634.2776	0.0000

Tablo 4’teki sonuçlara göre modeldeki diğer açıklayıcı değişkenlerden ekonomik büyüme ve dışa açıklık da işsizliği azaltıcı etki göstermektedir. Böylece istihdam yaratan bir büyümeden bahsedilebilir. İlavenen, ticari açıklığın işsizliği negatif etkilemesi, diğer ülkelerle yapılan ticaret



hacmindeki artışın, istihdamı artıracığını ifade etmektedir. Öte yandan çalışmada finansal gelişmenin ise işsizliği olumsuz etkilediği görülmüştür.

Table 4. Sabit Etki, Rassal Etki ve GMM Modeli Sonuçları

değişkenler	Sabit etki		Rassal etki		GMM	
	katsayı	prob	katsayı	prob	katsayı	prob
TRADE	-0.179201	0.0015	-0.213384	0.0034	-0.32146	0.0005
RENEW	-0.148298	0.0003	-0.108944	0.0018	-0.12091	0.0090
GDPP	-0.385115	0.0000	-0.492133	0.0000	-0.15361	0.0660
CRED	0.125616	0.0009	0.084141	0.0333	0.03397	0.4567
UNEMP(-1)					0.78385	0.0000
F testi 188.42 (0.000)		Breusch ve Pagan LM testi 4754.37(0.0000)		Sargan testi 21.9271(0.52465)		
Hausman testi 48.3108(0.000)		AR(2) 0.2618(0.7934)		AR(1) -1.9944(0.046)		

Çalışmada sabit ve rassal etki modellerine ilaveten elde edilen bulguların sağlamlığını ortaya koymak amacıyla dinamik panel veri yöntemine de başvurulmuştur. Bu kapsamda Arellano ve Bond(1991)'un GMM yöntemi kullanılmıştır. GMM yönteminde bağımlı değişken olan işsizliğin gecikmeli değeri de açıklayıcı değişken olarak yer almakta olup istatistiksel olarak anlamlı ve pozitifdir. Modelin geçerliliğini sınavan testlerden Sargan testi sonuçları kullanılan araç değişkenlerin geçerli olduğunu ifade etmektedir. AR(1) ve AR(2) test sonuçları ise modelde 1. ve 2. dereceden otokorelasyon sorunu olmadığı yönündedir. Açıklayıcı değişkenlerin işsizlik üzerindeki etkilerine bakıldığında ise GMM tahmin sonuçlarında da ekonomik büyüme, yenilenebilir enerji ve ticari açıklığın işsizliği negatif etkilediği tespit edilmiştir. Böylece GMM yönteminden elde edilen sonuçların rassal etkiler ve sabit etkiler modelinin bulgularıyla örtüştüğü görülmektedir. Finansal sektörün ise işsizlik üzerindeki anlamlı bir etkiye sahip olmadığı belirlenmiştir.

Sonuç

İstihdam ve yenilenebilir enerji, gelişmekte olan ülkelerin ilerleme kaydetmek istediği önemli konular arasındadır. Bu çalışmada yenilenebilir enerji-işsizlik ilişkisi üst gelir grubu ülkeler için araştırılmıştır. Bu amaçla 28 ülke, 1998-2019 dönemi verileri kullanılarak panel veri modelleri ile analiz edilmiştir.

Çalışmada sabit etkiler, rassal etkiler ve GMM yöntemlerine başvurulmuştur. Her üç yöntemden elde edilen sonuçlar birbiriyle aynı doğrultudadır. Söz konusu bulgularda yenilenebilir enerjinin teoride beklenildiği gibi işsizliği azalttığı belirlenmiştir. Bu durumda çevre kalitesini artırmak isteyen yöneticiler yenilenebilir enerji sektörünü teşvik edici politikalara başvurduğunda, bu politikaların istihdama da olumlu yansımaları beklenecektir. Benzer şekilde ekonomik büyüme ve dış ticaret hacminin de işsizliği negatif etkilediği bulgusuna ulaşılmıştır. Bu nedenle ekonomik büyümeye önem veren ve bu yönde politikalar uygulayan gelişmekte olan ülkelerin istihdamda artış sağlaması mümkün olabilecektir. Ülkelerin diğer ülkelerle gerçekleştirilen ticaret hacminin büyümesine bağlı olarak da istihdam artışı beklenebilecektir. Finansal gelişmenin ise yöntemlere göre farklılaşan etki gösterdiği tespit edilmiştir. Özetle işsizliğin azalması için yöneticilerin ekonomik büyümeyi hızlandıran, yenilenebilir enerji sektörünü geliştiren ve ihracatı artıran politikaları teşvik etmesi gerektiği söylenebilir.



Kaynakça

- Ağpak, F., Özçiçek, Ö.(2018). Bir İstihdam Politikası Aracı Olarak Yenilenebilir Enerji. *Ömer Halisdemir Üniversitesi İktisadi ve İdari Bilimler Fakültesi Dergisi*, 11(2), 112-128.
- Apergis, N., Salim, R. (2015). Renewable energy consumption and unemployment: evidence from a sample of 80 countries and nonlinear estimates. *Applied economics*, 47(52), 5614-5633.
- Cai, W., Mu, Y., Wang C., Chen, J. (2014). Distributional employment impacts of renewable and new energy—A case study of China. *Renewable and Sustainable Energy Reviews*, 39, 1155-1163.
- Hartley, P.R., Kenneth, B., Temzelides, T., Zhang, X. (2015). Local employment impact from competing energy sources: Shale gas versus wind generation in Texas. *Energy Economics*, 49, 610-619
- Kaya, H. (2022). Renewable Energy Investments and Unemployment Problem. In: Dinçer, H., Yüksel, S. (eds) *Circular Economy and the Energy Market. Contributions to Economics*. Springer, Cham. https://doi.org/10.1007/978-3-031-13146-2_18
- Khobai, H., Kolisi, N., Moyo, C., Anyikwa, I., Dingela, S. (2020). Renewable Energy Consumption and Unemployment in South Africa. *International Journal of Energy Economics and Policy*, 10(2), 170-178.
- Levin, A., Lin C.F., Chu C.S.J. (2002). Asymptotic and finitesample properties. *Journal of Econometrics*: 108, 1-24.
- Markandya, A., Arto, I., González-Eguino, M., Román, M. V. (2016). Towards a green energy economy? Tracking the employment effects of low-carbon technologies in the European Union. *Applied energy*, 179, 1342-1350.
- Musa, K.S., Maijama'a, R.(2020). Causal Relationship Between Renewable Energy Consumption And Unemployment In Nigeria: Evidence fom Toda and Yamamoto Causality Technique. *Energy Economics Letters*, 7(1), 46-60.
- Naqvi,S., Wang, J., Ali, R. (2022). Towards a green economy in Europe: does renewable energy production has asymmetric effects on unemployment?. *Environmental Science and Pollution Research*, 29, 18832–18839.
- Oliveira, C., Coelho, D., da Silva, P., Antunes, C.H. (2013). How many jobs can the RES-E sectors generate in the Portuguese context?. *Renewable and Sustainable Energy Reviews*, 21, 444-455.
- Polat, B., Kızıllkan, Ö. (2022). Yenilenebilir Enerji Tüketiminin İşsizlik Üzerindeki Etkisi: OECD Ülkeleri İçin Örnek Bir Çalışma. *İşletme Araştırmaları Dergisi*, 14 (3), 1983-1992.
- Rafiq, S., Salim, R., Sgro, P.M. (2018). Energy, unemployment and trade, *Applied Economics*, 50(47),5122-5134.
- Rivers, N. (2013). Renewable energy and unemployment: A general equilibrium analysis. *Resource and Energy Economics Journal*, 35, 467-485.
- Saboori, B., Gholipour, H.F., Rasoulinezhad, E., Ranjbar, O. (2022). Renewable energy sources and unemployment rate: Evidence from the US states. *Energy Policy*, 168, 113155.
- Yılancı, V. , İslamoğlu, E., Yıldırım, S., Candan, G. (2020). The Relationship between Unemployment Rates and Renewable Energy Consumption: Evidence from Fourier ADL Cointegration Test. *The Journal of Operations Research, Statistics, Econometrics and Management Information Systems*, 8(1), 17-28.



INTERNATIONAL ASIAN CONGRESS ON CONTEMPORARY SCIENCES – VII

Zhao, X., Luo, D. (2017). Driving force of rising renewable energy in China: Environment, regulation and employment. *Renewable and Sustainable Energy Reviews*, 68, 48-56.



**DEPENDING ON INDUSTRIAL DENSITY INVESTIGATION OF POSSIBLE GROUND
WATER QUALITY CHANGE**

İbrahim Fedâ ARAL

Ali Rıza DİNÇER

Department of Civil Engineering, Çorlu Faculty of Engineering, Tekirdağ Namık Kemal University, Tekirdağ, Turkey

ORCID:0000-0002-9294-0643

Department of Environmental Engineering, Çorlu Faculty of Engineering, Tekirdağ Namık Kemal University, Tekirdağ, Turkey

ORCID:0000-0002-9294-0643

Abstract

In order to understand the factors affecting the formation of inorganic pollutants in groundwater, firstly, the distribution of selected pollutants based on the results obtained from the wells in line with the Turkish Standards TS266 and other international drinking water standards limit values regulation was examined. As, Al, Na, Se, Cl, Fe and Mn parameters were investigated in these wells.

Between 2015 and 2020, physico-chemical components of a total of 16 groundwater wells from 4 sites were evaluated during the rainy and dry seasons. It was found that the arsenic concentration was low in the K13-K16 wells far from the industry, and 10µg/L and 13µg/L in the K11 and K13 wells according to the upper limit value of TS266. The aluminum concentration exceeds the upper limit values with 138.8µg/L in the K7 well. Selenium concentration in all wells is below the upper limit value (<10 µg/L). The low sodium and chloride concentrations indicate that there is no salinization in the wells. Fe concentrations in wells K7 and K10 were found to be 327.3 and 230.8 µg/L, respectively. The manganese concentration exceeds the upper limit value (50 µg/L) in wells K3, K10 and K13.

Considering the locations of all wells, residential areas and industrial location, the industrial location and pollution relationship could not be determined. This shows that the well waters are not contaminated with agricultural and domestic wastewater.

Keywords: Heavy metals, Groundwater, organic pollution

1.INTRODUCTION

Groundwater pollution is a growing concern in our region, as all of our domestic potable water comes from well water. Groundwater pollution causes occur from both point sources and non-point sources. Since the fluidity of groundwater is slow, pollutants move slowly throughout the aquifer and spread of pollutants is slow. The toxic chemical composition of organic and inorganic substances in groundwater creates harmful effects on human health. It is difficult to estimate the extent of contamination in the region and in different basins, as the spread of pollutants and the pollutant parameters are very variable. Contaminated aquifers are difficult, expensive and generally not feasible to clean up.



Groundwater is the water below the soil surface that forms all or part of the existing voids in the ground. Groundwater is water from rain or river water or from melting ice that seeps into the soil and forms a layer of groundwater. There are two types of groundwater: near the surface and far from the surface. Groundwater is one of the most important sources of liquid freshwater, despite the distance of some of its layers from ground level (Al Taai, 2021). Groundwater moves in the direction of the surface slope and discharges into streams, rivers, lakes and oceans. However, this flow may sometimes not coincide with the surface water flow (Al Taai, 2021).

Major anthropogenic components in surface and groundwater include K^+ , Na^+ , SO_4^{2-} , along with Cl^- and NO_3^- , which are the main contributors to groundwater pollution in Guiyang and surrounding areas (Lang et al., 2006). Groundwater contains both arsenite and arsenate (Chatterjee et al., 1993). Nitrate (NO_3^-) is the most common pollutant found in shallow aquifers due to both point and non-point sources (Postma et al., 1991). Many studies conducted in the USA have shown that the main source of high nitrate concentrations in groundwater is agricultural activities (Harter et al., 2002; Almasri et al., 2004). Agricultural practices can cause non-point source pollution of groundwater (Hall et al., 2001; Delgado et al., 2002). The most problematic inorganic agricultural chemicals are nutrients (NO_3^- -N, P-top, SO_4) and heavy metals (Zn, Cu, Ni) (Rozemeijer et al., 2007). In the US, pesticides as a non-point source of pollution have been detected in an estimated 16% of rivers and 20% of lakes in the 40 states studied, as well as one or more of 46 pesticides in the groundwater of 26 states (Archer et al., 2001). Domestic wastewater is the main source of various pollutants, including pathogenic microbes, nutrients, toxic metals and organic compounds (Abdalla et al., 2018). Human fecal material consists of a substantial proportion of bacteria and contains approximately 3×10^7 coliform bacteria/100 mL; these microorganisms vary according to the way they move through the soil (DeBorde et al., 1998).

Parameters such as pH, electrical conductivity, chloride, nitrate, sulfate, sodium, calcium, magnesium, organochlorine, organophosphorus, herbicide, fungicide, carbamate, organochlorine, PAH, VOC and trihalomethanes were used in the evaluation of groundwater pollution to monitor the current state of groundwater quality.

2. MATERIAL AND METHOD

Samples were collected as part of the sampling process. Samples were taken to evaluate organic and inorganic pollution in industrial remote areas and near industrial areas. Water samples were collected at varying depths in these wells. The samples were analyzed by the Istanbul Public Health Directorate Public Health Laboratory No. 2. EPA 200.8/ICP-MS (Antimone, As, B, Cd, Cr, Cu, Pb, Hg, Ni, Se, Al, Fe, Mn, Na), TS9748EN27888/CONDUCTIMETRIC (Conductivity) devices were used by the Public Health Laboratory in the measurements.

3. CONCLUSIONS AND DISCUSSION

The concentration changes of organic and inorganic pollutants measured in 16 wells at four different sites were investigated. Each parameter is given graphically depending on the location of the well, and the results are examined.



3.1. Arsenic concentration variation depending on the well location

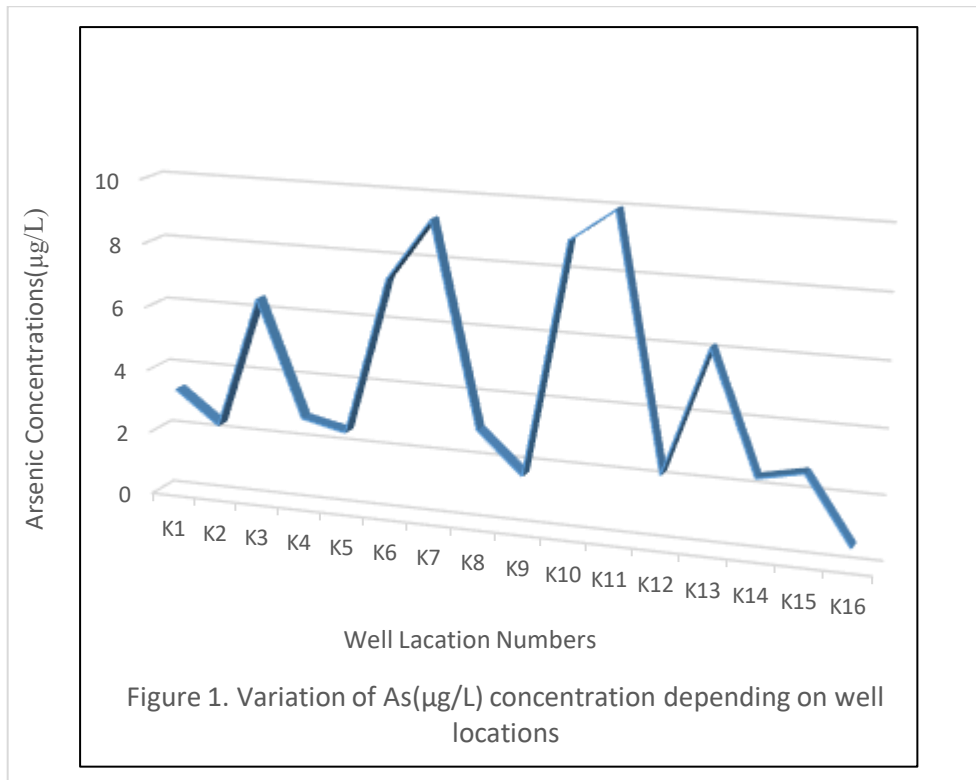

K1-K9 are wells close to industrial areas. K10-K13 refers to the wells located in the villages and K14-K16 refers to the wells in the region far from industry. The highest As concentrations were measured in wells K3, K6, K7, K10, K11, K13, 6.44 µg/L, 7.4 µg/L, 9.3 µg/L, 9.0 µg/L, 10 µg/L, 13 µg/L, respectively. . When the industrial zones and well locations were examined, a linear relationship could not be determined between the As concentration and the industrial settlements. The highest As concentration was found in the K11 well, 10 µg/L. There is a sewage sludge storage area in the upper part of this well. In the current TS266 standards, the upper limit of As is 10 µg/L. The limit value is not exceeded in any well location. Arsenic concentration is a problem that generally occurs in areas where fossil fuels are present.



3.2. Aluminum concentration variation depending on the well location

K1-K9 are wells close to industrial and residential areas. K10-K13 refers to the wells located in the villages and K14-K16 refers to the wells near the city center in the region far from the industry.

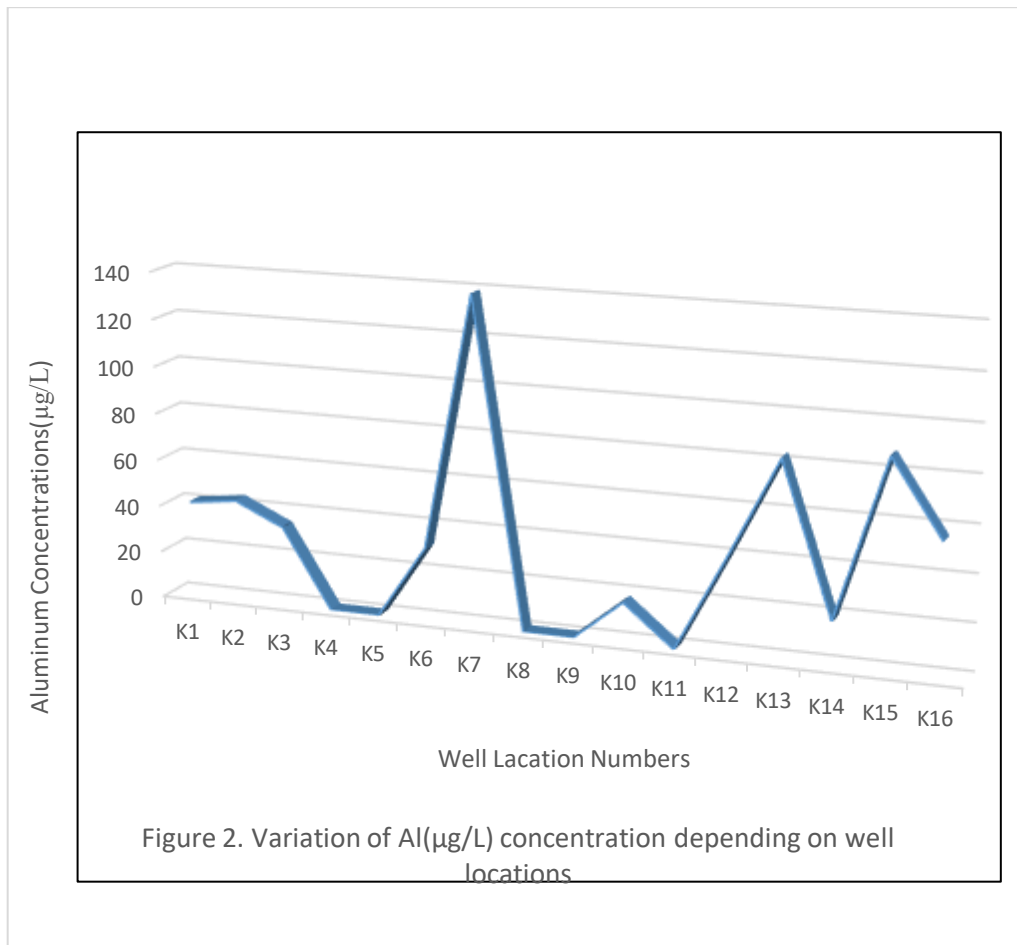

As seen in Figure 2, Aluminum concentrations differ depending on the location of the well. Aluminum concentrations were found to be minimum in wells K4-K5 and K8-K11. The highest Aluminum concentrations were determined as $K7 > K15 > K13 > K16 > K2 > K1$, respectively. Aluminum concentrations in wells K7, K15, K13, K16, K2 and K1 were measured as 138.8 µg/L, 87.4 µg/L, 82.73 µg/L, 55.6 µg/L, 43.4 µg/L and 40.82 µg/L, respectively. According to TS266, Aluminum upper limit concentration is 200 µg/L. According to the World Health Organization WHO2011, the limit value is 100 µg/L. Limit values are not exceeded in any well. The highest Aluminum concentration was detected in the K7 well in the city close to the industrial zone. The K7 well exceeds the World Health Organization upper limit value by 39%. The K15 and K13 wells, where high aluminum concentrations are measured, are far from the industrial settlements. The high concentrations are thought to be due to possible solid waste contamination. Considering the well locations and industrial settlements in the graph, no linear relationship could be found regarding industry and Aluminum pollution. When Figure 1 and Figure 2 are compared, the values of the K7 well were found to be high in both graphs.



3.3. Variation of Sodium (Na) Concentration Depending on Well Location

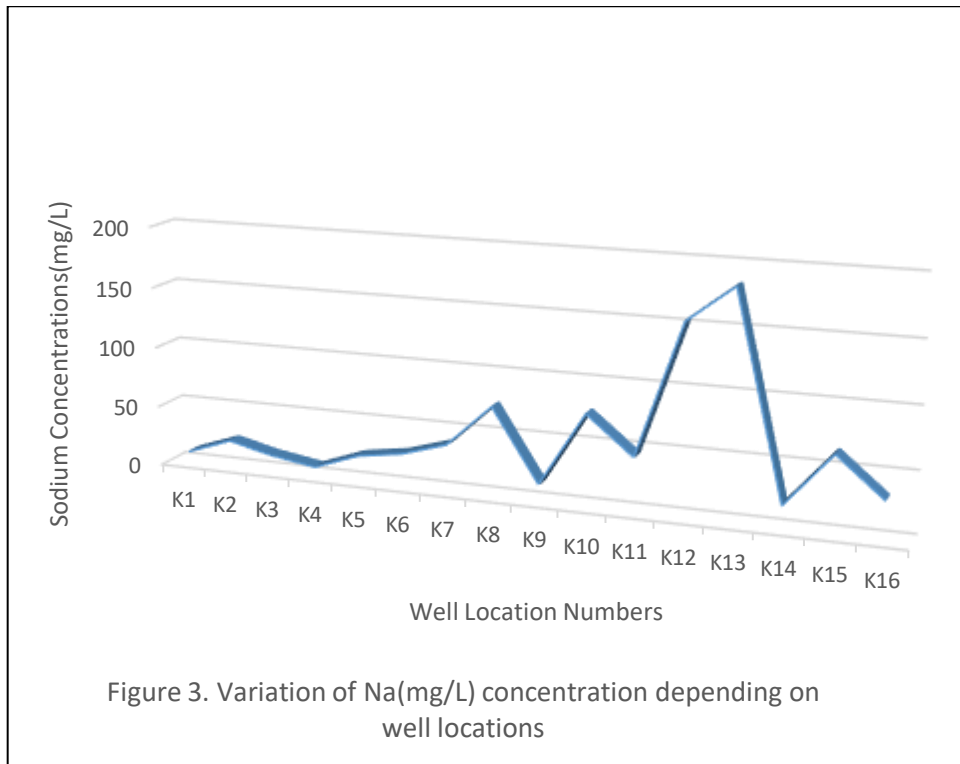

K1-K9 are wells close to industrial and residential areas. K10-K13 refers to the wells located in the villages and K14-K16 refers to the wells near the city center in the region far from the industry. Sodium concentration is used as an indicator of salinization in that region. Sodium concentration does not exceed TS266 water quality limit values. As seen in Fig.1, Fig.2 graphics, the concentration was found to be high in well K13 in Fig.3. Well K13 is a well located in an area far from industry. High sodium concentration was not associated with any pollutant source. The highest sodium concentrations were found in wells K13, K12 and K15. The sodium concentrations in wells K13 and K12 are 183.92 mg/L and 154.7 mg/L, respectively. K1-K9 wells are close to industrial and residential areas. Sodium concentration was found to be minimum at these points. Despite the intense use of salt (NaCl) in textile factories in the region, the sodium concentration in the wells in this region was low.



3.4. Variation of Selenium(Se) Concentration Depending on Well Location

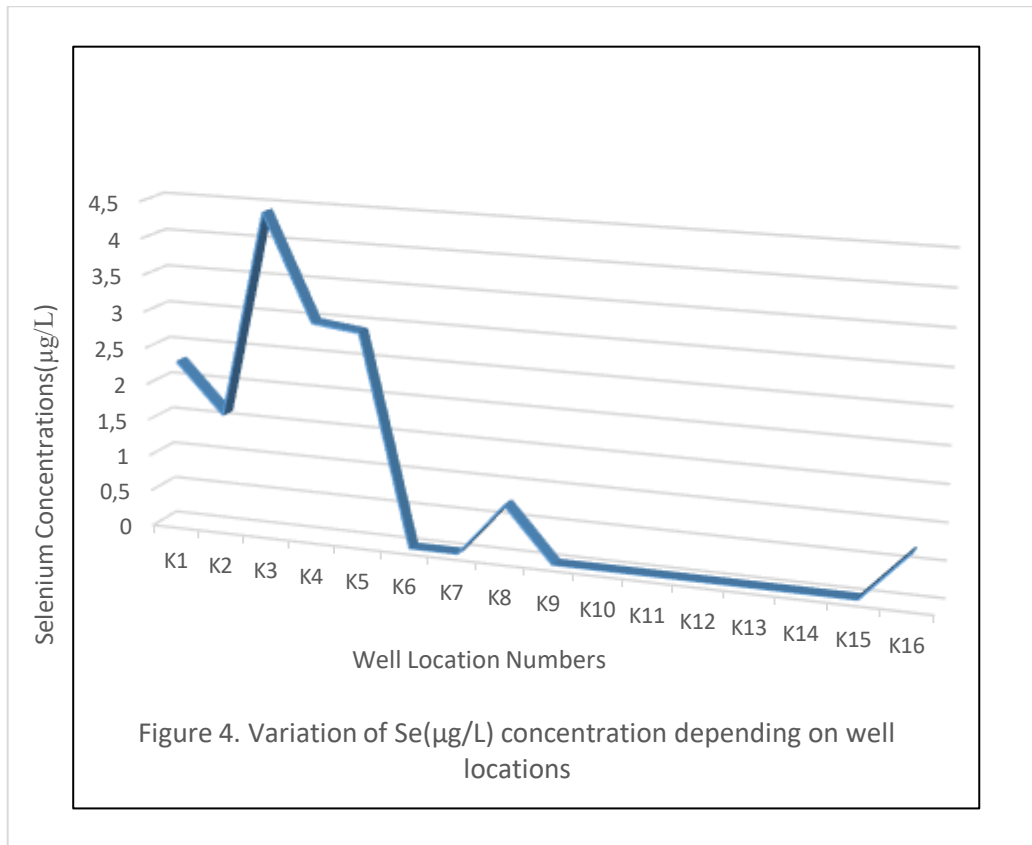

As seen in Figure 4, Selenium concentrations were found below the TS266 and WHO standard limits (10 µg/L). Selenium concentrations were found to be high in K1-K5 jugulars. Selenium concentrations in wells K1, K2, K3, K4 and K5 were measured as 2.29 µg/L, 1.6 µg/L, 4.42 µg/L, 2.98 µg/L and 2.9 µg/L, respectively. K1-K5 wells are close to industrial and residential centers. When the K6-K16 well locations were examined, no relationship was found between the selenium concentration and industry and settlement. It is thought that the selenium concentration is due to the rock and soil structure where the existing wells are located. Selenium excess is known to damage liver and heart tissues.



3.5. Change in Chloride (Cl) concentration depending on the well location

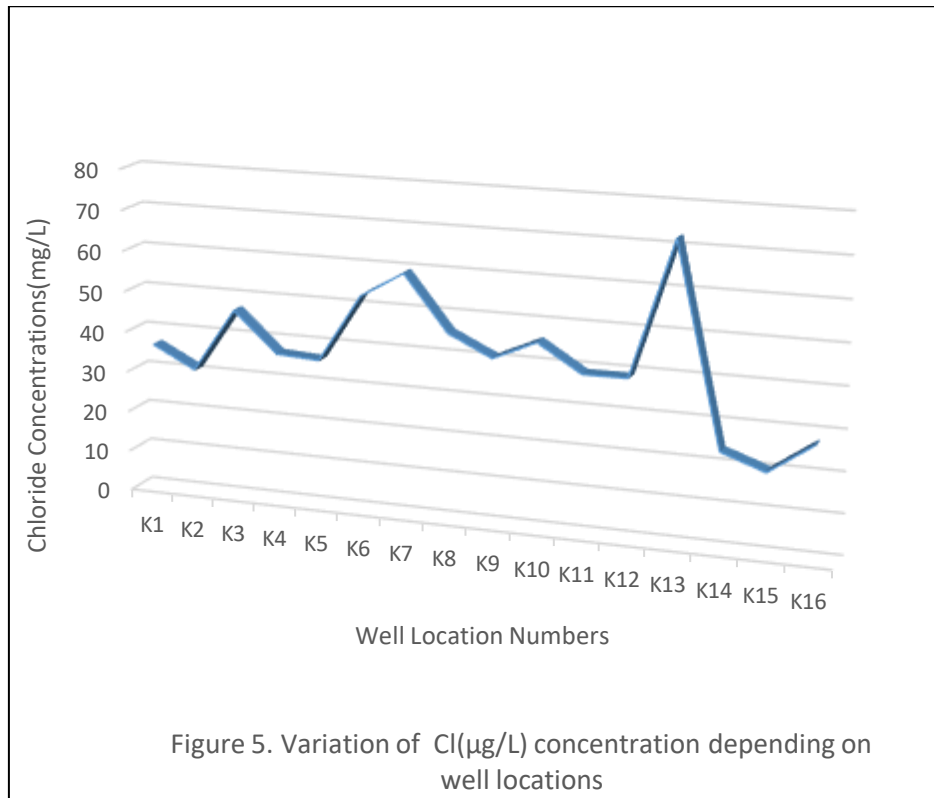

The upper limit of chloride concentration in TS266, World Health Organization (WHO), US Environmental Protection Agency and European Union EC standards is 250 mg/L. The highest chloride concentrations were found in wells K13, K7 and K3, respectively. The chloride concentration in well K13 is 72.43 mg/L. Considering the well location and industrial density, no correlation was found between chloride concentration and industry. K14-K16 wells are located closer to the sea than other wells. Low chloride concentrations indicate that there is no seawater intrusion.



3.5. Change of Iron(Fe) concentration depending on the well location

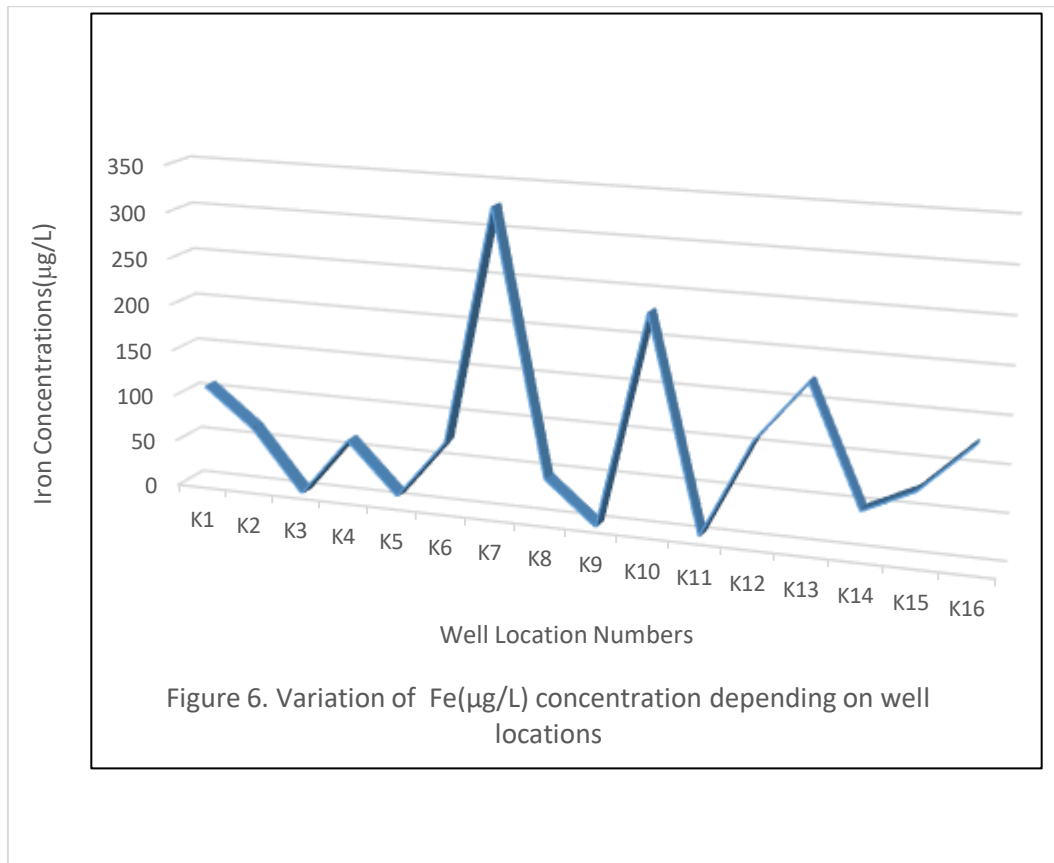

As seen in Figure 6, iron concentrations appear to increase and decrease regardless of the well locations. Iron concentration varies between 200 and 300µm in TS266 and other standards. Concentrations of 327.3µg/L and 230.8µg/L were measured in wells K7 and K10, respectively. The iron concentrations measured in these two wells exceed the upper limit limits specified in TSE266. According to WHO standards, it is below the limit. K7 well is close to industrial and residential centers. Well K10 is a well located in rural areas close to settlement. When well locations and iron concentrations were correlated, a linear relationship could not be determined between industrial proximity and residential proximity. The high concentration of iron is due to clogging in the pipes and color formation in the water, rather than health problems.



3.5. Manganese (Mn) concentration variation depending on the well location

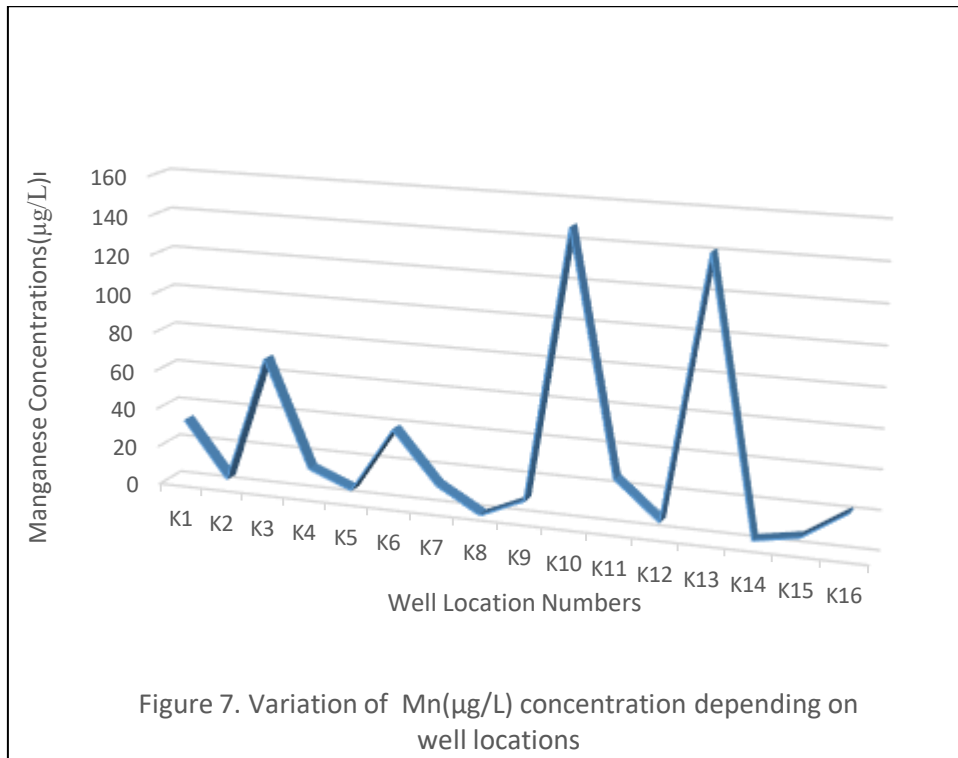

Figure 7 shows the distribution of manganese concentrations by well locations. According to TS266, the upper limit is 50 µg/L, and according to WHO standards, the upper limit of Manganese is 100 µg/L. Manganese concentrations in K3, K10 and K13 wells were measured as 69.31µg/L, 148.2 µg/L and 141.13 µg/L, respectively. Well K13 is one of the most polluted wells in terms of other parameters. This well is in a rural residential area away from industry. No industrial pollution relationship was found. All three wells exceed TS266 upper limit values. The high manganese concentration is thought to be related to the groundwater rock structure and soil cover. The manganese parameter causes an increase in the color parameter of the waters as well as the iron content. Very high concentrations increase the hardness of the water.

4. REFERENCES

1. Abdalla, F., Khalil, R. (2018). Potential effects of groundwater and surface water contamination in an urban area, Qus City, upper Egypt. *Journal of African Earth Sciences*, 141, 164-178.
2. Almasri, M.N., Kaluarachchi, J.J. (2004). Assessment and management of long term nitrate pollution of ground water in agriculture dominated watersheds. *Journal of Hydrology*, 295, 225-245.
3. Al Taai, S.H.H (2021). Ground water: A study of its importance, its sources, and the causes its pollution. *Materials Today: Proceedings* (In Press).
4. Archer, D.W., Shogren, J.F. 2001. Risk indexed herbicide taxes to reduce ground and surface water pollution: An integrated ecological economics evaluation. *Ecological Economics*. 38, 227-250.



5. Chatterjee, A., Das, D., Chakraborti, D. (1993). A study of ground water contamination by arsenic in the residential area of Behala, Calcutta due to industrial pollution. *Environmental Pollution*, 80(1), 57-65.
6. DeBorde, D.C., Woessner, W.W., Lauerman, B., Ball, P.N. 1998. Virus occurrence and transport in a school septic system and unconfined aquifer. *Ground Water*, 36(5), 825-834.
7. Delgado, J.A., Shaffer, M.J., 2002. Essentials of a national nitrate leaching index assessment tool. *Journal of Soil and Water Conservation* 57, 327–335.
8. Hall, M.D., Shaffer, M.J., Waskom, R.M., Delgado, J.A., 2001. Regional nitrate leaching variability: what makes a difference in northeastern Colorado. *Journal of the American Water Resources Association* 37(1), 139 –408
9. Harter, T., Davis, H., Mathews, M., Meyer, R., 2002. Shallow ground water quality on dairy farms with irrigated forage crops. *Journal of Contaminant Hydrology* 55, 287 –315.
10. Lang, Y.C., Liu, C.Q., Zhao, Z.Q., Li, S.L., Han, G.L. (2006). Geochemistry of surface and ground water in Guiyang China: Water/rock interaction and pollution in a karst hydrological hydrological system. *Applied geochemistry*, 21, 887-903.
11. Postma, D., Boesen, C., Kristiansen, H., Larsen, F. (1991). Nitrate reduction in an unconfined sandy aquifer: water chemistry, reduction processes, and geochemical modeling. *Water Resources Research* 27(8), 2027–2045.
12. Rozemeijer, J.C., Broers, H.P. 2007. The groundwater contribution to surface water contamination in a region with intensive agricultural land use. *Environmental Pollution*, 148, 695-706.
13. TESKI- 2015-2020 Water Data



INVESTIGATION OF THE CHANGE OF SULFATE, NITRATE, NITRIDE, AMMONIUM, CONDUCTIVITY AND pH PARAMETERS IN WELLS CLOSE TO INDUSTRIAL AND RURAL AREAS

İbrahim Feda ARAL

Ali Rıza DİNÇER

Department of Civil Engineering, Çorlu Faculty of Engineering, Tekirdağ Namık Kemal University, Tekirdağ, Turkey

ORCID:0000-0002-9294-0643

**Department of Environmental Engineering, Çorlu Faculty of Engineering, Tekirdağ Namık Kemal University, Tekirdağ, Turkey

ORCID:0000-0002-9294-0643

Abstract

The distribution of inorganic pollutants such as conductive, pH, sulfate, nitrite, nitrate and ammonia in groundwater were investigated. In this direction, limit values of Turkish Standards TS266, World Health Organization (WHO), USA Environmental Protection Agency, European Union EC standards have been taken into consideration.

Between 2015 and 2020, the physico-chemical components of a total of 16 groundwater wells from 4 sites were evaluated during the rainy and dry seasons. One of the biggest indicators of domestic and industrial contamination of wastewater is nitrate pollution. Nitrate concentration was found to be high in 4 of 16 wells. The highest nitrate concentration was found in the K7 well. Both nitrate and nitrite concentrations were found to be high in this well. Nitrite concentration was two times higher than the upper limit value. Nitrite concentration was measured at 1.3 mg/L in well K7. Ammonium ion was measured below standard limits in all wells. 0.25 mg/L was detected only in the K10 well. The K10 well is located in the rural settlement area. There is no link to industrial pollution. Sulfate concentrations were measured well below the standard limits. Agricultural, domestic and industrial pollution could not be detected in all wells. The conductivity values in the wells vary between 290-651 $\mu\text{S}/\text{cm}$. No industrial wastewater contamination could be detected in these wells.

In general, nitrate and nitrite concentrations are below the limit values. This shows that the well waters are not contaminated with agricultural and domestic wastewater. Organochlorine, organophosphorus, herbicide, fungicide, carbamate, organochlor, PAH, VOC and trihalomethanes were not detected in these wells.

Keywords: Nitrate, Groundwater, organic pollution

1.INTRODUCTION

Groundwater constitutes one of the important water resources in the world. The chemical and biological content of groundwater varies depending on the natural environment and human activity. Filtration of rain water and surface waters constitute the main source of groundwater. The amount of suspended matter in groundwater is low and its chemical composition is variable. As a result of



vertical and horizontal movements of groundwater, its chemical content changes depending on the soil and rock structure it is in. creates bacteriological pollution.

Groundwater is one of the widely used natural resources, accounting for about twenty percent of the world's freshwater supply, which is about 0.61% of the entire world's water (Alsalmeh et al., 2021). Groundwater flood, earthquake, etc. External factors including meteorological events cause pollution and chemical imbalance in the water body. The plankton population in the water body disrupts the biochemical processes occurring in the water and affects the optimal physicochemical parameter range (Zamxaka et al., 2004; Alsalmeh et al., 2021). Waste left in the open area creates leaks from precipitation, which contains a large amount of organic and inorganic compounds. Areas close to landfills have a greater risk of this groundwater contamination (Munagala et al., 2020). Fertilizer use and industrial wastes are the two main anthropogenic causes of groundwater pollution. Arsenic and cadmium are two of the main heavy metal pollutants that affect groundwater quality through human activities. Serious effects can occur when humans are exposed to both carcinogenic and non-carcinogenic pollutants for a long time. Prolonged exposure to low amounts of pollutants can impair health (Kayastha et al., 2022).

While the most important source of groundwater is precipitation, climate change has led to changes in groundwater levels. Climate change has altered precipitation and hydrological patterns, resulting in a reduction in groundwater recharge in many regions. Increased seawater inflow and insufficient rainfall as a result of decreasing groundwater level led to deterioration of water quality by increasing electrical conductivity and salinity and lowering the water level, respectively (Corwin, 2021). Septic systems, chemicals, mining, landfills, animal wastes contaminate groundwater. The two main anthropogenic factors of groundwater pollution are fertilizer application and improper industrial waste management, which leads to its leaching into groundwater (Adeyemi et al., 2021).

In this study, parameters such as pH, electrical conductivity, nitrate, nitrite, ammonia, sulfate, organochlorine, organophosphorus, herbicide, fungicide, carbamate, organochlorine, PAH, VOC and trihalomethanes were used in the evaluation of groundwater pollution in order to observe the current state of groundwater quality.

2. MATERIAL AND METHOD

Samples were collected as part of the sampling process. Samples were taken to evaluate organic and inorganic pollution in industrial remote areas and near industrial areas. Water samples were collected at varying depths in these wells. The samples were analyzed by the Istanbul Public Health Directorate Public Health Laboratory No. 2. TSENISO10304-1/ION CHROMATOGRAPHY (Bromat, H, Cl, NO₃, NO₂, Sulphate), GC-ECD (Aldrin, DDT.....), LCMS/MS (Diazinon, Ethion...), HPLC-RF by Public Health Laboratory in Measurements (Benzo pyrene...), EPA524.2/GC-MS/PURGE TRAP(Chloroform.....), TS9748EN27888/CONDUCTIMETRIC (Conductivity) devices were used.

3. CONCLUSIONS AND DISCUSSION

The concentration changes of organic and inorganic pollutants measured in 16 wells at four different sites were investigated. Each parameter is given graphically depending on the location of the well, and the results are examined.



3.1. Nitrate (mg/L) concentration variation depending on the well location

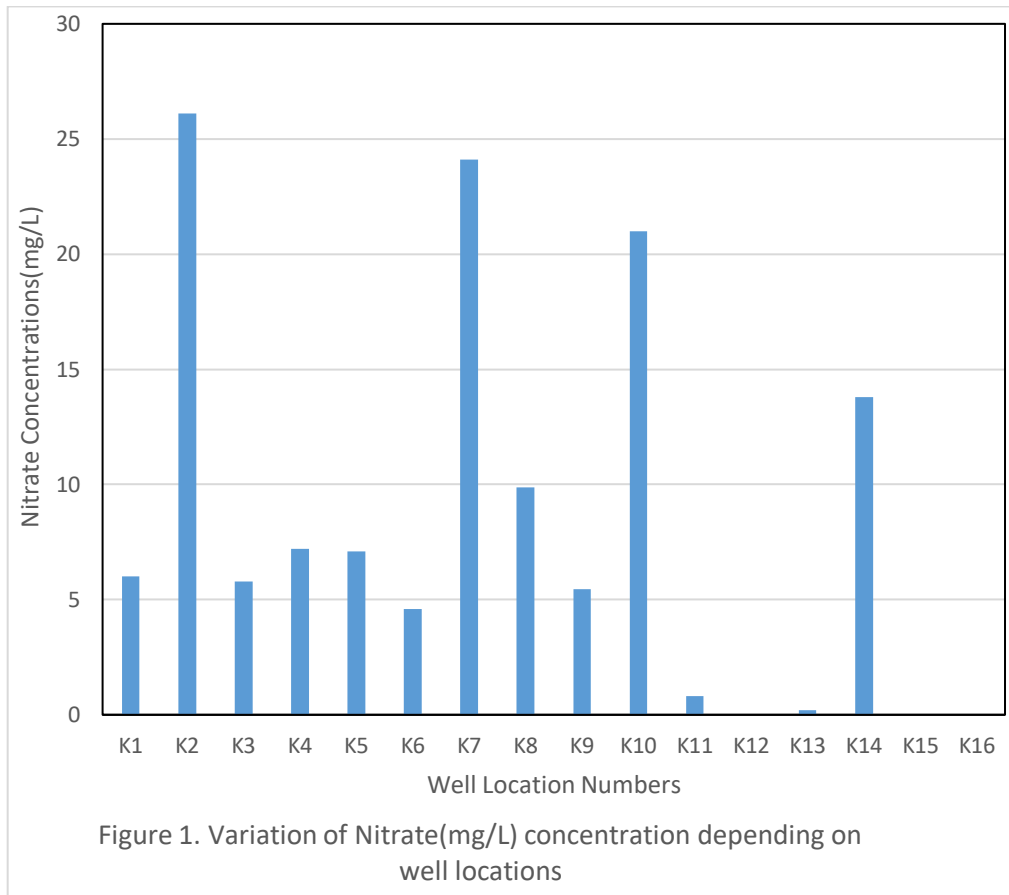

As seen in Figure 1, nitrate exchange bar diagrams are given depending on the well locations. K2 and K7 wells are close to industrial and residential areas. K10 is a well in a rural residential area. K14 is located very far from the industry, close to the city center. Nitrate concentrations in wells K2, K7, K10 and K14 were measured as 26.1 mg/L, 24.1 mg/L, 21 mg/L and 13.8 mg/L, respectively. TS266 and WHO; It does not exceed the upper limit values of the US Environment Agency, European Union standards. According to these standards, the upper limit value of nitrate is 45 and 50 mg/L. Nitrate concentrations were found below 10 mg/L in other well locations. Nitrate pollution originates from three points: domestic, industrial and agricultural. Considering the well locations, industrial settlements and urban settlements, it is thought that the main source of nitrate is fertilizers used in agriculture. Nitrate industry relationship could not be determined.



3.2. Nitrite (mg/L) concentration variation depending on the well location

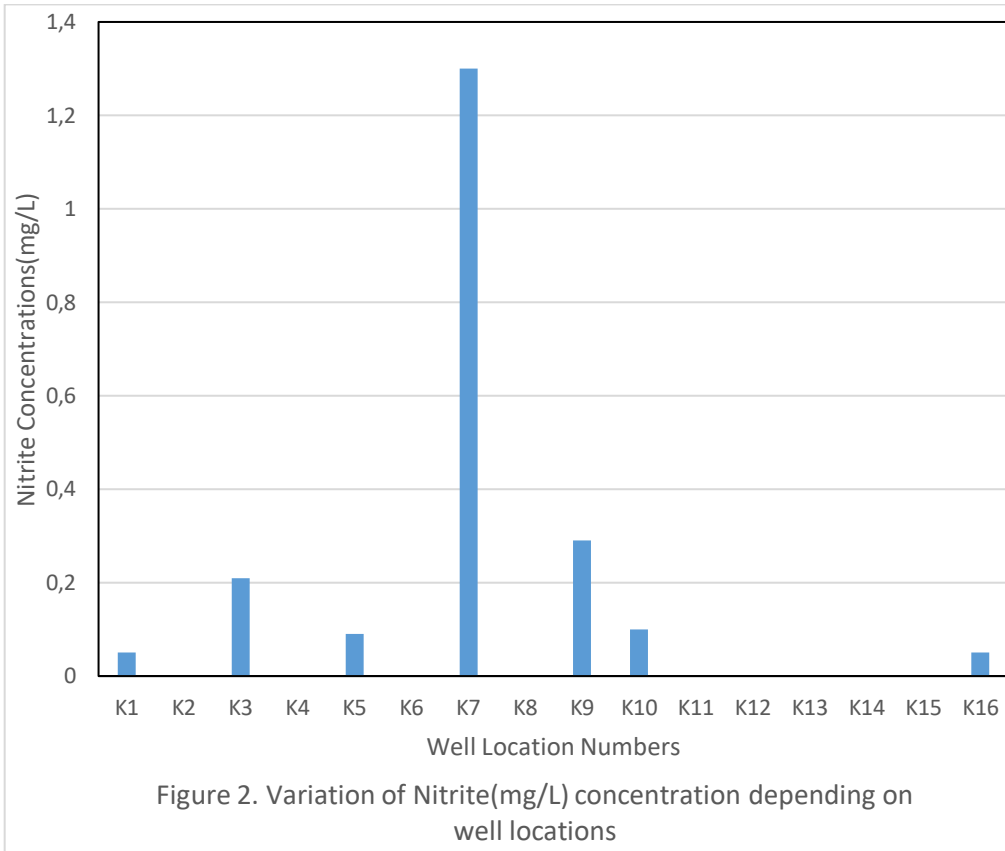

Nitrite concentrations are shown in Figure 2. Nitrate and nitrite concentrations are interdependent parameters. Domestic and industrial wastes first transform into ammonium, nitrite and finally nitrate form. Nitrite and ammonia pollution is used as fresh pollution, and nitrate pollution is used as an indication of an older pollution. When Figure 1 and Figure 2 are compared, it is seen that nitrate and nitrite concentrations are high in the K7 well and nitrate is converted to nitrite. It is seen that the nitrite concentration exceeds the TS266 and other standard limits in the K7 well. The K7 well is within the city location boundaries. This suggests that there may be domestic wastewater contamination. Other wells were generally found to be less than 0.2 mg/L concentration. Considering the well locations and industrial settlements, it was concluded that there was no industrial wastewater intrusion in these wells.



3.3. Variation of ammonium (mg/L) concentration depending on well location

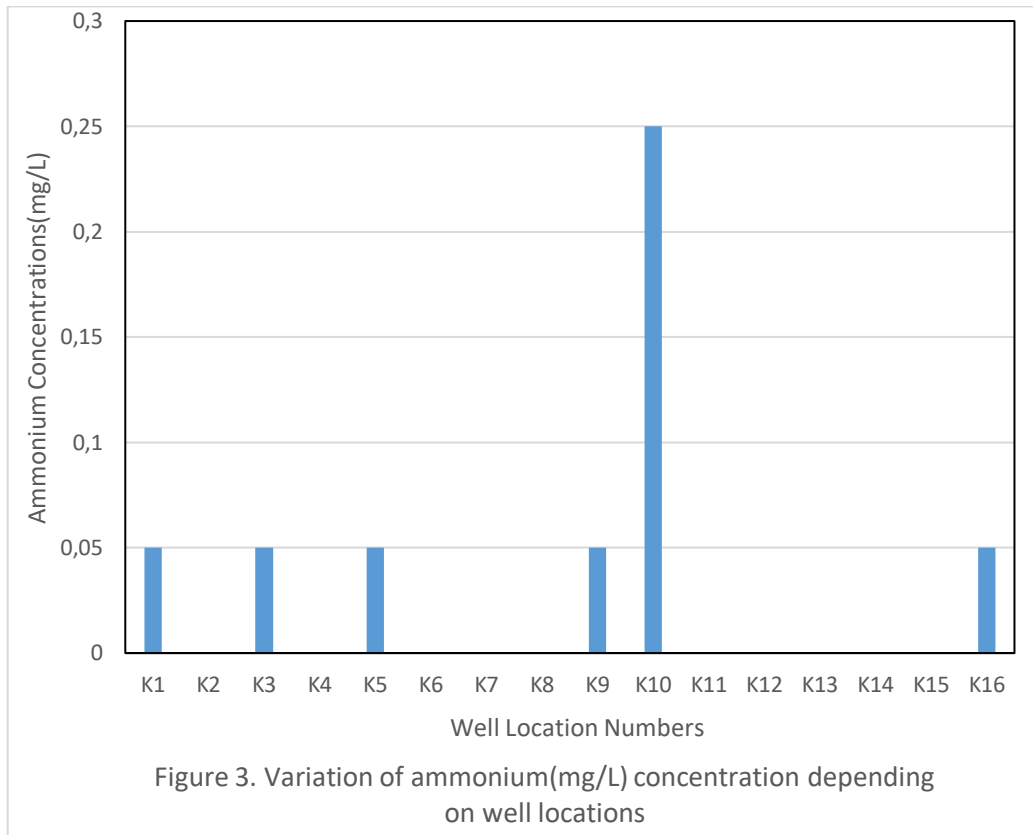

Ammonium ion concentrations are given in Figure 3. In TS266 and other international standards, the ammonium ion concentration is 0.5 mg/L. The ammonium concentration in all wells does not exceed the limit values. The highest K10 well was found to be 0.25 mg/L. The ammonium ion concentration shows that there is no fresh contamination in the wells. Ammonium ion causes nitrification in receiving environments and causes oxygen consumption. In addition, it turns into nitrite and has a toxic effect on the environment. Nitrite concentration was found below 0.05 mg/L in all of the other wells. The K10 well is located in an agricultural area in a rural settlement. Therefore, there is no domestic, agricultural or industrial contamination in these wells.



3.4. Variation of sulphate (mg/L) concentration depending on the well location

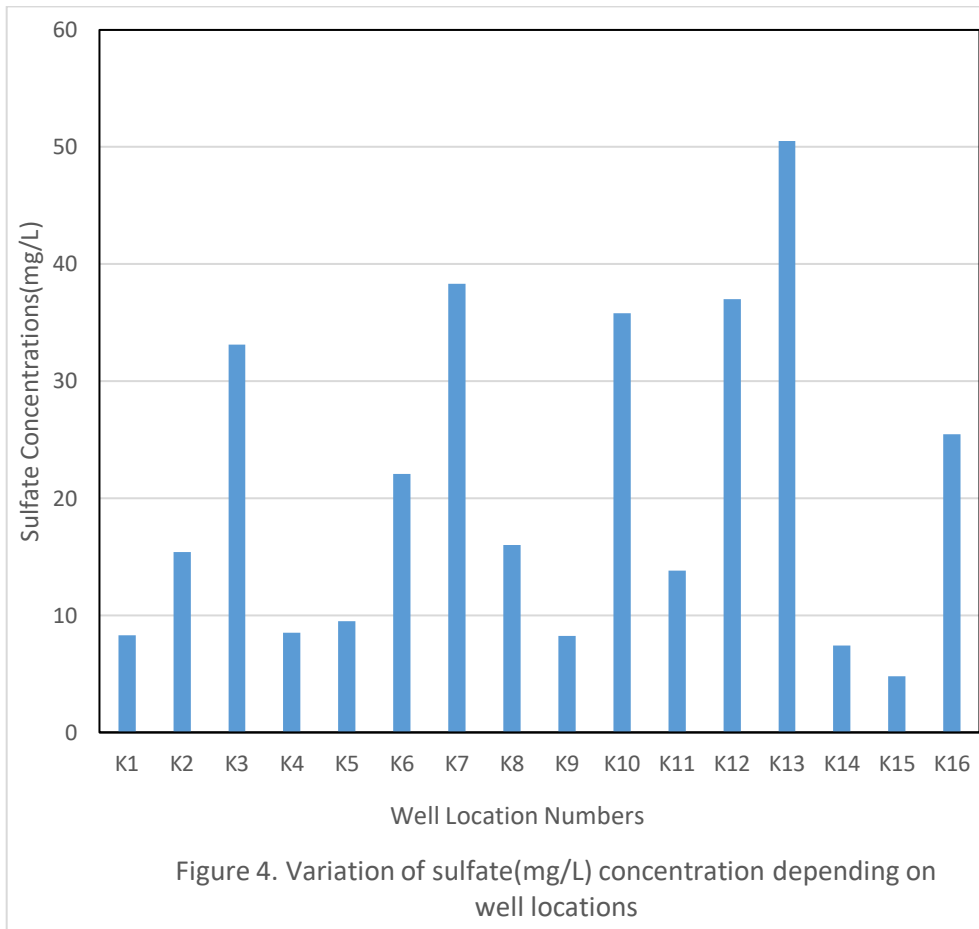

Sulphate concentrations in all wells are given in Figure 4. The upper limit value for sulfate concentration in TS266 and other standards is 250 mg/L. As seen in Figure 4, the sulfate concentrations measured in the wells were found to be very low. The high sulfate concentration in drinking water causes problems in the intestines. Sulfate pollution originates from industrial origin or from the structure of rocks and soil. K13 well has the highest sulfate concentration compared to other wells (50.54 mg/L). There is no sulfate pollution from industries in the wells.



3.5. Change in conductivity ($\mu\text{S}/\text{cm}$) depending on well location

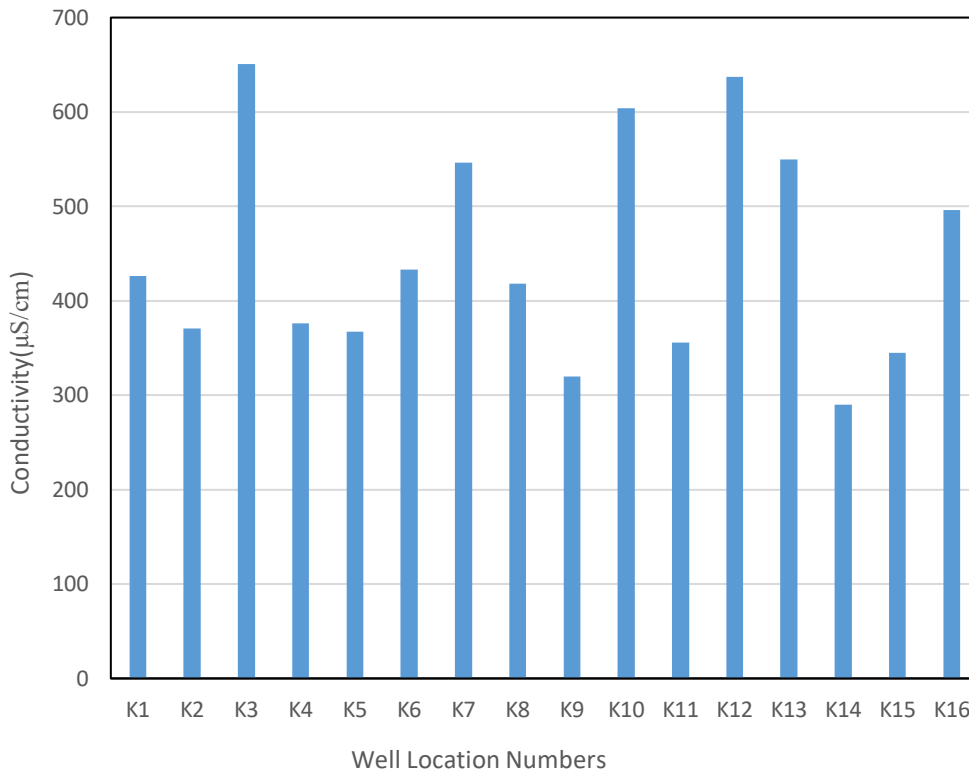
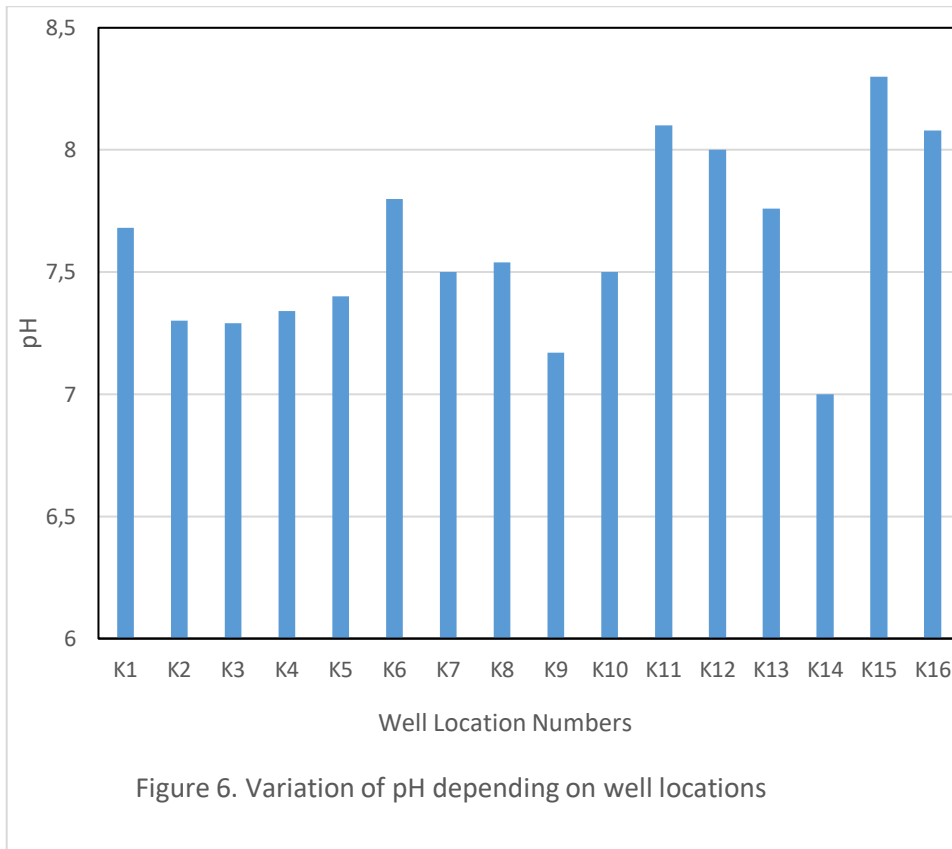

Figure 5. Variation of Conductivity($\mu\text{S}/\text{cm}$) depending on well locations

In Figure 5, conductivity values are given depending on the well locations. In wells K3, K7, K10, K12, K13 and K16, the conductivity values were found to be 651 $\mu\text{S}/\text{cm}$, 546 $\mu\text{S}/\text{cm}$, 604 $\mu\text{S}/\text{cm}$, 637 $\mu\text{S}/\text{cm}$, 550 $\mu\text{S}/\text{cm}$ and 496 $\mu\text{S}/\text{cm}$, respectively. It was detected below 400 $\mu\text{S}/\text{cm}$. The average conductivity value in domestic wastewater is 2500 $\mu\text{S}/\text{cm}$. The high conductivity value in groundwater is related to the rock and soil structure. High conductivity indicates that cations and anions are high. When the well locations were examined, no industrial wastewater contamination relationship was detected.



3.6. pH change depending on well location



The pH change in the wells is shown in Figure 6. The pH change varies between 7 and 8.3. The highest pH value was obtained in the K15 well. pH over 8 was measured in wells K11, K12, K15 and K16. It is not possible to establish a relationship between pH and pollution. The relationship between industry and domestic pollution could not be determined in the wells. The pH in wastewater varies in very different ranges. The pH change in well waters varies depending on the rock and soil structure.

4. REFERENCES

1. Adeyemi, A.A., Ojekunle, Z.O. 2021. Concentrations and health risk assessment of industrial heavy metals pollution in groundwater in Ogun state, Nigeria. *Scientific African* 11, e00666
2. Alsalmeh, A., Al-Zaqri, N., Ullah, R., Yaqub, S. 2021. Approximation of ground water quality for microbial and chemical contamination. *Saudi Journal of Biological Sciences*, 28, 1757-1762.
3. Corwin, D.L. 2021. Climate change impacts on soil salinity in agricultural areas. *Eur. J. Soil Sci.* 72 (2), 842–862
4. Kayastha, V., Patel, J., Kathrani, N., Varjani, S., Bilal, M., Show, P.L., Kim, S.H., Bontempi, E., Bhatia, S.K., Bui, X.T. 2022. New insights in factors affecting ground water quality with focus on health risk assessment and remediation techniques. *Environmental Research*, 212, 113171.
5. Munagala, S., Jagarapu, D.C.K., Reddy BSS, R. 2020. Determination of water quality index for ground water near municipal dump site in Guntur. *Materials Today: Proceedings*, 33, 724-727.



INTERNATIONAL ASIAN CONGRESS ON CONTEMPORARY SCIENCES – VII

6. Zamxaka, M., Pironcheva, G., Muyiman, Y.O. 2004. Microbial and physicochemical Assessment of the quality of domestic water sources in selected rural communities of Eastern Cape Province “South Africa Water SA.30(333).

7. TESKI- 2015-2020 Water Data



**SURFACTANT-MEDIATED OPTICAL BANDGAP ADJUSTMENT OF
NANOSTRUCTURED ZNO THIN FILMS**

Rasit AYDIN

Bunyamin SAHIN

Selcuk University, Faculty of Sciences, Department of Physics, Konya, Turkey

Hatay Mustafa Kemal University, Faculty of Arts and Sciences, Department of Physics, Hatay, Turkey.

Abstract

Zinc oxide (ZnO) is a multi-functional metal-oxide material with matchless chemical and physical specialities such as great chemical stability, high conductivity, high transparency, and electron mobility. In addition, ZnO is a low-cost, non-toxic, and thermally stable material with a big band gap of 3.37 eV, showing an n-type semiconductor property. In this study, glycine-free and varying contents glycine (4.0 and 8.0 M %) ZnO thin films were prepared on glass slides using the cheap Successive Ionic Layer Adsorption and Reaction (SILAR) method. The effect of increasing glycine content on the morphological, structural, and optical features of the produced ZnO thin films was analyzed. Scanning electron microscopy (SEM) was used to analyse the surface morphological structures of all ZnO thin films. Chemical composition was done by energy-dispersive X-ray spectroscopy (EDX). The structural characteristics and crystal structures of the films were studied by X-ray diffraction (XRD) analysis. UV-visible spectroscopy was used to investigate optical properties such as absorbance and transmittance. Film thicknesses were measured using a profilometer. SEM photo images show that the percentage of glycine affects the surface morphology of nanostructured ZnO films. It is seen from the XRD patterns that the diffraction peak intensities of the ZnO films are strongly dependent on the glycine concentration value. The absorption and transmittance disclose reveal that the transmittance and optical bandgap of the films vary with glycine ratios.

Keywords: ZnO thin film, Surfactant, Glycine, SILAR, Bandgap

1. Introduction

Metal-oxide (MO) semiconductor nano materials have been of attention to many scientists due to their interesting physical features and wide suitable applications in electronic and optoelectronic-based technologies (Badawi et al., 2021; Mala et al., 2022). The fact that MO semiconductor structures have a wide variety of electronic and physical properties such as easy fabrication, low cost, resistance values close to metallic conductivity, low power consumption and suitability for microstructure electronic applications make these materials interesting materials for basic research and technological applications (Munir et al., 2022; Demiryürek et al., 2021).

Among MO, zinc oxide (ZnO) is a compound consisting of the elements zinc and oxygen. ZnO is an n-type material with a conductivity of about 10^{-7} - 10^{-3} S/cm. It has a broad band gap (E_g) of 3.37 eV and a big exciton binding energy (60 meV) at room temperature. Having a Wurtzite crystal structure, ZnO has high conductivity, transparency, and electron mobility. It has high energy density, electrical and piezoelectric properties. It is an abundant, low-cost, non-toxic, chemically and thermally stable substance. Due to its optical and electrical properties, it is predicted as a promising material in electro-optical applications (Taşdemir et al., 2021; Mia et al., 2020; Muzaffar et al., 2020).



Due to its excellent physical, electrical, optical, and chemical attributes, ZnO materials have a great range of applications such as biosensors, gas sensors, solar cells, catalysis, lithium-ion batteries, phototransistors, photodiodes, smart windows, flat panel displays, transistors, fuel cells and antibacterials (Rajaboopathi and Thambidurai, 2019; Akram et al., 2021).

ZnO thin films can be produced using different thin film fabrication techniques such as chemical vapor deposition, chemical bath deposition, thermal evaporation, sputtering, sol-gel, hydrothermal, spray pyrolysis, pulsed laser deposition, and successive ionic layer adsorption and reaction (SILAR) (Ribut et al., 2019; Musharaf et al., 2021). Among these ways, SILAR is a method that is inexpensive, safe, and easy to apply and has the advantage of allowing easy control of different parameters during the synthesis (Ravichandran et al., 2015; Şahin et al., 2020).

Various techniques have been developed by researchers to enhance the desired physical performance of nanostructured ZnO films according to their intended use. One of these methods is to use surfactants in the solution. Glycine, with the chemical formula $C_2H_5NO_2$, is cost-effective and one of the complexing agents. Glycine can be used as an additive to advance deposition quality in producing ZnO films in Zn^{2+} solution (Hwang and Wu, 2004; Pang et al., 2010).

As far as we know, there is no work in the literature on Glycine-added ZnO films synthesized by the SILAR method. Therefore, this work aims to analyze the impact of glycine as a surfactant on the physical characteristics of ZnO films.

2. Materials and methods

In our experiment, $Zn(NO_3)_2 \cdot 6H_2O$ compound (Zinc nitrate hexahydrate)(Merck) was used as Zn^{2+} ion source, and $C_2H_5NO_2$ (Glycine) (Sigma-Aldrich) compound was used as a surfactant. ZnO thin films with varying concentrations of glycine were obtained on a glass substrate by the economical SILAR procedure. In order to prepare the Zn^{2+} ion solution, the $H_{12}N_2O_{12}Zn$ compound was added to 100 mL of distilled water and a 0.1 M solution was obtained. To adjust the pH of the Zn synthesis solution to 10, an aqueous ammonium hydroxide (NH_4OH) solution was included to the mixed solvent. The temperature of the prepared $Zn(NO_3)_2$ solution was adjusted to 90 °C and kept constant at this temperature. After the temperature of the solution and pure water reached 90 °C, the previously cleaned glass slides were immersed in the solution. Each dipping and rinsing process was done for 15 seconds, and after each rinsing process, a 15-second drying process was applied to the slides. Thus, one SILAR tour was completed. 25 SILAR rounds were performed for each experiment, and ZnO films were produced at the end of 25 rounds. In order to examine the impact of glycine on ZnO films, different proportions of glycine were added to the Zn^{2+} ion solution. Glycine-added ZnO films were obtained by applying the above procedures in the same way. Before proceeding to the characterization processes of glycine-free and glycine-containing ZnO films, the films were annealed in a thermal oven at 250 °C for 30 minutes.

Surface morphology images were taken with Zeiss EVO LS10 brand scanning electron microscope (SEM) for the morphological examination of the produced thin films. In addition, EDX measurements of the samples were taken with the EDX device connected to the SEM device for elemental analysis. Bruker D8 Advance brand X-Ray diffractometer (XRD) device was used to determine the structural attributes of the films to be produced. The optical properties of the films were performed with Thermo Scientific Genesys 10S spectrophotometer in the range of 350–1200 nm. The thickness of the synthesized films was determined with the NanoMap-500 LS model profilometer.



3. Results and discussion

Figure 1 displays SEM microphotos of ZnO films prepared on a glass slide without any glycine and with varying concentrations of glycine. It is understood from the figure that all ZnO films produced are crack-free and well-adhered to the glass slide. While the glycine-free ZnO film shows cauliflower-like morphology, the glycine ZnO films show rod-like surface structure. That is when glycine was added to the Zn^{2+} reaction bath, the surface structure of the films changed with ascending glycine content in the reaction bath. The alterations in the particle thickness of the ZnO films with the glycine agent were observed from the SEM photographs in Figure 2. The mean particle thickness values obtained for films from SEM images were found to be 493.75 nm (ZnO), 597.65 nm (4.0% Glycine), and 536.80 nm (8.0% Glycine), respectively.

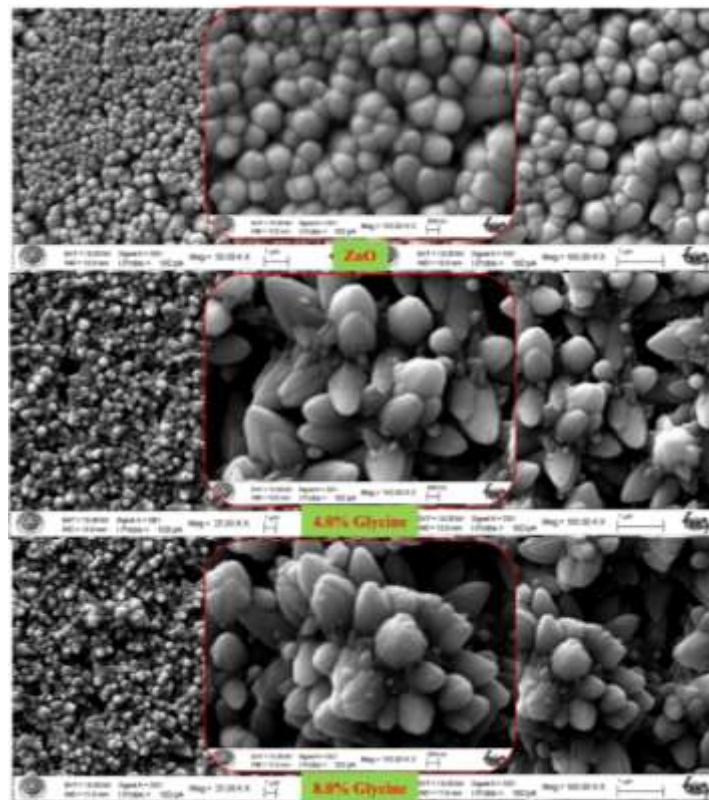

Figure 1. SEM microimages for the ZnO film synthesized with and without glycine.



Figure 2. Magnified SEM microimages for the ZnO films synthesized with and without glycine.



These alterations in the morphological structures and particle thicknesses of ZnO films with the addition of glycine to the aqueous Zn^{2+} solution can be referred to the steric and synergistic effect of glycine (Barry and Cunnane, 2002; Taha et al., 2013).

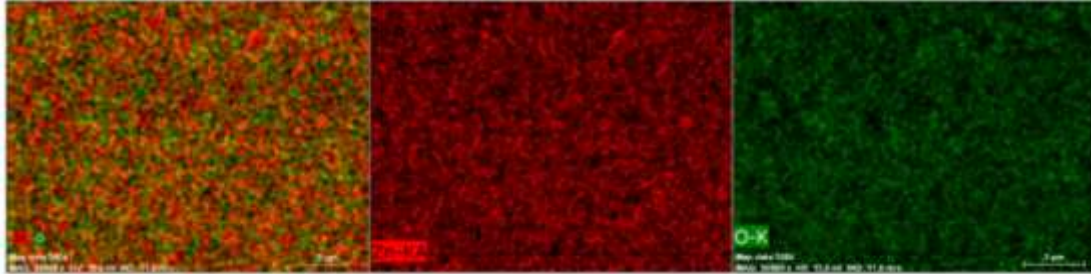

Figure 3. EDX mapping analysis photos of ZnO film deposited on a glass substrate.

The content of the glycine-free ZnO film was examined by EDX mapping (Figure 3) and elemental mapping was made to indicate the Zn and O distribution in the structure of the film. These mapping images in Figure 3 show the homogeneous presence of all possible elements in the ZnO film. In addition, Figure 3 shows elemental mapping in red for Zn and green for O.

Figure 4 denotes the XRD pattern of a typical ZnO film procured by using glycine as a surfactant in the SILAR process. This pattern shows a dominant peak at about 34.90° and 36.72° and smaller diffraction signals at about 32.20° , 48.05° , 57.05° , 62.93° , 68.36° and 69.49° , which can be assigned to the reflections by (002), (101), (100), (102), (110), (103), (200) and (112) planes of the ZnO wurtzite crystalline phase (JCPDS Card No. 05-0640) (Singh et al., 2010). The absence of an additional diffraction peak of any impurity in the diffraction pattern indicates the synthesis of ZnO with high crystallinity. It can be seen from Figure 4 that the diffraction line heights of ZnO films change with an increasing percentage of surfactant glycine. Besides, it can be seen from Figure 4 that when glycine is added to the Zn^{2+} aqueous solution, there are shifts in the intense (002) and (101) orientation peaks.

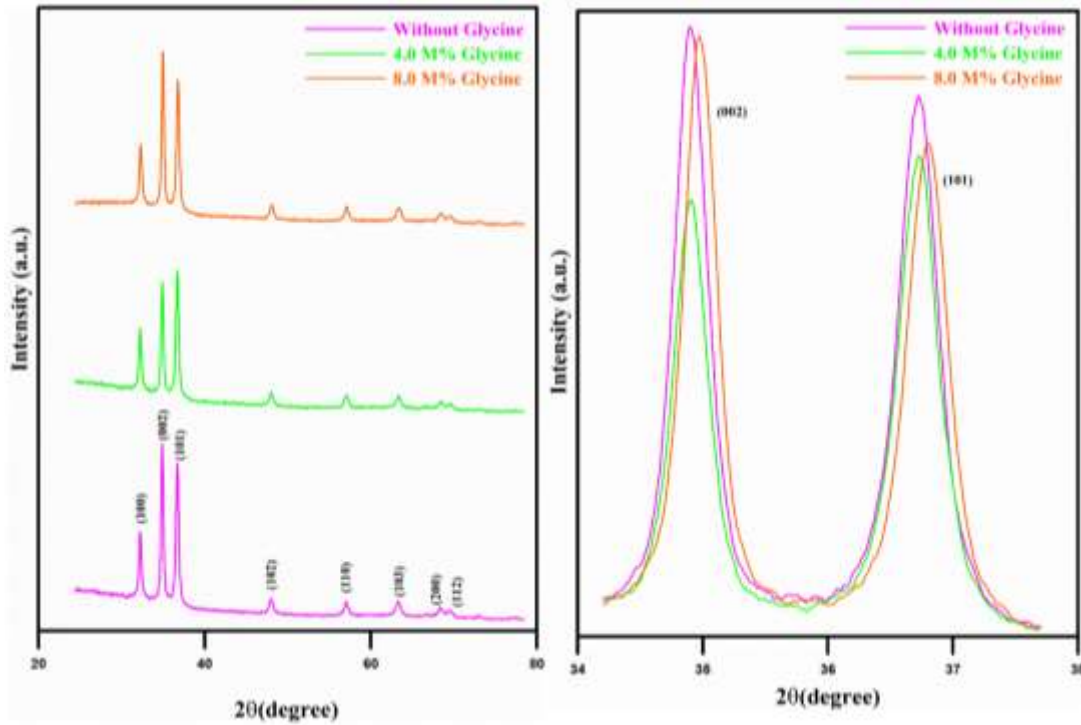

Figure 4. X-ray models of ZnO films at various glycine contents

The changes and shifts in the diffraction lines may be due to the change in the reaction rate with the addition of glycine and the effect of glycine on the electro-crystallization processes (Inamdar et al., 2008; Ergeneman et al., 2011).

The Scherer rule is given in Equation 1 (Akkaya ve et al., 2021) was used to obtain the lattice parameter such as the crystallite size (*D*).

$$D = \frac{0.94\lambda}{\beta \cos \theta} \tag{1}$$

λ , β and θ are defined in ref (Akkaya ve et al., 2021). The crystallite sizes of the produced ZnO films increased from 18.22 nm to 25.68 nm depending on the increasing percentage of glycine. These *D* values are tabulated in Table 1. This increase in *D* may be due to the preparation conditions and the change in the lattice structure of ZnO when glycine is added to the solution (Mahmoud et al., 2022; Aydin, 2018).

Table 1. Crystallite size, bandgap, and thickness values of ZnO films at different glycine content.

Glycine Content (%)	Crystallite Size (nm)	Bandgap (eV)	Film Thickness (μm)
0	18.22	3.18	1.52
4.0	22.27	3.15	1.71
8.0	25.68	3.12	1.93

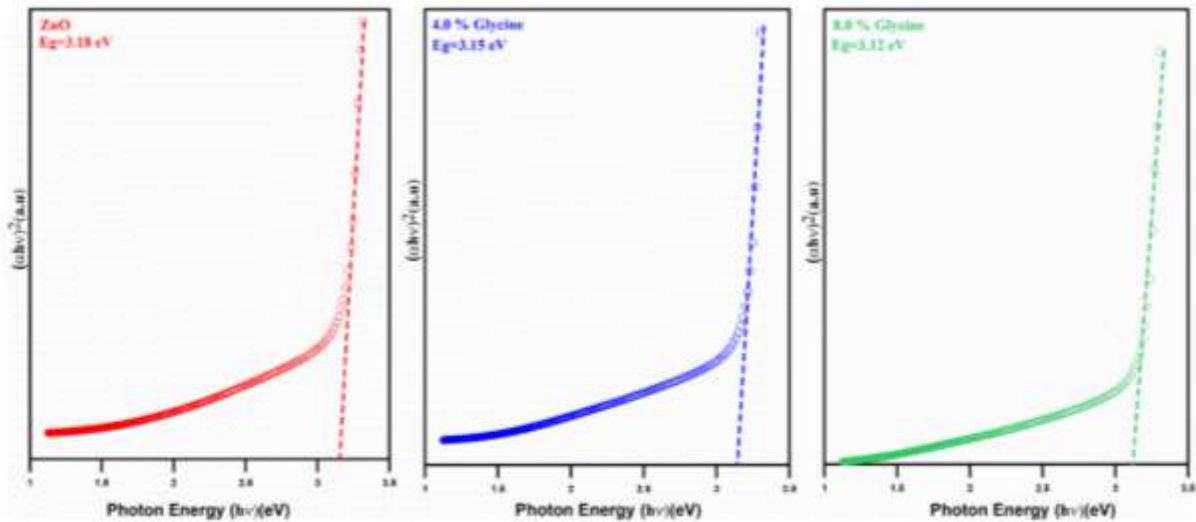

Figure 5. Tauc's plot of deposited ZnO films with different glycine content.

Since the energy band gap (E_g) is an important property for semiconductor materials, it has an important role in investigating the behavior of the semiconductor ZnO film. E_g values of all ZnO films produced using the well-known Tauc formula (Equation 2) were obtained (Aydin ve Sahin, 2018).

$$\alpha hv = C(hv - E_g)^n \quad (2)$$

α , hv , C , and n are defined in ref (Aydin ve Sahin, 2018). The plot of $(\alpha hv)^2$ versus (hv) for all ZnO films are shown in Figure 5. The resulting optical band gaps are tabulated in Table 1 and it can be seen from both figure 5 and table 1 that E_g values decrease with an increasing percentage of glycine. The reason for the E_g change may be the electrostatic reaction between the Zn^{2+} ion and the glycine added to the solution during the synthesis process (Rahman et al., 2015).

The transmittance curves of the ZnO films in the 350-1200 nm region depending on the glycine level are shown in Figure 6. The glycine-free ZnO film appears to have the greatest transmittance (about 33%) at longer wavelengths (1100 nm) in the near-infrared region. The transmittance decreased with increasing glycine concentration in the reaction mixture. This decrease in transmittance may depend on the deposition time and film thickness (González-Panzo et al., 2014). It was also found that the film thicknesses increased as shown in Table 1, depending on the increasing glycine ratio.

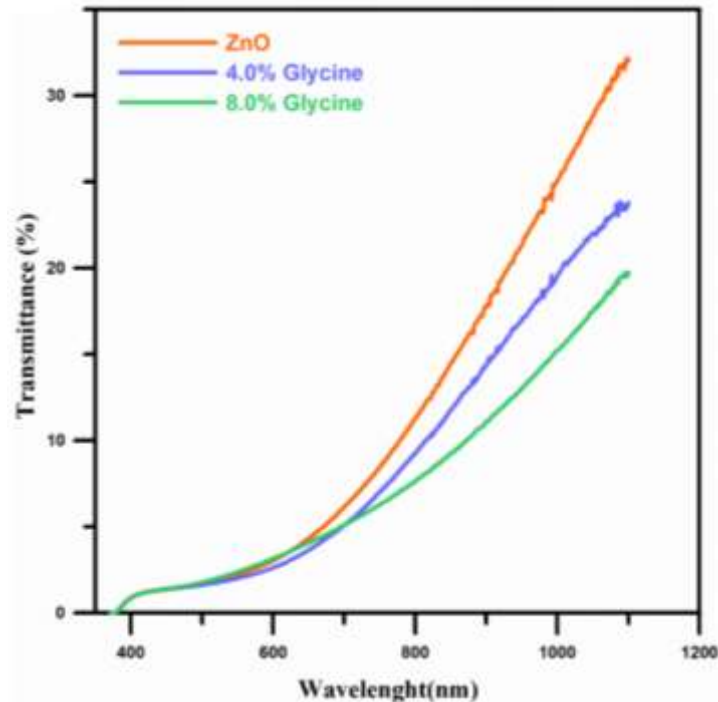

Figure 6. Transmittance curve of ZnO films as a function of glycine level.

4. Conclusion

ZnO films were synthesized with the help of the SILAR procedure, which is a simple and inexpensive deposition method using glycine as a surfactant on a glass substrate, and its effects on the morphological, structural, and optical attributes of the films were investigated. SEM images showed uniform distribution of cabbage and rod-type particle morphology on glass, with an average particle thickness of about 400-600 nm. XRD results confirmed that the produced ZnO films have crystalline wurtzite structures. UV-Visible spectroscopy showed that the band gap for glycine-added ZnO films decreased with an increase in glycine addition compared to glycine-free ZnO.

References

- Akkaya A, Kahveci O, Aydın R, Şahin B 2021. Amplifying main physical characteristics of CuO films using ascorbic acid as the reducer and stabilizer agent. *Applied Physics A*, 127:911.
- Akram N, Guo J, Guo Y, Kou Y, Suleman H, Wang J 2021. Enhanced synergistic catalysis of novel Ag₂O/CuO nanosheets under visible light illumination for the photodecomposition of three dyes. *Journal of Environmental Chemical Engineering*, 9:104824.
- Aydın R, Şahin B 2018. Li:Ce co-doped CdO films synthesized by SILAR method: Effects of rare earth element Ce content on the physical attributes. *Ceramics International*, 44:22249-22254.
- Aydın R 2018. The critical mission of glycine as a surfactant in the improvement of structural, morphological and optoelectronic features of CdO films. *Superlattices and Microstructures*, 117:46-56.



Badawi A, Alharthi SS, Althobaiti MG, Alharbi AN, Assaedi H, Alkhamash HI, Al-Hosiny N 2021. Structure investigation and optical bandgap tuning of La-doped CuO nanostructured films prepared by spray pyrolysis technique. *Applied Physics A*, 127:235.

Barry FJ, Cunnane VJ 2002. Synergistic effects of organic additives on the discharge, nucleation and growth mechanisms of tin at polycrystalline copper electrodes. *Journal of Electroanalytical Chemistry*, 537:151-163.

Demiryürek N, Kivrak B, Akyol M, Ekicibil A 2021. Strong magnetic coupling in MnO₈ nanoparticles by doping Boron. *Journal of Molecular Structure*, 1224:129056.

Ergeneman O, Sivaraman KM, Pané S, Pellicer E, Teleki A, Hirt AM, Baró MD, Nelson BJ 2011. Morphology, structure and magnetic properties of cobalt–nickel films obtained from acidic electrolytes containing glycine. *Electrochimica Acta*, 56:1399–1408.

González-Panzo IJ, Martín-Vázquez PE, Oliva AI 2014. Role of Thiourea in the Kinetic of Growth of the Chemical Bath Deposited ZnS Films. *Journal of the Electrochemical Society*, 161: D761-D767.

Hwang C-C, Wu T-Y 2004. Combustion synthesis of nanocrystalline ZnO powders using zinc nitrate and glycine as reactants—influence of reactant composition. *Journal of Materials Science*, 39:6111 – 6115.

Inamdar AI, Mujawar SH, Ganesan V, Patil PS 2008. Surfactant-mediated growth of nanostructured zinc oxide thin films via electrodeposition and their photoelectrochemical performance. *Nanotechnology*, 19: 325706.

Mahmoud RS, El-Fadl AA, Abu-Sehly AA, Alotaibi BM, Alrowaily AW, Aboraia AM, Shaaban ER 2022. Structural, optical, and magnetic properties of iron-doped ZnO nanoparticles for optoelectronics. *Journal of Materials Science: Materials in Electronics*, 33: 23484–23494.

Mala NA, Dar MA, Sivakumar S, Bhat KS, Sinha GN, Batoo KM 2022. Electrochemical supremacy of cobalt-doped nickel oxide and its supercapacitor applications with its mesoporous morphology. *Journal of Materials Science: Materials in Electronics*, 33:11582–11590.

Mia MNH, Habiba U, Pervez MF, Kabir H, Nur S, Hossen MF, Sen SK, Hossain MK, Iftekhar MA, Rahman MM 2020. Investigation of aluminum doping on structural and optical characteristics of sol–gel assisted spin-coated nano-structured zinc oxide thin films. *Applied Physics A*, 126:162.

Munir S, Asghar F, Younis F, Tabassum S, Shah A, Khan SB 2022. Assessing the potential biological activities of TiO₂ and Cu, Ni and Cr doped TiO₂ nanoparticles. *RSC Advances*, 12: 3856.

Musharaf M, Karamat S, Hassan MU, Khaliq U, Oral A, Behjat AB, Akram R, Almohaimeed Z 2021. Solubility enhancement of Fe in ZnO nanoparticles prepared by Co-precipitation method. *Journal of Superconductivity and Novel Magnetism*, 34: 2633–2642.

Muzaffar SM, Naeem S, Yaseen S, Riaz S, Kayani ZN, Naseem S 2020. Microwave assisted tuning of optical and magnetic properties of zinc oxide nanorods—efficient antibacterial and photocatalytic agent. *Journal of Sol-Gel Science and Technology*, 95:88–100.

Pang H, Gaob F, Lu Q 2010. Glycine-assisted double-solvothermal approach for various cuprous oxide structures with good catalytic activities. *CrystEngComm*, 12: 406–412.

Rahman MYA, Umar AA, Taslim R, Salleh MM 2015. Effect of surfactant on the physical properties of ZnO nanorods and the performance of ZnO photoelectrochemical cell. *Journal of Experimental Nanoscience*, 10: 599-609.



Rajaboopathi S, Thambidurai S 2019. Synthesis of bio-surfactant based Ag/ZnO nanoparticles for better thermal, photocatalytic and antibacterial activity. *Materials Chemistry and Physics*, 223:512-522.

Ravichandran A, Dhanabalan K, Valanarasu S, Vasuhi A, Kathalingam A 2015. Role of immersion time on the properties of SILAR deposited CuO thin films. *Journal of Materials Science: Materials in Electronics*, 26: 921-926.

Ribut SH, Abdullah CAC, Yusoff MZM 2019. Investigations of structural and optical properties of zinc oxide thin films growth on various substrates. *Results in Physics*, 13: 102146.

Şahin B, Aydın R, Cetin H 2020. Tuning the morphological, structural, optical and dielectric properties of hausmannite (Mn_3O_4) films by doping heavy metal lead. *Superlattices and Microstructures*, 143: 106546.

Singh N, Mittal S, Sood KN, Rashmi, K.Gupta P 2010. Controlling the Flow of Nascent Oxygen Using Hydrogen Peroxide Results in Controlling the Synthesis of ZnO/ZnO₂. *Chalcogenide Letters*, 7: 275-281.

Taha AA, Abdel Rahman HH, Abouzeid FM 2013. Effect of Surfactants on the Rate of Diffusion Controlled Anodic Dissolution of Copper in Orthophosphoric Acid. *International Journal of Electrochemical Science*, 8:6744 – 6762.

Taşdemir A, Aydın R, Akkaya A, Akman N, Altınay Y, Çetin H, Şahin B, Uzun A, Ayyıldız E 2021. A green approach for the preparation of nanostructured zinc oxide: Characterization and promising antibacterial behavior. *Ceramics International*, 47 19362–19373.



BARRIERS TO BLENDED LEARNING AMIDST PANDEMIC GRADE 12 STEM STUDENTS AT COLUMBAN COLLEGE, INC.- MAIN

JOHN RALZEN M. SANTIAGO

Education Student, Bachelor of Secondary Education Major in Science
Columban College, Inc.
Olongapo City

Abstract

The COVID-19 virus has dramatically reshaped and altered the global education chronicle on deliberation system. The education sectors face multiple barriers enabling to perform students to their utmost learning capabilities in blended learning modality amidst pandemic. This study converges on attempting to determine occurrences of barriers in learning experience of grade 12 STEM students across blended learning modality. A descriptive quantitative research and a standardized semi-modified survey questionnaire employed in gathering imperative data. The respondents were all Senior High School grade 12 STEM students enrolled at Columban College, Inc. -Asinan, Olongapo City included with 238 participants. The data were measure and evaluate through frequency, percentage, weighted mean, t-Test, and Analysis of Variance (ANOVA).The consequent given data concluded that the overall learning experience of student's-respondents across barriers yields a positive remarks of "all disagreeing" such as follows; a) administration, b)social interaction c) academic skills, d) scientific skills, e) technical skills, f) learner motivation, g) time and support for studies, h) cost and access to internet, and i) face-to-face transition. Furthermore, result interpreted that the (1) respondents-demographic profile has no significant' difference between sex profile and number of digital tool devices used during blended learning. (2) The respondents-demographic profile in terms of digital tool device/s used across barriers to blended learning has no significant variation.

Keywords: Barriers, Online Learning, Blended Learning, STEM, Descriptive research, Pandemic, Olongapo City, Zambales, Philippines



EFFECTS OF FERMENTED ORGANIC CONCOCTION FROM FISH ENTRAILS AND BANANA STEM ON THE GROWTH AND YIELD PERFORMANCE OF TOMATO (*Solanum lycopersicum*) PLANT

Ferlyn Logronio
Anabelle Poloyapoy
Emelor Camingawan
Joliboy Conol
Rosanilio Yagos

Northwestern Mindanao State College of Science and Technology, Labuyo, Tanguib City
J.H. Cerriles State College, Mati, Zamboanga del Norte

Abstract

Synthetic fertilizers used in food production have been linked to several negative effects on the environment and human health. That is why studies and trials to formulate and apply organic fertilizers have lately become eminent. This study formulated a concoction from discarded fish entrails and banana stem. Furthermore, this also sought to evaluate the efficacy of this concoction on the growth and yield performance of *Solanum lycopersicum* plants. Two hundred ten *Solanum lycopersicum* plants were utilized using a Completely Randomized Design (CRD). Seven treatments, using different level of formulation, were established and data like the root length, shoot length, the number and weight of fruits, dry matter, and return of investments were collected and analyzed. Results revealed a highly significant difference in the growth parameters ($p < 0.01$) and in the number and total weight of fruits ($p < 0.05$). The highest dry matter and ROI were obtained in T₂ and T₇. Furthermore, T₇ was the most effective fermented organic concoction because it recorded the highest values of growth and yield parameters of tomato. As a result, the developed mixture is highly recommended for tomato growers as an eco-friendly and long-lasting organic fertilizer.

Keywords: tomato, fermented banana stem, fermented fish entrails, growth, yield



**COMMUNITY STRUCTURE OF FRESHWATER FISHES FROM THE SIBUGAY RIVER,
MINDANAO, PHILIPPINES**

Rosanilio M. Yagos

Chinchin J. Demayo

Cesar G. Demayo

School of Agriculture, Forestry and Environmental Studies, J. H. Cerilles State College, Mati, San Miguel, Zamboanga del Sur, Philippines

Department of Biological Sciences, College of Science and Mathematics, MSU-Iligan Institute of Technology, Iligan City, Philippines

Abstract

This study aimed to evaluate the diversity and distribution of freshwater fishes in Bayog Watershed, Bayog, Zamboanga del Sur, Philippines. A total of 1408 fish individuals were collected, comprising 11 families, 13 genera, and 19 species. Out of the 19 species, 11 were identified as endemic and native, while eight were introduced species. The presence of *Pterygoplichthys disjunctivus* is the most concerning since it would be a possible pest in this area. The two most abundant species comprised 51% of the overall count: *Oreochromis niloticus* (25.99%) and *Barbodes binotatus* (25.5%). Shannon-Weiner's diversity indices calculated for the six sampling sites varied from 1.67 to 2.05 ($H' = 2.04$), which is relatively good. However, the abundance of many introduced species may disrupt the population structures of the native/endemic freshwater species in the different sites. The information generated in this study may serve as one of the bases for different conservation strategies for the fish of the area.

Key Words: Bayog watershed, diversity, freshwater fishes



**AWARENESS AND ACCEPTABILITY OF CAMARINES NORTE STATE COLLEGE
VISION AND MISSION, THE GRADUATE SCHOOL GOAL AND THE OBJECTIVES OF
CURRICULAR PROGRAMS**

Reina A. Mabeza

Nora J. Macasinag

Corazon S. Fajardo

Ma., Faculty, College of Business and Public Administration

Retired Faculty Members

Abstract

This study assessed the respondents' extent of awareness and acceptability of the Camarines Norte State College (CNSC) vision and mission, the Graduate School goal and the objectives of curricular programs. A descriptive research survey was used in the study and employed a structured survey questionnaire in gathering the relevant data from the respondents. The findings revealed that the respondents which also identified as the stakeholders of the CNSC such as the students, parents, faculty members, employees, and alumni are highly aware on the CNSC's vision and mission, the Graduate School goal and the objectives of its different curricular programs. Likewise, the findings revealed that the respondents highly accepted the CNSC mandates, the Graduates School goals and its different curricular objectives. Using One-way Analysis of Variance (ANOVA), results inferred that no significant differences on the extent of awareness of the respondents in terms of CNSC vision, mission, GS Goal and in the objectives of its different curricular programs. The study recommended that an extensive dissemination of the CNSC vision, mission, the Graduate School goal and the objectives of its curricular programs during the beginning of the school term and these must be disseminated sustainably through different fora and to other platform of information like College Webpage, in local TV and radio programs, posted in bulletin boards, flyers and the like.

Keywords: Awareness, Acceptability, Vision, Mission, Goal, Objectives, and Curricular Programs



JOB SATISFACTION AND PERFORMANCE OF GORDON COLLEGE EMPLOYEES: A BASIS FOR AN INTEGRATIVE MODEL OF A RESPONSIVE HR POLICY

Lovelyn P. Ceralde

Darwin P. Paguio

Ediric D. Gadia

Lovelyn P. Ceralde, Student Welfare and Services Office, Gordon College, Olongapo City, Philippines

Darwin P. Paguio, Academic Affairs Office, Gordon College, Olongapo City, Philippines

Ediric D. Gadia, Research Development and Community Extension Services, Gordon College, Olongapo City, Philippines

Abstract

The study explored the effects of job satisfaction to job performance of Gordon College employees. Results of the study will serve as basis for developing an integrative framework of a responsive human resource policy in strengthening the performance of employees. The study utilized the exploratory cross-sectional research design that used universal sampling where ninety-nine (99) teaching personnel where the respondents. It utilized documentary analysis and a survey questionnaire adapted from a study entitled Development and Validation of Job Satisfaction Scale for Different Sectors (Nanjundeswaraswamy in 2019). The data were statistically analyzed using frequency and distribution, weighted mean and Partial Least Square- Structural Equation Modeling. The findings showed that most of the respondents are aged 21 – 30 years old and has stayed at the institution below 3 years. Most of them are satisfied with their jobs in terms of compensation and benefits, work environment, career and promotion opportunities, leadership styles, communication and job clarity, work life balance, training and development and teamwork and job security. Job performance of the teaching personnel based on the result of their performance rating was very satisfactory. However, they have shown poor performance in research and community extension. It is recommended that the institution open more plantilla positions and re-visit the salary grade equivalents of the teaching personnel. The institution must create a healthy research culture and ensure that teaching personnel put a balanced effort into teaching and research. The institution must enhance its criteria for pay increases, promotions, and other advancement that reflect this balance. The institution may improve the policies for incentivizing pay for research production. The “Leading Organizations to Vital Efficiency” Model or the L.O.V.E. Integrative Model is recommended to serve as the frame to create a responsive HR policy.

Keywords: Job Satisfaction; Job Performance; Human Resource Policy; Cross sectional exploratory research design



**DIGITAL LITERACY OF STEM SENIOR HIGH SCHOOL STUDENTS: BASIS FOR
ENHANCEMENT PROGRAM**

Hazel B. Baterna

Teodolyn Deanne G. Mina

Danilo V. Rogayan Jr.

College of Teacher Education, President Ramon Magsaysay State University – San Marcelino,
Philippines

Abstract

Digital literacy promotes students' competitiveness and better opportunity in today's digital world and in the fourth industrial revolution (FIRe). This descriptive-survey research determined the digital literacy of science, technology, engineering & mathematics (STEM) senior high school students. A total of 130 respondents from two state-owned public high schools in Zambales, Philippines answered the digital literacy survey questionnaire. Results revealed that a typical STEM respondent came from school B, aged between 15-17, female and currently Grade 11. The STEM students are digitally literate to some extent in terms of access and evaluation of information; utilization and management of information; media analysis; creation of media products; effective application of technology; and interaction through technology. There is a significant difference in the extent of digital literacy of students when grouped according to sex and grade level. Moderate significant relationship exists across all domain's digital literacy. The study recommends the implementation of the proposed digital literacy working group to enhance students' digital proficiency and to equip them with the challenges of the FIRe. Teachers may likewise utilize digital devices and information effectively and responsibly towards developing digitally literate citizens.

Keywords: Digital citizenship, Digital literacy, Enhancement program, Senior high school, STEM



MARKET DEMAND AND INTEREST PROFILING OF CEBU INSTITUTE OF TECHNOLOGY-UNIVERSITY STUDENTS IN THE ONSET OF ONLINE LEARNING

Rafaeliza P. Diano

Mark Anthony N. Polinar

Alein B. Navares

Erlyn Ivy O. Rago

Cebu Institute of Technology – University

Abstract

This research was undertaken to understand the different customer segments of the Cebu Institute of Technology- University using demographic, geographic, and socio-economic lenses. At the same time, this study also determined the students' technological capacity, technical capability, and willingness to enroll in the University's second summer term of 2020. The study used a descriptive research method to obtain data from 2,133 college students as the respondents using random sampling. Based on data gathered from the six colleges of the University, from first- to fifth-year levels, the closure of schools led them to go back to their provinces, resulting in the geographic distribution of respondents, with 48% situated outside of Cebu City. Moreover, one of the most significant impacts of the pandemic is the decline of combined household income from a mean of P34, 591.22 pre-pandemic to P23,923.85 during the pandemic when community quarantines were still enforced. Additionally, 72% of respondents have limited to moderate internet connectivity, sourced majorly from mobile data at 66% and personal or family-owned Wi-Fi at 50%. Widely used devices used at home were mobile phones at 97% and laptop computers at 56%. Recommendations included providing financial support through university-based and third-party programs and conducting marketing initiatives targeting the higher-income class to cushion the global economic crisis's negative financial impact.

Keywords: Covid-19, student enrollment, online learning, market demand, Cebu institute of technology- University

INTRODUCTION

At the near end of 2019, the world saw the beginning of what became one of the most historic pandemics recorded in our time – COVID-19. In most people, symptoms can include mild to moderate respiratory illness which does not require special treatment. In some cases, however, the infected person may become seriously ill which may require medical attention. Since the virus can spread through small liquid particles when people cough, sneeze, speak or breathe, wearing properly fitted masks, practicing proper hand-cleaning, and social distancing was widely practiced before the advent of vaccines (WHO, n.d.). The goal was to slow down the transmission so quarantine guidelines were observed in the Philippines and all over the world to flatten the curve and lessen the risk of infection and death. Globally, over 600,000,000 confirmed cases have been reported with a death toll of over 6,000,000 as published by the World Health Organization as of November 2022.

Since 2019, COVID-19 has affected several aspects of day-to-day life especially the aspects of healthcare, society, and the global economy. The health sector was greatly challenged especially at



the beginning of the pandemic in terms of diagnosis, quarantine, and treatment of patients. Medical systems were overloaded, and medical professionals were put at serious risk of getting infected. Because of movement restrictions, the normal distribution and availability of goods and services were disrupted, causing not just undue stress but also the closure of businesses such as theatres and restaurants. As a result of no movement and ultimately unemployment, there was poor cash flow in the market, less manufacturing activity, and slow revenue growth (Haleem et al., 2020).

Subsequently, with the worldwide effort to slow down the transmission of the virus, COVID-19 led to the closure of schools and educational institutions worldwide. Reportedly, 220 million higher education students worldwide have experienced learning disruptions. To continually operate and provide education to students, schools and universities transitioned to online learning in the Academic Year 2020-2021. While some schools in other parts of the world may have some form of online education pre-pandemic, moving all instructional materials and conducting fully online programs proved more challenging (Zheng et al., 2021).

In a study on the Impact of the Covid-19 Pandemic on the Education System, universities in India needed to conduct classes by adopting an online teaching methodology through the use of learning management systems and open-source digital learning solutions. Higher education is a determinant of economic development, and the higher education sector was badly hit by the pandemic. India has been a provider of international students to universities in Asia and around the world, with the closure of universities in the country, it was expected that the demand for international higher education will also reduce (Tarkar, 2020)

A few of the challenges raised regarding the closure included the availability of computers and connectivity equipment at home to support online classes. Some universities also do not have enough infrastructure or systems to facilitate online teaching. Questions on the delivery of subjects such as arts, music, and those requiring laboratories also surfaced. The issue of assessment and evaluation also looked challenging as students and faculty, alike, are at first uncertain about how to administer projects, assignments, and other learning assessments. In addition, students with less capability to attend online classes may suffer a clear disadvantage during assessments which may affect their grades. The delivery of school support and services needed to be established to ensure the overall safety and well-being of students and staff, provide clear directions and guidelines in the conduct of classes and school operations, and provide emotional and mental health support. Moreover, a committee needed to be formed to make informed decisions, assess, and learn from the critical situation to overcome and rise to the challenges brought about by COVID-19 (Sahu, 2020)

Moreover, the impact of COVID-19 on education may not be equal across all learners. In developing countries, the lack of infrastructure and access to computers led to the low learning motivation of students coming from poor and digitally-illiterate families. Schools and the government from these countries needed to establish a plan to scale educational technology, using free online sources, and scale up ICT infrastructures (Seble, et al., 2020)

The date was March 23, 2020, when CIT University was forced to close its gates by order of former Cebu City Mayor Edgardo Labella. The University responded to the crisis by forming a group that outlined the framework, which was later introduced as MADE4Learners Framework, and issued a memorandum on the work-from-home set-up for its faculty and administrative personnel and online learning for its students.

CIT University is a private, non-sectarian academic institution built in 1946 to help the country rise from the ravages of World War II. The following degree programs were primarily offered: Civil Engineering, Mechanical Engineering, Electrical Engineering, Chemical Engineering, Architecture,



and Vocational Programs. Over 75 years later, CIT University remains a top producer of highly competent engineering graduates and industry-preferred professionals. Staying true to its tagline, "CIT Tops Again," it has produced more than 80 first placers and over 700 topnotchers from different fields of discipline, with a significant majority coming from the College of Engineering and Architecture (CIT University, n.d.). For the last 75 years, it has relied on face-to-face and onsite operations to educate its students and serve its stakeholders. The transition to remote education and work set-up posed a significant challenge for the University.

Due to this crisis in the delivery of instruction under strict quarantine guidelines, a Crisis Management Group was formed to outline the procedures and policies concerning online promotion, online enrollment, online delivery of education, online communication platforms, learning management system, and the financial aspects of all the mentioned undertakings. The Crisis Management Group was headed by no less than CIT University's University President, together with the following members: the Dean of the College of Computer Studies, the Dean of the College of Nursing and Allied Health Sciences, the Quality Assurance Officers, the Human Resource, Finance, and Marketing Directors. The policies and frameworks developed by the Crisis Management Group allowed CIT University to implement a fully online system which included a work-from-home set-up for its employees and the online education platform called Multiple Approaches to Distance Education, which was developed and later on dubbed Multiple Approaches to Delivering Education for Learners or MADE4Learners.

Having put up the online system was only the beginning. The other challenge is ensuring that the product developed under the MADE4Learners Framework fits the present profile and capacity of CIT University's students and their families. COVID-19 and the guidelines that came with it badly affected the global economy beyond anything it has experienced for the last 100 years. It was estimated that the pandemic could decrease global economic growth by 3% to 6% by the end of 2020 (Wang et al., 2021).

For educational institutions, its products are the academic programs delivered through its teachers' services through instructional delivery platforms. To stay relevant to the customers, CIT University must ensure that its academic program remains of top-notch quality and, at the same time, accessible to its current and potential customers.

The customer is any person who avails of the goods or services offered by any business or institution (Cambridge Dictionary, n.d.). Different companies serve different customers. This is the reason why identifying and understanding the customer is crucial. In a world that has become overly competitive, companies must be able to identify customer segments to survive and thrive. Superior goods and services are no longer sufficient to satisfy customers who have become highly critical. The strategy of mass marketing no longer works in the 21st century. Instead, marketers are now aggressively studying and serving markets with clearly identified needs, wants, and capacities. Segmentation-based marketing is now the core of corporate strategy and value creation (Weinstein A, 2004).

In light of the COVID-19 crisis that has largely affected CIT University and all other academic institutions across the globe, the University needed to look deeper into the changes in the customer landscape and segments to continue offering services that are valuable and accessible. To do this, the University must be able to identify its customers from a demographic, geographic, and socio-economic standpoint. At the same time, it should be able to understand the learners' and their families' capability and capacity to take part in the school's online learning system, the MADE4Learners Framework.

RESEARCH OBJECTIVE



This study was undertaken to understand the customer segments of Cebu Institute of Technology-University using demographic, geographic, and socio-economic lenses. At the same time, this study also determined the college students' technological capacity, technical capability, and willingness to enroll in the University's second summer term of 2020. Moreover, the Marketing and the Business Development Offices of the University utilized the study's findings as an intervention to the barriers identified by college students that hindered them from not enrolling in the term specified.

METHODOLOGY

In understanding the various customer segments and capacities, the study employed a descriptive research method as it is the appropriate methodology to identify characteristics, frequencies, trends, and categories (McCombes, 2022). The Cebu Institute of Technology- University, located at Natalio B. Bacalso Avenue, Cebu City, was the study's environment. With the approval of the University President, a total of 2,133 college students took part in the survey through an online platform using simple random sampling. These respondents were college students from first-year to fifth-year of different programs in the university, such as the college of engineering and architecture (CEA), college of management, business, and accountancy (CMBA), college of arts, science, and education (CASE), college of computer studies (CCS), and college of nursing and allied health science (CNAHS). The researchers crafted a self-made questionnaire to achieve the stated research objectives. Also, the self-made questionnaire was undergone a content validity test in which two (2) professionals or specialists were chosen to serve as the content validators. Lastly, for the data analysis, the study used descriptive analytics such as mean, median, mode, and frequency distribution to examine the collected data properly.

RESULTS AND DISCUSSION

DEMOGRAPHIC and GEOGRAPHIC PROFILE OF RESPONDENTS

Table 1. Profile of Respondents (n = 2133)

Profile	Frequency	Percentage
I. College Representation		
College of Arts, Sciences, and Education	207	10
College of Computer Studies	155	7
College of Engineering and Architecture	1406	66
College of Management, Business, and Accountancy	250	12
College of Nursing and Allied Health Sciences	115	5
II. Year Level		
1st Year	435	20%
2nd Year	770	36%
3rd Year	427	20%
4th Year	136	6%
5th Year	365	17%
III. Gender		
Male	1103	52%
Female	1011	47%



IV. Present Location		
Cebu City	782	37%
Within Cebu Province (BUT not in Cebu City)	1031	48%
OUTSIDE Cebu	320	15%
V. Income Post Pandemic		
₱ 20,000 per month or below	968	45%
₱ 21,000 - ₱ 40,000 per month	703	33%
₱ 41,000 - ₱ 60,000 per month	256	12%
₱ 61,000 - ₱ 80,000 per month	103	5%
₱ 81,000 per month or above	103	5%
VI. Income During the Pandemic		
₱ 20,000 per month or below	1451	68%
₱ 21,000 - ₱ 40,000 per month	424	20%
₱ 41,000 - ₱ 60,000 per month	135	6%
₱ 61,000 - ₱ 80,000 per month	57	3%
₱ 81,000 per month or above	66	3%

The survey had a total of 2,133 respondents, with 66% coming from the College of Engineering and Architecture, 12% from the College of Management Business and Accountancy, 10% from the College of Arts, Sciences, and Education, 7% from the College of Computer Studies, and 5% from the College of Nursing and Allied Health Sciences. These students belong to different year levels, with 56% coming from the first and second years, 26% from the third and fourth years, and 17% in the fifth year. Regarding gender distribution, 52% are male, while 47% are female. When the survey was undertaken, 1,031 or 48% of the respondents were living within Cebu Province but not in Cebu City, 782 or 37% were residing in Cebu City, and the remaining 15% were outside Cebu Province.

SOCIO-ECONOMIC PROFILE AND COVID-19 FINANCIAL IMPACT

Before the enhanced community quarantine triggered by the COVID-19 pandemic, the respondents had an average estimated monthly income of P34,591.22 with a median income of P25,000. Forty-five percent or 968 of the respondents' families had a combined income of P20,000 or below per month, while 33% had a combined income of P21,000 to P40,000. Only 22% recorded a combined monthly income of P41,000 and up. This means that the respondents are already within the lower-middle income class and pre-pandemic, using the average combined monthly income and median income. In terms of proportion, 78% belong to the poor to lower middle-income classes, while 22% belong to the middle-income class or higher.

During the pandemic, however, restrictions on movement that heavily affected the economy were enforced all over the country. This decreased the respondent's income to P23,923.85 per month, with a median of P18,000. In terms of proportion, 68% of families recorded a combined monthly income of P20,000 or below, while 20% are a P21,000 to P40,000 income per month. This reduced the income classes of the respondents to a level lower than pre-pandemic.

TECHNOLOGICAL CAPACITY AND CAPABILITY

CIT University's MADE4Learners included multiple approaches to delivering education to students interested in continuing their education despite the pandemic. These approaches included Distance,



Distance-Blended, and Online-Blended. Though not similar in synchronous and asynchronous schedules, all approaches required technological devices and technical support tools to deliver quality education effectively. Figure 2 shows the different approaches, device requirements, and technology support tools specified under CIT University’s MADE4Learners Framework.

	APPROACH 1 Distance (Offline)	APPROACH 2 Distance-Blended (Offline-Online)	APPROACH 3 Online-Blended (Online-Offline)
WHAT DO I NEED? Device Requirement	GOOD SMART PHONE BETTER TABLET BEST LAPTOP/DESKTOP	GOOD SMART PHONE BETTER TABLET BEST LAPTOP/DESKTOP	LAPTOP/DESKTOP
HOW OFTEN? Asynchronous vs Synchronous	10% synchronous (estimated at 1 hour per week plotted time). Communication may happen asynchronously through online message threads, discussion boards, chats, emails.	30% synchronous - may be used for synchronous videocon-lectures, quizzes, live chats and discussions. Communication may happen asynchronously through online message threads, discussion boards, chats, emails.	50-60% synchronous- may be used for synchronous videocon-lectures, quizzes, live chats and discussions. Communication may happen asynchronously through online message threads, discussion boards, chats, emails.
Technology Support Tools	<ul style="list-style-type: none"> Moodle (required) Facebook group Messenger 	<ul style="list-style-type: none"> Moodle (required) Facebook group Messenger Jit.si/Zoom 	<ul style="list-style-type: none"> Moodle (required) Facebook group Messenger Jit.si/Zoom

MADE4Learners Framework | Email info@cit.edu for more details.

Figure 2. MADE4Learners Framework One-Pager

Based on the data gathered, 72% of the respondents have limited or moderate internet connectivity, 20% have high internet connectivity, and 9% reportedly have no connectivity.

Table 6. Internet access/connectivity of respondents

Internet access/connectivity		
Response	Frequency	Proportion
FULL internet access / HIGH internet connectivity	416	20%
LIMITED internet access / MODERATE internet connectivity	1529	72%
No Internet Access/No Internet	188	9%
Total	2133	100%

Widely used connectivity sources included mobile data at 66% and family-owned Wi-Fi at 50%.



Table 7. Source/Type of Internet Connection at Home

Source/Type of internet connection at home		
Source/Type of Internet Connection	Frequency	Proportion
Broadband	506	24%
Personal (or family-owned Wi-Fi)	1075	50%
Shared Wi-Fi	589	28%
Mobile Data	1411	66%
Others	130	6%

In terms of Internet Service Providers, Globe recorded 49% subscriptions while PLDT/Smart was 41%.

Table 8. Internet Service Provider Subscription

Internet Service Provider Subscription		
Response	Frequency	Proportion
Converge IT Solutions	6	0%
Globe	1047	49%
One Sky	55	3%
Rise	0	0%
PLDT/SMART	882	41%
Others	232	11%

Since the device is also a factor in the successful delivery of online or distance learning, respondents were also asked about the devices they presently had to access the internet and pursue MADE4Learners. Two thousand, seventy-seven or 97% had mobile phones, 56% had laptop computers, and 30% had desktop computers or tablets.

Table 9. At-home Devices for Connection and Learning

At-home Devices for Connection and Learning		
Device to access the internet	Frequency	Proportion
Desktop Computer	398	19%
Laptop	1193	56%
Mobile Phone	2077	97%
Tablet	238	11%
Others	114	5%

With the guidelines provided in the MADE4Learners one-pager, it can be seen that the three approaches catered to the different connectivity levels and devices available to the students at the time.

ONLINE EDUCATION READINESS LEVEL

Table 10 shows the overall readiness level of the college students who participate in the study. The respondents rated 2.82, which is interpreted as high. The readiness level was rated based on the following aspects: self-direction at 2.85 or high, learning preferences at 2.78 or high, study habits at 2.74 or high, technical skills at 2.90 or high, and course communication at 2.87 or high.



Table 10. Summary of the Aspects of Online Education Readiness Level

Online Education Readiness Level		
Aspect	Average	Interpretation
Self-Direction	2.8519	HIGH
Learning Preferences	2.7764	HIGH
Study Habits	2.7425	HIGH
Technical Skills	2.8941	HIGH
Course Communication	2.8686	HIGH
CIT Overall Readiness Level	2.8242	HIGH

Legend: 4.0 – 3.26 Very High
 3.25 – 2.51 High
 2.50 – 1.76 Low
 1.75 – 1.0 Very Low

In terms of self-direction, the respondents rated themselves high across five aspects, including goal setting, time management, and project completion. In terms of learning preferences, the respondents rated the aspects high except for the item on not having face-to-face interaction with peers and professors. All other items, including learning with minimal assistance and learning from videos, podcasts, and others, were also rated high. As for study habits, the respondents rated low on being able to ignore distractions and spending 10-20 hours on an online course. Other aspects, such as keeping a record of assignment dues and being able to turn in assignments on time, are all high. In terms of technical skills, the willingness to use e-mails, social media platforms, and other online tools to submit outputs was rated very high. The comfort level in surfing the internet, researching, downloading files, and changing computer settings was rated high. However, knowing where to find help with computer problems was rated low. Regarding course communication, all aspects, including communicating via social media or SMS and the comfort level in seeking assistance from instructors or classmates, were all rated highly.

In the Philippines, the challenge brought about by internet connectivity brings a lot of disadvantages to online learners. The inconsistent connectivity compromises the quality of education, especially with synchronous classes which require a high-speed internet connection and more bandwidth. In a study done at Misamis University, poor internet connection was considered to be the main problem for both learners and teachers in the conduct of online classes as it affects attendance, lesson continuity, performance, output submission, and communication. (Clarín, et.al., 2022)

In a study by Plews (2017), respondents enumerated (a) awareness of learning preference, (b) seeing oneself as technology-savvy, and (c) being focused on the goal as factors critical to online learning. Being aware of one's learning preference increases the ability and desire to engage in autonomous learning. Being technology-savvy increases self-efficacy when using tools for education. Additionally, it was found that students who had more learning strategies had higher levels of motivation in their online classes. Moreover, students with higher levels of technology self-efficacy earned better grades (Wang, 2013). A pilot study conducted at the National University of Tainan further showed a significant positive relationship between self-directed learning abilities and online learning performance as a result of a criterion test with engineering students (Chou, 2012)

In Ireland, it was found that students from the poorest broadband coverage area also are most likely disadvantaged from a socioeconomic standpoint. With this chasm in terms of internet connectivity also comes the digital divide in terms of access to devices and equipment such as laptops or desktop



computers. This led to recommendations that included the prioritization of campus facilities that provide internet access and services to financially challenged students living in low broadband geographies (Cullinan, 2021).

ENROLLMENT STATUS AND INTENTION TO ENROLL

Given that the first summer term had already started when the survey was conducted, several respondents were already enrolled in the first summer term. Of the 2,133 respondents, 45% were enrolled, while 55% were not. Out of the 954 who were enrolled in the first summer term, only 57% planned on enrolling for the special or second summer term. Out of the 1,179 who were not enrolled in the summer term, only 23% expressed their intent to enroll in the special or second summer term.

Below is the probability diagram that visualizes the intention of students to enroll in the next term.

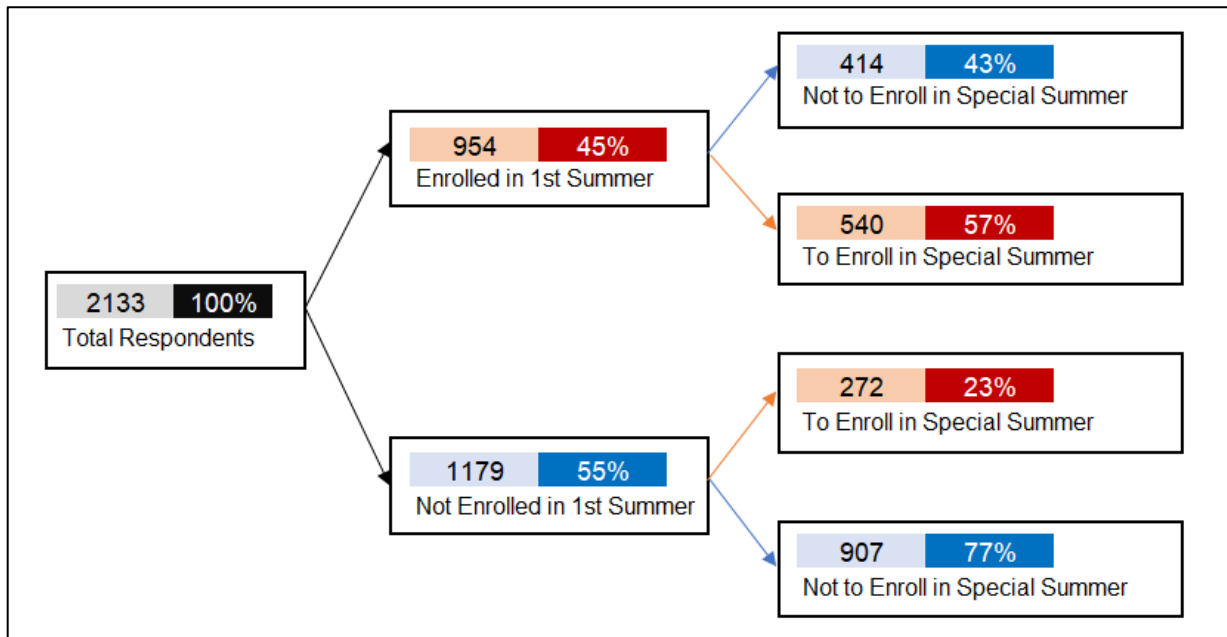

Figure 3. Probability Diagram of Student Distribution in Terms of First Summer Term Enrollment and Intention of Enrollment in the Special or Second Summer Term

CONCLUSION

The COVID-19 pandemic led to the closures of schools all around the world. With this, educational institutions must be resilient and design academic and administrative frameworks to ensure business and learning continuity. CIT University introduced the MADE4Learners framework to respond to the challenge of movement restrictions and health threats. The university was one of the first in the country to announce and implement the online learning format during the pandemic.

Based on data gathered from student-respondents from the six colleges of the University, from first to fifth-year levels, the closure of schools led them to go back to their provinces, resulting in the geographic distribution of respondents, with 48% situated outside of Cebu City. Moreover, one of the greatest impacts of the pandemic is the decline of combined household income from a mean of P34,591.22 pre-pandemic to P23,923.85 during the pandemic when community quarantines were still enforced.



The MADE4Learners framework was initially designed to have three approaches: distance, distance-blended, and online-blended. These approaches have different levels of device requirements, synchronous contacts, and technical support tools. Based on data gathered, 72% of respondents have limited to moderate internet connectivity, sourced majorly from mobile data at 66% and personal or family-owned Wi-Fi at 50%. Widely-used devices used at home were mobile phones at 97% and laptop computers at 56%.

Despite these, only 812 students, or 38% of the total respondents, expressed their intent to enroll in the special or second summer term.

RECOMMENDATIONS

After the organization, presentation, and analysis of the data gathered, the action plans below are hereby recommended:

1. Financial Support. The high probability of attrition is primarily caused by the negative financial impact of the movement restrictions caused by the COVID-19 pandemic. To aid students, the university may offer the following financial assistance:
 - a. Offer deferred payment programs to allow students to enroll and pay dues at a later date.
 - b. Provide longer credit terms to give students and their parents ample time to look for sources of funds to pay tuition and other dues.
 - c. Tap on third-party loan providers and other financial institutions to offer loans to financially challenged students.
 - d. Offer virtual non-academic scholarship set-up to continue supporting non-academic scholars
 - e. Look for alumni and industry partners who are willing to support more students even during a pandemic.
2. Market Segmentation and Targeting. A strategic plan to attract students from upper-level income classes can be undertaken to cushion possible attrition. This move will lessen price sensitivity and cushion the negative effect on enrollment and retention in the event of a national or global recession or financial crisis.

REFERENCES

- Chih-Hsuan W., David M. Shannon & Margaret E. Ross (2013) Students' characteristics, self-regulated learning, technology self-efficacy, and course outcomes in online learning, *Distance Education*, 34:3, 302-323, DOI: [10.1080/01587919.2013.835779](https://doi.org/10.1080/01587919.2013.835779)
- Clarín, R., Baluyos, L. Challenges Encountered in the Implementation of Online Distance Learning. *EduLine: Journal of Education and Learning Innovation* ISSN: 2775-6173 (online) Vol. 2 No. 1 (2022) <https://doi.org/10.35877/454RI.eduline591>
- Haleem A, Javaid M, Vaishya R. Effects of COVID-19 pandemic in daily life. *Curr Med Res Pract.* 2020 Mar-Apr;10(2):78-79. doi: 10.1016/j.cmrp.2020.03.011. Epub 2020 Apr 3. PMID: 32292804; PMCID: PMC7147210.



- Plews, R. Self-Direction in Online Learning: The Student Experience. *International Journal of Self-Directed Learning* Vol 14, No. 1 (Spring 2017)
- Sahu P (April 04, 2020) Closure of Universities Due to Coronavirus Disease 2019 (COVID-19): Impact on Education and Mental Health of Students and Academic Staff. *Cureus* 12(4): e7541. doi:10.7759/cureus.7541
- Seble, T., Worku M., The Impact of COVID-19 Pandemic on the Education System in Developing Countries: A Review. *Open Journal of Social Sciences* Vol. 8, No. 10 (October 2020)
- [Tarkar, P. Impact of COVID 19 Pandemic on Education System.](#) *International Journal of Advanced Science and Technology* Vol. 29, No. 9s, (2020), pp. 3812-3814
- Wang, C., Wang, D., Abbas, J., Duan, K., Mubeen, R. Global Financial Crisis, Smart Lockdown Strategies, and the COVID-19 Spillover Impacts: A Global Perspective Implications From Southeast Asia. *Frontiers in Psychiatry* 12 (2021).
<https://www.frontiersin.org/articles/10.3389/fpsy.2021.643783>.
DOI=10.3389/fpsy.2021.643783
- Weinstein, A., *Handbook of market segmentation: strategic targeting for business and technology firms* / Art Weinstein. —3rd ed (2004). The Haworth Press, New York
- Zheng, M., Bender, D. & Lyon, C. Online learning during COVID-19 produced equivalent or better student course performance as compared with pre-pandemic: empirical evidence from a school-wide comparative study. *BMC Med Educ* 21, 495 (2021).
<https://doi.org/10.1186/s12909-021-02909-z>



THE COMPANY’S DIGITAL CREATIONS: LEGAL ISSUES AND CHALLENGES

Chahid Slimani

Samah Bouhazama

Professor at Law School, Sidi Mohamed Ben Abdellah University, ESSOR Lab, Fez, Morocco
Faculty of Social, Economic and Law Sciences, Sidi Mohamed Ben Abdellah University, BP 42 A,
Fez, Morocco

Ph D student at Law School, Sidi Mohamed Ben Abdellah University, ESSOR Lab, Fez, Morocco
Faculty of Social, Economic and Law Sciences, Sidi Mohamed Ben Abdellah University, BP 42 A,
Fez, Morocco

Abstract

Today the majority of company’s creations involve a digital dimension. In this context, legal protection of digital creations is now a significant asset for companies that attempt to overcome physical limits and move toward digitization. Indeed, one of the priority issues for companies is the legal uncertainties affecting the digital creations. In this framework, intellectual property law serves as a tool for businesses to protect their digital creations. However, as they currently stand, intellectual property rules can paradoxically be a source of economic inefficiency and legal uncertainty in the digital economy eventually leading to infringement of companies’ digital creations. Therefore, in order to preserve their digital creations, businesses are increasingly turning to blockchain technology. The blockchain is becoming increasingly usable, particularly in the field of intellectual property, because it can help prove the precedence of rights, prove companies' rights to digital creations, and ensure transaction traceability. To date, we have seen several cases of the technology of blockchain being used in intellectual property. This decentralized technology, which exists throughout the world outside of any general structure or public entity, captivates the curiosity of companies. A debate on the legality of the benefits provided by blockchain to company’s digital creations is required.

Key words: Digital creation; Software; Website; Blockchain; Legal Proof

Introduction

In the digital world, to exist means to be visible. The challenge of a company’s visibility is major and its digital creations are at the heart of this issue. The challenge is to harmoniously combine the real world and the digital world by keeping company’s creations at the heart of the protection system.

The majority of creations produced today within companies include a digital dimension. For businesses, looking to overcome physical limitations and make the transition to digitalization, the legal protection of digital creations is now a significant advantage.

However, rules as they exist today can paradoxically be a source of economic inefficiency and legal uncertainty in the digital economy which can lead to a violation of the company’s digital creations.

In order to preserve their digital creations, companies are increasingly turning to blockchain technology. Blockchain technology is particularly well-liked in the context of intellectual property, in this case, digital creations, as it might make it easier to demonstrate the antecedency of rights, permit the demonstration of rights on creations, and guarantee the traceability of transactions.



We have already observed a number of instances of the growing blockchain being used in intellectual property. Companies are interested in this decentralized technology since it exists globally independent of any general framework and public institution. Therefore, a debate about the risks and advantages of the blockchain is required.

I. The Legal protection of companies' digital creations

I.1. The legislative framework for digital creation in Morocco

Law No 2-00 on copyright and related rights is the source of copyright in its current form. According to its Article 2: “Every author enjoys the rights provided in this Law over his literary and artistic creation. The protection resulting from the rights provided in the preceding paragraph as from the creation of the content, even if it is not fixed on a material medium.”

The concept of digital creation does not exist in positive law. Yet in practice it covers an omnipresent reality. The majority of creations produced today in companies include a digital dimension. Even the most traditional creations are now exposed to the world of interactivity. For example; a text will be enriched by links to other digital content (Gelles & Poidevin, 2015).

To be more precise, the digital content includes the database, audiovisual creation, and software creation, to get closer to what is also called the multimedia creation.

The digital creation cannot be confused with the software creation, even if, for example, a website can only be created and accessed using software tools, insofar software remains instruments and not the purpose pursued by the creator.

The concept is also similar to the database, defined in Article 1 of Law 2-00 as: «Any collection of creation, data or other independent elements, to dispose in a systematic or methodical way and individually accessible by electronic means or any other way».

Insofar as the website provides content presented as a set of elements to which the user can access according to the navigation principles adopted by the creator of the site concerned, it constitutes a database within the meaning of the prementioned article of the law 2-00 on copyright and related rights.

The digital creation also incorporates some traits from the audiovisual art by offering textual components coupled with audio and visual components.

In short, a digital creation can be defined as any creative content incorporating on the same medium one or more of the following elements: text, sound, images, moving images, computer programs, whose structure and access are governed by software allowing interactivity (SNE, 1994).



I.2. The legal protection of the software and website

The issue is that there is currently no legal framework specifically for digital creation; instead, they borrow their protections from other sorts of creations we have mentioned, such as software creations, databases, and websites.

Industrial logic underlies its style of production on the one hand, and writing-based form creation on the other. The oscillation is also conceptual, since the copyright in question is a very specific right (Macrez, 2011).

Applied to the software, it can without abuse be qualified as a right close to the patent right. In this sense, the software lies between patent and copyright.

But the truth is that software can be considered a creative endeavor, be covered by copyright laws, and be a patented invention. Computer programs are now included in the list of content that are protected by copyright in Morocco by Law No 2-00 on copyright and related rights, as revised and expanded by Law No 34-05 and Law No 72-12 (Schimdt-Szalewski & Pierre, 2007).

The Law on Literary and Artistic Property does not specify that in order to benefit from copyright protection, the software must have an original character. Nevertheless, this condition derives from the very principles of literary and artistic property. So only software with an original character is protected by copyright.

The criterion of originality is the only substantive condition necessary for the protection of the software by copyright (Pignatari & Cousin, 2016). But in the absence of a legal definition, doctrine considers that content can only be protected when it bears the imprint of the personality of its author.

However, this condition, which is not very suitable for software, has evolved. Indeed, the software can be protected if its source code bears the mark of the intellectual contribution of its author. Originality must therefore be understood as a personalized effort going beyond the simple implementation of an automatic and constraining logic and the materialization of this effort lies in an individualized structure. Originality is appreciated in terms of the author's own design choices.

Only the literal and mathematical expressions of the programs that form the software's base are protected by it; ideas are not protected. These concepts cannot be copyrighted; only their formatting can. In other words, the content is the author's materialization. Sometimes they are integrated into household appliances or cars, but usually they are inserted into physical media such as a CD or USB key. Since software can sometimes be used to monitor a network, it should be noted that it is the part of the software that is the subject of protection. Everything also depends on how the software is utilized. Therefore, it's critical to understand how its program affects a device's operation in order to better protect it (Fauchoux et al., 2013).

Algorithms are a must when approaching software. They are a critical element of the capital of some companies investing in the exploitation of digital data and they should be protected. However, because they are an immaterial creation, their protection is limited at least.

The algorithm is a concept in mathematics. It belongs to the category of concepts, which cannot be protected. In practice, algorithms are made and included in software's source code (Boizard, 2018). As mentioned above, software is protected by copyright as long as it has originality. With regard to algorithms, the originality condition will be difficult to prove as illustrated by a judgment of the French Court of Cassation of 14 November 2013. A publisher was acting in forgery against Microsoft Corporation for copying accounting software he had designed. The Court ruled against infringement because of the lack of evidence to justify the originality of the software, such as programming lines, codes or organization chart, or preparatory design material. This decision



highlights the point of the limit of copyright protection that does not protect the software as a whole: the functionalities of software are not protected.

The final and schematic view of the software landscape is shown below. On the one hand, there is a copyright that has been given a very precise legal framework and qualification condition inside the copyright's broad terms. On the other hand, a patent that has been improperly granted, or at the very least according to a legal interpretation, may be significantly contested, particularly before a judge. In other words, *sui generis* copyright and patent contract *legem*, assumed to be valid (Macrez, 2011).

The Internet presents significant challenges for copyright lawyers. Online games, websites, and other creations are only a few examples of the many creative content that the Internet inspires (Azzi, 2011). This raises the question of the means of protecting these new riches. We will therefore focus on how to protect databases by taking the example of websites.

Law No. 2-00 on copyright and related rights in its third article lists a list of creations considered to be content of the copyrighted spirit. Although not expressly covered by this text, the website may be protected by copyright under certain conditions.

The website may be protected by copyright in various ways. Its title, first of all, can be, under the same conditions as the titles of other content. In terms of content, the website is then animated by software that deserves legal protection. The creation still contains texts, images and sounds that are elements that can be protected. When the site is not viewed as a whole, the same holds true for the database or databases that the site consists of. The website also provides hypertext links, which can be viewed as objects of rights and are likely to violate copyright by enabling unauthorized downloading. The fact that these websites have been called "hubs of rights" should not come as a surprise (Vivant & Bruguere, 2012).

On the content and architecture of the website, it can benefit from copyright protection insofar as its presentation and its various elements: a page-screen, a graphic, an animation has enough originality to claim this protection of the works of the spirit.

It should be highlighted that while copying some website elements is illegal because they violate copyright laws, copying other elements is acceptable since, when examined separately, they do not violate copyright laws. Technical elements are not covered by copyright protection.

Moreover, the simple concept of a website is not protected by copyright. Ideas are free-ranging and cannot in any way be appropriated (Mattatia, 2021).

As long as they are original, creations of the spirit are protected. This originality is characterized as the author's expression of their creative ability through their use of personal freedom. As a result, if a website only allows users to complete areas (like a Facebook profile) it cannot receive this protection because it lacks originality.

II. Illegal acts relating to the company's digital creations.

Several illegal acts are likely to harm the company's digital creations. We will limit ourselves to counterfeiting and piracy.

Counterfeiting is usually defined as the fraudulent imitation or manufacture of a thing to the detriment of the person who alone had the right to manufacture or reproduce it (Azddou, 2018). In particular, in the field of intellectual property, counterfeiting has been defined as any infringement of a literary, artistic or industrial right of ownership (reproduction, imitation, sale, offer for sale, etc.).

In fact, according to Law No. 17-97, as amended and supplemented by Law No. 23-13 any violation of the rights of the owner of an invention patent, an integrated circuit layout-design (topography), a



registered industrial design, a registered trade mark, trade mark or service mark, or a registered geographical indication or designation of origin constitutes an infringement.

There are multiple instances of counterfeiting of parts on the internet that are covered by intellectual property law in current case law, including abuse of hyperlinks, resumption of graphic charters of websites, and duplication of third-party graphic elements.

The following example shows the case of the managers of a company that had plagiarized the website of a real estate advertising company, reproducing “in particular its logo with stars and all the sections (...), the exact wording of its advertisements in certain free newspapers and also commercial documents: brochure, instructions for use, distribution contract, Descriptive Record of the Property, and also the Commercial Book in all identical respects,” were sentenced for infringing copyright on the site and on the documents, as well as for trademark infringement, to penalties and damages. However, the website that assigns a competitor for counterfeiting must demonstrate the originality of its site under penalty of being rejected¹.

In Morocco, the adoption of Law No. 2-00 on copyright and related rights and Law No. 23-13 amending and supplementing Law No. 17-97 on the protection of industrial property, provides a mechanism for the judge to ensure protection, like comparative law and in accordance with the recommendations of multilateral organizations, including, for the first time, content of a computer nature or available on the network.

Our main interest in these laws is in the texts relating to civil and criminal sanctions and digital crime.

On the one hand, it can be inferred from the interpretation of Law 17-97 on the protection of industrial property that the outcomes of an action for infringement vary depending on whether it is a civil action or a criminal action for infringement. When a trademark is violated, the criminal action results in a prison sentence of three months to a year and a fine of 100,000 to one million dinars, or just one of these two sentences.

Additionally, the crime of copying includes a term of two to six months in prison, a fine of 50,000 to 500,000 dirhams, or only one of these two penalties. There is an additional punishment for counterfeiting, which is the destruction of the counterfeiter's own items that have been identified as being counterfeit as well as any instruments or methods used to make the counterfeit.

Regarding the civil action, it enables the claimant to reclaim his full ownership of his trademark and make reparations for the damage intended. In the event of infringement, the organization may elect to take unfair competition-related action to compensate for the specific infringement-related activity and may only raise the risk of uncertainty that it experiences as an unfair competition-related aspect.

On the other hand, Law 2-00's civil and criminal penalties for violating copyright and associated rights are extensive, yet generally speaking, piracy continues to be the most widespread. Penalties are dealt with in Law 2-00, from Article 61 to 65.

In fact, with regard to criminal penalties in addition to the piracy-related material element necessary for this offense. Intent on the part of the perpetrator must also be malicious, and the courts have the exclusive authority to determine this. A general or special *dol* is required by the legislature. Article

¹ According to a Paris court judgment of 12 January 2017: The content of a website is likely to benefit from copyright protection if its creator demonstrates that the form and presentation and/or the content of its site are based on a personal contribution that reflects its personality. Moreover, the fact that the site contains elements, the originality of which was not previously retained, does not prevent society from claiming copyright protection, since it justifies why the choice to combine all these elements constitutes an original approach. Failing to prove the original character of the claimed elements and the content of the website the company will be declared inadmissible in its claim for copyright infringement.



64 of Law 2-00 “Punishable by a term of imprisonment of two to six months, and a fine of 10,000 to 100,000 dirhams or any of them only, any person who has committed an unlawful act and by any means, for the purpose of commercial exploitation, a wilful violation: the copyright referred to in articles 9 and 10 or the rights of performers in article 50 or the rights of phonogram producers referred to in section 51 or the rights of broadcasting organizations referred to in article 52”. However, in the case of usual infringements, the penalties shall be doubled. The competent court for these offences may also order safety measures and ancillary penalties.

Regarding civil penalties, committing piracy offers the victim the chance to participate in the court as a civil party in addition to taking public action to recover damages. The amount of the damages must be determined in relation to the actual damage to the right holder's property and the amount of profits made by the infringer as a result of the violation. The legal authorities may limit the damages and interest in connection to the author's gains on the program that was hacked in the event that he was unaware of or lacked a good justification for engaging in such an activity. The judicial authorities may order that copies of such pirated software be destroyed or removed from commercial channels in order to protect the legitimate owner of that privilege. The lawful owner of a pirated copy, however, cannot have his property taken away because it is not the original (Ennashi, 2020).

It is true that Moroccan positive law provides a substantial legal arsenal to fight cybercrime connected to intellectual property and industrial property. However, due to the peculiarities of computer systems, the effectiveness of this arsenal is still suspended. Furthermore, when it comes to copyright infringement, counterfeiting, and the phenomena of software and application piracy, Morocco holds a dominant position on a global level. Several cases are available in the Moroccan case law on software piracy, on the design of viruses, the example of the Zotob virus case².

III. Blockchain issues in intellectual property law.

III.1. The techniques for using blockchain technology in intellectual property law.

We can explain concretely and briefly the blockchain used in intellectual property by the following steps.

First, a digital document in the form of a drawing or model is transformed into a digital footprint called the hash; it is an alphanumeric suite.

Then, a person (author of the digital document, third party company, etc.) enters the fingerprint number in a transaction on the blockchain: we are talking about the anchoring of the fingerprint. To register a transaction, the user needs a public key³ and a private key⁴ (associated with the public, personal and secret key), which is used to authenticate the transaction. What is recorded on the blockchain is not a data or an original document but a «hashed» digital footprint that describes the creation. This footprint has a portion of the previous block's digital footprint. This is why we call it a «blockchain» because all the «hashed» transactions are in blocks that are linked to each other.

Keep in mind the key features of this digital footprint. On the one hand, it is unique in that there cannot be two documents with the same cryptographic fingerprint (if you change a comma the

² A 19-year-old Moroccan, Farid Essebbar, considered the designer of the “Zotob” virus that attacked the Windows's 2000 operating system, was sentenced to two years in prison by the Moroccan justice. The Zotob virus reportedly exploited security breaches in the Windows 95, 98, ME, NT, 2000 and XP platforms. Victims of the Zotob virus included CNN, ABC News, New York Times, Disney, and San Francisco Airport.

³ This is open blockchain. Any player can become a node in the network, that is, enter new blocks, perform transactions on the blockchain and access transaction history.

⁴ Also called permission blockchain. This is a blockchain whose network nodes are controlled by a consortium with defined rules to verify and allow the appearance of new nodes. This consortium also controls access to the transaction history, the possibility of registering new blocks and the authorization to carry out transactions on the blockchain. The rules for joining the consortium can be more or less open and more or less complex.



fingerprint will be different). On the other hand, hashing works only in one direction: we move from the digital document to the hash, which is an impossible function to reverse. Concretely, this means that even if everyone can have access to a public blockchain, it is almost impossible to reconstitute the document that has been hashed and put on the blockchain, which guarantees the secrecy of the information written on the blockchain.

Finally, the transaction is then shared between the nodes of the network⁵ to be validated by minors⁶. Miners must use algorithms to solve mathematical problems on computers in order to validate. Proof of creation is the name given to this resolution creation. The first person to complete the mathematical puzzle correctly receives payment in cryptocurrency and provides proof to others. The transaction needs to receive 51% of the vote from minors to be recorded in the blockchain (Legrand, 2019).

These key characteristics of the blockchain can be summed up. It is decentralized, meaning that no centralized authority is required to validate and store information. Information is copied and has numerous synchronized copies to ensure its resilience. The blockchain is authenticated and irreversible—any registration is without the potential of change or deletion—because each piece of information is specific to a single user who has the option of maintaining their anonymity.

The blockchain has three main functions. It ensures the transfer of assets, constitutes a digital register and facilitates the automatic execution of contracts (smart contract). Only the last two aspects mainly concern intellectual property.

To date, we have seen several cases of developing use of intellectual property. In fact, there are systems for dating copyrighted creations, systems for managing rights holders' compensation with smart contracts.

Also, registers of intellectual property titles, private registers internal to companies (lab book or digital creations). In addition, there are projects to improve the fight against counterfeiting by using blockchain to improve the evidence and traceability of products.

III.2. The admission of Blockchain as a means of proof in intellectual property law.

Evidence is at the centre of civil infringement proceedings, in fact those who initiate infringement proceedings must successively demonstrate the existence of intellectual property rights (Magnier, 2019), the ownership of those rights and that those rights have been infringed and to determine how the blockchain evidence could be received by the judge and to what extent it would be likely to compete, a distinction should be made according to the rights in question.

Industrial property rights such as designs, trade names, and invention patents are given via an administrative process and grant their owner a monopoly of exploitation. In order to prove the existence of the rights to which he is relying, the applicant must produce a title and, if so, justify that it is still in valid. Actually, nothing prevents the owner of this industrial property right from digitizing it and subsequently securing it on a blockchain. However, only the title is legitimate in front of the judge, and it can only be obtained when the procedures outlined in the texts have been followed with the office designated to issue it. Therefore, using blockchain is currently of little to no interest.

⁵ Network nodes are computers in the blockchain network.

⁶ A minor is an individual verifying transaction performed by users on the network. The miner receives in real time all transactions issued by users on the network. It checks whether the electronic signature affixed by the issuer of the transaction is valid if the sender's address is in possession of the funds it claims to want to transfer to another address. Then it gathers all the transactions validated in a block and registered on the blockchain.



The issue with copyright is different. In fact, a content of the spirit's creator is granted an exclusive and enforceable intangible property right over the content by virtue of its creation, in accordance with Law 2-00 on copyright and similar rights. Therefore, no formality must be completed in order to receive protection under copyright. A person claiming possession of a creation in the absence of a title is required to show evidence of both the work's creation date and content.

However, the blockchain allows proving that on the date when the miners validated the transaction, a document was anchored there. The blockchain will play a role in the timestamp of creation. In reality, the infringement lawsuit's plaintiff may present a digital certificate in court that certifies the day the creation's imprint was anchored. Additionally, the blockchain inscription establishes the creation's content by combining the document, its description, and its imprint. For example, the author can produce in court the original of his creation and the hash inscribed on the blockchain and compare it with the hashed footprint on the blockchain.

Since the evidence is free, the judge has no reason to reject such a certificate; on the contrary, he must examine it. But, in the positive law, this ground of evidence has no more probative force than the other evidence submitted to it; contrary evidence may therefore be produced by the opposing party and will likewise be taken into consideration by the judge. Above all, the question arises as to under what conditions the correspondence between the claimed creation and the digital footprint recorded on the blockchain will be established; this operation requires the translation of an intelligible language into an encrypted language. It's possible that the courts will demand that the applicant use an expert or judicial officer to complete this translation or note the relevant circumstances in order to guarantee its absolute reliability (Legrand, 2019).

It must also be stressed that it is not enough to establish the date and content of a creation to benefit from copyright protection; it must also be original. However the blockchain obviously does not allow reporting the proof of the originality of the creation.

The infringement lawsuit's plaintiff must also demonstrate ownership. Applying the current legal and regulatory regulations, entries on the industrial property title, and any entries in the registers of the acts influencing the ownership or enjoyment of the deposit in question would yield proof of ownership for registered patents, trade, marks and designs. So those are the factors, and the judge will only consider those. Again, nothing stands in the way of an act of transfer, for instance, being anchored in the blockchain, but its capacity to be enforced against third parties is dependent upon being included in the register.

In terms of copyright, and despite the lack of title, the use of blockchain does not seem to be likely to facilitate proof. The document describing the allegedly counterfeit content is anchored by keys, one public and the other private; the identity of the person who carries out this anchoring- who, moreover, is not necessarily the author of the content- is therefore not mentioned. The author's name may be indicated in the initial document, but only his cryptographic footprint is anchored on the blockchain. However, as stated above, this imprint cannot constitute a disclosure of the work; the mention of the author's name is therefore purely declarative and no legal effect can be attached to it (Canas, 2019).

The contribution of the blockchain at the stage of proof of the ownership of rights, thus seems to be extremely reduced. But it could prove useful in two specific hypotheses: on the one hand, in the presence of a plural creation and, more particularly, a collaborative creation or a collective creation, the blockchain makes it possible to protect all the stages of creation over time, which will allow in case of dispute, to determine more easily the contribution of each one. The defendant, on the other hand, might utilize blockchain to defend his own rights and attempt to disprove the presumption of tenure, which is a simple presumption that is vulnerable to evidence to the contrary.



Additionally, the blockchain makes it possible to guarantee a product's traceability and, as a result, to confirm its legitimacy. It could therefore be an extremely useful tool for demonstrating that a product placed on the market by a third party is counterfeit, regardless of the intellectual property right in question.

Since counterfeiting may be established by any method, this proof seems entirely acceptable, in order to defend the violation of its intellectual property rights, and subject to the previously indicated technical limitations. By securing each of the stages of the product's life—design, manufacture, transport, distribution, and marketing—onto the blockchain, the plaintiff in the infringement action will be able to demonstrate to the jury that he will be spared.

Nevertheless, for a number of reasons, this is not a perfect proof. First, it is not enough to produce evidence that the alleged counterfeit product cannot be linked to the blockchain constituted by the rights holder to ensure that the counterfeit is, on a go-forward basis, created. The judge will likely rely on other evidence to hold that a mark, model or creation was unlawfully reproduced or limited. Above all, it will examine the other elements necessary for the characterization of counterfeiting. Secondly, the blockchain evidence does not have a higher evidentiary force than the other evidence and the judge will therefore be sovereign in assessing its value and scope.

Finally, the blockchain needs to support the management of evidence according to the idea of loyalty. We might therefore query the circumstances under which data stored on the blockchain will need to be gathered and examined in order to be accepted as evidence.

IV. References

AZDDOU N., (2018). « Le droit marocain des marques », in *Revue Marocaine Droit, Economie et Gestion*, N° 57.

AZZI T., (2011). « Les créations multimédias (bases de données, jeux vidéos...) » in *L'articulation des droits de propriété intellectuelle*, Ouvrage collectif sous la direction de Jean-Michel BRUGIERE, Dalloz, Paris.

BOIZARD M., (2018). « La valorisation des données numériques par la protection juridique des algorithmes », in *IP/IT*, N°2, Dalloz.

CANAS S., (2019). « Blockchain et preuve le point de vue du magistrat », in *IP/IT*, N° 2, Dalloz

ENNASHI Khaled, (2020). *La criminalité numérique en droit marocain*, Librairie Rachad, Settat.

FAUCHOUX Vincent, DEPREZ Pierre et BRUGIERE Jean-Michel, (2013). *Le droit de l'internet : Lois, contrats et usages*, LexisNexis, 2ème éd, Paris.

GELLES V. et POIDEVIN B., (2015). « Réflexions autour de la création numérique dans l'entreprise : problématiques juridiques, enjeux et pistes de réforme » in *La propriété intellectuelle et la transformation numérique de l'économie*, Ouvrage collectif sous la direction de Fatima GHILASSENE et Laurence JOLY, INPI, 1ère éd., France.

LEGRAND S., (2019). « Enjeux de la blockchain du point de vue du praticien », in *IP/IT*, N° 2, Dalloz.

MACREZ Frank, (2011). « Logiciel : le cumulard de la propriété intellectuelle » in *L'articulation des droits de propriété intellectuelle*, Ouvrage collectif sous la direction de Jean-Michel BRUGIERE, Dalloz, Paris.



INTERNATIONAL ASIAN CONGRESS ON CONTEMPORARY SCIENCES – VII

MAGNIER V., (2019). « La Blockchain, un choix de gouvernance pertinent ? » in Blockchain et droit des sociétés, Ouvrage collectif sous la direction de Véronique MAGNIER et Patrick BARBAN, Dalloz, Paris.

MATTATIA Fabrice, (2021). Droit d'auteur et propriété intellectuelle dans le numérique, Eyrolles, 3ème éd., Paris.

PIGNATARI O. et COUSIN A., (2016). « L'originalité des logiciels », in IP/IT, N° 5, Dalloz.

SCHMIDT-SZALEWSKI Joanna et PIERRE Jean-Luc, (2007). Droit de la propriété industrielle, Litec, 4ème éd., coll. Manuels, Paris.

SNE, (1994). Questions juridiques relatives aux œuvres multimédia, Livre blanc du Groupe de travail audiovisuel et multimédia.

VIVANT Michel et BRUGIERE Jean-Michel, (2012). Droit d'auteur et droits voisins, Dalloz, 2^{ème} éd., Paris.



FINDIK KABUĞU, BADEM KABUĞU VE KARIŞIMLARININ TORREFAKSİYONU

Elif KARDAŞ

Fırat Üniversitesi, Mühendislik Fakültesi, Kimya Mühendisliği Bölümü, YÖK 100/2000 Doktora Bursiyeri ORCID: 0000-0003-4726-0072

Melek YILGIN

Doç. Dr, Fırat Üniversitesi, Mühendislik Fakültesi, Kimya Mühendisliği Bölümü
ORCID: 0000-0002-4177-8025

Neslihan DURANAY

Doç. Dr, Fırat Üniversitesi, Mühendislik Fakültesi, Kimya Mühendisliği Bölümü
ORCID: 0000-0001-7259-1864

Özet

Bu çalışmada, badem kabuğu ve fındık kabuğunun sabit yatak torrefaksiyon sisteminde inert ortamda 290°C’de farklı işlem süreleri (10, 20, 40 ve 60 dakika), iki farklı tane boyutu (-4+8 mesh ve -8+16 mesh) ve bu iki biyokütlenin karışım oranlarının (%25, %50 ve %75FK) katı ürün verimi üzerine etkisi incelendi.

İşlem süresinin katı ürün verimi üzerinde belirli bir süreye kadar etkili olduğu fındık kabuğunda daha küçük tane boyutunda işlem süresinin daha etkili olduğu sonucuna varıldı. Tane boyutunun katı ürün veriminin azalmasında etkili olduğu görüldü. Biyokütlenin karışım halinde torrefaksiyon işlemine tabi tutulmasının karışımı oluşturan biyokütlelerden farklı davrandığı ve işlem sırasında biri birini etkilediği katı ürün veriminde artışa neden olduğu tespit edildi. Karışımların katı ürünlerinin kısa analiz sonuçları tek başına torrefaksiyon işleminden elde edilen katı ürünler ile karşılaştırıldığında uçucu madde miktarlarının yüksek olduğu ve sabit karbon içeriklerinin düşük olduğu belirlendi.

Anahtar kelimeler: Biyokütle, torrefaksiyon, sabit yatak

TORREFACTION OF HAZELNUT SHELLS, ALMOND SHELLS AND BLENDS

Abstract

In this study, different processing times (10, 20, 40 and 60 minutes), two different particle sizes (-4+8 mesh ve -8+16 mesh) and the blend ratios of these two biomass (25%, 50% and 75FK%) were determined in the fixed bed torrefaction system of almond shell and hazelnut shell at 290 °C in an inert environment on solid product yield was investigated.

It was concluded that the processing time was effective on the solid product yield up to a certain time, and the processing time was more effective in smaller particle size in hazelnut shells. It was observed that the particle size was effective in decreasing the solid product yield. It was determined that the torrefaction process of the biomass as a blend behaves differently from the biomass forming the blend and affects each other during the process, resulting in an increase in solid product yield. When Proximate analysis results of the solid products of the blends were compared with the solid products obtained from the torrefaction process alone, it was determined that the amount of volatile matter was high and the fixed carbon content was low.

Keywords: Biomass, torrefaction, fixed bed



GİRİŞ

Atmosferdeki CO₂ konsantrasyonu, küresel ısınmaya ve geri döndürülemez iklim değişikliğine neden olan fosil yakıtların kullanılmasından kaynaklanan büyük miktarlardaki sera gazı emisyonları nedeniyle hızla artmaktadır (Ameyaw vd., 2019). Öte yandan, hızlı ekonomi ve endüstriyel büyüme nedeniyle dünya enerji talebi küresel ölçekte katlanarak artmaktadır. Küresel enerji tüketiminin 2040 yılına kadar mevcut senaryoya göre %20-30 oranında artması bekleniyor (Newell vd., 2019). Fosil yakıtların tükenmesi ve sera gazı emisyonları konusundaki artan endişeler, atık organik biyokütleden üretilen biyoyakıtlar gibi alternatif enerji kaynaklarının aranmasına yol açmıştır (Vakulchuk vd., 2020).

Fosil yakıtlar ile ilgili bu sorunları ortadan kaldırmak için yenilenebilir enerjinin gelişimi büyük ilgi görmüştür. Mevcut çeşitli enerji kaynakları olmasına rağmen, biyokütle şu anda dünyadaki dördüncü en büyük birincil enerji kaynağıdır (Chen vd., 2012). Doğa, çok çeşitli biyokütle kaynakları sağlamakta ve küresel biyokütle üretiminin yıllık yaklaşık 100 milyar ton olduğu tahmin edilmektedir (Sheldon, 2014). Biyokütle sadece gıda üretimi için kullanılamaz, aynı zamanda yenilenebilir yakıtlar, karbon tutucular ve gübrelerin üretimi için de potansiyel bir aday olarak kabul edilir (Nunes vd., 2020; Ubando vd., 2020). Biyokütle, ısı, elektrik, yakıt, kimyasallar ve diğer biyo-ürünler üretme potansiyeline sahip yenilenebilir bir kaynaktır (Zhou vd., 2011).

Biyokütle, selüloz, hemiselüloz ve lignin içeren lignoselülozik veya beslenme amacıyla kullanılan lignoselülozik olmayan olarak sınıflandırılabilir (Kota vd., 2022). Lignoselülozik biyokütle yapısal olarak heterojendir, bu nedenle fiziksel özellikleri tek tip değildir. Aynı zamanda düşük enerji ve kütle yoğunluğuna sahiptir ve doğası gereği higroskopiktir, bu nedenle taşıma, nakliye, depolama ve dönüştürme için uygun değildir (Phanphanich ve Mani, 2011; Uemura vd., 2011; Kota vd., 2022).

Lignoselülozik biyokütle, biyodönüşüm prosesleri yoluyla biyodizel, biyoetanol ve biyogaz üretimi için kullanılabilir. Bununla birlikte, lignoselülozik biyokütleyi biyomateryal üretmek için doğrudan fermente etmek zordur ve bu nedenle bir ön işleme gereklidir (Ong vd., 2020).

Günümüzde, torrefaksiyon, piroliz, gazlaştırma, yakma ve sıvılaştırma dahil olmak üzere termokimyasal dönüştürme işlemleri birçok araştırmacı ve endüstride büyük ilgi görmüştür (Chen vd., 2019). Yanma işlemi dışında katı, sıvı ve gaz biyoyakıtların üretildiği bu termokimyasal yöntemlerin çalışma koşulları oksijen kaynağına ve reaksiyon sıcaklığına bağlıdır (Xia vd., 2021).

Torrefaksiyon, oksidatif olmayan (inert) veya oksidatif atmosferlerde 200 ve 300°C arasında gerçekleştirilen termokimyasal bir işlemdir; süreç hafif piroliz olarak sınıflandırılır (Xu vd., 2021). Torrefaksiyon biyokütle, geliştirilmiş öğütülebilirlik, daha düşük nem alma kapasitesi, O/C ve H/C oranları, daha yüksek ısı değeri ve daha iyi tutuşma/yanma özelliklerine sahiptir. Bu özellikler biyokütlenin yakıt olarak kullanılmasını kolaylaştırır (Barskov vd., 2019). Biyokütlenin torrefaksiyon ürün özellikleri, kalış süresi, başlangıçtaki nem içeriği, ısıtma hızı, partikül boyutu, biyokütle türü ve reaktör tipi gibi çeşitli parametrelerden etkilenir (Abdulyekeen vd., 2021).

Biyokütlenin tek başına ve karışım halinde torrefaksiyonu (Duranay ve Akkuş, 2021; Yılmaz vd., 2019; Abdullah vd., 2022) ile ilgili çalışmaların yanı sıra çalışmada kullanılan fındık kabuğu ve badem kabuğunun torrefaksiyonu ile ilgili çalışmalar da bulunmaktadır (Bilgic vd., 2017; Chiou vd., 2016; Aydemir ve Yılmaz, 2022). Bu çalışmada, badem kabuğu ile lignin içeriği yüksek fındık kabuğunun torrefaksiyonu 290°C'de sabit yatak reaktöründe gerçekleştirildi. Torrefaksiyon ürün verimleri (katı (biyokömür), sıvı ve gaz ürünler) üzerine işlem süresi ve tane boyutunun etkisi ile bunların belirli oranlarda karışımlarının etkisi incelendi.

MATERYAL VE METOD

Çalışmada biyokütle olarak fındık ve badem kabukları kullanıldı. Fındık ve badem kabuklu şekilde ticari olarak temin edildi. Kabuklu fındık ve bademe kırma işlemi uygulandı ve elde edilen kabuklar



laboratuvar ortamında bir hafta süreyle kurumaya bırakıldı. Kabuklar daha sonra öğütüldü ve elenerek -4+8 mesh ve -8+16 mesh tane boyutları torrefaksiyon deneylerinde -100 mesh tane boyutu ise kısa analiz için kullanılmak üzere plastik poşetlerde deneylerde kullanılmaya kadar muhafaza edildi. Torrefaksiyon deneyleri Şekil 1a'da fotoğrafı verilen deney sisteminde yürütüldü. Torrefaksiyon işleminde 150 mm uzunluğunda 35 mm çaplı pyrex cam reaktör kullanıldı. Reaktör, dikey kesitli içerisinde refrakter tuğlalar bulunan 105 mm uzunluğunda ortasında reaktörün yerleştirilmesi için delik bulunan silindirik fırın içerisine yerleştirilmiştir. Fırın değişik voltaj transformatörü ile ısıtıldı. Çalışma sıcaklığı cam reaktör ile temas eden termocift ile kontrol edildi.

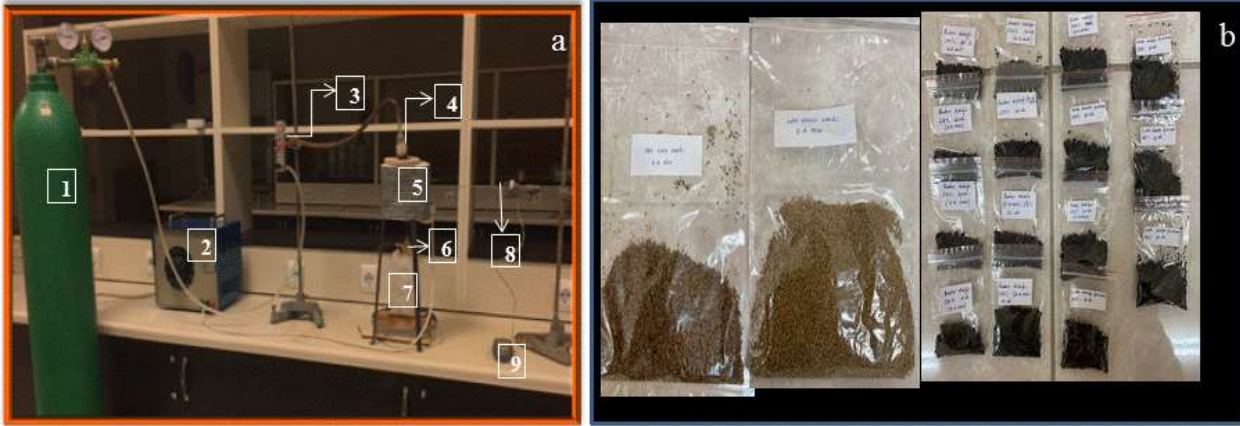

Şekil 1. a) Torrefaksiyon deney sistemi: 1. Azot tüpü, 2. Değişik voltaj transformatörü, 3. Rotametre, 4. Cam reaktör, 5. Silindirik fırın, 6. Sıvı ürün toplama kabı, 7. Buz banyosu, 8. Termocift, 9. Termocift okuyucu

b)Fındık ve badem kabukları ile 10 dk. işlem süresinde elde edilen biyokömür örnekleri

Torrefaksiyon işleminde cam reaktöre yaklaşık 10 g -4+8 mesh veya -8+16 mesh tane boyutlu kabuklardan konularak fırın içerisine yerleştirildi ve sonra sistem ısıtılmadan önce içerisinden 5 dk 100 ml/dk akış hızında azot gazı geçirildi. Sistem daha sonra torrefaksiyon deneylerinin yapılacağı 290°C'de ulaşması için ısıtıldı ve bu sıcaklığa yaklaşık 12 dakikada ulaşması sağlandı. İşlem sırasında oluşan yoğunlaşabilen (sıvı) kısım sürükleyici gaz yardımıyla buz banyosuna yerleştirilen ağırlığı bilinen sıvı ürün toplama kabında toplanırken yoğunlaşmayan gaz ürün sıvı toplama kabının çıkış ucundan dışarı çıktı. Torrefaksiyon işlemi belirli sürede yürütüldükten sonra ısıtma işlemine son verildi ve sistem azot atmosferinde soğumaya bırakıldı. Reaktör içerisindeki torrefiye ürün (biyokömür) ve sıvı toplama kabı içerisindeki sıvı ürün miktarları belirlendi. Katı ve sıvı ürün verimleri deneysel olarak hesaplandı. Gaz ürün verimi ise farktan belirlendi. Deney öncesi ve sonrası FK, BK ve torrefiye FK ve BK (katı ürünler) Şekil 1b'de görülmektedir.

Torrefaksiyon deneyleri katı, sıvı ve gaz ürün verimleri üzerine işlem süresinin etkisini incelemek için 10, 20, 40 ve 60 dakika, tane boyutunun etkisini incelemek için -4+8 mesh ve -8+16 mesh tane boyutunda yürütüldü. Karışım oranının katı ürün verimine etkisi 290°C'de 40 dakika işlem süresinde %25, %50 ve %75 FK içeren FK-BK karışımları kullanılarak yapıldı.

İşlem görmemiş FK, BK ve bunların torrefaksiyonundan elde edilen katı ürünlerin uçucu madde ve kül içerikleri ASTM standardına göre belirlendi. FK ve BK'nın nem içerikleri Mettler LJ16 nem tayin cihazında belirlendi.



SONUÇLAR VE TARTIŞMA

Torrefaksiyon ürün verimleri

Badem kabuğunun (BK) 290°C’de işlem süresi ve tane boyutuna bağlı olarak elde edilen katı, sıvı ve gaz ürün verimleri Şekil 2’de görülmektedir. Badem kabuğunun her iki tane boyutunda da işlem süresi ile katı ürün verimleri 40 dakikalık işlem süresinde artmıştır. Bu artış -8+16 mesh tane boyutunda daha belirgindir. Bu durum işlem sırasında oluşan ağır sıvı ürünlerin torrefiye biyokütlenin gözeneklerine haps olmasından kaynaklanabilir. Tane boyutunun torrefaksiyon üzerinde etkili olduğu torrefaksiyon işlemi sırasında elde edilen katı sıvı ve gaz ürün verimlerindeki değişimlerde açıkça görülmektedir. Örneğin her iki tane boyutu ile yürütülen deneylerde gaz ürün verimi -4+8 mesh tane boyutunda %1,6 değerine sahip olmasına rağmen -8+16 mesh tane boyutunda bu değer yaklaşık %14’tür. Bu durum torrefaksiyon sırasında, daha küçük partikül boyutlu biyokütlenin daha yüksek bir temas yüzey alanı ve dolayısıyla daha yüksek ısı transfer etkisinden kaynaklanmaktadır (Nhuchhen vd., 2014). Literatürde tane boyutunun kütle kaybı üzerinde etkili olmadığı (Sabil vd., 2013) veya etkili olduğunu (Medic vd., 2012) vurgulayan çalışmalar bulunmaktadır. İşlem süresinin katı ürün verimi üzerine etkisi -8+16 mesh tane boyutunda daha belirgindir.

Sıvı ürün ve gaz ürün verimlerinin tane boyutu ve işlem süresi ile düzenli bir değişim sergilemediği Şekil 2’de görülmektedir. Şekilde katı ürün verimindeki azalma sıvı ve gaz ürün verimlerinde artışa neden olmaktadır. Gaz ürün torrefaksiyon işlemi sırasında yoğunlaşmayan ve genellikle H₂, CO, CH₄ ve CO₂ içerirken sıvı ürün su, asetik asit, alkoller, aldehitler, ketonlar, furfural ve diğer mono aromatik bileşikler içermektedir (Chen vd., 2017).

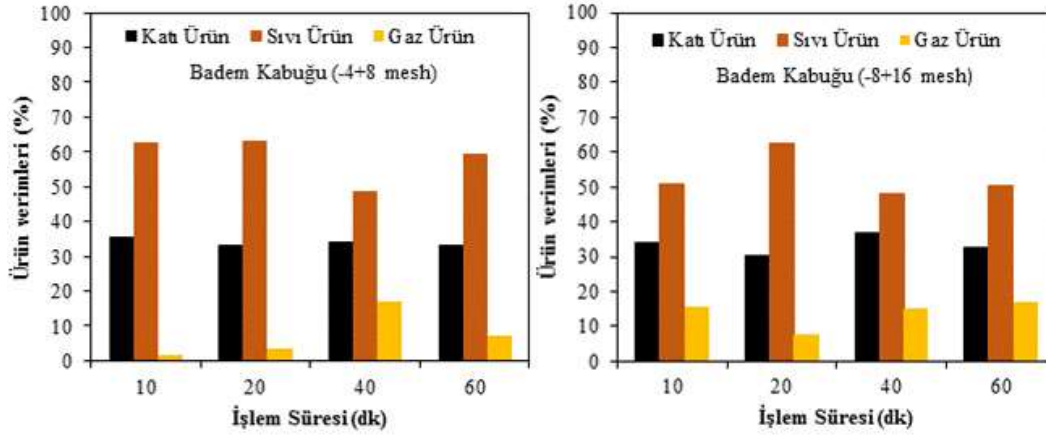

Şekil 2. Badem kabuğunun farklı tane boyutunun 290°C’de işlem süresi ile ürün verimlerinin değişimi

Fındık kabuğunun torrefaksiyonundan elde edilen ürün verimleri üzerine tane boyutunun ve işlem süresinin etkisi Şekil 3’de görülmektedir. Katı ürün verimi -4+8 mesh tane boyutunda 40 dakikalık işlem süresinde azalmasına rağmen -8+16 mesh tane boyutunda 20 ve 40 dakikalık işlem sürelerinde azalmış ve işlem süresinin uzamasıyla katı ürün verimi artmıştır. Bu durumda işlem sırasında sıvı ve gaz ürünün sıvı ürün toplama kabına geçişi sırasında biyokütle taneleri arasında geçiş süresinin uzun olması nedeni ile biyokütle gözeneklerine haps olmasından ve katı ürün verimindeki artış ile sonuçlanmasından kaynaklanabilir. Katı ürün veriminin 20 ve dakikalık işlem sürelerinde azalması tane boyutunun azalması ile fındık kabuğunda bulunan selüloz ve lignininde önemli miktarda parçalandığını gösterebilir. Bu biyokütlede gaz ürün veriminin her iki tane boyutunda ilk 10 dakikalık işlem süresinde yaklaşık %15 verime sahip olması dikkat çekicidir. Bu durum BK ve FK karşılaştırıldığında biyokütle türünün ürün verimleri üzerinde etkili olduğunu göstermektedir.

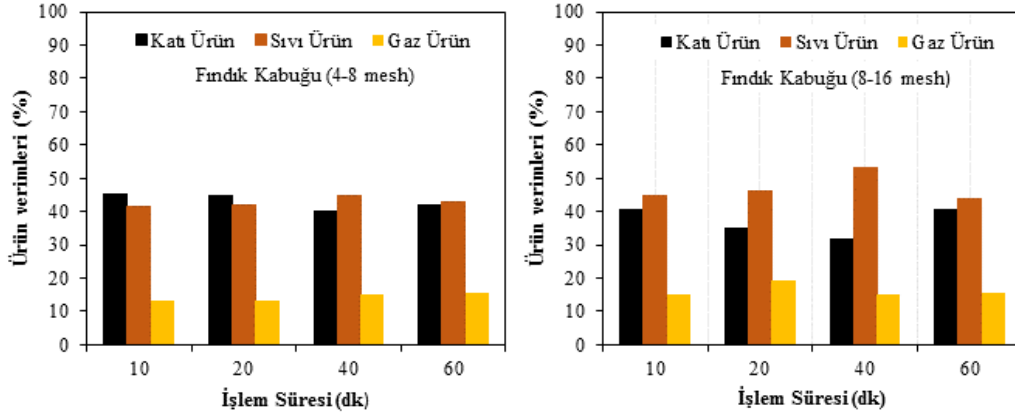

Şekil 3. Fındık kabuğunun farklı tane boyutunun 290°C’de işlem süresi ile ürün verimlerinin değişimi

Biyokütle türünün ürün verimleri üzerine etkisi Şekil 4’de fındık kabuğu ve badem kabuğunun -8+16 mesh tane boyutunun işlem süresi ile katı ürün verimindeki değişiminde görülmektedir. FK’dan elde edilen katı ürün veriminin 40 dakikalık işlem süresi dışında BK’dan elde edilen katı ürün veriminden yüksek olarak belirlenmiştir. Bu durum bu iki biyokütlerde bulunan başlıca hemiselüloz, selüloz ve lignin içeriklerinden kaynaklanmaktadır. Literatürde fındık kabuğunun holoselüloz (selüloz+hemiselüloz) içeriğinin 56,6 ve lignin içeriğinin % 40 olduğu (Acma vd., 2017), badem kabuklarının hemiselüloz, selüloz ve lignin içeriklerinin sırasıyla %25-34, %24-33 ve %27-33 arasında değiştiği (Fukuda ve Hsieh, 2022) vurgulanmıştır. Biyokütlerdeki hemiselüloz, selüloz ve lignin için ayrışma sıcaklık aralıkları 200–450 °C, 275–500 °C ve 130–900 °C olarak belirtilmiş olup 200 °C’de öncelikle hemiselülozun ayrışmasıyla başladığı 250 °C’den sonra daha yüksek sıcaklıklarda, bir miktar lignin ve bir miktar selülozun bozunmasıyla daha belirgin şekilde değiştiği belirtilmiştir (Thengang vd., 2022). FK’nın lignin içeriğinin BK’dan yüksek olması nedeniyle her bir işlem süresinde de katı ürün verimleri daha yüksektir.

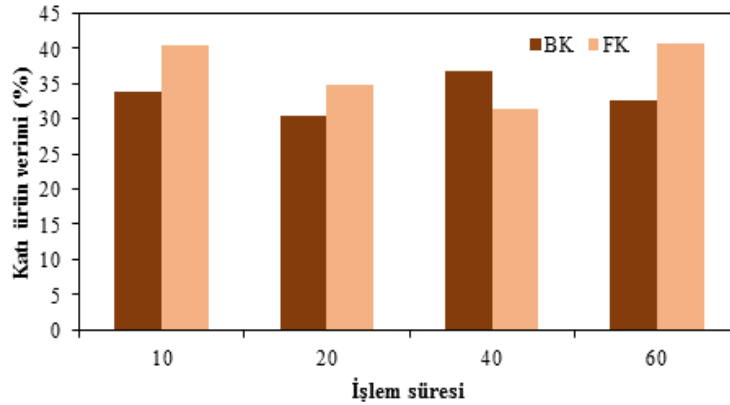

Şekil 4. Fındık kabuğu ve badem kabuğunun işlem süresine bağlı olarak katı ürün verimindeki değişimler

FK-BK karışımlarının 290°C’de 40 dakika işlem sürelerinde elde edilen katı ürün verimleri ile ham örneklerin bu işlem sürelerinde elde edilen katı ürün verimlerine göre hesaplanan ve beklenen değerleri gösteren sonuçlar Şekil 5’de görülmektedir. Şekilde deneysel olarak belirlenen katı ürün verimleri beklenen değerlerden yüksektir ve %50FK içeren karışımın katı ürün verimi diğer karışımlardan daha yüksek olarak belirlenmiştir. Bu durum lignin içeriği yüksek biyokütle ile hemiselüloz içeriği yüksek biyokütlenin birlikte torrefaksiyonu sırasında biri birini etkilediği ve katı



ürün verimini arttırdığı söylenebilir. Biyokütle karışımlarından daha yüksek katı ürün elde edildiği literatürde vurgulanmıştır (Abdullah vd., 2022).

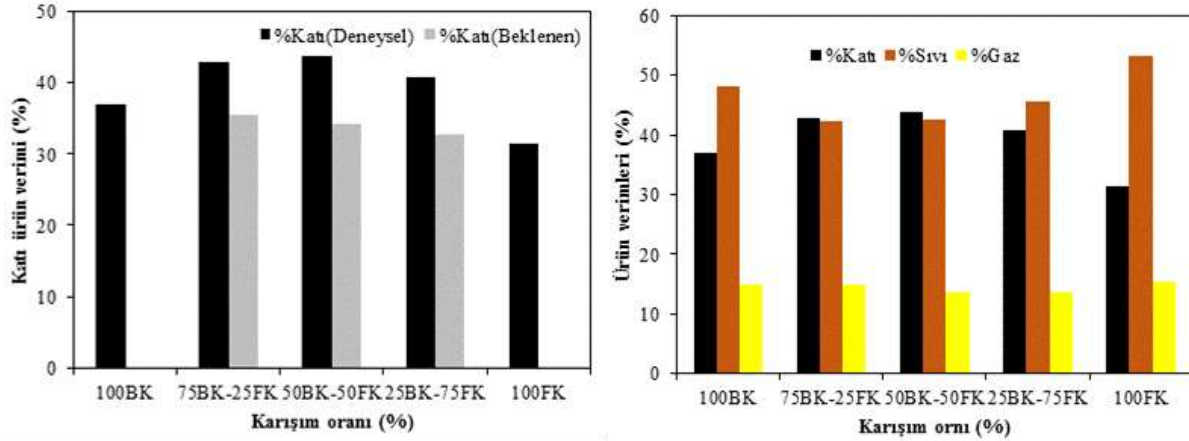

Şekil 4. BK-FK karışımlarının -8+16 mesh tane boyutunun 40 dakika işlem süresinde elde edilen ürün verimleri

Katı ürünün (biyokömür) kısa analizleri

Biyokütlenin kısa analiz içeriklerinin torrefaksiyon işlemi ile değişimi Tablo 1’de verilmiştir. Tabloda karşılaştırma amacı ile işlem görmemiş biyokütle örnekleri ile -8+16 mesh tane boyutu kullanılarak 40 dakika işlem süresi ile yürütülen deneylerden elde edilen katı ürünlerin kısa analiz sonuçları verilmiştir. Tabloda katı ürün verimleri 40 dakikalık işlem süresine göre badem kabuğu için TBK40 fındık kabuğu için TFK40 olarak adlandırıldı.

Tablo 1. Fındık kabuğu, badem kabuğu ve katı ürünlerin kısa analiz sonuçları (*:Farktan belirlendi.)

Örnekler	%Nem	%Uçucu madde	%Kül	%Sabit karbon*
BK	7,00	49	0,30	18,21
FK	8,03	75	1,24	24,98
TBK40	-	30	0,80	59,20
TFK40	-	34	1,92	72,74
%75FK-%25BK	-	33	1,60	57,57
%50FK-%50BK	-	51	1,03	55,46
%25FK-%75BK	-	50	0,75	56,75

İşlem görmemiş BK ve FK örnekleri ile karşılaştırıldığında torrefaksiyon işlemi ile elde edilen TBK40 ve TFK40 katı örneklerinde uçucu madde içeriğinin çok fazla azaldığı kül içeriklerinin ise arttığı görülmektedir. Uçucu madde miktarı karmaşık polimerik bileşenlerin kimyasal dönüşümleri ve bozunması nedeniyle azalır, bu da kömüre benzer özelliklere sahip kırılğan biyokömür ürünleri ile sonuçlanır (Abdullah vd., 2022). Katı ürünlerdeki kül miktarındaki artış ise torrefaksiyon işlemi sırasında C-H bağlarının parçalanması nedeniyle uçucu madde kaybına neden olması ve torrefaksiyon ürününde kül içeriğinin daha da belirginleşmesinden kaynaklanmaktadır (Sukiran vd., 2021).

Karışımların uçucu madde içeriklerinin TFK40 ve TBK40 örneklerine göre daha yüksek olduğu sabit karbon içeriklerinin ise daha düşük olduğu görülmektedir. Literatürde ise biyokütle karışımlarının



torrefaksiyonu sonucu karışımların uçucu madde miktarlarının %45'ten az olduğu sabit karbon miktarının %64'e yükseldiği belirtilmiştir. Ayrıca çalışmada biyokütlelerin karışım halinde kullanılmasının sabit karbon içeriğinde artışa ve uçucu madde miktarında azalmaya neden olduğu da vurgulanmıştır (Abdullah vd., 2022).

Sonuçlar

Badem kabuğu ve fındık kabuğunun sabit yatak torrefaksiyon sisteminde 290°C'de farklı işlem süreleri, tane boyutu ve bu iki biyokütlenin karışım oranlarının katı ürün verimi üzerine etkisinin incelendiği çalışmada aşağıdaki sonuçlara varılmıştır:

- ❖ İşlem süresinin ve tane boyutunun katı ürün verimi üzerinde etkili olduğu belirlendi.
- ❖ Biyokütlenin yapısında bulunan hemiselüloz, selüloz ve lignin miktarının katı ürün verimi üzerinde etkili olduğu lignin içeriği yüksek biyokütlenin daha yüksek katı ürün verimi ile sonuçlandığı görüldü.
- ❖ Biyokütlenin karışım halinde torrefaksiyonunda elde edilen katı ürün verimlerinin karışımı oluşturan biyokütlelerden daha yüksek olduğu belirlendi.
- ❖ Katı ürünün (biyokömür) uçucu madde ve sabit karbon içeriklerindeki değişimin biyokütlelerin tek başına veya karışım halinde torrefaksiyonu üzerinde etkili olduğu sonucuna varıldı.

Kaynaklar

Abdullah I, Ahmad N, Hussain M, Ahmed A, Ahmed U, Park Y K 2022. *Conversion of biomass blends (walnut shell and pearl millet) for the production of solid biofuel via torrefaction under different conditions*. Chemosphere, 295:133894.

Abdulyekeen KA, Umar AA, Patah MFA, Daud WMAW 2021. *Torrefaction of biomass: Production of enhanced solid biofuel from municipal solid waste and other types of biomass*. Renewable and Sustainable Energy Reviews, 150:111436.

Ameyaw B, Yao L, Oppong A, Agyeman, JK 2019. *Investigating, forecasting and proposing emission mitigation pathways for CO₂ emissions from fossil fuel combustion only: A case study of selected countries*. Energy policy, 130:7-21.

Aydemir B, Yılmaz M2022. *Fındık Kabuğunun Torrefaksiyon ve Yanma davranışının İncelenmesi*. Karadeniz Fen Bilimleri Dergisi, 12 (1):51-65.

Barskov S, Zappi M, Buchireddy P, Dufreche S, Guillory J, Gang D, Hernandez R, Bajpai R, Baudier J, Cooper R, Sharp R 2019. *Torrefaction of biomass: A review of production methods for biocoal from cultured and waste lignocellulosic feedstocks*. Renewable Energy, 142:624-642.

Bilgic E, Yaman S, Haykiri-Acma H, Kucukbayrak S 2016. *Is torrefaction of polysaccharides-rich biomass equivalent to carbonization of lignin-rich biomass? Bioresource technology*, 200:201-207.

Chen WH, Lu KM, Tsai CM 2012. *An experimental analysis on property and structure variations of agricultural wastes undergoing torrefaction*. Applied Energy, 100:318-325.

Chen D, Mei J, Li H, Li Y, Lu M, Ma T, Ma Z 2017. *Combined pretreatment with torrefaction and washing using torrefaction liquid products to yield upgraded biomass and pyrolysis products*. Bioresource technology, 228:62-68.

Chen WH, Lin YY, Liu HC, Chen T C, Hung CH, Chen CH, Ong HC 2019. *A comprehensive analysis of food waste derived liquefaction bio-oil properties for industrial application*. Applied Energy, 237:283-291.



Chiou BS, Valenzuela-Medina D, Bilbao-Sainz C, Klamczynski AP, Avena-Bustillos RJ, Milczarek RR, Du W-X, Glenn GM, Orts WJ 2016. *Torrefaction of almond shells*: Effects of torrefaction conditions on properties of solid and condensate products. *Industrial Crops and Products*, 86:40-48

Duranay ND, Akkuş G 2021. *Solid fuel production with torrefaction from vineyard pruning waste*. *Biomass Conversion and Biorefinery*, 11(6):2335-2346.

Fukuda J, Hsieh YL 2022. *Almond shell nanocellulose*: Characterization and self-assembling into fibers, films, and aerogels. *Industrial Crops and Products*, 186:115188.

Haykiri-Acma H, Yaman S, Kucukbayrak S 2017. *Effects of torrefaction on lignin-rich biomass (hazelnut shell)*: Structural variations. *Journal of Renewable and Sustainable Energy*, 9(6):063102

Kota KB, Shenbagaraj S, Sharma PK, Sharma AK, Ghodke PK, Chen WH 2022. *Biomass torrefaction*: An overview of process and technology assessment based on global readiness level. *Fuel*, 324:124663.

Medic D, Darr M, Shah A, Rahn S 2012. *The effects of particle size, different corn stover components, and gas residence time on torrefaction of corn stover*. *Energies*, 5(4):1199-1214.

Newell R, Raimi D, Aldana G 2019. *Global energy outlook 2019: the next generation of energy*. *Resources for the Future*, 1:8-19.

Nhuchhen DR, Basu P, Acharya B 2014. *A comprehensive review on biomass torrefaction*. *International Journal of Renewable Energy & Biofuels*, 2014:1-56.

Nunes LJR, Causer T.P, Ciolkosz D 2020. *Biomass for energy: A review on supply chain management models*. *Renewable and Sustainable Energy Reviews*, 120:109658.

Ong HC, Chen W H, Singh Y, Gan YY, Chen CY, Show PL 2020. *A state-of-the-art review on thermochemical conversion of biomass for biofuel production: A TG-FTIR approach*. *Energy Conversion and Management*, 209:112634.

Phanphanich M, Mani S 2011. *Impact of torrefaction on the grindability and fuel characteristics of forest biomass*. *Bioresource technology*, 102(2): 1246-1253.

Sabil KM, Aziz MA, Lal B, Uemura Y 2013. *Effects of torrefaction on the physiochemical properties of oil palm empty fruit bunches, mesocarp fiber and kernel shell*. *Biomass and Bioenergy*, 56:351-360.

Sheldon RA 2014. *Green and sustainable manufacture of chemicals from biomass: state of the art*. *Green Chemistry*, 16(3):950-963.

Sukiran MA, Daud WMAW, Abnisa F, Nasrin AB, Aziz A A, Loh SK 2021. *A comprehensive study on torrefaction of empty fruit bunches: characterization of solid, liquid and gas products*. *Energy*, 230:120877.

Thengane SK, Kung KS, Gomez-Barea A, Ghoniem AF 2022. *Advances in biomass torrefaction: Parameters, models, reactors, applications, deployment, and market*. *Progress in Energy and Combustion Science*, 93:101040.

Ubando AT, Felix CB, Chen WH 2020. *Biorefineries in circular bioeconomy: A comprehensive review*. *Bioresource technology*, 299:122585.

Uemura Y, Omar WN, Tsutsui T, Yusup S B 2011. *Torrefaction of oil palm wastes*. *Fuel*, 90(8):2585-2591.

Vakulchuk R, Overland I, Scholten D 2020. *Renewable energy and geopolitics: A review*. *Renewable and Sustainable Energy Reviews*, 122:109547.

Xia C, Cai L, Zhang H, Zuo L, Shi SQ, Lam SS 2021. *A review on the modeling and validation of biomass pyrolysis with a focus on product yield and composition*. *Biofuel Research Journal* 29: 1296-1315.

Xu, J., Huang, M., Hu, Z., Zhang, W., Li, Y., Yang, Y., Zhou, Y., Zhou, S., Ma, Z. (2021). Prediction and modeling of the basic properties of biomass after torrefaction pretreatment. *Journal of Analytical and Applied Pyrolysis*, 159, 105287.



INTERNATIONAL ASIAN CONGRESS ON CONTEMPORARY SCIENCES – VII

Yilgin M, Duranay N, Pehlivan D 2019. *Torrefaction and combustion* behaviour of beech wood pellets. *Journal of Thermal Analysis and Calorimetry*, 138(1):819-826.

Zhou C H, Xia X, Lin CX, Tong DS, Beltramini J 2011. *Catalytic conversion* of lignocellulosic biomass to fine chemicals and fuels. *Chemical Society Reviews*, 40(11):5588-5617.



PLAZMA VE BİLEŞİMİ, TROMBOSİTLERİ, YAPISI, MİKTARI VE İŞLEVİ

Kərimova Rəna Cabbar kızı

Dr., Azərbaycan Tıp Universitesi, Deneysel Cerrahi Anabilim Dalı Uzman Araştırmacı, Tıpta Felsefe Doktoru

Tulumbacı Cəfərova Nərminə İlham kızı

Dr., Bakü Tıp Fakültesi No. 1, Normal insan anatomisi ve fiziolojisi ve Patolojinin temelleri öğretmeni

Ağayeva Asiya Hacı kızı

Azərbaycan Tıp Universitesi, Normal Fizioloji Anabilim Dalı, Yrd., Biyolojide Felsefe Doktoru, Doçent

Bayramov Adil Allahyar oğlu

Azərbaycan Tıp Universitesi, Normal Fizioloji Anabilim Dalı, Yrd.

Həsənova Xumar Əliövsət kızı

Azərbaycan Tıp Universitesi, Deneysel Cerrahi Anabilim Dalı, Kıdemli Araştırmacı, Tıpta Felsefe Doktoru

Özet

Kan, lenf ve hücreler arası sıvı vücudun iç ortamı olarak adlandırılır. Daha spesifik olarak, kan, vücudun hücresiz iç sıvı ortamını veya kan plazması ve vasküler sistemde dolaşan bağımlı hücrelerden oluşan vücudun iç ortamını ifade eder. Pıhtılaşmış kan, trombüs ve bazı plazma proteinlerinden oluşur. Serum, fibrinojenin uzaklaştırıldığı plazmanın berrak sıvı kısmıdır. Kan, vücudun bütünleştirici sistemlerinden biridir. Vücudun bireysel organlarının durumundaki çeşitli dalgalanmalar, kan sisteminde değişikliklere neden olur ve bunun tersi de geçerlidir. Trombositler kanın pıhtılaşmasından sorumlu kan hücreleridir. Damar duvarı hasar görürse, trombositler hasar bölgesine gider ve kanamayı durdurmak için bir tıkaç veya pıhtı oluşturur. Düşük trombosit sayısı, kontrolsüz veya uzun süreli kanama riskini artırır. Kanda çok fazla trombosit olması, ciddi ve yaşamı tehdit edici olabilen anormal kan pıhtılaşmasına neden olabilir. Trombositler, kemik iliğinde megakaryositler olarak bilinen üç tip kan hücresinden biridir. Pıhtılarda trombosit oluşumuna adezyon denir. Örneğin yanlışlıkla parmağınızı keser ve bir kan damarına zarar verirseniz kan akmaya başlar. Kanamayı durdurmak için hasarlı damarın içindeki trombositler yaralanma bölgesine yapışır ve daha fazla yardım için kimyasal sinyaller gönderir. Daha fazla trombosit geldiğinde bir pıhtı oluşur. Kan damarı duvarında bir tıkaç veya pıhtı oluştuğunda, pıhtılaşma faktörleri devreye girer ve ardından pıhtıyı birbirine bağlamak için fibrin ekler.

Anahtar Kelimeler: Plazma, Plakalar, Yapi ve Fonksiyon



PLASMA AND ITS COMPOSITION, PLATELETS, STRUCTURE, AMOUNT AND FUNCTION

Abstract

Blood, lymph and intercellular fluid are called the internal environment of the body. More specifically, blood refers to the cell-free internal fluid environment of the body or the internal environment of the body consisting of blood plasma and dependent cells circulating in the vascular system. Clotted blood consists of thrombus and some plasma proteins. Serum is the clear liquid part of plasma from which fibrinogen has been removed. Blood is one of the integrating systems of the body. Various fluctuations in the state of individual organs of the body cause changes in the blood system and vice versa. Platelets are blood cells responsible for blood clotting. If the vessel wall is damaged, platelets travel to the site of damage and form a plug or clot to stop the bleeding. A low platelet count increases the risk of uncontrolled or prolonged bleeding. Having too many platelets in the blood can cause abnormal blood clotting, which can be serious and life-threatening. Platelets are one of the three types of blood cells in the bone marrow known as megakaryocytes. The formation of platelets in a clot is called adhesion. For example, if you accidentally cut your finger and damage a blood vessel, the blood will start to flow. To stop bleeding, platelets inside the damaged vessel stick to the site of the injury and send chemical signals for more help. As more platelets arrive, a clot forms. Once a plug or clot forms in the blood vessel wall, clotting factors kick in and then add fibrin to the clot to bind it together.

Keywords: Plasma, Plates, Structure and Function

Kan ve plazmanın fizyolojik özellikleri:

Kan, lenf ve hücreler arası sıvı vücudun iç ortamı olarak adlandırılır. Daha spesifik olarak, kan, vücudun hücreli iç sıvı ortamını veya kan plazması ve vasküler sistemde dolaşan bağımlı hücrelerden oluşan vücudun iç ortamını ifade eder. Pıhtılaşmış kan, trombus ve bazı plazma proteinlerinden oluşur. Serum, fibrinojenin uzaklaştırıldığı plazmanın berrak sıvı kısmıdır. Kan, vücudun bütünleştirici sistemlerinden biridir. Vücudun bireysel organlarının durumundaki çeşitli dalgalanmalar, kan sisteminde değişikliklere neden olur ve bunun tersi de geçerlidir (Arıkan F., Özçaka Ö., Bıçakçı N.,2007).Bu nedenle, bir kişinin sağlığını ve hastalığını değerlendirirken, harflerle kan - hematolojik göstergeleri karakterize eden parametreleri incelerler. Kan, lenf ve hücreler arası sıvı birlikte organizmanın iç ortamını oluşturur. Kan sistemi çalışması, 1939'da G. F. Lang tarafından oluşturuldu. O, bu sisteme; 1) damarlarda dolaşan ve kan depolarında bulunan kan; 2) kan inceltici; 3) kana zarar veren organlar; 4) düzenleyici nöro-hümorale sistemi içeriyordu (Tsoi W.C.,2020).

Kan birçok farklı işlevi yerine getirir. Kanın çoklu işlevleri sadece plazma ve kan hücreleri tarafından değil, aynı zamanda tüm doku ve organlara kan taşıyan kan damarlarında dolaşan kanın durumu ile belirlenir. Kan, vücut ve çevre arasında bir bağlantı oluşturur. Kanın ana işlevi, taşıma, hemostatik, savunma ve hemokoagülasyon işlevlerini içerir. Bunların dışında, vücudun iç ortamının bir parçası olarak kan, vücudun diğer işlevlerinin aktivitesinin ana parçasıdır. Örneğin kanın uygulanması, solunum, beslenme ve metabolizma, atılım, hormonal ve sıcaklık düzenlenmesi, bağışıklık tepkisi ile yakından ilgilidir. Dolayısıyla yukarıda bahsettiklerimizden yola çıkarak, vücudun iç ortamının ana parçası olan kanın işlevlerini aşağıdaki gibi yerine getirdiğini söyleyebiliriz. Kan, vücutta oksijen ve karbondioksitin birleşmesi ve taşınmasını sağlayarak solunuma katılır (Arıkan F., Özçaka Ö., Bıçakçı N.,2007).



Metabolizmanın son ürünlerini boşaltım organları yoluyla vücuttan uzaklaştırarak atılıma katılır; mikroorganizmalar, virüsler, bunların kana giren toksinleri, diğer yabancı cisimlerin neden olduğu bulaşıcı hastalıklardan sonra oluşan antikorlar - bağışıklık organları veya antikorlar, daha doğrusu kana giren toksinlere karşı antitoksinler - lökositlerin fagositik aktivitesi, hücrel bağışıklık ve oluşumuna katılım kandaki antikorlar aracılığıyla hümoral bağışıklık yapar (Öztürk MK., Bozkurt FY.,2005).

Kan, karaciğerden geçerken vücuda enerji verir ve akciğerlerden geçerken vücudu soğutur. Kan ayrıca organlar arasında hümoral düzenlemeyi gerçekleştirmek için hormonları ve diğer fizyolojik olarak aktif maddeleri kan yoluyla taşır. Kan, vücut için önemli olan ozmotik basınç, şeker içeriği, PH ve iyon içeriğinin istikrarlı bir şekilde korunmasını sağlar; kan, vücudun tüm hücrelerine besinler - glikoz, amino asitler, yağlar, vitaminler, mineraller ve su sağlayarak beslenme işlevini yerine getirir. Kanın yaratıcı işlevi, plazmanın şekillendirilmiş elemanları ve makromolekülleri tarafından gerçekleştirilir - doku yapısının restorasyonu ve bakımı, hücre farklılaşma derecesinin düzenlenmesi ve hücreler arası bilginin aktarılması. Vücudun normal çalışması için kandaki su ve tuz miktarı, asit-alkali dengesi, ayrıca ozmotik basınç, şeker, protein, yağ, mineral maddeler, PH, ve iyon içeriği sabittir. Diğer sıvılardan farklı olarak kanın kendine has fiziksel özellikleri vardır.

Kan vücudun beslenmesine, dokulardaki hücrelere, solunum süreçlerine katılır, koruyucu rol oynar ve düzenleme görevi vardır. Vücudumuzdaki hareketi sırasında onu sıcak tutar, soğutur, dokuları kanla besler, korur, enerji verir ve toksik maddelerin vücuttan atılmasını sağlar. Organlar arasındaki iletişimin neredeyse tamamını alır. Ayrıca kandaki fibrin lifleri damarın hasarlı kısmına birikerek bir ağ oluşturarak damarlarda oluşan hasarı ortadan kaldırır. Böylece vücut düzenli olarak yenilenir. 60 kg. 5 lt ağırlığındaki bir kişinin damarlarında. kan dolaşır. Kalp bu miktardaki kanı vücutta bir dakika içinde kolaylıkla dolaştırır. Ancak, fiziksel güç gerektiğinde veya egzersiz sırasında kan, bir dakikada bu miktarın beş katına kadar dolaşabilir.

Soluduğumuz hava hayatımız için en önemli faktördür. Bir alevin odunu yakmak için oksijene ihtiyacı olduğu gibi, hücrelerin de enerji üretmek için şekeri parçalamak için oksijene ihtiyacı vardır. Bunun için akciğerlerden kaslara oksijen verilmesi gerekir. Karmaşık dolaşım sistemimiz bu görevi kendi üzerine alır. Organlara oksijen taşıma görevi, kırmızı kan hücrelerinin içindeki hemoglobinin tarafından gerçekleştirilir. Her iki tarafı düz, yuvarlak ve içbükey olan eritrositlerden sadece bir tanesi yaklaşık 300 milyon hemoglobin taşır. Kırmızı kan hücreleri - hemoglobinin, mükemmel bir çalışma sistemine sahiptir. Başlıca işlevi kanda oksijen ve karbondioksit taşımaktır. Bu işlevi en güzel şekilde yerine getirir. Kırmızı kan hücreleri doku hücrelerine oksijen taşırken dokularda üretilen karbondioksit ile birleşerek akciğerlere taşır. Akciğerlerde karbondioksit hemoglobinden ayrılarak vücuttan atılır.

Hemoglobin molekülleri oksijenle birlikte nitrojen monoksit (NO) taşır. Bu gaz kanda taşınmasaydı kan basıncı sabit kalmazdı. Hemoglobin, nitrik oksit yardımıyla dokulara verilen oksijen miktarını da kontrol eder.

Trombositlerin işlevleri:

Trombositler, kırmızı kemik iliği ve dalakta bulunan megakaryositlerde oluşur. Kan yaymasında kan trombositlerinin boyutu 3-5 µm, dolaşımdaki kandaki miktarları 150-405x10⁹ / veya sağlıklı insanların kanındaki trombosit sayısı 220.000-400.000'dir. Fiziksel çalışma nedeniyle gün boyunca sayıları artar ve geceleri azalır. Trombositlerin üçte ikisi kanda bulunur ve geri kalanı dalakta



depolanır. Trombositlerin ömrü 8-12 gündür. Yaşlı trombositler dalak, karaciğer ve kemik iliğinde fagositoza uğrar, yani fagositler tarafından yakalanır ve sindirilir.

Kanda dolaşan trombositler kanama sırasında aktive olur. Aktive trombositler, kanın pıhtılaşmasında ve hasarlı damar duvarının bütünlüğünü geri kazanmada rol oynar. Aktive trombositlerin en önemli özelliklerinden biri, kan damarı duvarının yapışmasının yanı sıra karşılıklı yapışma ve agregasyon yetenekleridir. Kandaki trombosit sayısındaki artışa trombotoz, azalmasına ise trombopeni denir.

Fizyolojik koşullarda trombositler pasif durumda yani kanda serbestçe dolaşırlar ve birbirlerine yapışmazlar. Bununla birlikte, kan damarları hasar gördüğünde, trombositler, kan pıhtılaşmasının plazma faktörleriyle birlikte, kanamayı önleyen bir kan pıhtısı - bir trombüs - oluştururlar. Kan trombositlerinin damarın hasarlı kısmına çarpması ve parçalanması sonucunda vazokonstriktör madde-serotin salınır. Kanamayı durdurmak 3 aşamada gerçekleşir. 1. İlk olarak, kan damarlarının açıklığının daralması meydana gelir. 2. Daha sonra damardaki hasar bölgesinde trombositler damar duvarına birleşir, birbirine yapışır ve trombosit hemostatik tıkaç oluşturur. Bu olay tersine çevrilebilir. Böylece zayıf bağlanmış trombositler koparak kan dolaşımına geri dönebilir (Infanti L., 2019). 3. Son olarak, çözünür fibrinojen, üç boyutlu bir ağ oluşturan çözünmeyen fibrine dönüştürülür. Eritrositler dahil kan hücrelerinde bulunur; bu fibröz - kırmızı bir trombüs veya kırmızı pıhtıdır (. Harvala H., 2019).

Eritrositler ve lökositler gibi trombositler de kanda belirli işlevleri yerine getirir. Eritrositlerin işlevi hücrelere ve dokulara oksijen sağlar, lökositlerin işlevi vücudu yabancı cisimlerden korur ve trombositlerin ana işlevi kanın pıhtılaşmasına katılmaktır. Trombositler küresel veya oval şekildedir ve dalak ve kemik iliğinde oluşur. Trombositler çekirdeğe sahip değildir. 1 mm³ insan kanında 150-400 bin trombosit bulunur. Ancak bunların miktarı değişebilir. Trombositlerin ömrü 35 gündür. Yoğun kas çalışması sırasında veya yoğun antrenman sonrasında kandaki trombosit miktarı 35 kat artar. Dalakta trombosit yıkımı meydana gelir (Зарубин М.В., 2016).

Trombositler kanın pıhtılaşmasından sorumlu kan hücreleridir. Damar duvarı hasar görürse, trombositler hasar bölgesine gider ve kanamayı durdurmak için bir tıkaç veya pıhtı oluşturur. Düşük trombosit sayısı, kontrolsüz veya uzun süreli kanama riskini artırır. Kanda çok fazla trombosit olması, ciddi ve yaşamı tehdit edici olabilen anormal kan pıhtılaşmasına neden olabilir (. Буркитбаев Ж.К., 2019).

Trombositler, kemik iliğinde megakaryositler olarak bilinen üç tip kan hücresinden biridir. Pıhtılarda trombosit oluşumuna adezyon denir. Örneğin yanlışlıkla parmağınızı keser ve bir kan damarına zarar verirseniz kan akmaya başlar. Kanamayı durdurmak için hasarlı damarın içindeki trombositler yaralanma bölgesine yapışır ve daha fazla yardım için kimyasal sinyaller gönderir. Daha fazla trombosit geldiğinde bir pıhtı oluşur. Kan damarı duvarında bir tıkaç veya pıhtı oluştuğunda, pıhtılaşma faktörleri devreye girer ve ardından pıhtıyı birbirine bağlamak için fibrin ekler (Давыдова Л.Е. 2017). Trombosit sayısını, boyutunu ve sağlığını değerlendirmek için klinik bir kan testi yapılır. Trombositler için spesifik laboratuvar belirteçleri aşağıdaki gibidir:

Trombosit sayısı (PLT)

Bu gösterge sahip olduğumuz trombosit sayısıdır. Düşük: mikrolitre başına 150.000'den az trombosit Normal: Mikrolitre başına 150.000 ila 450.000 trombosit. Yüksek: mikrolitre başına 500.000 ila 1.000.000 trombosit. Trombosit sayısı, olası kanama ve pıhtılaşma sorunlarını tahmin



etmek için ameliyat öncesi ve sonrası önemli bir sayıdır. Bu tedaviler kemik iliğinde trombosit üretimini engelleyebileceğinden, kemoterapi ve radyasyon tedavisi sırasında da önemli bir endikasyondur (Ашуралиев Н.К,2018).

Ortalama Corpuscular Volume (MPV)

Ortalama korpüsküler hacim (MPV), trombositlerin ortalama boyutudur. Yeni trombositler eskilerinden daha büyüktür, bu nedenle sayılarının artması hızlı üretilip salınması anlamına gelirken, az sayıda olması kemik iliğindeki üretimin değiştiği anlamına gelir Trombositler kanda 8-10 gün yaşar.

Trombosit Anizositozu (PDW)

PDW, trombositleri etkileyen koşulları gösterebilen trombosit boyutundaki bir değişiktir. Trombosit fonksiyon testleri, antiplatelet ilaçları izlemek için ve aşırı kanama belirtileri veya semptomları varsa da kullanılabilir.

Bir kan testinde 150.000 hücre/ml'den düşük trombosit sayısı, kanda düşük PLT olarak adlandırılır. Bu durum için başka bir isim trombositopenidir. Birçok sağlık sorunu kanda düşük trombosit sayısına neden olabilir. Trombositopeni, trombosit üretiminin azalması, trombosit yıkımının artması ve kanın normalden daha fazla seyreltilmesi gibi bir birim kandaki trombosit sayısı azaldığında ortaya çıkabilir. Belirli hastalıklara ek olarak, belirli ilaçlar, beslenme veya belirli tedaviler trombosit sayısını azaltabilir.

Düşük trombosit nedenleri

Trombosit sayısı düşük olan hastalarda bu duruma neden olabilecek birçok durum vardır. Çeşitli akut veya kronik hastalıklar, gebelik, kan transfüzyonu, sepsis, kullanılan bazı ilaçların yan etkileri, folik asit veya vitamin B12 eksikliğinden kaynaklanan anemi, aplastik anemi, immünolojik ve/veya romatolojik hastalıklar, vb.

Trombosit (PLT) yüksekliği

Kanda yüksek bir PLT, trombosit sayısının 450.000 hücre/ml'yi aştığı bir durumdur. Trombosit yüksekliği veya trombositoz olarak adlandırılan bu durumun gelişiminde trombositopeninin aksine kanın pıhtılaşma eğilimi artar. Kan hücresi üretiminin ve miktarının düzenlenmesinde veya hormonal denge ile ilgili mekanizmalarda yaşanan problemler trombosit üretiminin artmasına neden olabilir. Aynı şekilde kullanılan bazı ilaçlar veya farklı hastalıklar trombosit sayısının artmasında etkili olabilir (. Ашуралиев Н.К,2018). Trombosit sayısında artışa veya trombositozu yol açabilecek çeşitli nedenler vardır. Kandaki sıvı miktarının azalmasına bağlı trombosit oranının artması, fizyolojik olarak aşırı trombosit üretimi, demir eksikliğine bağlı trombosit üretiminin artması. veya trombositlerin yok edilmesinde veya dalağın splenektomi ile çıkarılmasında rol oynayan dalağın işlevinde azalma (Жибурт Е.Б,2019).



Kaynaklar

1. Arıkan F., Özçaka Ö., Bıçakçı N., Trombositten zengin plazma ve kemik grefti ile kombinasyonunun dar kemik içi defektlerde başarısının karşılaştırılması. EÜ Diş Hek. Fak. Derg. 28:151-161, 2007
2. Öztürk MK., Bozkurt FY., Periodontal rejenerasyonda yeni bir yaklaşım: Trombositten zengin plazma. CÜ Diş Hek. Fak. Derg. 8:119-127, 2005
3. Ашуралиев Н.К. Основные критерии выбора тактики лечения при массивной и тяжёлой кровопотере / Ашуралиев Н.К., Баховадинов Б.Б., Мухиддинов Н.Д. // Вестник Академии медицинских наук Таджикистана.- 2018.- Т.8, №2.- С.175-179
4. Буркитбаев Ж.К. Работа служб крови России и Казахстана/ Буркитбаев Ж.К., Чемоданов И.Г., Абдрахманова С.А. и др. // Гематология. Трансфузиология. Восточная Европа.- 2019. -Т. 5, № 4. -С. 395-399
5. Давыдова Л.Е. Переливание донорских тромбоцитов/ Давыдова Л.Е., Губанова М.Н., Аюпова Р.Ф. и др. // Якутский медицинский журнал.- 2017.- Т.58, №2.- С.41-45
6. Жибурт Е.Б. Вопросы гемостаза в правилах заготовки, хранения, транспортировки и клинического использования донорской крови и ее компонентов// Тромбоз, гемостаз и реология.- 2019.- №4.- С. 9-12
7. Зарубин М.В. Обеспечение эффективности и безопасности переливания тромбоцитов/ Зарубин М.В., Губанова М.Н., Гапонова Т.В. и др. // Вестник Национального медико-хирургического центра им. Н.И.Пирогова.- 2016.- Т.11, №3.- С.118-125
8. Harvala H. Hepatitis E virus in blood donors in England, 2016 to 2017: from selective to universal screening/ Harvala H., Hewitt P.E., Reynolds C. et al. // Euro Surveill.- 2019.- Vol.24, №10.- P.1800386
9. Infanti L. Clinical impact of amotosalen-ultraviolet A pathogen-inactivated platelets stored for up to 7 days/ Infanti L., Holbro A., Passweg J. et al. // Transfusion.- 2019.- Vol. 59, №11.- P.3350-3361
10. Li G. Full annotation of serum virome in Chinese blood donors with elevated alanine aminotransferase levels/ Li G., Zhou Z., Yao L. et al. // Transfusion.- 2019.- Vol. 59, №10.- P.3177-3185
11. Malvik N. ABO-incompatible platelets are associated with increased transfusion reaction rates/ Malvik N., Leon J., Schlueter A.J. // Transfusion.- 2020.- Vol. 60, №2.- P. 285-293
12. Tsoi W.C. Hepatitis E virus infection in Hong Kong blood donors/ Tsoi W.C., Zhu X., To A.P., Holmberg J. // Vox Sang.- 2020.- Vol. 115, №1.- P. 11-17



TROMBOSİTTEN ZENGİN PLAZMANIN ENDOKRİN SİSTEM ÜZERİNE ETKİLERİ VE MORFOLOJİK ÖZELLİKLERİ

Kərimova Rəna Cabbar kızı

Dr., Azərbaycan Tıp Universitesi, Deneysel Cerrahi Anabilim Dalı, Uzman Araştırmacı, Tıpta Felsefe Doktoru

Ağayeva Asiya Hacı kızı

Azərbaycan Tıp Universitesi, Normal Fizyoloji Anabilim Dalı, Yrd. , Biyolojide Felsefe Doktoru, Doçent

Tulumbacı Cəfərova Nərminə İlham kızı

Dr., Bakü Tıp Fakültesi No. 1, Normal insan anatomisi ve fizyolojisi ve Patolojinin temelleri öğretmeni

Məşədiyeva Bayramova Səbinə Ənvər kızı

Dr., Azərbaycan Tıp Universitesi, 2. İç Hastalıkları Anabilim Dalı, Tıpta Felsefe Doktoru, Doçent

Cəfərova Qumru Kamil kızı

Azərbaycan Tıp Universitesi, Morfoloji Anabilim Dalı, Uzman Araştırmacı

Özet

Kan vücutta çeşitli işlevleri yerine getirir. Hücrelere besin ve oksijen iletir, değişimin son ürünlerini boşaltım organlarına getirir, biyolojik olarak aktif maddeler sayesinde organ ve sistemlerin fonksiyonlarını hümorale bir şekilde düzenler, vücut ısısının sabit tutulmasına katılır, vücudu korur. toksik maddeleri ve yabancı cisimleri uzaklaştırarak vücudu zararlı etkilerden korur. Plazma proteinleri doğada geçirgendir, bu nedenle ozmotik basıncı doğrudan etkileyen vasküler bölmede depolanırlar. Büyük moleküller olan bu proteinler, yarı geçirgen bir zarla yayılmadıklarında, bu ortamdaki varlıkları iyon parçacıklarının dağılımını değiştirir. Bu özellik elektrolit düzenlemesindeki rolünü belirler. Bu tür hidrostatik basıncı korumak için plazmaya daldırılan proteinler, ozmotik basınç üzerinde doğrudan bir etkiye sahiptir ve bu etki, bu büyük moleküllerin kan damarları üzerindeki etkisiyle yakından ilişkilidir. Proteinler basınç uygular, çünkü suyun hareketi bir gradyanla hareket eder, yani daha büyük bir potansiyel alandan daha azına yönlendirilir, bu nedenle insan vücudundaki su her zaman bazı çözülmüş maddelerin daha yüksek konsantrasyonda olduğu yere gidecektir.

Bir bez, salgı veya boşaltım epitel hücrelerinden oluşan bir organdır. Epitel dokusu bezin ana kütlelerini, bağ dokusu ise stromasını oluşturur. Endokrin sistem iç salgı bezleri, dış salgı bezleri ve karışık salgı bezlerinden oluşur. Salgı bezleri arasında insanlarda en temel işleve sahip bezler tiroid bezi ve böbrek üstü bezidir. Sinir sistemi olmayan basit hücreli hayvanların vücudundaki fizyolojik süreçler ve dış çevre ile iletişimlerini vücut sıvılarında bulunan kimyasallar tarafından düzenlenir. Bu tür düzenlemeye kimyasal veya hümorale düzenleme denir. Fizyolojik olarak bu aktif kimyasal maddeler tek hücrelilerde plazma, çoklu hücrelerde özel damarlar yoluyla yayılır.

Anahtar Kelimeler: Plaka, Plazma, Endokrin sistem üzerine etkisi



EFFECTS OF PLATELET-ENRICHED PLASMA ON THE ENDOCRINE SYSTEM AND ITS MORPHOLOGICAL CHARACTERISTICS

Abstract

Blood performs various functions in the body. It delivers nutrients and oxygen to the cells, brings the last products of the exchange to the excretory organs, regulates the functions of organs and systems in a humoral way thanks to the biologically active substances, participates in keeping the body temperature stable, protects the body from harmful effects by removing toxic substances and foreign bodies. Plasma proteins are permeable in nature, so they are stored in the vascular compartment, which directly affects the osmotic pressure. When these proteins, which are large molecules, do not diffuse through a semipermeable membrane, their presence in this medium changes the distribution of ion particles. This property determines its role in electrolyte regulation. Proteins immersed in plasma to maintain this type of hydrostatic pressure have a direct effect on osmotic pressure, and this effect is closely related to the effect of these large molecules on blood vessels. Proteins exert pressure, because the movement of water moves with a gradient, that is, it is directed to less than a larger potential field, so the water in the human body will always go to where it is a higher concentration of some dissolved substance .

A gland is an organ composed of secretory or excretory epithelial cells. Epithelial tissue forms the main mass of the gland, and connective tissue forms its stroma. Endocrine system consists of internal secretion glands, external secretion glands, and mixed secretion glands. Among the secretory glands, the glands with the most basic function in humans are the thyroid gland and the adrenal gland. Physiological processes in the body of simple-celled animals without a nervous system, as well as their communication with the external environment, are regulated by chemicals contained in body fluids. This type of regulation is called chemical or humoral regulation. Physiologically, those active chemical substances diffuse through the plasma in single-cells, and through special vessels in multi-cells .

Keywords: Effect on plates, Plasma, Endocrine system

Kanın fizyolojik özellikleri:

Kan vücudun bir parçası olan yenilenebilir bir dokudur ve bu dokuya giren hücreler sürekli olarak kemik iliğinde üretilir. Hepimizin bildiği gibi kan, enfeksiyona karşı savunma, gaz değişimi ve besin dağılımı gibi birçok organizma türünde hayati işlevleri yerine getirir (Arıkan F., Özçaka Ö., Bıçakçı N.,2007).

Kan, vücudun bağ dokularına ait olan, insanların ve çoğu hayvanın vücudunda dolaşan ve vücutta çeşitli işlevleri yerine getiren kırmızı bir sıvıdır. Kan, lenf ve hücreler arası sıvı ile birlikte vücudun iç sıvı ortamını oluşturur. Kan, hareketi sırasında dokulara oksijen ve besinleri, dokulardan karbondioksiti de akciğerlere ve böbreklere taşır ve büyüklü küçüklü kan dolaşımı ile vücuttaki hareketini tamamlar. Kan, 3-4 haftalık embriyonik yaşamda gelişir. Kan, insan vücut ağırlığının ortalama %7'sini oluşturur. 70 kg ağırlığındaki orta yaşlı bir insanın vücudunda yaklaşık 5 litre kan bulunur (Tynuv M.,2019).

Kan vücutta çeşitli işlevleri yerine getirir. Hücrelere besin ve oksijen iletir, değişimin son ürünlerini boşaltım organlarına getirir, biyolojik olarak aktif maddeler sayesinde organ ve sistemlerin



fonksiyonlarını hümorale bir şekilde düzenler, vücut ısısının sabit tutulmasına katılır, vücudu korur. toksik maddeleri ve yabancı cisimleri uzaklaştırarak vücudu zararlı etkilerden korur (Arıkan F., Özçaka Ö., Bıçakçı N.,2007).

Kan, bileşimine göre Plazma ve Oluşmuş elementler olmak üzere ikiye ayrılır. Plazma, kanın sıvı kısmını ifade eder ve şekilli elemanlar, kanın katı kısmına aittir (Öztürk MK., Bozkurt FY.,2005).

Plazma ve şekilli elemanlar:

Kanın çoğu %55 berrak, renksiz sıvı - plazmadan oluşur. Kan plazmasının yaklaşık %92'si sudur ve %8'i organik ve inorganik maddelerdir. Kan plazması proteinler, yağlar, glikoz, vitaminler, mineral tuzlar ve diğer maddeleri içerir. Kana çeşitli maddeler girmesine rağmen, kimyasal bileşimi her zaman sabit kalır. Plazmanın fiziko-kimyasal özellikleri değiştirilirse, vücut üzerinde olumsuz bir etkisi olabilir. Plazmadaki fibrinojen proteini, kanın pıhtılaşmasında gerekli bileşenlerden biridir. Şekilli elemanlar kanın katı kısmına aittir ve eritrositler (kırmızı kan hücreleri), lökositler (beyaz kan hücreleri) ve trombositlerden (kan trombositleri) oluşur. Oluşan kan elementleri kırmızı kemik iliği hücrelerinde oluşur (Tynuv M.,2019).

Kan damarlardan çıktığında kısa süre sıvı halde kalır; pıhtılaşmayı önlemek için heparin, sodyum sitrat ve etilendiamintetraasetik asit (EDTA) gibi antikoagülanların eklenmesi kullanılır. Ardından, pıhtılaşmamış kan, hücrelerin tüpün dibine yerleştirildiği Wintrobe tüpleri kullanılarak santrifüjlenir. Bu sürecin bir ürünü olarak, sıvıda üç farklı faz gözlemledik: üstte daha az yoğun kehribar rengi (plazma), merkezde küçük beyazımsı bir trombosit fazı ve altta daha yoğun kırmızı hücre faz (Doku G.N.,2019).

Kan plazmasının işlevleri:

İşlevlerinin çoğu, bu sıvıdaki proteinlerin etkisinden kaynaklanmaktadır. Pıhtılaşma, esasen, kan damarlarını tıkayan yoğun, yarı katı bir kütle oluşturduğu bir savunma mekanizmasıdır. Plazma bu sürece müdahale eder çünkü protrombin, fibrinojen ve kalsiyum iyonları gibi önemli bir şekilde müdahale eden üç maddeye katkıda bulunur. Pıhtılaşma sırasında protrombin ve kalsiyum iyonu, fibrinojeni eritrositleri ve lökositleri yakalayan üç boyutlu bir ağ oluşturan çözünmeyen fibrin liflerine dönüştürmekten oluşan bir protein olan trombin oluşturur (Öztürk MK., Bozkurt FY.,2005). Metabolik ve hücreler süreçlerinde üretilen gıda, gaz ve atık ürünlerin taşınmasını sağlar, genel olarak bu taşıma işlevi organlar arasında madde alışverişini düzenler.

Plazma proteinleri doğada geçirgendir, bu nedenle ozmotik basıncı doğrudan etkileyen vasküler bölgede depolanırlar. Büyük moleküller olan bu proteinler, yarı geçirgen bir zarın yayılmadıklarında, bu ortamdaki varlıkları iyon parçacıklarının dağılımını değiştirir. Bu özellik elektrolit düzenlemesindeki rolünü belirler (Dunne E.,2019).

Bu tür hidrostatik basıncı korumak için plazmaya daldırılan proteinler, ozmotik basınç üzerinde doğrudan bir etkiye sahiptir ve bu etki, bu büyük moleküllerin kan damarları üzerindeki etkisiyle yakından ilişkilidir. Proteinler basınç uygular, çünkü suyun hareketi bir gradyanla hareket eder, yani daha büyük bir potansiyel alandan daha azına yönlendirilir, bu nedenle insan vücudundaki su her zaman bazı çözünmüş maddelerin daha yüksek konsantrasyonda olduğu yere gidecektir (Tynuv M.,2019).

Plazma proteinleri söz konusu olduğunda, kan plazmasında interstisyel sıvıdan daha yüksek bir konsantrasyonun varlığı, bu sıvıdaki suyun eğilmesine neden olur, bu da kılcal duvarın her iki tarafındaki su basıncını düzenlemek için girmesi gerekir. Bu sayede kişinin plazma hacmi ve toplam



kan hacmi korunur. Plazma Kanın bir cam tüpte Heparin veya Na-sitrat ile santrifüj edilmesinden sonra çökelen kan üzerinde oluşan berrak kısım kan serumudur. Fibrinin uzaklaştırıldığı kanın plazma kısmına kan serumu denir. Plazmanın aksine, kan serumu kanın pıhtılaşmasında rol oynayan bir dizi plazma faktörü içermez - 1-fibrinojen, 2-protrombin, 3-proakselerin ve 4-antihemofilik faktör. Plazma, proteinler, karbonhidratlar, yağlar, lipoproteinler, elektrolitler, hormonlar ve diğer kimyasal bileşikler içeren açık sarı bir sıvıdır. 70 kg olan bir insanda plazma hacmi vücut ağırlığının %5'i, vücuttaki su miktarı ise %7,5'tir.

Plazmanın %90-92'si su, %10'u suda çözünen maddeler, %9'u organik maddeler ve %1'i inorganik maddelerdir. Protein, katı maddenin 2/3'ünü oluşturur ve küçük molekül ağırlığı ve elektrolitler 1/3'ünü oluşturur. Plazmanın kimyasal bileşimi hücreler arası sıvıya benzer olmasına rağmen, katyonlar Na⁺, anyonlar Cl⁻-HCO₃⁻ ve plazmadaki protein konsantrasyonu yüksektir (70g/l). Plazmada, esas olarak karaciğerden gelen birkaç yüz farklı protein vardır. Plazma proteinlerinin işlevleri çok çeşitlidir. Bunlar arasında albumin proteini (40g/l, Mr*60-65kD), kanın onkotik basıncını (25 mm Hg.st. veya 3.3 kPa) belirler. Kanın onkotik basıncı, hücreler arası sıvınınkinden 5 kat daha yüksektir.

Bu nedenle hipoalbuminemi sırasında böbreğe bağlı böbrek tümörü, açlığa bağlı açlık tümörü gelişir. Kandaki globulin miktarı 30 gramdır. Bu proteinler yani albumin, globulin indeksi (A/Q) normal sağlıklı bir insanda 1.5/2.3'tür. Bu proteinlerden kan plazmasında oluşan enzimlere örnek olarak amilaz, lipaz, fosfataz, proteaz, γ - globulin - yani immünooglobulinler (IgA, D, E, G, M) tıpta virüsleri, bakterileri ve bunların toksinlerini nötralize etmek için kullanılır. Albuminler karaciğerde, globüminler ise karaciğere ek olarak lenf düğümlerinde, dalakta ve kemik iliğinde sentezlenir (Азимова М.Х.,2017).

Endokrin bezleri:

Salgı bezleri tarafından salınan biyolojik olarak aktif maddelere hormon denir. Hormonlar kan yoluyla vücudun her yerine taşınır ve birçok organ sisteminin fonksiyonlarını ve tüm vücudun hayati aktivitesini etkiler. Hormonlar metabolizma, büyüme ve gelişme süreçlerini düzenler. Bazı hormonların herhangi bir organ sisteminin işlevleri üzerinde daha büyük etkisi vardır. Bu tür organlara hedef organlar denir. Hedef organların hücre zarları hormonlara çok duyarlıdır. Örneğin, seks hormonları üreme sisteminin büyümesini ve gelişmesini hızlandırır. Tüm bezlerin çalışması birbirleriyle yakından ilişkilidir. Herhangi bir bezin az ya da çok hormon salgılaması, başka bir bezin işlevini güçlendirir veya zayıflatır. Şimdiye kadar insanlarda 50'den fazla hormon tanımlanmıştır. Bir bez, salgı veya boşaltım epitel hücrelerinden oluşan bir organdır. Epitel dokusu bezin ana kütlelerini, bağ dokusu ise stromasını oluşturur. Endokrin sistem iç salgı bezleri, dış salgı bezleri ve karışık salgı bezlerinden oluşur. Salgı bezleri arasında insanlarda en temel işleve sahip bezler tiroid bezi ve böbrek üstü bezidir (Азимова М.Х.,2017).

Sinir sistemi olmayan basit hücreli hayvanların vücudundaki fizyolojik süreçler ve dış çevre ile iletişimleri vücut sıvılarında bulunan kimyasallar tarafından düzenlenir. Bu tür düzenlemeye kimyasal veya hümorale düzenleme denir. Fizyolojik olarak bu aktif kimyasal maddeler tek hücrelilerde plazma, çoklu hücrelerde özel damarlar yoluyla yayılır (Аксельрод Б.А.,2018).

Sinir sisteminin oluşumu ile bağlantılı olarak, kimyasal olarak aktif maddeler sinir elemanları ile temas eder ve sonuç olarak bir nöro-hümorale düzenleme yöntemi ortaya çıkar. Sinir sisteminin etkisi altında metabolizmanın bir sonucu olarak oluşan aktif kimyasal maddelere, örneğin sempatik, asetilkolin, histamin vb. Sinir sistemini tahriş etme yeteneğine sahip araçlar denir.



Morfolojik özellikler:

Basit hayvanlarda araçlar bir hücreden diğerine hareket eder ve yavaş hareket eder. Bu tür araçlara yerel etkinleştiriciler denir. Filogenезin sonraki aşamalarında, uzak aktivatörler adı verilen araçlar ortaya çıkar; kan ve lenf damarlarında dolaşırlar ve çıkış yerinden uzaktaki organları hızla etkilerler. Bu tür aktivatörler, endokrin bezleri veya endokrin organları adı verilen özel türevlerde üretilir. İç salgı bezlerinin morfolojik özelliklerinden biri de kan damarlarından zengin olmalarıdır; örneğin tiroid bezinin 100 cm³'ünden bir dakikada 560 cm³ kan akarken, aynı miktarda böbrek kütesinden sadece 100 cm³ kan geçer. Ayrıca endokrin bezlerinin kan kılcal damarları bez hücreleri ile yakın temas halindedir. Özel bir bağ dokusu zarının bulunmadığı kılcal duvarın endotel tabakası doğrudan bez hücrelerinin üzerine oturur. Ek olarak, burada kılcal genişlikler oluşur - sinüzoidler; sinüzoidlerin duvarları bazı yerlerde kırılmış gibidir, bu nedenle bu yerlerde hücreler kılcal damarların açıklıklarına girer. Sinüzoidlerde kan yavaş aktığı için bez hücrelerinin kanla temas süresi artar; Bütün bunlar hormonun kana girmesini sağlar.

İç salgı bezlerinde salgılanan ürün, özel maddeler grubuna aittir. Hormonların belirli organlar üzerinde özel bir etkisi vardır - seçici bir özellik ve küçük miktarlarda salgılanmasına rağmen güçlü bir etki. Bazıları doku metabolizmasını destekler - asimilasyon ve disimilasyon süreçlerini ve diğer kısmı - hormonozomlar organların gelişmesini ve büyümesini sağlar. Bazı hormonlar bu veya diğer bezi uyarır ve salgılarını arttırırken, diğerleri ise tam tersine organların aktivitesini engeller. Böylece iç salgı bezlerinden salgılanan hormonlar kan ve lenf yoluyla tüm vücuda yayılarak fizyolojik ve gelişimsel süreçleri düzenler; bedende belli bir uyum-ilişki yaratır.

Endokrin bezleri ve sinir sistemi, özellikle otonom sinir sistemi, işlevsel olarak birbiriyle ilişkilidir. Bir yandan sinir sistemi vücudun tüm organlarının fonksiyonlarını düzenler, iç salgı bezlerini tahriş eder ve salgılarını düzenler; öte yandan endokrin bezlerinin hormonları periferik sinir uçlarını ve sinir merkezlerini tahriş eder. Örneğin, sempatik sinirler tahriş olduğunda, adrenal bezin beyin maddesinin ürünü - adrenalini adı verilen hormon artar, böylece kandaki adrenalini miktarı artar; ve adrenalini sempatik sinirleri tahriş eder, bunun sonucunda kan damarları daralır, kan basıncı yükselir, kalp çarpıntısı görülür, vb (Кузнецов С.И. и др.2020). İç salgı bezlerinin sinir sistemi ile ilişkisi, bazılarının, örneğin hipofiz bezi, hipofiz bezi, böbrek üstü bezinin beyin maddesi ve kromafin cisimciklerinin mayadan geliştiği gerçeğiyle de kanıtlanabilir. sinir sisteminin. Bilindiği gibi sinir sistemi ve iç salgı bezleri birbirleriyle yakın iletişim halindedirler, vücutta hem sinir hem de kimyasal-hümmoral ilişki devam eder, bu nedenle bu iki sisteme birlikte Nöro-hümmoral sistem denir (Лазарева Е.Ю.,2019).Ek olarak, iç salgı bezlerinin birbirleriyle çok karmaşık bir ilişkisi vardır, örneğin, birinin işlevi bozulursa, diğer bezlerde bir işlev değişikliği meydana gelir, bunun sonucunda vücutta devam eden korelasyon - "endokrin" organ dolaşımı" bozulur (Domanović D.,2017).

Endokrin bezleri yaşam döngüsü boyunca değişikliklere uğrar. Bazıları belli bir dönemde görevlerini ifade ederler; örneğin, tiroid bezi 15 yaşından sonra gelişimi tersine çevirir. Diğer kısım, örneğin yumurtalıklarda oluşan sarı gövde periyodik olarak ortaya çıkar.



Kaynaklar

1. Arıkan F., Özçaka Ö., Bıçakçı N., Trombositten zengin plazma ve kemik grefti ile kombinasyonunun dar kemik içi defektlerde başarısının karşılaştırılması. EÜ Diş Hek. Fak. Derg. 28:151-161, 2007
2. Öztürk MK., Bozkurt FY., Periodontal rejenerasyonda yeni bir yaklaşım: Trombositten zengin plazma. CÜ Diş Hek. Fak. Derg. 8:119-127, 2005
3. Азимова М.Х. Изменения маркеров активации донорских тромбоцитов при хранении после проведения инактивации патогенов с помощью технологии амтосален и ультрафиолетовое облучение спектра А / Азимова М.Х., Гапонова Т.В., Галстян Г.М. и др. // Гематология и трансфузиология.- 2017.- Т. 62, № 4.- С. 197-203
4. Аксельрод Б.А. Клиническое использование эритроцитсодержащих компонентов донорской крови. Гематология и трансфузиология/ Аксельрод Б.А., Балашова Е.Н., Баутин А.Е. и др. // 2018.- Т. 63, №4.- С. 372-435
5. Кузнецов С.И. и др. Спорное и бесспорное в рекомендациях по переливанию эритроцитов/ Кузнецов С.И., Аверьянов Е.Г., Хамитов Р.Г. и др. // Трансфузиология.- 2020.- Т.21, №2.- С. 161-176
6. Лазарева Е.Ю. Возможности трансфузионной терапии в хирургической практике у больных с циррозом печени (обзор литературы)/ Лазарева Е.Ю., Колосков А.В. // Вестник хирургии им. И.И. Грекова. 2019.- Т. 178, № 4.- С. 76-80
7. Doku G.N. Frequency of ABO/Rhesus (D) blood groupings and ethnic distribution in the Greater-Accra region of Ghana, towards effective blood bank inventory/ Doku G.N., Agbozo W.K., Annor R.A. et al. // Int J Immunogenet.- 2019.- Vol. 46, №2.- P. 67-73
8. Domanović D. Hepatitis E and blood donation safety in selected European countries: a shift to screening / Domanović D., Tedder R., Blümel J. et al. // Eurosurveillance. – 2017. - № 22(16).- P. 30514
9. Dunne E. Blood group alters platelet binding kinetics to von Willebrand factor and consequently platelet function/ Dunne E., Qi Q.M., Shaqfeh E.S. et al. // Blood.- 2019.- Vol. 133, №12.- P. 1371-1377
10. Tynuv M. Quality improvement with platelet additive solution for safer out-of-group platelet transfusions // Tynuv M., Flegel W.A. / Immunohematology.- 2019.- Vol. 35, №3.- P.108-115



THE EFFECT OF ALOE VERA ON INTERLEUKIN-6 LEVELS IN RATS GIVEN ALUMINIUM CHLORIDE

Burcu Gul

Ulku Yerebasan

Fatih Ahmet Korkak

Hande Yuce

Yasin Baykalir

Tuba Parlak Ak

Huseyin Fatih Gul

Firat University, Faculty of Health Sciences, Department of Nursing, Elazig, Turkey

Firat University, Institute of Health Sciences, Department of Veterinary Pharmacology and Toxicology, Elazig, Turkey

Firat University, Institute of Health Sciences, Department of Veterinary Pharmacology and Toxicology, Elazig, Turkey

Inonu University, Faculty of Pharmacy, Department of Pharmaceutical Toxicology, Malatya, Turkey

Balikesir University, Faculty of Veterinary Medicine, Department of Biostatistics, Balikesir, Turkey

Munzur University, Faculty of Health Sciences, Department of Nutrition and Dietetics, Tunceli, Turkey

Kafkas University, Faculty of Medicine, Department of Medical Biochemistry, Kars, Turkey

Abstract

Heavy metals may cause serious damage by accumulating in the body. Aluminium chlorid ($AlCl_3$) is a heavy metal and used medical applications. It is responsible for the oxidative cell damage. It has many side effects on tissues. Aloe vera is known antioxidant and antiinflammatory agent. Proinflammatory cytokines including interleukin-6 (IL-6) play an important role in the development of inflammation. The purpose of this study was to investigate the effect of aloe vera on the serum IL-6 level in rats given aluminium chloride. The forty-four rats were randomly divided into the following 4 groups: the control, aluminium, aloe vera, and aluminium + aloe vera groups. All administrations were made orally by gavage during 8 weeks. $AlCl_3$ was administrated at the dose of 100 mg/kg by gavage and aloe vera drinking was administrated at dose of 2ml/kg by gavage during experimental period. Twelve hours following the last application, all the rats were sacrificed and blood samples were collected. The blood samples were then centrifuged at 2500 g at 4 °C for 10 min and stored at -80 °C until analysis. The IL-6 levels were examined in serum samples. Enzyme-linked immunosorbent assay (ELISA) analysis was applied to measure serum IL-6 levels. Serum IL-6 levels were significantly ($p < 0.05$) higher in the aluminium group than in the control group. Treatment with aloe vera decreased significantly ($p < 0.05$) levels of IL-6. It is suggested that aluminium may lead to increase serum IL-6 levels and treatment of aloe vera can reduce the levels in rats.

Keywords: Aluminium chloride, aloe vera, antiinflammatory cytokine, rat



THE GENOFUND OF CAUCASIAN PERSIMMON (*DIOSPYROS LOTUS L.*) PLANT IN LANKARAN-ASTARA REGION OF AZERBAIJAN

Mammadhuseyn Huseynov

Candidate of Biological Sciences, Associate Professor

Lankaran State University, Science, Biology and Ecology, Lankaran, Azerbaijan

Abstract

Processes occurred in different ecological periods led to the substantial changes in species composition of the plants on the earth. Under current conditions as a result of increase of human impact and pollutant production the biological systems are not able to activate the proper adaptation mechanisms, and these increase the number of species which are in a danger of disappearing. If we look at the history of human activity such a great number of species never came to danger of disappearing within a short period of time. According to experts' opinion, 5-15 % of all the species on the earth will face the danger of disappearing and perishing within close 20-30 years.

Today, there are more than 4200 species of plants in Azerbaijan: According to the local experts about 10% of these species are in a danger of extinction and perishing. Currently there are widely spread species that are about to disappear in natural conditions. It rises questions about variety in adaptation mechanisms of plant species [1]. Under current ecological conditions the problem of preserving rare plant species' genetic stocks in context of the study of biodiversity is very important from theoretical and practical aspects. Taking this into account location of this persimmon species (genus *Diospyros*) in Lankaran-Astara region flora was detected, its biological and ecological characteristics were studied and biochemical determination of its fruits were carried out. By studying the location of Caucasian persimmon (*Diospyros lotus. L*) in biodiversity of the region, different ways of gene stocks conservation and sustainable utilization of the species were investigated and positive results were obtained.

Monitorings (observations, field experiments, expeditions) have been carried on to study the position of this species (genus *Diospyros* -common in the Southern region of Azerbaijan) in the regional flora and its bioecological specifics. for studying the productivity and the chemical composition of the crops biochemical researches were conducted and *in situ* investigations were carried on active collections for maintaining and continuous utilization of the genetic stocks [2].

Keywords: Caucasian persimmon, biodiversity, genefund, genetic diversity

Lankaran - Astara region is divided into two parts according to the type of relief: the foothills and the coastal. Mountain system consists of three longitudinal mountain heights. The flat part, in its turn, is divided into foothills and seaside sections. Being the cavernous regressive-aquedum terraces of the Caspian Sea, the coastal plain is the sea inclined low altitude height. The hydrological conditions of the region are also very suitable for the cultivation of the The Caucasian Persimmon (*Diospyros lotus. L*) plant. There are more than 20 rivers and small river beds here. They take their start from the mountain and flow down. The water mode varies depending on their sources. The flow of water in the rivers varies unevenly, which depends on the seasons of the year. These natural conditions influence the richness and identity of the region's vegetation. This causes the region's floristic nature, endemic and relict forms in the botanical composition. We need to take into consideration the ecological and biological requirements of the region for cultivation of the The Caucasian Persimmon (*DiospyrosL*) plant in order to obtain normal products in the region. The productivity of the The Caucasian Persimmon (*Diospyros lotus. L*) plant is influenced by heat, light, air humidity,



precipitation and wind, Photosynthesis, respiration, growth and development, etc. The factors we mentioned for the processes play a major role. The most feared months for the *Diospyros* plant in Lankaran-Astara region are December-February. This plant is relatively stable to frost. During blooming period, the temperature of the Caucasus is necessary to be 18-20 °C and 18- 22 °C during the first fruiting period. *Diospyros* is a light-loving plant, but it does not stand flat sun rays and eventually breaks down the chloroplasts in the leaves.

The Caucasian Persimmon (*Diospyros lotus. L*) plant does not have so much demanding for the soil. But it is well developed in light, sandy clay, humus-rich yellow mountain forest areas.

Various methods have been used to study the chemical composition of the plant. Vitamin C and other vitamins in the fruits have been determined with the help of Tilmates method. This is a specific method to define the amount of vitamins in a plant and characterized for its accuracy. Alongside with that, the method of iodometrics has been applied. Vitamin K has been defined with the spectral method. The method is based on the absorption of ultra-violet light at the wave lengths of 243, 249, 261, 270, 325 nm for vitamin K₁, 243, 249, 260, 270, 325 nm for vitamin K₂ and 244, 253, 263, 325 nm for K₃. The research was based on the materials collected during the observations in field routes and expeditions within 2019-2022 years. Different forms of morphological, biological and agricultural qualities of Caucasian persimmon (*Diospyros Lotus*) of the Ebenaceae Vent family in different populations have been met throughout the study in the regional biodiversity [4]. The Lankaran-Astara region provides a chance for spreading of Caucasian persimmon in different ecosystems for its mild Climate, the majority of rainfall and sunny days, the existence of the humid air mass. This type has spread about 1500 m above sea level together with oak-tree (*Quercus*), iron tree (*Parrotia persika*), hornbeam in upland and foothill areas. Sometimes it is a smooth-stem tree with the height of 15-20 m or about 30 m in forests. It is a light-demanding plant. In dark places its corona lengthens, the inner part of the corona expands, harvestability gets slow and productiveness decreases. In winter it sheds its leaves. Several analysis and studies carried out show that Caucasian persimmon in iron tree and hornbeam populations has a tighter corona, productiveness and quality of its fruits are higher. Blossoming begins in May and June. The fruits are little about 1-2 cm. Round, long, and conical. It is able to produce virgin fruits (parttonekarp). The fruits are tart till ripening. It ripens in October or November. Ripe fruits are used in a fresh or dried forms. It is known from carried analysis that there exist 24% sugar, 1,6% protein, 0,83 fat, about 54% vitamin C, 0,32% organic acids, 0,15% vaccine items and others in ripe fruits. There exist about 0,004-61 mg different elements, including aluminium, barium, copper, chrome, iron, nickel, silica, strantium, vanadium, phosphorus, magnesium, natrium (sodium), potassium, calcium etc. per 100 gr of dried fruit. For preservation of the gene stocks of Caucasian persimmon which has a rich biochemical content and pharmacological importance, traditional and modern methods have been used. The preservation of the gene pool in a traditional way is basically based on gathering of different collections, creation of seed bank, formation of defence in reserves and nature reserves. Currently the formation of genetic bank with collections is considered useful in three ways: base, active, couple (duplet). In the basic collection a long period conservation is planned, any intervention is limited. In the active collection average intervention is possible for the restoration, reproduction and study of samples (medium-term conservation) [5]. The double collections are kept separate from base collection for solid protection. It is possible to preserve this rare miracle of nature - Caucasian persimmon - by transferring its young shoots from specially protected and continuously controlled area to a natural forest bioarea. After a detailed study of bioecological characters of this plant in the region, it is possible to find the ways of short and long period protection and sustainable utilization by application of modern methods and as a result maintaining the whole health content. During our studies following problems arised about the use of the active collections: shoots gathered in different ecological zones were planted in the same ecological climate in special protected area, cross pollination changed the complement of genotypes, plants needed definite soil composition and year-round care, infections causing different dangerous



illnesses, the possibility of definite decrement of the biological productivity by the influence of different pests [3].

To solve the stated problems, to create enduring forms against the changeable conditions and pathogen effects we continue our scientific researches using modern selection methods. That's why modern biotechnological methods are used.

Literature

1. Mehdiyeva N.P. «Azərbaycanın dərman florasının biomüxtəlifliyi», Bakı,2011
2. Tofiq Məmmədov, Elman İsgəndər, Təriyel Talıbov. Azərbaycanın nadir ağac və kol bitkiləri. Bakı: Elm, 2014, 380 səh.
3. Tofiq Məmmədov, "Azərbaycan dendroflorası II cild", Bakı: -"Səda"-2015
4. Hüseynov.M.B, Şammədov R. Z, Məmmədova Z. A “Preservation of Caucasian Persimmon (*Diospyros lotus L.*) in Gene Fund of Lankaran-Astara Gecion of Azerbaijan”. Simpozium on EuriAsion Biodiversity 23-27 May 2016, Antalya,Turkiye.
5. Hüseynov M.B,Məmmədova Z.A , "The place and importance of the Caucasian Persimmon (*Diasporus lotus L.*) In the southern region of Azerbaijan".Republican Scientific Conference materials, Lankaran. 2017, May 05-06, p.77



KUZULARIN YAŞAMA GÜCÜ ÜZERİNE ANNELİK DAVRANIŞLARININ ETKİLERİ

Funda ERDOĞAN ATAÇ

Şeniz ÖZİŞ ALTINÇEKİÇ

Ege Üniversitesi Ziraat Fakültesi Zootečni Bölümü

Bursa Uludağ Üniversitesi Ziraat Fakültesi Zootečni Bölümü

Özet

Kuzuların yaşama gücü esas olarak anne ve yavru arasında başarılı bir bağ kurulmasına bağlıdır. Sütten kesim öncesi ölümlerin neredeyse yarısı doğum anında veya bir haftalık yaşta meydana gelmektedir. Kuzu ölüm oranı, bir çiftliğin ekonomik yaşayabilirliği üzerinde bariz bir etkiye sahiptir. Bu nedenle kuzuların yaşama gücünün ve refahının artırılmasında doğumdan hemen sonra başlayan ve ortalama 24 saat süren bu hassas dönemde gerçekleşen koyun-kuzu etkileşimi oldukça önemlidir. Yenidoğan kuzuların en savunmasız oldukları ve kuzu kayıplarının en yaygın olduğu bu dönemde koyunlarda annelik davranışının uygun şekilde ve zamanında ifadesi, kuzuların yaşama gücünün artırılmasında ve başarılı bir şekilde yetiştirilmesinde kritik rol oynamaktadır. Annelik yeteneği yüksek hayvanlar, yavrulara beslenme, termoregülasyon, hem immünolojik hem fiziksel koruma, rahatlık ve sosyal öğrenme fırsatları sağlayarak yavrunun hayatta kalmasını teşvik ederler. Bununla birlikte annenin yaşı, gebelik sırasında beslenme durumu, gebelikteki psikolojik durumu, doğum tipi, doğum zorluğu, annelik deneyimi, mizaç ve genotip gibi bazı faktörler annelik yeteneğini etkileyerek annelik davranışında bireysel farklılıklara yol açmaktadır. Bu faktörlerin bilinmesi ve bakım-yönetim yönetim uygulamalarının bunlara uygun şekilde yürütülmesi, daha iyi annelik davranışlarının sergilenmesinin sağlanmasını mümkün kılacaktır. Bu nedenle anne davranışı sergilemeye dayalı seleksiyon stratejileri hem koyun hem de kuzu refahını ve hayvan verimliliğini artırarak çiftliğin sürdürülebilirliğini sağlayacaktır.

Anahtar kelimeler: annelik davranışları, yenidoğan yaşama gücü, koyun, kuzu

EFFECTS OF MATERNAL BEHAVIOURS ON LAMB' SURVIVAL

Abstract

Lamb survival is essentially based on the successful establishment of a bond between mother and lamb. Nearly half of the deaths observed at pre-weaning period occur at the time of birth or at the age of one week. Lamb death rate has an evident effect on the economic survival of a farm. For this reason, the ewe-lamb interaction taking place at this sensitive period starting immediately after birth and continuing about 24 hours has a very important effect on the enhancement of lamb survival and welfare. At this period, during which newborn lambs are the most vulnerable and lamb losses are the most common, the appropriate and timely exhibition of maternal behavior in ewes plays a critical role in the enhancement of lamb survival and in the achievement of a successful breeding. Animals with a high maternal ability promote the survival of their off-springs by providing their off-springs with the opportunities of feeding, thermoregulation, both immunological and physical protection, comfort and social learning. In addition to this, some factors such as the mother's age, her feeding and psychological status during pregnancy, birth type, difficulty at birth, maternal experience, predisposition and genotype lead to individual differences by affecting maternal ability. Being aware



INTERNATIONAL ASIAN CONGRESS ON CONTEMPORARY SCIENCES – VII

of these factors and the execution of caring-management practices in accordance with these will make it possible to elicit the exhibition of better maternal behaviors. For this reason, selection strategies based on the exhibition of maternal behavior will achieve the sustainability of a farm by increasing both the welfare of ewe and lamb and animal productivity.

Keywords: maternal behaviour, neonatal survival, ewe, lamb



**DISEASE-LIKE SYMPTOMS OF SEEDLINGS OF *PHASEOLUS VULGARIS* L.
GENOTYPES UNDER SALT STRESS OF SURFACELY NON-STERILIZED SEEDS**

Aysun CAVUSOGLU
Yusuf GÜVENALTIN
Onur ÖKSÜZ
Nedret EROL
Evren ATMACA

Kocaeli University, Faculty of Agriculture, Department of Plant Protection, 41285 Kocaeli, Türkiye
Kocaeli University, Institute of Natural and Applied Sciences, Department of Horticultural Sciences, 41001 Kocaeli, Türkiye
Kocaeli University, Institute of Natural and Applied Sciences, Department of Physics, 41001 Kocaeli, Türkiye
Ministry of Agriculture and Forestry, Transitional Zone Agricultural Research Institute, 26005 Eskişehir, Türkiye

Abstract

Worldwide the effect of salinity on agricultural area at plant growth steps are increasingly becoming problematic as the other abiotic factors. The effect of salinity is a complex subject which consisted with limiting water uptake and absorption nutrient. Seed-born pathogens and salt stress are the major biotic and abiotic factors strikingly affected to dry bean genotypes (*Phaseolus vulgaris* L.). At the same time lots of abiotic occasions can be caused to damping off beside salt stress and living pathogens. In the study used four genotypes (Genotype-1, 2, 3 and 4) were surfacely non-sterilized and salt stresses as NaCl were applied as irrigation water at doses of 0 mM, 20 mM, 40 mM, 80 mM and 160 mM. The two factorial (genotypes and salt concentrations) experiments were arranged in a complete randomized design with three replicates and analysis of variance of collected data was done. According to the results in some genotypes, unsuccessfulness of turn seed to seedling was observed after 40 mM salt stress while in some genotypes it was observed just after 20 mM. At the same time healthily seedling capacity rate at 0 mM salt concentration (Control) changed between 12,5-33,3% and at 160 mM salt concentration changed between 0,0-4,2% among genotypes. These results also showed that the importance of seed sterilization or pesticide application to seeds in bean genotypes.

Keywords: Salt stress, seed health, damping off, disease-like, symptoms, seedling, abiotic stress, pulse crops

INTRODUCTION

Phaseolus vulgaris L. is one of the world's most important legume crop plant, which feeds a large number of people worldwide as protein source. The plant largely cultivated nearly in all countries in all over the world (FAOSTAT, 2022). At the same time the most important legume plays an important role in agricultural sustainability via being a part of complex cropping systems (Uebersax et al., 2022). The genus is exposed to many diseases, pests and weeds at different species and at different degree from country to country (Sendi et al., 2020; Beiermann et al., 2022; Etana, 2022; EPPO, 2022), even from field to field. At the same time some abiotic factors as climatic and edaphic threaten the growth and yield of the plant (Graham and Ranalli, 1997). Many crops are not very



tolerant to salinity stress. Hence it is important to find methods, techniques which can lead alleviation of the stress (Miransari and Smith, 2019). Two of the methods are breeding tolerant genotypes and adapted the genotypes to the condition. At the same time *Phaseolus vulgaris* L. naturally has seedborn pathogens (Yesuf and Sangchote, 2005; Marcenaro and Valkonen, 2016; Jadon et al., 2020; Vitti et al., 2021). Abiotic factors have a significant impact on disease severity. The aim of the study was to obtain some knowledge about salt concentration effects on disease-like symptoms of seedling from surfacely non-sterilized seeds in *Phaseolus vulgaris* L. genotypes.

MATERIALS AND METHODS

The study was conducted under Kocaeli University, Agricultural Faculty, in October-2022. The dry bean genotypes obtained from a respective plant crop institue from Türkiye. The bean genotypes approximately harvested fourteen months before the study and seed lots were kept in paper bags along storage at room temperature. The measured characteristics of the sown seeds (namely Genotype-1, 2, 3 and 4) (Figure 1a) of *Phaseolus vulgaris* L. were shown in Table 1 which obtained from measurement of 100 seeds a day before applications. The seeds were placed in plastic trays with thirtytwo cells and each cell consisted aproximately 70 g first-use peat.

The seeds were sown to each cell one by one (Figure 1b) 2,5 cm deep and irrigated with salinized (NaCl) tap water at concentration of 0 mM, 20 mM, 40 mM, 80 mM and 160 mM weekly with 40 ml to each seed as finally prepared water along three weeks. The trays were placed under artificial light with 12 hours/12 hours dark/light condition at controlled site at temperaure $23\pm 2^{\circ}\text{C}$. At the end of the study each seed had 120 ml NaCl concentrated water or non-saline water in control. The sown seeds were treated with no pesticides or no chemicals before or after the sowing. After the three weeks of the seed sowing (Figure 2), seedling growth completed and disease-like symptoms were observed and if a plant were not emergence to surface or not capable to show cotylodons, or not capable true leaves healthily, the seedling were assumed diseased whatever the reason. Only seedling with healthy first true two leaves without any of the degeneration were assumed as non-disease (Figure 3).

This study was carried out in a Completely Randomized Design (CRD) with a total of 20 treatments (5 salinity x 4 genotypes) each comprising of three replicates. Each replicates consisted with 8 seeds that placed in seedling hole and totally 480 seeds were used and calculated. The recorded data were analyzed through statistical software (SPSS Statistics 16.0). A two-way analysis of variance (ANOVA) was used to test for differences among salt treatments and genotypes, as well as interaction between these variables. Multiple comparison were made using Duncan's Multiple Range Test at least $P\leq 0,05$ degree. Results were shown as mean values and standard deviation (\pm) in the table 2.

Table 1. Characteristics of the sown seeds of *Phaseolus vulgaris* L. genotypes

Genotypes	Seed weight (g/1000 seeds)	Mean seed length (mm/seed)	Mean seed width at wide side (mm/seed)	Mean seed width at narrow side (mm/seed)	Seed Color
Genotype-1	305,1	11,99	7,55	4,83	White
Genotype-2	436,4	13,33	8,10	5,76	White
Genotype-3	177,3	8,79	5,40	4,67	White
Genotype-4	488,7	15,10	7,40	5,98	White

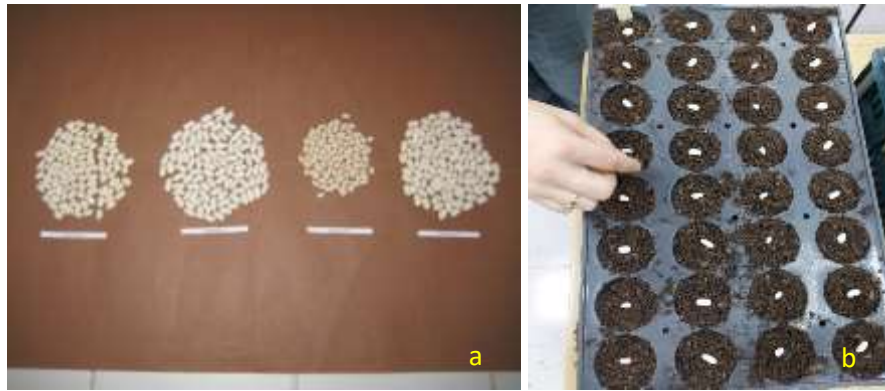

Figure 1. *Phaseolus vulgaris* L. a) Samples of the used seeds of the genotypes, b) Seed placing just before sowing

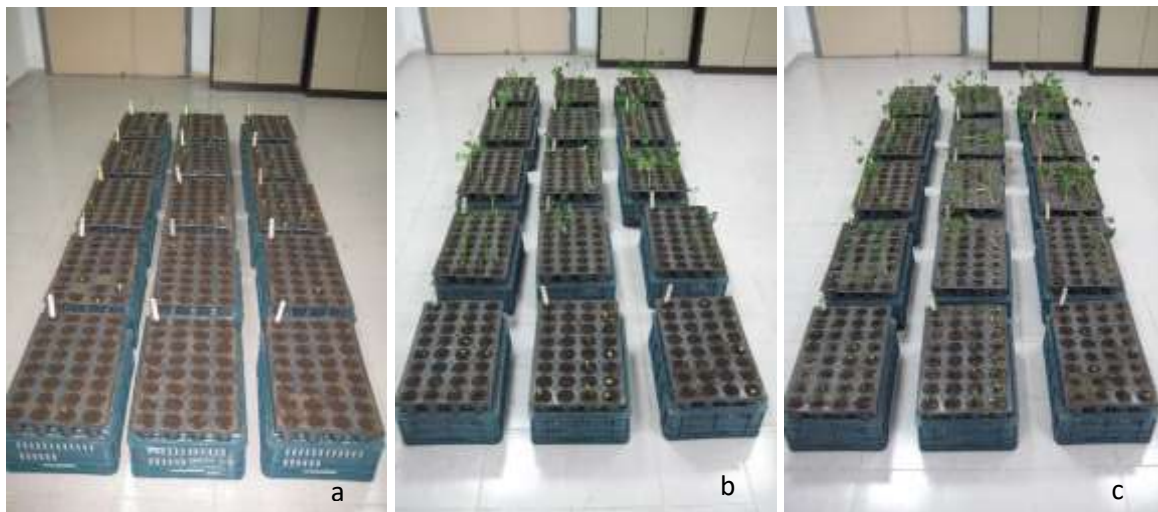

Figure 2. *Phaseolus vulgaris* L. seed emergence and seedling growth from surfacely non-sterilized seeds under salt treatment; a) End of the 1st week, b) End of the 2nd week and c) End of the 3rd week (in all photograph from 0 mM to 160 mM from top three to bottom three)



Figure 3. *Phaseolus vulgaris* L. seedlings 3 weeks after sowing; from left to right ;1st healthy seedling with true two leaves, 2nd with cotyledons but necrotic and degenerated shoot tip, 3rd non-grown seedling with necrotic cotyledons, 4th germinated in media but not emerged cotyledons with rot roots, 5th rot seed in media



RESULTS AND DISCUSSION

All seeds and seedlings were inspected carefully even by digging the growth substrate. According to the data, higher salt stress concentrations were negatively effected on healthy seedling growth in mean of genotypes. After the concentration of 80 mM, there were a sharply decreasing in seedlings health and seedlings showed degeneration or rot as damping off disease like symptoms (Table 2; Figure 4)

Although microorganism analysis was not performed, according to our experience, it was in the form of pathogen contamination according to the visible symptoms. Necrosis, discolorations and degenerations were observed on the cotyledons, hypocotyls or shoots. Similarly browning, rotting and corruption were observed in the root or seeds. Some of them had fungal mycelial growth and a stinker smell like bacterial contamination. Depending on the data in control seedlings which were irrigated with 0 mM salt-water, healthy seedling rate varied between 12,5-33.3% while seedlings which were irrigated with 160 mM salt-water, healthy seedling rate varied between 0,0-4,2% among genotypes.

Table 2. Salt concentrations effects on disease-like symptoms rates of surfacely non-sterilized seeds of *Phaseolus vulgaris* L.

NaCl Cons.	<i>Phaseolus vulgaris</i> L. genotypes				
	Genotype-1	Genotype-2	Genotype-3	Genotype-4	Mean
0 mM	70,8*	70,8*	66,7*	87,50*	73,95±15,50 c**
20 mM	66,7	83,3	75,0	83,3	77,08±13,06 c
40 mM	83,3	79,2	83,3	79,2	81,25±13,59 bc
80 mM	91,7	91,7	79,2	87,5	87,53±13,06 b
160 mM	95,8	100,0	100,0	100,0	98,95±3,61 a
Mean	81,66±16,28***	85,00±15,01	80,84±15,57	87,50±14,02	83,75±15,21

*Data for each cultivar among salt concentration not significant at $p \leq 0.05$ level, **Data with different small letters in the column indicate significantly differences in salt concentration for the mean of cultivars at $p \leq 0.05$ level, ***Data for the mean of genotypes in the line not significant at $p \leq 0.05$ level.

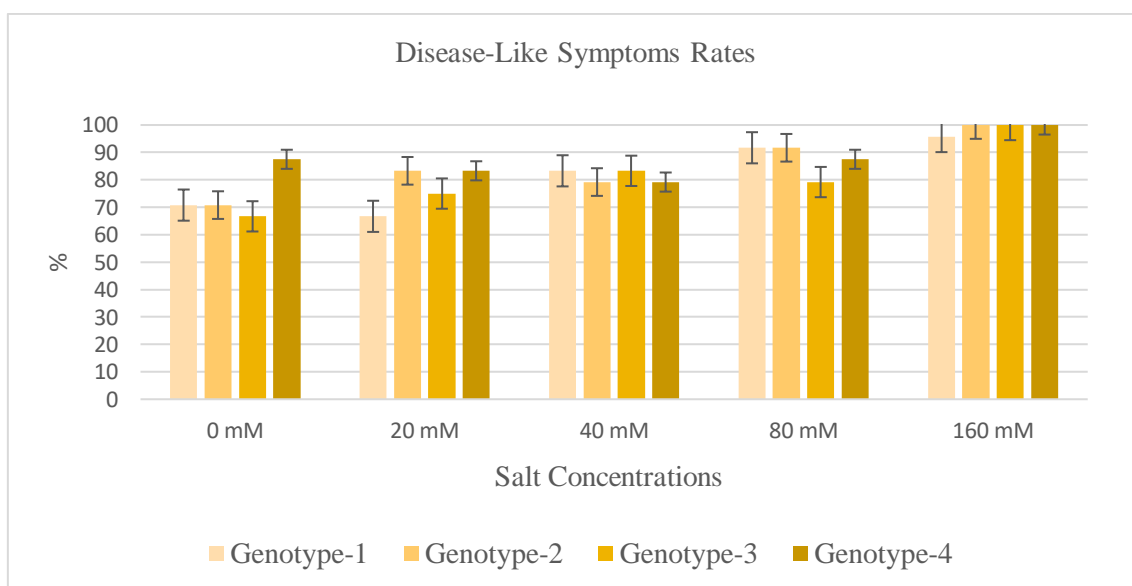

Figure 4. Salt concentration effects on disease-like symptoms rate of *Phaseolus vulgaris* L. genotypes



The findings were in parallel in the study (Marcenaro and Valkonen, 2016) in which the researchers found that the emergence of bean seedlings was low (24-38%) regardless of the source storehouse as their study topics at 15th day after planting. In addition, according to the study, 9-48% of the emerged seedling displayed diseases-like symptoms. At the same time Vitti et al., (2021) isolated the major seed-born fungal and bacterial pathogen from *Phaseolus vulgaris* L. ecotypes from different growing environments and they emphasized that the pathogens are in relation with environmental factors.

Similarly Yesuf and Sangchote (2005) studied with 245 *Phaseolus vulgaris* L. genotypes in Ethiopia and obtained the incidence of different seedborne fungi ranging between 0.2 to 14.5%. They emphasized that the data vary from location to location and growing conditions. There are also some studies about salt effects on seedborne pathogens on pulse crops. The study on *Vicia faba* L. (Haddoudi et al., 2021) showed that salt and drought stress on some of inoculated seedborn pathogen had positive effect on mycelial growth. In our study until 80 mM salt concentration there were not remarkable decreasing in genotypes mean. In addition, there were numerically decreasing in showing disease-like symptoms at 20 mM or 40 mM NaCl application than control plants in the used two genotypes.

But in a general assesment salt stress have negative effects on most of plant growth factors after certain doses in Leguminous plants. In a study (Kul et al., 2020) five local and one commercial types were used and it was determined that the increasing in salt concentrations significantly decreased the germination percentage of the local bean genotypes collected from the Erzurum region. In addition, it was determined that the local genotypes were more tolerant than the selected commercial cultivar in the study. Yousef et al. (2020) studied on effects of salt stress on the growth traits of chickpea (*Cicer arietinum* L.) and pea (*Pisum sativum* L.) seedlings. The findings of their study proved that both varieties chickpea and pea showed variable behavior under salt stress conditions while the pea genotype showed more tolerant against different salt treatments. In the mentioned study, some salt concentration on major growth parameters were in decreasing than control as length of leaf, shoot and root in addition fresh and dry weight of seedlings.

CONCLUSION

The study indicated that according to visually expertise, *Phaseolus vulgaris* L. genotypes potentially may have seedborne pathogens. At the first stage, these should be determined and if these are revealed, studies should be carried out on the importance of seed surface sterilization methods or pesticide application before sowing. The study indicated that the salt stress also were found negatively effective especially at high doses to obtain healthily seedlings regardless of genotypes differences. At the second stage studies on breeding about salt-tolerant cultivars or salt stress amelioration studies can be carried out.

REFERENCES

- Beiermann CW, Miranda JWA, Creech CF, Knezevic SZ, Jhala AJ, Harveson R, Lawrence NC 2022. Critical timing of weed removal in dry bean as influenced by the use of preemergence herbicides. *Weed Technology*, 36: 168-176.
- Etana D 2022. Major insect pests and diseases in common bean (*Phaseolus vulgaris* L.) production in Ethiopia. *Frontiers*, 2(2): 79-87.
- EPPO, 2022. EPPO Global Database. Available at: <https://gd.eppo.int/taxon/PHSVX/pests> [28.10.2022]
- FAOSTAT, 2022. Food and Agricultural Organization of The United Nations Statistics database. Available at: <https://www.fao.org/faostat/en/#home> [28.10.2022]
- Graham PH, Ranalli P 1997. Common bean (*Phaseolus vulgaris* L.). *Field Crops Research*, 53(1-3): 131-146.



- Haddoudi I, Mhadhbi H, Gargouri M, Barhoumi F, Romdhane SB, Mrabet M 2021. Occurrence of fungal diseases in faba bean (*Vicia faba* L.) under salt and drought stress. *European Journal of Plant Pathology*. 159(2): 385-398.
- Jadon KS, Thirumalaisamy PP, Kumar R 2020. Major seed-borne diseases in important pulses: Symptomatology, aetiology and economic importance. In: Kumar R, Gupta A (eds), *Seed-Borne Diseases of Agricultural Crops: Detection, Diagnosis and Management*. Singapore: Springer, pp. 469-542.
- Kul R, Ekinci M, Parlakova-Karagöz F, Dursun A, Açar G, Yıldırım E 2020. Effect of salt stress on germination in some snap bean (*Phaseolus vulgaris* L.) genotypes collected from Erzurum region. *Erciyes Tarım ve Hayvan Bilimleri Dergisi*, 3(2): 6-11.
- Marcenaro D, Valkonen JP 2016. Seedborne pathogenic fungi in common bean (*Phaseolus vulgaris* cv. INTA Rojo) in Nicaragua. *PLoS One*, 11(12): e0168662.
- Miransari M, Smith D 2019. Sustainable wheat (*Triticum aestivum* L.) production in saline fields: a review. *Critical Reviews in Biotechnology*, 39(8): 999-1014.
- Sendi Y, Pfeiffer T, Koch E, Mhadhbi H, Mrabet M (2020). Potential of common bean (*Phaseolus vulgaris* L.) root microbiome in the biocontrol of root rot disease and traits of performance. *Journal of Plant Diseases and Protection*, 127(4): 453-462.
- Uebersax MA, Cichy KA, Gomez FE, Porch TG, Heitholt J, Osorno JM., Kamfwa K, Snapp SS, Bales S 2022. Dry beans (*Phaseolus vulgaris* L.) as a vital component of sustainable agriculture and food security-A review. *Legume Science*, e155.
- Vitti A, Bevilacqua V, Logozzo G, Marzario S, Gioia T, Nuzzaci M 2021. Response of two local common bean ecotypes of “Fagioli di Sarconi” PGI (*Phaseolus vulgaris* L.) to seed-borne pathogens and environmental change. *Agronomy*, 11(10): 1924.
- Yesuf M, Sangchote S 2005. Occurrence and distribution of major seedborne fungi associated with *Phaseolus* bean seeds in Ethiopia. *Kasetsart Journal (Nat. Sci.)*, 39(2): 216-225.
- Yousef F, Shafique F, Ali Q, Malik A 2020. Effects of salt stress on the growth traits of chickpea (*Cicer arietinum* L.) and pea (*Pisum sativum* L.) seedlings. *Biological and Clinical Sciences Research Journal*, 29. Available at: doi: <https://doi.org/10.54112/bcsrj.v2020i1.29> [13.11.2022]



JCI AKREDİTASYONLU ÖZEL SAĞLIK KURUMLARINDA YEŞİL (ÇEVRECİ) UYGULAMALARIN İNCELENMESİ

Şeref Maden

Gökhan Kerse

Karamanoğlu Mehmetbey Üniversitesi, Sağlık Hizmetleri Meslek Yüksekokulu, Tıbbi Hizmetler ve Teknikler Bölümü, Karaman, TÜRKİYE

Kafkas Üniversitesi, İktisadi ve İdari Bilimler Fakültesi, Yönetim Bilişim Sistemleri Bölümü, Kars, TÜRKİYE

Özet

Bu çalışmanın temel amacı, JCI akreditasyonuna sahip özel sağlık kuruluşlarının web sayfalarını inceleyerek uygulamakta oldukları yeşil (çevreci) uygulamaları belirlemektir. Bu “kapsamda” akredite olmuş kurumlarda yeşil uygulamaların olup olmadığı ve (var ise) hangi yeşil uygulamaların bulunduğu” tespit edilmeye çalışılmıştır. Araştırmaya dahil olan JCI akreditasyonu bulunan 33 özel hastane ve yan dalları, durum çalışması deseninde incelemeye alınmıştır. Verilerin toplanmasında sağlık kuruluşlarının kurumsal web sayfalarında yer alan bilgiler süzölmüş ve tablo haline getirilerek içerik analizi yapılmıştır. Veri setleri MAXQDA 2020 programından yararlanılarak irdelenmiş, bulgulara ait kod bulutu, yaratıcı kodlama ve kelime bulutu modellemeleri yapılarak yeşil uygulamalara dair çıkarımlar yapılmıştır. Çalışma sonucunda JCI akreditasyonu bulunan sağlık kurumlarının yeşil politikaları ile ilgili olarak genellikle atık yönetimi, çevre sorumluluğu ve kaynağında ayrıştırma kavramlarının öne çıktığı, birçok sağlık kurumunun çevresel farkındalığa sahip olduğu ve kurumsal politikalarında da çevreyi korumaya dair beyanlara yer verdiği görülmüştür. Çalışma kapsamındaki kurumlarda uygulanan çevreci politikaların sürdürülebilirlik temelinde değerlendirildiği ve politikalarının da bu doğrultuda şekillendiği söylenebilir. JCI akreditasyonuna sahip kuruluşlarda sürdürülebilirlikle beraber kurumların alternatif enerji kaynaklarına ve su kullanımında tasarruflu uygulamalara yönelimi sağlayacak yeşil politikalara yer verilmesi önerilebilir.

Anahtar Kelimeler: Çevre, Atık yönetimi, Enerji verimliliği, Yeşil politika, Sağlık kurumları

INVESTIGATION OF GREEN (ENVIRONMENTAL) PRACTICES IN PRIVATE HEALTH INSTITUTIONS WITH JCI ACCREDITATION

Abstract

The primary goal of this research is to identify green (environmental) practices implemented by examining the web pages of private health institutions with JCI accreditation. Within this scope, it has been attempted to determine whether accredited institutions have green practices and, if so, which green practices are present. 33 private hospitals and their sub-branches with JCI accreditation included in the study were examined in a case study design. The information on the institutional web pages of health institutions was filtered and tabled, and content analysis was performed during data



collection. The MAXQDA 2020 program was used to examine the data sets, and inferences about green practices were made by creating code cloud, creative coding, and word cloud models of the findings. The study has revealed that waste management, environmental responsibility, and source separation are generally prominent in relation to the green policies of health institutions with JCI accreditation. It has also revealed that many health institutions have an awareness of the environment and incorporate statements on environmental protection into their corporate policies. On the basis of sustainability, it can be said that the included institutions evaluate and shape their environmental policies in accordance with this principle. It could be advised that JCI-accredited institutions also include green policies that will allow them to use alternative energy sources and water-efficient practices in addition to sustainability.

Keywords: Environment, Waste management, Energy efficiency, Green policy, Health institutions.

1. GİRİŞ

Günümüzde ülkelerin kalkınma hedefleri arasında sağlıkla ilgili değişim politikaları dikkat çekmektedir (Sachs vd., 2019). Genel bir ifadeyle sağlığın geliştirilmesi ve yükseltilmesi, değişen çevre şartlarına uyum sağlamaya çalışan ülkelerin kalkınmasında öncelikli bir yere sahiptir. Çünkü sağlığın geliştirilmesi süreci yalnızca hastalar ve sağlık personelinin etkileşimiyle kısıtlı olmayan, çevrenin geliştirilmesi ile doğrudan ilintili olan proaktif bir süreçtir (Kickbusch, 2019, Zhang vd., 2019). Son yıllarda sağlık kurumlarının geleneksel yapısından ayrılarak tasarım, stres ve kaygıyı azaltma, hasta memnuniyetini artırma, sağlığı ve iyileşmeyi teşvik etme amacıyla estetik iyileştirmeleri önceleme gibi temel konulara yöneldiği söylenebilir (Schweitzer vd., 2004). İnsanların değişen ve gelişen dünya perspektifinden yola çıkarak sağlıkla ilgili beklentilerini ifade etmesi, sağlık kurumlarının sürekli gelişimini, çevre ile uyumlu ve sürdürülebilir olmasını mümkün kılar.

Sürdürülebilir sağlık hizmetinin temelinde çevre ile bütünleşerek toplumsal beklentilerin ve ihtiyaçların karşılanması yer almaktadır (Faggini vd., 2018). Farkındalığı yüksek olan insanların sayısının artması ve hizmet tercihlerinde seçici davranışları sürdürülebilirlik kavramına etki etmiş, özellikle sağlık sektöründe hasta memnuniyetini artırıcı çalışmalar yapmaya ve sağlık hizmetlerinin kalitesinin artırılması için sağlık kuruluşlarının ve yan dallarının akreditasyon programları yürütmesine teşvik etmiştir (Alkhenizan & Shaw, 2011). Çünkü akreditasyon, sağlık hizmetlerine özgü standartların sürekli iyileştirilmesini ve bu sayede tercih edilebilirlik düzeylerinde gözle görülebilir bir artış potansiyelini barındırmaktadır (Campra vd., 2021). Dolayısıyla çevre ile ilgili hassasiyetin kurumsal politika haline gelmesi, sağlık kurumlarına nitelikli bir imaj kazandırarak sürekliliğine katkı sağlayacak bir etken olarak algılanabilecektir.

Hastanelerin kurumsal web siteleri, şeffaflığı artırmak, kurumsal sosyal sorumluluk (KSS) uygulamalarını öne çıkarmak ve rakiplerine göre mevcut konumlarını geliştirmek için aktif olarak kullanılmaktadır (Creixans-Tenas vd., 2019). Yeşile ulaşma hedefleri hem kalitenin gereği hem de kurumsallaşmanın gereği olarak görülmektedir (Candan Dönmez vd., 2019). Güncel bir konu olan çevre özelinde yapılması ve yeşil uygulamaların bilinçli bir şekilde uygulandığı sağlık kurumlarında ele alınması açısından önemlidir. Literatürde sağlık kurumlarında uygulanan çevreci yaklaşımların az sayıda çalışıldığı görülmektedir. Bu nedenle bu çalışmada sağlık hizmetlerinin sunumunda ayrıcalıklı bir yere sahip olan ve dünya standartlarında hizmet sunumu gerçekleştirdiğini JCI akreditasyonu ile belgeleyen sağlık kuruluşlarının yeşil uygulamaları, yeşil uygulamaların kurumlarda politika haline gelip gelmediği ve hangi yeşil uygulamanın daha çok tercih edildiği incelenecektir.



2. KAVRAMSAL ÇERÇEVE

Yaşadığımız gezegenin korunması enerji kaynaklarının bilinçli kullanımı, çevrenin kirletilmemesi ve yaşam alanlarının çevreyle uyumlu olmasına bağlıdır. Dünya üzerinde kıt kaynakların hızla tüketimi söz konusudur ve sağlık sektörü enerji ve su kaynakları başta olmak üzere çevreye etki eden kurumların başında yer almaktadır (Kılıç & Güdük, 2018). Çevrenin korunması ve sağlığın yükseltilmesi sürecinde sağlık kurumlarının yapısal olarak işlevi çok değerlidir (Sahamir vd., 2019). Yeşil uygulamalar olarak tanımlanan çevreyi ve çevrenin etkilediği insanı koruma misyonuyla birçok uygulama sağlık kuruluşlarında dikkatle uygulanmaktadır.

2.1. Sağlıkta Yeşil Uygulamalar, Sürdürülebilirlik ve Politikalar

Sağlık kurumlarının ve kuruluşlarının temel görevi her ne kadar hastalıkların tedavi edilmesi şeklinde bilinse de asıl gayesi hastalıklara zemin hazırlayan sebeplerin ortadan kaldırılması sürecinde aktif rol almasıdır. Bir diğer ifadeyle insan sağlığının bozulmasında tehdit unsuru haline gelebilecek çevre sorunlarının önlenmesinde rol almasıdır (Ekerkil & Savaş, 2019). Hastaneler ve diğer sağlık tesislerinde çevrenin kişi üzerindeki etkisi, şifa ve iyileşme yeri yaratma niyetinden dolayı diğer tüm alanlardan daha da ayrıcalıklı olmasını sağlar (Wood vd., 2016). Çevre dostu hastaneler, enerji tasarrufunun öncelikli olduğu, ekolojik ayak izine dikkat edilen ve karbon salınımının olabildiğince azaltıldığı, verimlilik ve kalitenin gözle görülür şekilde arttığı bir hastane olarak tanımlanmaktadır (Candan Dönmez vd., 2019).

Sağlığın korunması ve mevcut durumun daha da geliştirilmesinden sorumlu otoriteler, "Yeşil ve Sağlıklı Hastaneler" tanımını ele alırken çevre üzerindeki etkiyi sürekli olarak azaltabilme yetisine sahip ve halkın sağlık ihtiyacına genel olarak yanıt verebilen ve iyileştirmeyi kolaylaştıran sağlık kuruluşları olarak tanımlamışlardır. Çünkü insan sağlığı ile çevre arasında birbirini tamamlayan ve birbirlerine bağımlı olan bu ilişkinin varlığı, gerçekleştirilecek tüm politika ve uygulamalara etkin yön tayin edecektir. Çevre ile ilgili olarak izlenecek politikalara hastanelerin yeşil liderlik uygulamaları, kimyasal maddelerin efektif yönetimi, evsel ve tıbbi atık yönetimi, enerji verimliliği, su tasarrufunun sağlanması, ilaç kontrolü, yeşil bina ve tedarik yönetimi gibi konuların dahil edilerek misyonlarında bu uygulamalara yer verilmesi gerekliliği savunulmaktadır (Shih vd., 2017). Ayrıca biyoiklimsel ve çevreye duyarlı sağlık tesislerinin inşa edilmesi, doğal havalandırma yöntemlerinin sağlık tesislerine entegre edilmesi, gün ışığından aktif olarak yararlanma ve güneş kontrolü ile hastanelerin enerji tüketimi ve karbon salınımında büyük ölçüde azalma sağlanacaktır (Liu vd., 2018).

Sürdürülebilir inovatif uygulamalar çevre bilincinin ve kalitenin gerekliliği olarak görülse de, hızla gelişen endüstrileşme, tıp alanındaki teknolojik değişimler ile kıt kaynakların etkin kullanılma zorunluluğu, inovatif uygulamaları yeşil ile ayrılmaz bir bütün olarak ele almamızı zorunlu kılmıştır (Karaca vd., 2018). Çünkü gelecek nesillere yalnızca teknolojik yenilikler değil aynı zamanda yaşanılabilir bir çevre ve kaynakları korunmuş bir dünya bırakma zorunluluğumuz bulunmaktadır. Sağlık sektörünün çevre politikalarında bu denli önemsenmesi, sağlığın kapsayıcı, güvenli, dayanıklı ve sürdürülebilir şehirleri hedefleyen sürdürülebilir kalkınma hedefinde bir ön koşul olarak da yer almasını sağlamıştır (Ramirez-Rubio vd., 2019).

Çevresel sürdürülebilirlik algısı ve farkındalığı artan ve dolayısıyla bilinçlenen örgütlerin ekolojik misyonlarını başarıyla gerçekleştirebilmeleri, çalışanların yeşil çalışan davranışı sergilemesiyle mümkün hale gelebilecektir (Ones & Dilchert, 2012). Kurumların çalışanlarına ve çevrelerine gösterdiği özen sayesinde motivasyon artacak ve yine kurumların politikası haline gelen bu davranışlar sayesinde sürdürülebilirliğe katkı sağlanacaktır. Kalite ve dolayısıyla JCI akreditasyonu



çalışmalarını yürüten sağlık kuruluşları da doğrudan ve dolaylı olarak kendilerinden hizmet alacak hastaları ve sağlık hizmeti sunacak çalışanlarını bu sayede tatmin etmiş olacaklardır.

2.2. Sağlıkta JCI Akreditasyonu

Akreditasyon, kendini kaliteli olarak ifade eden kuruluşların, önceden belirlenmiş birtakım standartlara uygunluğunun bağımsız kuruluşlar aracılığı ile denetlenmesini ve ortaya koyduğu politikaların standartlar ölçütünde olup olmadığını ifade eder. Akredite sağlık kuruluşları yönetim, çalışan ve hasta güvenliği konusunda tüm dünyada kabul gören bir kimlik kazanmış olur (Kavak, 2018).

Sağlık kurumlarında kalite kavramının olgunlaşması sağlık personeli, destek hizmetleri ve idari hizmetler bağlamında değerlendirilir. Sağlık personelinin kalitesinin hasta memnuniyeti için değerli olduğu, itici (maliyet, sigorta ve bekleme süresi) ve çekici (bekleme olmaması, satın alınabilirlik, JCI sağlık hizmeti kalitesi, egzotik destinasyon vb.) faktörler olarak belirtilen nedenlerden dolayı sağlık kurumlarının tercih edildiği belirtilmekte ve bu süreçte öncü faktörün kurumların kalitesi olduğu ifade edilmektedir (Collins vd., 2019).

Diğer taraftan JCI akreditasyon belgeli sağlık işletmelerinin çevreye duyarlı politikaları desteklediği, kurumların yalnızca hastalara güvenle müdahalesinden öte, sağlığa etki edebilecek çok yönlü uygulamaları da ele aldığı (etki, bakım, çevre, maliyet), objektif sistemler kurarak sağlık sektörünün dönüştürülmesi konusunda öncü olduğu görülmektedir (Al Kuwaiti & Al Muhanna, 2019; Yali & Zheng, 2020). Sağlık sektöründe yeşil politikaların hayata geçirilmesinin ve bunun örgüt kültürü halini almasının, JCI akreditasyonunu tamamlamış kurumların lokomotif görevi görmesi ile ivme kazanabileceğini söylemek mümkündür. Bu sayede toplumun yeşil ile özdeşleşmiş uygulamaları özümseyerek diğer alanlarda da bu olguyu talep etmesi olağanlaşacaktır.

3. ARAŞTIRMA YÖNTEMİ

Araştırma durum çalışması deseninde yürütülmüştür. Araştırmanın amacı doğrultusunda “JCI akreditasyonuna sahip özel kuruluşların yeşil uygulamaları var mıdır? Sahip olunan yeşil uygulamalar nelerdir?” araştırma soruları oluşturulmuştur. Çalışmanın evrenini ülkemizde JCI akreditasyonuna sahip özel sağlık kuruluşları oluşturmaktadır. Çalışma kapsamında ülkemizde yer alan 33 özel sağlık kuruluşunun tamamının web sayfası yeşil uygulamalar yönüyle incelenmiş ve içerik analizi yapılarak betimlenmiştir. MAXQDA 2020 programından yararlanılarak veri setlerinden temalar ve örüntüler elde edilmiş, bulgulara ait kod bulutu, yaratıcı kodlama, kelime bulutu ve tek-vaka modellemesi yapılarak yeşil uygulamalara yönelik çıkarımlar yapılmıştır.

4. BULGULAR

Çalışmamızda 2022 yılına ait JCI akreditasyonu devam eden 33 sağlık kurum ve kuruluşunun yeşil uygulamalar ile ilgili sahip oldukları belge ve bu belgelerin kazanımı olan kurumsal politikalar yer almaktadır. Öncelikle çevreci uygulamaları doğrudan ya da dolaylı olarak niteleyen belgelere sahip kuruluşların dağılımı Tablo 1’de verilmiş ve ardından veri setleri ile modellenen kodlamalar sırası ile irdelenmiştir.



Tablo 1. JCI Belgeli Sağlık İşletmelerinin Sahip Olduğu Ödül ve Sertifikaların Dağılımı

Ödül ve Sertifika İsmi	Sayı	Yüzde
LEED-BREEAM- GREEN STAR	3	8.55
ISO 9001 Kalite Yönetim Sistemi Sertifikasyonu	2	5.70
HIMSS (Healthcare Information and Management Systems Society)	1	2.85
TÜRKAK ISO 15189	1	2.85
TUV Hessen Green Building "Yeşil Hastane Binası"	1	2.85
ISO 14001:2015 Çevre Yönetim Sistemi	2	5.70

Tablo 1’de ülkemizdeki JCI akreditasyonu bulunan sağlık kurum ve kuruluşlarının dünyanın önde gelen yeşil bina derecelendirme kuruluşları olan LEED, BREEAM ve GREEN STAR’ı tercih ettikleri görülmüştür (Shan & Hwang, 2018). Bu belgelendirme kuruluşları binaların yapım aşamalarından başlayarak çevreye etki eden birçok parametreyi ölçmektedirler (Karaca vd., 2018).

33 kurum içerisinde 12 (%36) kurumun çevre politikalarına web sayfalarında yer vermediği, 21 (%64) kurumun ise politikalarında çevre ile ilgili bilgilere yer verdiği görülmüştür. 24 (%73) kurumun hastane genelini kapsayan JCI akreditasyonu bulunurken, 4 (%12) kurumun poliklinik (ayaktan hasta bakımı) hizmetleri, 4 (%12) akademik tıp merkezi hastane programı ve 1 (%3) laboratuvar olmak üzere toplam 33 kurum ve kuruluşun akredite olduğu belirlenmiştir.

33 JCI akredite kuruluştan 21 (%64) tanesinin ağırlık olarak üzerinde durduğu konuların başında çevrenin korunması ve çevre ile ilgili uygulamaların öncelenmesi gelmektedir. Ana temalar genel olarak koruma, atık azaltma ve çevreci uygulamalara teşvik eden kurumsal sorumluluk şeklinde sıralanmıştır. Alt temalar kurumların ortaya koyduğu vizyon ve misyon ile ilgili olarak farklılık göstermekte olup, sahip olunan sertifika ve belgelerin de çevre politikalarına katkısı son derece belirleyici olmuştur. Birkaç örnek ile desteklemek gerekirse:

K1 numaralı kuruluş, hastane genelindeki uygulamalar ile akredite olmuş bir kurumdur ve web sayfasında yer alan çevre ile ilgili paylaşımında “*Doğal kaynakların korunması ve enerji tasarrufunun gerçekleştirilmesi, tüm çalışanlarımızın çevre konusunda bilinçlendirilmesi ve eğitilmesi, atıkların azaltılması, kaynağında doğru ayrıştırılması, mevcut atıkların çevreye zararının en aza indirilmesi, oluşan tüm atıkların sadece yetkilendirilmiş firmalara teslim edilmesi, çevreye olan etkilerin minimum düzeyde tutulması, ulusal mevzuat ve uluslararası standartlara göre çevreyi koruma ile ilgili yükümlülüklerin yerine getirilmesidir*” şeklinde paylaşımında bulunarak stratejisini ortaya koymuştur.

K14 ve K18 numaralı kuruluşlar hastane geneli JCI akreditasyonuna sahip olmanın yanı sıra, çevre ile ilgili politikalarına baktığımızda “*JCI ve Sağlık Bakanlığı kalite standartları çerçevesinde, politikalarını; misafirlerine, çalışanlarına, tedarikçilerine, diğer tüm ilgili taraflara duyurmayı, yayınlamayı ve ilgili taraflarda çevre bilincini oluşturmayı, hizmet sunumunun tüm aşamalarında ortaya çıkabilecek atıkları tanımlamayı, kaynağında gerekli önleyici tedbirleri almayı, doğru geri dönüşümü ve bertarafı sağlamayı, misafirlerimize, çalışanlarımıza ve tedarikçilerimize sürekli eğitim vererek çevreye karşı sorumluluk bilincini oluşturmayı, duyarlılıklarını artırmayı, çevresel boyutları belirlemeyi, çevresel etkilerin türlerini ve zararlarını tespit etmek için etkin bir risk yönetim sistemi kurmayı ve sürekli geliştirmeyi, tüm misafirlerimize hijyenik bir hastane ve bakım çevresi sağlamayı taahhüt eder*” beyanları ile deklare etmektedir.

K16 numaralı akademik tıp merkezi hastane programı yürüten kurumdaki politikalarda “*Çevre ile ilgili tüm yerel ve ulusal kanun ve yönetmeliklere uymakla beraber, JCI standardı dahilinde çevre ile ilgili tüm gerekleri yerine getirmektedir. Öncelikli hedef olarak tüm sağlık kuruluşlarında faaliyet sonucu oluşan atıkları tespit edip bu atıkların hasta ve çalışan sağlığını tehdit etmeyecek şekilde*



uzaklaştırılması için her kuruma özgü bir atık yönetim planı oluşturmaktadır. Bu plan doğrultusunda atıkları minimize etmeye çalışıp geri kazanılabilenleri de ayırmaktadır. Geri kazanılamayan atıkları kanun ve yönetmeliklere uygun olarak bertaraf edilmeleri için ilgili kurumlara teslim etmektedir. Çevre sorumluluğunu tüm grupta oluşturmak için tüm çalışanlarını bilinçlendirmekte ve bireysel sorumluluklarına göre eğitimlere tabi tutmaktadır” hedefleri belirlenmiştir.

Çalışmamızda sağlık kurumlarının web adresleri aracılığı ile topluma açıkladıkları politika ve uygulamalar incelenmiş, MAXQDA 2020 nitel araştırma programı kullanılarak modellenmiş ve Şekil 1’de yer alan kelime örüntüsü oluşturulmuştur.



Şekil 1: JCI Akreditasyonu Bulunan Sağlık Kurumlarının Yeşile Dair Kod Bulutu

Şekil 1’de akredite olan sağlık kurumlarının yeşil politikalar ile ilgili olarak genellikle dönüştürme, geri kazanım, zarar azaltma, sürdürülebilirlik, çevreci uygulamalara teşvik, yasal sorumluluklar ve atık yönetimi kavramını öncelikledikleri bu çalışma doğrultusunda görülmüştür.

Çevre bilinci ve yeşil uygulamalara dair yaratıcı kodlamalara Şekil 2’de yer verilmiş, kurumların üzerinde yoğunlaştığı yeşil uygulamalar kategorize edilmiştir.

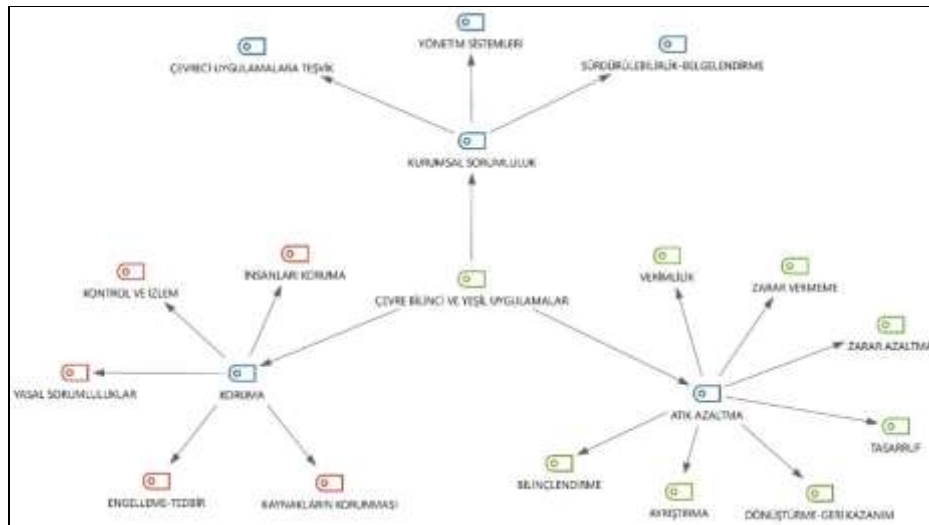

Şekil 2: Yeşil Uygulamaları İçeren Yaratıcı Kodlama



Şekil 2’de yer alan kelime örüntüleri kurumların üzerinde yoğunlaştığı kavramlardır ve koruma, atık azaltma ile kurumsal sorumluluk ekseninde politikalarını yoğunlaştırmışlardır. Atık azaltma kategorisi en çok üzerinde durulan konu olmuş ve bunu koruma kategorisi takip etmiştir. Kurumların sürdürülebilir kalkınmasında politika haline gelen yeşil uygulamalarına ait üzerinde durduğu kelime bulutu Şekil 3’te yer almaktadır.



Şekil 3: Yeşil Uygulamalara Dair Kelime Bulutu

Yeşil uygulamaları genel bir perspektiften izleyebileceğimiz Şekil 3’teki kelime bulutuna baktığımızda: “atık” ve “çevre” merkezinde şekillenen yeşile dair kelimeler ayrıştırma, geri kazanım, bilinçlendirme, sorumluluk, sağlık ve bertaraf etme alt kategorilerine sahiptir. Dönüştürme ve geri kazanımın çok daha fazla önemsendiği bu modelde, bilinçlendirme, zarar azaltma, sürdürülebilirlik, yasal sorumluluk, teşvik, tasarruf gibi kategorilerin kurumlarda ön plana çıktığı söylenebilir.

5. SONUÇ VE ÖNERİLER

Çalışmada JCI akreditasyonu bulunan sağlık kuruluşlarının web sitelerinde yeşile dair uyguladıkları politikalar sürdürülebilirlik, atık yönetimi, çevrenin korunması ve tüm bu süreçleri tek çatı altında bir araya getiren çevre bilinci/politikaları kurumsal kimlik olarak tanımlanmıştır. Küresel ısınma ve iklim değişikliği gerçeğinin etkileri dünya genelinde sürdürülebilirlik kavramlarını ve yeşil çözümleri gündeme getirmiş (Mulimani, 2017), çevrenin korunmasına dair duyarlılık artış göstermiş ve ekolojik ayak izinin azaltılmasına yönelik çözümler için çaba gösterilmeye başlanmıştır (Karademir & Aybars, 2021). Sağlık sektöründe de atık yönetimi, çevre yönetimi, enerji yönetimi boyutları dikkate alınarak sürdürülebilir, ekolojik, doğaya saygılı yeşil binaların hayata geçirilmesi gerekliliği çalışmalarda ifade edilmiştir (Kurtaran & Yeşildağ, 2021; Mansur & Korkmaz, 2020).

Günümüzde birçok firmanın tüketiciler tarafından tercih edilmesi, işletmelerin yeşil yönetim ve uygulamalarına yönelimleri sayesinde olmakta (Çilingir & Erkılıç, 2021), sağlık sektöründe de kurumların rekabet edebilme ve tercih edilmelerinin temel unsuru olarak hastaların beklentilerinin yanında JCI vb. kalite göstergeleri yer almaktadır (Avcıl & Uslu, 2022). Sağlık kurumlarının tercih edilmesinin başlıca sebepleri arasında kapsayıcı, güvenli, dayanıklı ve sürdürülebilir şehirleri hedefleyen sürdürülebilir kalkınma hedeflerinde açıkça sağlık ve esenliğe atıf yapılması yer almaktadır (Ramirez-Rubio vd., 2019). Sürdürülebilir sağlık hizmetinin temelinde de çevre ile bütünleşerek toplumsal beklentilerin ve ihtiyaçların karşılanması yer almaktadır (Faggini vd., 2018).



Çalışmamızda elde edilen bulgulardan yola çıkarak; ülkemizdeki JCI akreditasyonu bulunan sağlık kurum ve kuruluşlarının sürdürülebilir çevreci yapıya bürünmesi kalitenin bir gerekliliği olarak görülmüş ve bu doğrultuda misyonlarını belirlemişlerdir. Yeşil politikalar genellikle literatürde yer alan kategoriler ile uyumlu olmakla birlikte, sosyal sorumluluk uygulamalarında farklılık göze çarpmaktadır. Ağaç dikimi, otoparklarda elektrikli araçlar için özel alanların oluşturulması, atık pil toplama projelerinin desteklenmesi vb. uygulamalar bu farklılıklara örnek verilebilir. Genel olarak tüm kurumların çevre özelinde atıklar ve enerji üzerinde yoğunlaştığı söylenebilir. JCI akreditasyonuna sahip kuruluşlarda sürdürülebilirlikle beraber kurumların alternatif enerji kaynaklarına ve su kullanımında tasarruflu uygulamalara yönelimi sağlayacak yeşil politikalara yer verilmesi önerilebilir.

Çalışmadaki en önemli kısıtlılığın; sağlık kurumlarının web sayfalarında belirttikleri bilgiler ışığında yapılması, gerçekte uygulanmakta olan fakat özel sağlık kuruluşların sitelerinde paylaşımı yapılmayan çevreci uygulamaların belirlenememesi, dolayısıyla göz ardı edilmesi durumudur.

KAYNAKÇA

- Al Kuwaiti, A., & Al Muhanna, F. A. (2019). Challenges facing healthcare leadership in attaining accreditation of teaching hospitals. *Leadership in Health Services*, 32(2), 170–181.
- Alkhenizan, A., & Shaw, C. (2011). Impact of accreditation on the quality of healthcare services: a systematic review of the literature. *Annals of Saudi Medicine*, 31(4), 407–416.
- Avcı, S., & Uslu, K. (2022). JCI Sağlık Standartlarının Akreditasyonunun Türkiye’de Uygulanmasında Üniversite ve Devlet Hastanelerinin Hizmet Kalitesinin İncelenmesi. *Doğuş Üniversitesi Dergisi*, 23(1), 279–297.
- Campra, M., Riva, P., Oricchio, G., & Brescia, V. (2021). Association between Patient Outcomes and Joint Commission International (JCI) Accreditation in Italy: An Observational Study. *Calitatea*, 22(181), 93–100.
- Candan Dönmez, Y., Aslan, A., & Yavuz VAN Giersbergen, M. (2019). Environment-Friendly Practices in Operating Rooms in Turkey. *The Journal of Nursing Research : JNR*, 27(2), e18.
- Çilingir, F., & Erkılıç, E. (2021). Yeşil Yıldızlı Otel İşletmelerinin Yeşil Yönetim ve Uygulamaları Üzerine Bir İnceleme: Muğla Örneği. *Journal of Tourism Intelligence and Smartness*, 4(2), 218–238.
- Collins, A., Medhekar, A., Wong, H. Y., & Cobanoglu, C. (2019). Factors influencing outbound medical travel from the USA. *Tourism Review*, 74(3), 463–469.
- Creixans-Tenas, J., Coenders, G., & Arimany-Serrat, N. (2019). Corporate social responsibility and financial profile of Spanish private hospitals. *Heliyon*, 5(10), 1–9.
- Ekerğil, V., & Savaş, A. B. (2019). Yeşil Hastanelerde Çevre Maliyetleri ve Maliyet Hesaplarının Sınıflandırılması. *Muhasebe ve Finansman Dergisi*, 83, 45–60.
- Faggini, M., Cosimato, S., Nota, F. D., & Nota, G. (2018). Pursuing sustainability for healthcare through digital platforms. *Sustainability*, 11(1), 165.



- Kamarudin, S. F., Mustapha, M., & Kim, J.-K. (2021). Green strategies to printed sensors for healthcare applications. *Polymer Reviews*, 61(1), 116–156.
- Karaca, P. Ö., Atılgan, E., & Zekioğlu, A. (2018). Sağlık Hizmetlerinde Sürdürülebilirlik Bağlamında İnovatif Bir Uygulama: Yeşil Hastaneler. *Ejovoc (Electronic Journal of Vocational Colleges)*, 8(2), 77–87.
- Karademir, A. Ç., & Aybars, D. A. Ğ. (2021). Sürdürülebilirlik Uygulaması Olarak Yeşil Bina ve LEED Sertifikasyonu Üzerine Türkiye’de İnşaat Sektöründe Bir Çalışma. *Akademia Doğa ve İnsan Bilimleri Dergisi*, 7(1), 63–83.
- Kavak, D. G. (2018). Türkiye Sağlık Hizmetleri Kalite ve Akreditasyon Enstitüsü (Tüska) Sağlıkta Akreditasyon Standartları. *Sağlıkta Kalite ve Akreditasyon Dergisi*, 1(1), 14–20.
- Kickbusch, I. (2019). Health promotion 4.0. In *Health Promotion International*, 34(2), 179–181.
- Kılıç, C. H., & Güdük, Ö. (2018). Yeşil hastane kavramı ve türkiye’deki son kullanıcıların beklentileri üzerine bir hastane örneği. *Gümüşhane Üniversitesi Sağlık Bilimleri Dergisi*, 7(1), 164–174.
- Kurtaran, A. T., & Yeşildağ, A. Y. (2021). Trabzon’daki Kamu Hastanelerinin Yeşil Hastane Standartlarına Uygunluklarının Belirlenmesi. *Eskişehir Osmangazi Üniversitesi İktisadi ve İdari Bilimler Dergisi*, 16(3), 777–797.
- Liu, Y., Wang, Z., Zhang, Z., Hong, J., & Lin, B. (2018). Investigation on the Indoor Environment Quality of health care facilities in China. *Building and Environment*, 141, 273–287.
- Mansur, F., & Korkmaz, S. (2020). Sağlık hizmeti kullanıcılarının yeşil hastane farkındalık düzeylerini belirlemeye yönelik bir çalışma. *Ankara Hacı Bayram Veli Üniversitesi İktisadi ve İdari Bilimler Fakültesi Dergisi*, 22(3), 827–850.
- Mulimani, P. (2017). Green dentistry: The art and science of sustainable practice. *British Dental Journal*, 222(12), 954–961.
- Ones, D. S., & Dilchert, S. (2012). Employee green behaviors. *Managing Human Resources for Environmental Sustainability*, 32, 85–116.
- Ramirez-Rubio, O., Daher, C., Fanjul, G., Gascon, M., Mueller, N., Pajín, L., Plasencia, A., Rojas-Rueda, D., Thondoo, M., & Nieuwenhuijsen, M. J. (2019). Urban health: An example of a “health in all policies” A pproach in the context of SDGs implementation. *Globalization and Health*, 15(1), 1–21.
- Sachs, J. D., Schmidt-Traub, G., Mazzucato, M., Messner, D., Nakicenovic, N., & Rockström, J. (2019). Six transformations to achieve the sustainable development goals. *Nature Sustainability*, 2(9), 805–814.
- Sahamir, S. R., Zakaria, R., faizal Omar, M., Shakri, M. R., Chughtai, M. W., Mustafar, M., & Rooshdi, R. R. R. M. (2019). Energy Efficiency Criteria for Planning and Design of Green Hospital Buildings Rating System. *IOP Conference Series: Materials Science and Engineering*, 620(1), 12082.
- Schweitzer, M., Gilpin, L., & Frampton, S. (2004). Healing spaces: elements of environmental



design that make an impact on health. *Journal of Alternative & Complementary Medicine*, 10(1), 71–83.

Shan, M., & Hwang, B. gang. (2018). Green building rating systems: Global reviews of practices and research efforts. *Sustainable Cities and Society*, 39, 172–180.

Shih, Y.-Y., Lu, Y.-H., Liu, T.-Y., & Wu, M.-F. (2017). The staffs' adoption intention of knowledge management system in green hospital-the theory of technology acceptance model applied. *International Journal of Organizational Innovation (Online)*, 9(3), 27–35.

Wood, L. C., Wang, C., Abdul-Rahman, H., & Abdul-Nasir, N. S. J. (2016). Green hospital design: integrating quality function deployment and end-user demands. *Journal of Cleaner Production*, 112, 903–913.

Yali, Z., & Zheng, D. (2020). Double QSSE innovative hospital management model based on JCI standard and its application in private hospital in China. *Research Square*, 1–13.

Yoon, E., & Lim, Y. (2016). A Study on Green Building Certification Criteria for Healthcare Facilities - Focused on System and Contents for Healthcare in BREEAM, LEED, CASBEE. *Journal of The Korea Institute of Healthcare Architecture*, 22(3), 17–26.

Zhang, Y., Tzortzopoulos, P., & Kagioglou, M. (2019). Healing built-environment effects on health outcomes: Environment–occupant–health framework. *Building Research & Information*, 47(6), 747–766.



IMPORTANCE OF INTERSPECIFIC RAPESEED FORMS FOR HYBRID BREEDING

Emine YURTERİ

Dr. Öğretim Üyesi, Recep Tayyip Erdoğan Üniversitesi, Ziraat Fakültesi, Tarla Bitkileri Bölümü
ORCID NO: 0000-0002-3770-2714

Aysel Özcan AYKUTLU

Araş. Gör. Recep Tayyip Erdoğan Üniversitesi, Ziraat Fakültesi, Tarla Bitkileri Bölümü
ORCID NO: 0000-0001-5210-7617

Haydar KÜPLEMEZ

Araş. Gör., Recep Tayyip Erdoğan Üniversitesi, Ziraat Fakültesi, Tarla Bitkileri Bölümü
ORCID NO: 0000-0003-4094-1318

Fatih SEYİS

Prof. Dr., Recep Tayyip Erdoğan Üniversitesi, Ziraat Fakültesi, Tarla Bitkileri Bölümü
ORCID NO: 000-0001-9714-370X

Abstract

B. oleracea L., like other Brassica species, is a well-known species. The Triangle of U is formed by it and the other species *B. rapa*, *B. nigra*, *B. juncea*, *B. carinata*, and *B. napus*. Due to advancements in breeding and agronomical practice, genotypes developed from the genus Brassica have evolved globally to become the most important oil crops. Because of intensive breeding work beginning in the 1970s, genetic variation in rapeseed (*B. napus* L.) has become limited. If the desired variation is not present, species within related forms and species are used. To date, developed interspecific rapeseed (*Brassica napus* L.) forms have been characterized using morphological and molecular methods, and it has been determined that these forms represent a new gene pool.

Leafy cabbage (*B. oleracea* conv. *acephala*) is a traditional vegetable in the Black Sea Region. Cabbage genotypes with high vegetable oil quality can be easily crossed with leafy cabbage to produce seeds. The study's goal is to create Brassica genotypes that are genotypically similar to leafy cabbage and also contain vegetable oil quality. This material will be used to build a genetic infrastructure for selecting leafy cabbage genotypes with high grain yield and oil quality, serving as new gene pool for *B. napus* breeding. We know the gene pool of *B. napus* is narrow due to intensive breeding work during quality breeding in the 1970's. The possibility to use such material in Brassica breeding and the development of genotype harvested for two product purposes will be discussed in detail,

Keywords: Brassica, cabbage, breeding.

INTRODUCTION

In several nations throughout the world, amphidiploid rapeseed is commonly grown as a significant oilseed crop. In order to increase the variability of useful traits, such as seed quality and disease resistance to diseases like clubroot, which is known to harm vegetable brassicas and oilseed rape, it is highly desirable to search for forms with improved traits. From this perspective, interspecific crossing is a valuable tool (Dixon, 2009).

Rapeseed (*Brassica napus* L.) is a well-known interspecific hybrid of the diploid progenitors turnip rape and cabbage (*B. oleracea* L.) (*B. rapa* L.). Interspecific rapeseed (*B. napus* L.) forms were first difficult to use in yield breeding due to their limited yield capability. However, the ability to use interspecific rapeseed (*B. napus* L.) forms in hybrid breeding was made possible by the finding that they represent a novel gene pool. Researchers and canola producers appear to agree on the importance of increasing genetic variety in breeding programs for canola rapeseed (*Brassica napus*). Utilizing molecular markers to analyze diversity has revealed various gene pools that can be exploited to advance this crop. The development of novel rapeseed (*B. napus* L.) forms by interspecific hybridizations in an environment where extremely significant



possibilities and instruments for molecular biology and plant breeding are present demonstrates to us that this method has not lost any worth regarding its significance. In-depth discussion will be had regarding the use of interspecific rapeseed (*B. napus* L.) forms in hybrid breeding.

The Brassica Triangle

The Brassicaceae family contains about 330 genera and 3,800 species that are found all over the world (Bailey et al., 2006; Huang et al., 2016). Brassica is the most important genus because it contains many vital vegetables and oil crops (e.g., cabbage, broccoli, cauliflower, kale, and rapeseed). These economically significant plants are virtually entirely *Brassica rapa*, *Brassica juncea*, *Brassica nigra*, *Brassica carinata*, *Brassica oleracea*, and *Brassica napus*.

Based on artificial inter-specific hybridization studies, the U's triangle model was proposed to demonstrate the genetic links between these six species (Figure 1; Nagaharu, 1935). *B. rapa* (AA, $2n = 2x = 20$), *B. nigra* (BB, $2n = 2x = 16$), and *B. oleracea* (CC, $2n = 2x = 18$) are three basic diploid species, and three allotetraploid species were developed by natural hybridization and genome doubling, including *B. juncea* (AABB, $2n = 4x = 36$), *B. carinata* (BBCC, $2n = 4x = 34$), and *B. napus* (AACC, $2n = 4x = 38$)

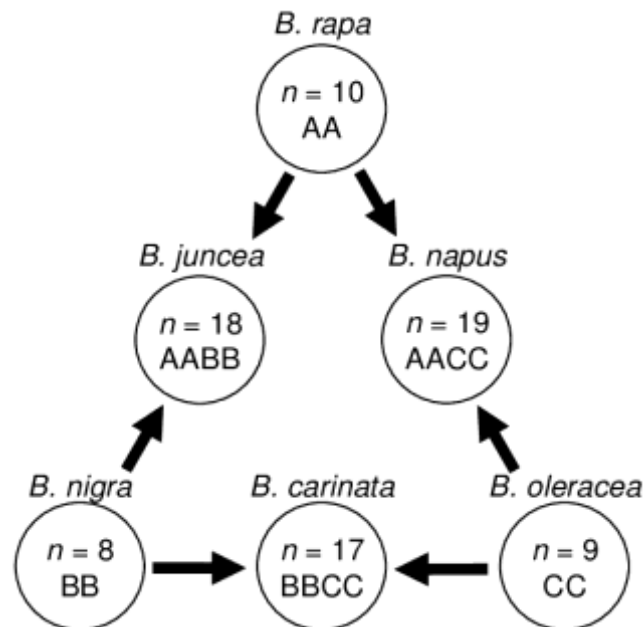

Fig. 1: According to U (1935), the Brassica triangle of species reflects the A, B, and C genomes and their corresponding amphidiploids, which were created through interspecific hybridizations in regions where their respective diploid progenitors' geographic distributions overlapped. Through meiotic nondisjunction, these hybridizations caused spontaneous chromosomal doubling.

Identification of Brassica oleracea variants with edible oil quality and white flower colour

Lühs et al. (2000) provided the first mention of *B. oleracea* genotypes lacking erucic acid. Ladozhkaya and Kashirka, two of these genotypes, were characterized by Seyis et al. (2004). Seyis and Friedt (2010) also studied the fatty acid composition of three *B. oleracea* genotypes, including Kashirka, Ladozhkaya, and Eisenkopf. They highlighted the genotypes' varied fatty acid contents, which ranged from 0% to more than 45% erucic acid. They sorted the samples into three groups based on erucic acid content: low, moderate, and high erucic acid. They also emphasized the possibility of enhancing quality and productivity in oilseed rape breeding by utilizing this fundamental material as a genetic resource.

The gene pool of the amphidiploid winter oilseed rape (*Brassica napus* L.) derives from a few spontaneous



interspecific hybridizations between *Brassica oleracea* and *Brassica rapa* centuries ago, and so has limited basis. Several methods for extending genetic variation in the *B. napus* gene pool with genetically distant material have been published, resulting in the addition of new alleles for agronomic properties (Girke et al., 2012).

The possibility of creating new variation will allow to increase the present gene pool of *B. napus* L. Therefore the presence of *B. oleracea* forms displaying edible oil quality and white flower colour is a good opportunity.

MATERIAL and METHODS

Using a BUCHI automatic oil extraction device, oil was extracted from seeds. For each genotype, 100 ml hexane was added to 5 gr powdered material and extracted for 90 minutes. The fatty acid composition of the genotypes under investigation was determined using a GC-MS apparatus (Rtx-2330 column, 30m, 0.32 mmID, 0.2 m) and a realted library. Investigated genotypes are given in Table 1:

Table : Investigated *Brassica oleracea* and *B. napus* genotypes

<u>Genotypes</u>	<u>Flower Colour</u>	<u>Location</u>
<i><u>Brassica oleracea</u> conv. <u>acephale</u></i>	White	Yomra
		Of
		Sürmene
		Çamlıhemşin
		Rize-1
		Rize-2
		Araklı-7
	Yellow	Araklı-6
		Araklı-5
		Araklı-4
		Araklı-3
		Araklı-2
		Araklı-1
		Kara Lahana (Arzuman)
<i><u>Brassica napus</u> L.</i>		<u>SamiBey 1</u>
		<u>SamiBey 2</u>
		Süzer 1
		Süzer 2

The current study included the local registrated rapeseed genotypes SamiBey and Süzer (00 quality) for fatty acid composition comparison.

RESULTS

Fatty acid composition of investigated material

The fatty acid composition of investigated Brassica material is given in Table 2.



The oleic acid and erucic acid percentages of white-flowered kale ranged between 7.89-22.86% and 32.80-64.52%, respectively. Yellow flowering cabbage contained 9.72-19.28% oleic acid and 46.60-62.56% erucic acid, respectively. The highest concentration of oleic acid was identified in the genotype Rize-1, at 22.86%, while the lowest was recorded at the genotype Of with 7.89%.

The commercial variety (Arzuman) from the Black Sea region contained the largest level of oleic acid in terms of fatty acids in the seed, with 19%. The Arakli-6 location had the least amount of oleic acid, with 9.72%. When the quantities of erucic acid were analyzed, they revealed an inverse relationship with oleic acid. There were no significant changes in fatty acid contents between cabbages with white and yellow flowers.

Oleic acid levels in commercial rapeseed cultivars ranged from 65.40% to 69.83%. Samibey-2 had the highest oleic acid concentration of any rapeseed variety, at 69.83%. While erucic acid was not detected in Samibey-1 or Süzer-1 cultivars, it was identified in low concentrations in other cultivars.

Table 2: Fatty Acid Composition of Investigated Brassica Genotypes

Genotypes	Flower Colour	Location	Palmitic	Stearic	Oleic	Linoleic	Linolenic	Eicosenic	Erucic
<i>Brassica oleracea</i> conv. <i>acephale</i>	White	Yomra	3.84	0.84	16.08	13.68	4.59	9.03	51.93
		Of	3.68	0.31	7.89	13.40	7.18	3.03	64.52
		Sürmene	2.60	0.28	11.48	12.36	5.58	4.56	63.15
		Çamlıhemşin	2.89	0.27	10.44	12.52	8.18	4.77	60.92
		Rize-1	7.53	0.72	22.86	26.32	3.97	5.79	32.80
		Rize-2	3.55	0.57	15.03	11.94	5.27	6.78	56.87
		Araklı-7	3.62	0.32	12.73	16.47	7.19	5.55	54.13
	Yellow	Araklı-6	2.81	0.00	9.72	13.34	7.19	4.39	62.56
		Araklı-5	4.49	0.40	12.62	14.62	8.71	4.72	54.45
		Araklı-4	3.78	0.47	11.20	14.87	6.18	4.51	59.00
		Araklı-3	3.07	0.46	11.36	13.49	7.24	4.32	60.05
		Araklı-2	3.08	0.24	11.03	13.90	6.18	4.31	61.26
		Araklı-1 Kara Lahana (Arzuman)	5.13	0.66	19.28	15.35	7.29	5.68	46.60
<i>Brassica napus</i> L.		SamiBey 1	5.19	0.84	65.40	21.18	6.12	1.16	0.21
		SamiBey 2	3.62	0.70	69.83	19.89	5.06	0.90	0
		Süzer 1	3.78	0.74	68.41	20.43	5.05	1.59	0
		Süzer 2	5.49	0.72	66.16	20.96	5.22	1.20	0.26

As

expected our leafy cabbage genotypes displayed high amounts of erucic acid.

Planning of Future Work

The above-mentioned *B. oleracea* forms with edible oil quality are the first step for developing interspecific hybrids using *B. rapa* with 00-quality. On the other hand, leafy cabbage is famous plant in Turkey, specially the Black Sea region. Further, the detection of genotypes with white petal colour give us the idea to cross these genotypes with cabbage genotypes to develop a high number of cabbage populations.

A large number of cabbage populations will be developed as a result of intraspecific crosses. Using genetic marker systems, genotypes that look similar to leafy kale but have edible oil quality will be selected in the following generation (Fig. 1).



DISCUSSION

Resynthesised (RS) rapeseed genotypes developed through interspecific crosses between diverse *B. rapa* and *B. oleracea* genotypes have the potential to significantly increase the available gene pool and provide important basicgermplasm for further improvements of seed yield, seed quality traits, disease and pest resistance (Seyis et al., 2010).

With the first step of developing new genetic material in *B. oleracea* the way will be opened to develop new interspecific variation for the gene pool of *B. napus* L.

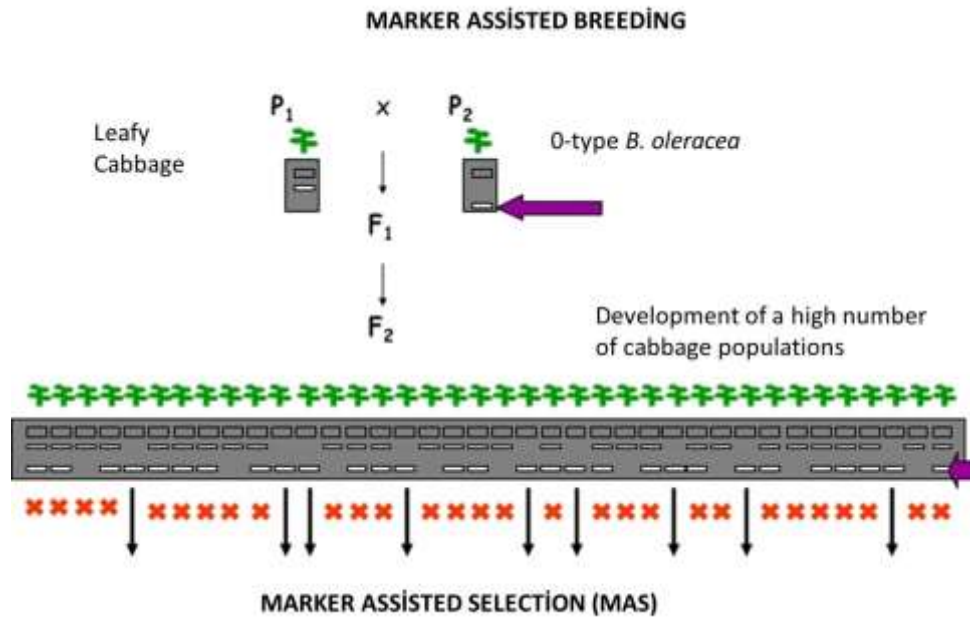

Fig.1: Selection of kale genotypes with edible oil quality/white petal colour using MAS (Marker Assisted Selection)

CONCLUSION

It is generally known that intensive selection and quality breeding have limited the gene pool of *B. napus*. As a result, new gene pools are required. *B. oleracea* is also known to be the diploid progenitor of *B. napus*. The gene pool of *B. oleracea* will be expanded with the production of novel leafy kale genotypes in terms of white petal color and edible seed oil quality. These genotypes may serve as the foundation for newly produced *B. napus* interspecific hybrids, which may also serve as the foundation for producing new genetic variety in the *B. napus* gene pool.

REFERENCES

- Bailey C D, Koch MA, Mayer M, Mummenhoff K, O’Kane SL, Warwick SI., Windham MD, Al-Shehbaz A 2006. Toward a global phylogeny of the Brassicaceae. *Mol. Biol. Evol.* 23, 2142–2160.
- Dixon GR 2009. The occurrence and economic impact of *Plasmodiophora brassicae* and clubroot disease. *Journal of Plant Growth Regulation*, 28, 194–202.
- Lühs W, Seyis F, Voss A, Friedt W 2000. Genetics of erucic acid content in *Brassica oleracea* seed oil. *Czech Journal of Genetics and Plant Breeding*, 36: 116-120.
- Nagaharu U 1935. Genome analysis in *Brassica* with special reference to the experimental formation of *B. napus* and peculiar mode of fertilization. *Japan Journal of Botany*, 7: 389–452.



INTERNATIONAL ASIAN CONGRESS ON CONTEMPORARY SCIENCES – VII

- Seyis F, Friedt W, Voss A, Lühs W 2004. Identification of individual Brassica oleracea plants with low erucic acid content. *Asian Journal of Plant Sciences*, 3 (5): 593-596.
- Seyis F, Friedt W 2010. Brassica oleracea genotypes displaying interesting fatty acid profiles for Brassica napus breeding. *African Journal of Agricultural Research*, 5 (23): 3191-3195.
- Seyis F, Friedt W, Lühs W 2010. Yield of Brassica napus L. Hybrids Developed Using Resynthesised rapeseed material. *Anadolu Tarım Bilimleri Dergisi*, 25 (3): 159-167.
- Seyis, F, Aydin E 2013. Importance of interspecific rapeseed (Brassica napus L.) hybrids in hybrid breeding. *Journal of Agricultural Science Research*, 6(2): 109-117.



IMPORTANCE OF TEA SEED OIL AND POSSIBLE PRODUCTION IN TURKEY

Emine YURTERİ

Dr. Öğretim Üyesi, Recep Tayyip Erdoğan Üniversitesi, Ziraat Fakültesi, Tarla Bitkileri Bölümü

ORCID NO: 0000-0002-3770-2714

Aysel Özcan AYKUTLU

Araş. Gör., Recep Tayyip Erdoğan Üniversitesi, Ziraat Fakültesi, Tarla Bitkileri Bölümü

ORCID NO: 0000-0001-5210-7617

Haydar KÜPLEMEZ

Araş. Gör., Recep Tayyip Erdoğan Üniversitesi, Ziraat Fakültesi, Tarla Bitkileri Bölümü

ORCID NO: 0000-0003-4094-1318

Fatih SEYİS

Prof. Dr., Recep Tayyip Erdoğan Üniversitesi, Ziraat Fakültesi, Tarla Bitkileri Bölümü

ORCID NO: 000-0001-9714-370X

Abstract

Tea (*Camellia sinensis*) arised to the biggest income of local farmers in the Black Sea Region of Turkey in the last three decades. As well known the tea production in Turkey is more focussed on black tea production with some green tea production in the last years. Products like white tea and green tea powder can be seen also on the product pipeline in recent years. But considering the tea plant regarding its oil content is very new in Turkey, displaying huge potentail in future. Tea seeds are containing about 30 % oil, representing fatty acid composition as edible oil.

Tea oil has a pleasant, mellow aroma that pairs well with anything. This oil has tremendous health benefits along with a mild flavor and a nice aroma reminiscent of tea. In comparison to olive oil, tea seed oil has a higher smoke point, more monounsaturated fatty acids, less saturated fatty acids, high levels of vitamin E, polyphenol antioxidants, and both omega-3 and omega-6 fatty acids, but less omega-6 and polyunsaturated fats. To achieve its health benefits, camellia oil can be used both topically and orally.

Turkey has a tea production area of nearly 82.000 ha, mostly harvested for tea leaves. A specific area could be seperated for tea oil production, of course we have to notice that cultivationn practices has to be changed because this kind of production will focuss only on obtaining seeds.

With the selection of high oil yielding genotypes a alternative income will be presented for local farmers, who are interested in such production activities. The importanceof tea seed oil and opportunities will be discussed in detail.

Keywords: Camellia, seed oil, breeding

INTRODUCTION

In the Eastern Black Sea Region, from the Georgian border up to the Fatsa district in Ordu, tea production is practiced. Rize, Ordu, Giresun, and Trabzon are the primary tea-producing cities in this region (Anonymous 2015). These regions are found in the top zone if we take into account the locations of the world that produce tea.

The tea plant (*Camellia sinensis*), which belongs to the Theaceae family, also produces big, oily seeds. Tea seed oil has been recognized as edible oil in various nations where it is widely accessible



(Sahari et al., 2004).

Camellia oleifera and *Camellia sinensis* seeds are used to make tea seed oil, a cold-pressed edible oil. Tea seed oil is regarded in Chinese herbal medicine as a super nutritional dietary supplement that improves the immune system, controls the nervous system, lowers blood pressure, and benefits the digestive system. Due to its high nutritional value, which is comparable to that of olive oil in terms of its health benefits, tea seed oil is recommended by the Food and Agriculture Organization of the United Nations as a premium, nutritious vegetable oil.

TEA SEED

Tea [*Camellia sinensis* L. (O.) Kuntze] seeds are difficult to store and transport because they are refractory and have been observed to lose viability quickly. When handling, sowing, packing, and storing a recalcitrant type of seed, additional attention and safety precautions were required. Specific cultural methods and precautions against pests and diseases are particularly important for the production of viable, healthy, and better hybrid seeds from pollination to seed development. In addition to hybrid vigor, tea seed components can be used to make tea seed oil and cattle manure from oil cake. These ancillary goods can be used commercially and have significant economic worth as well (Patel, 2018).

TEA SEED OIL

An oleaginous seed is produced by every member of the *Camellia* genus. Tea seed was used to make crude edible oil in native mills in West Bengal, Himachal Pradesh, Assam, and the northern part of Indochina (Owuor et al., 1985). In 1958, 180,000 tons of tea seed oil were produced on a commercial basis in China (Sengupta et al., 1986).

Tea seed oil is the name given to the oil that is produced from the seeds of both wild and domesticated *Camellia* species. Even though *C. sinensis* is primarily grown for commercial tea production, oil is not typically extracted from this species. Species including *C. sasanqua*, *C. japonica*, *C. tenuifolia*, and *C. oleifera* are used in the commercial production of oil. Different varieties of *Camellia* seeds contain 20–70% oil, which is similar to olive (*Olea europaea*) oil in quality (Table 1 and 2). As a result, it might be used as a substitute for other edible oils as well as olive oil. The tea seed oil has a pleasant odor, is yellow in color, free-flowing, and may be kept at room temperature for three months without losing any quality (Roberts and De Silva, 1972). According to Rajaei et al. (2008), the fatty acid composition of *C. sinensis* seed oil was 56.5% oleic acid, 22.2% linoleic acid, and 0.3% linolenic acid, with 21.5% palmitic acid and 2.9% stearic acid (Sahari et al., 2004).

Oleic acid made up half of the total amount of fatty acids in the *C. sinensis* seed oil (Rajaei et al., 2005). *C. sinensis* seed oil can therefore be positioned between sunflower and olive oil in terms of oleic acid content (Sahari et al., 2004). UFA and SFA content in the extracted oils ranged from 58.1 to 71.7% and 17.4 to 23.7%, respectively (Rajaei et al., 2005). Due to its low concentrations of the polymerizing substances C18:2 and C18:3, this oil has a low tendency to dry (Sahari et al., 2004). According to earlier research, the primary components of *C. oleifera* Abel oil were oleic, linoleic, palmitic, and stearic acids, with an average amount of MUFA, PUFA, and SFA of 51.06%, 27.86%, and 20.67%, respectively (Hua et al., 2008).

**Table 1:** Oil Content in different *Camellia* species compared with other oil crops

Species	Per cent oil (Dry weight basis)
<i>C. sasanqua</i>	60-70
<i>C. japonica</i>	66-70
<i>C. oleifera</i>	40-50
<i>C. tenuifolia</i>	40-50
<i>C. sinensis</i> (Common tea)	20-30
Groundnut	44-50
Olive (Common olive)	15-40
Sunflower	35-48
Mustard	30-48

Owuor et al. (1985); Kamanga (1985), Anonymous (1950)

According to earlier research, the primary components of *C. oleifera* Abel oil were oleic, linoleic, palmitic, and stearic acids, with an average amount of MUFA, PUFA, and SFA of 51.06%, 27.86%, and 20.67%, respectively (Hua et al., 2008). Additionally, there are 75.89% of UFAs, with 73.83% of those being primarily oleic and linoleic acid (Weiming et al., 1992).

Table 2: Fatty acid composition of *C. sinensis* seed oil

Fatty acids	Tea seed oil (%)
C16:0	16.50
C18:0	3.33
C18:1	65.97
C18:2	22.17
C18:3	0.30
C20:0	0.53
PUFA	22.47

Weiming et al. (1992)

USE of TEA SEED OIL

The oil derived from tea seeds resembles groundnut and olive oils in many ways. Tea seed oil can be used to create high-quality creams, hair oils, soaps, and detergents. In reality, olive oil has been adulterated with tea seed oil (Chakravarty et al., 1954). It is known that tea seeds contain a significant amount of saponin. From the seeds of *C. sinensis*, "theasaponin" has been isolated. Tea seeds include Theasapogenal A, B, C, D, and E, which are five saponins that have been identified Yoshioka et al. (1970). These saponins have been reported to have strong antiexudative and anti-inflammatory effects in addition to their effective detergent activity (Tschesche and Wulff, 1973). The processing of photographic films can also be done with soap (Goffe, 1969).

The tea plant is primarily grown for its prodigious vegetative growth. Furthermore, tea plants produce a lot of oil (30–32%), and their seeds are a useful product with a variety of uses. This oil is a crucial vegetable oil due to its high level of unsaturated fatty acids, particularly vital linoleic acid, and low content of saturated fat (Sahari and Amooi, 2013). Additionally, tea seed oil lowers blood pressure and cholesterol levels and works to prevent a number of degenerative disorders, such as cancer and cardiovascular disease. Similar to olive oil, tea seed oil is a high-quality cooking oil with great preservation qualities since it contains a lot of polyphenols, which act as antioxidants.



POSSIBLE PRODUCTION of TEA SEED OIL IN TURKEY

In Turkey tea leaves are used mainly for the production of black tea and in minor amounts for green tea production. In the last decades the importance of white tea leaves arised. But products which could be developed from the tea plant are not well known in Turkey. The Camellia seed oil is one of them.

The total tea production are in Turkey is about 83.000 ha. All produced green leaves and white tea leaves are bought mainly from side of ÇAYKUR and the private sector.

The fresh leaves are harvested mainly in three periods (Mai, July and September) and seeds are obtained mainly after the last harvest period up to January depending on convenient climatic conditions.

If the to be produced seed oil will be supported by side of ÇAYKUR and if the product corresponds to a suitable price in the market the local farmers have to be educated regarding tea seed oil production. At the end a new alternative product inside tea agriculture will be presented on the market with possible prolongation to tea honey production.

CONCLUSION

Oil-rich seeds are a byproduct of all species in the genus *Camellia*. Because it contains a lot of unsaturated fatty acids, particularly crucial linoleic acid, which is known to lower blood cholesterol levels, tea seed oil is one of the most significant vegetable oils from the standpoint of nutrition. The chemical characteristics, fatty acid makeup, and triacylglycerol species of this oil generally dictate its optimum nutritional and economic applications. It also contains a little quantity of linolenic acid, which is crucial for preventing rancidity and off flavors in oils during storage. Some areas of these plants may be divided to produce tea oil and tea honey in Turkey once the yield of the current plantings has been increased and suitable genotypes have been identified.

REFERENCES

- Anonymous 1950. *Camellia*. In "Wealth of India" 2: 27-50.
- Anonymous 2015. Türk Çay Sektörü. Güncel Durum Raporu. Rize Ticaret Borsası. (Turkish Tea Sector. Actual Situation Report. Rize Exchange Commodity).
- Anonymous, (2020). ÇAYKUR Faaliyet Raporu. (Activity Report, ÇAYKUR)
- Berjak P, Vertucci CW, Pammenter NW 1993. Effects of developmental status and dehydration rate on characteristics of water desiccation sensitivity in recalcitrant seeds of *Camellia sinensis*. *Seed Science Research*, 3:155-166.
- Chakravarty SR, Chakravarty MM 1954. *Indiantea* seed. *Indian Soap Journal*, 20:16-19.
- Goffe GA 1969. U.S. Patent No. 3433639.
- Hua G, Jianping Z, Junwu L, Huiyuan T, Dongmin L 2008. Fatty acid composition analysis of tea seeds oil. *China Oils and Fats*.
- Kamanga KDE 1985. Tea seed oil project. TRFCA. *Quarterly Newsletter*, 79: 29-30
- Owuor PO, Chauanji AM, Manavu RM 1985. Chemical studies of the Kenian tea seeds I. Physical and chemical characteristics of the Kernel oil. *Tea*, 6 (1):23-28.
- Patel Pk, Das B, Sarma R, Gogoi B 2018. Tea Seed: A Review. *Annual Research & Review in Biology*. 25. 1-14.
- Rajaei A, Barzegar M, Yamini Y 2005. Supercritical fluid extraction of tea seed oil and its



- comparison with solvent extraction. *European Food Research and Technology*, 220: 401-405.
- Rajaei A, Barzegar M, Sahari MA 2008. Comparison of antioxidative effect of tea and sesame seed oils extracted by different methods. *Journal of Agricultural Science and Technology*, 10: 345-350.
- Roberts GR, De Silva ULL 1972. Products from tea seed 1. Extraction and properties of oil. *Tea Q.*, 43 (3): 88-90.
- Sahari MA, Atai D, Hamedi M 2004. Characteristics of tea seed oil in comparison with sunflower and olive oils and its effect as a natural antioxidant. *Journal of the American Oil Chemists' Society*, 81: 585- 588.
- Sahari MA, Amooi M 2013. Tea seed oil: Extraction, compositions, applications, functional and antioxidant properties. *Academia Journal of Medicinal Plants*, 1(4): 068-079.
- Sengupta C, Sengupta A, Ghosh A, 1976. Triglyceride composition of tea seed oil. *Journal of Science Food and Agriculture*, 27: 1115-1122.
- Tschesche VR, Wulff G 1973. *Chemie und Biologie der Saponine*. In: *Fortschritte der chemie organischer naturstoffe*. Springer Vienna, pp. 461-606.
- Weiming Z, Guorong W, Botao Z, Hong W, Shirong C 1992. Studies on the chemical components of tea seed oil and cake. *Nanjing Normal Univ Nat Sci*, Edition 3.
- Yoshioka T, Nishimura T, Matsuda A, Kitagawa 1970. *Chemical Pharmacology Bulletin (Tokyo)*, 18:1610



REKREASYON İŞLETMELERİNDE PARANIN DİJİTAL DÖNÜŞÜMÜ

Zehra ALAKOÇ BURMA

Mersin Üniversitesi, Mersin Meslek Yüksekokulu, Mersin, Türkiye

ORCID-ID: 0000 0002 0376 516X

Caner SALTİK

Mersin Üniversitesi, Rekreasyon Bölümü Yüksek Lisans Öğrencisi, Mersin, Türkiye

ORCID-ID: 0000-0002-3551-607X

Özet

Günümüzde küreselleşen dünya ile birlikte yaşanan hızlı teknolojik gelişmeler sonucu kişiler, toplumlar, iş sektörleri ve devlet yönetimleri yoğun bir dijital dönüşüm süreci yaşamaktadırlar. Bu dijital dönüşümün sonucunda; her alanda eski ve geleneksel olan yöntemler terk edilmekte, dönüşümün gerekleri ile her alanda yeni ve çağdaş yöntemler tercih edilmektedir. Aslında; hiç bitmeyecek bir süreç olarak yaşanan bu dijital dönüşüm, her geçen gün çok daha hızlı bir şekilde gelişmekte, dünyamızı dönüştürmekte ve bu bağlamda dijital dönüşüm sürecini sürekli güncellemektedir. Bu çalışmanın amacı; rekreasyon kapsamında; paranın dijital dönüşümünü ve bu dönüşümün rekreasyonel işletmelerdeki etkilerini araştırmaktır. Çalışmada; dünyada ve ülkemizde dijital değişim olgusunun para sistemleri özelinde ne gibi dönüşümler yapmakta olduğu açıklanmaya çalışılmış ve dönüşümün gelecekte bu para sistemlerini nelerin beklediğine yönelik bulguları saptanmaya çalışılmıştır. Çalışmanın ilk bölümünde paranın tarihsel serüvenine odaklanılmıştır. İkinci bölümünde ise paranın dijital dönüşümü analiz edilmiştir. Bu bölümde; para, dijital para, kripto para (bitcoin ve altcoins) ve blokzincir teknolojisi detayları ile anlatılmaya ve açıklanmaya çalışılmıştır. Çalışmanın son bölümünde; paranın dijital dönüşümünün rekreasyonel ve dijital rekreasyon alanlardaki kullanımı, bu kullanımın beraberinde getirdiği dijital güvenlik, psikolojik güvenilirlik, merkeziyetsiz paralar ve bu paraların finansal işlemlerine vurgu yapılmıştır. Ayrıca; paranın dijital dönüşüm sürecinin bizlere ve dünyamıza nasıl bir gelecek dizayn ediyor olabileceğine yönelik fikirselle ve fütüristik görüşler de yer almaktadır. Çalışmada nitel veri yöntemlerinden literatür taraması yöntemi kullanılmış, ilgili arşiv incelenmiş ve elde edilen veriler kavramsal analiz süreci ile işlenmiştir.

Anahtar Kelimeler: Rekreasyon, Dijital Rekreasyon, Dijital Para, Sanal Para, Kripto Para, Blokzincir Teknolojisi



DIGITAL TRANSFORMATION OF MONEY IN RECREATION BUSINESSES

Abstract

Today, as a result of rapid technological developments with the globalizing world, individuals, societies, business sectors and government administrations are experiencing an intense digital transformation process. As a result of this digital transformation; old and traditional methods are abandoned in every field, new and contemporary methods are preferred in every field with the requirements of transformation. Actually; This digital transformation, which is experienced as a never-ending process, is developing much faster with each passing day, transforming our world and constantly updating the digital transformation process in this context. The aim of this study; within the scope of recreation; to investigate the digital transformation of money and the effects of this transformation in recreational businesses. In the study; It has been tried to explain what kind of transformations the phenomenon of digital change is making in the world and in our country in terms of monetary systems, and the findings of the transformation about what awaits these monetary systems in the future have been tried to be determined. The first part of the study focuses on the historical adventure of money. In the second part, the digital transformation of money is analyzed. In this chapter; money, digital money, virtual money, crypto money (bitcoin and altcoins) and blockchain technology have been tried to be explained and explained in detail. In the last part of the study; The use of the digital transformation of money in recreational and digital recreation areas, the digital security brought by this use, psychological reliability, decentralized money and the financial transactions of these currencies were emphasized. Moreover; There are also intellectual and futuristic views on how the digital transformation process of money can design a future for us and our world. In the study, the literature review method, one of the qualitative data methods, was used, the relevant archive was examined and the obtained data were processed with the conceptual analysis process.

Keywords: Recreation, Digital Recreation, Digital Money, Virtual Money, Crypto Money, Blockchain Technology

Giriş

Günümüz toplumlarında her alanda, çok hızlı teknolojik gelişmeler olmakta ve bunun sonucunda da sürekli olarak değişim ve dönüşümler yaşanmaktadır. Bu alanlardan bir tanesini de para sistemleri özelinde, finans alanı oluşturmaktadır (Alpago, 2018). Yaşanan toplumsal dönüşümün en yoğun hissedildiği alan dijital alanlardır; hatta denilebilir ki dijital alanlardaki bu hızlı dönüşüm, toplumları ve kişileri de dönüştürmektedir. Eskiden en kısa vadede yüz yıllık süreçlerde kendisini gösteren bu toplumsal dönüşüm izlenimleri, günümüz toplumlarında on yıl gibi kısa bir sürede oluşmaktadır. Dönüşümün itici gücü teknolojik yenilikler olduğu için; dijital dönüşüm olgusu da sadece akademik çevrelerde değil; toplumun her kesiminde tartışılmakta ve üzerine fikir yürütülmektedir.

Teknolojinin hızla geliştiği yirmi birinci yüzyıl, her alanda olduğu gibi para sistemlerinde de; bugüne özgü doğan ihtiyaçları karşılamak için çeşitlenmiş ve dönüşüm geçirmiştir. Bu dönüşümde hem dijital para, sanal para, kripto para sistemleri, bitcoin ve altcoins türevi para sistemleri hem de mevcut para politikaları değişim ve dönüşüme uğramıştır. Bu şartlar altında ortaya çıkan sanal para birimi (SPB) kavramı, geleneksel ödeme araçları ve finansal hizmetlerin karşılamakta zorlandıkları yeni tüketici talepleriyle şekillenen bir varlık türü olarak görülebilir (Üzer, 2017). İhtiyaçlar sonucu yaşanan bu değişim ve dönüşümler gelecekte de yeni değişim ve dönüşümleri de beraberinde getirecektir.



Paranın dijital dönüşümündeki en etkili ortam Internetle birlikte gelişen elektronik platformlar olmuştur. Bu platformlarda yapılan havale, EFT, Swift gibi işlemlerde karşılaşılan minimum ve maksimum işlem limitlerinin olması, alınan işlem masraf ücretlerinin yüksek olması ve işlemlerin geri dönülmezliğinin tam anlamıyla sağlanamaması ve güvenilir bir üçüncü taraf olmadan ödeme yapmaya olanak verecek bir mekanizmanın bulunmaması; sistemde yeni alternatif para sistemi arayışlarını beraberinde getirmiştir. Sonuç olarak mevcut ödeme mekanizmalarının bu eksiklikleri dijital para birimlerinin ortaya çıkmasına neden olmuştur. Mevcut ödeme sistemindeki eksiklikleri gidermek veya yeni alternatifler çözümler sunmak için ortaya çıkan dijital para birimleri kısa zamanda gerek finans dünyasında gerekse günlük hayatımızda yerini almıştır.

Ülkemizde dijital para birimlerinin kullanımı, teknolojik altyapısı, finansal çevrelerdeki etkinliği ve diğer akademik alanlarla olan ilişkileri konularıyla ilgili araştırmalar sınırlıdır. Bu çalışmada; geçmişten günümüze paranın dönüşümü kapsamında; para, dijital para, sanal para, kripto para, kripto paralar içerisinde en bilinen Bitcoin ve onun alternatifleri altcoinler'in ortaya çıkışı, para sisteminin işleyişi, bu paraların özellikleri, kullanıldığı piyasaları, avantaj ve dezavantajları gibi konular incelenmiştir. Ayrıca; paranın dijital dönüşümü ve rekresyonel işletmelerdeki kullanımı incelenmiş ve çalışmanın bulguları kapsamında bir takım fütüristik çıkarımlar yapılmıştır. Para ve ödeme sistemlerine yansıyan yeni teknolojik gelişmeler ve yaşanan dönüşümler, insanların paraya karşı olan algıları, dünyadaki dijital para dönüşümü ve bunun dünya ekonomik sistemini dönüştürme potansiyali de bu çalışmanın amaçlarından biridir.

1. Paranın Serüvenine Kısa Bir Bakış

İnsanlar ekonomik faaliyetlerini avcılık ve toplayıcılık ile sürdürdükleri zamanlarda paraya ihtiyaç duymuyorlardı. Küçük topluluklar halinde yaşayan insanlar, ihtiyaçlarını kabile üyeleri arasında gerçekleşen takas yöntemi ile karşılıyorlardı (Ponting, 2000). Bu ekonomik yöntemin adı takas, mübadele ya da trampa ekonomisi olarak da geçmektedir. Aristoteles' e (1975) göre bu yöntem, ekonomi sistemlerinin en eskisidir. Takas ekonomisi mal ya da hizmetlerin değiş tokuş edildiği basit bir ekonomik sistemdir; ancak kendi içinde çok ciddi sorunlar barındırmaktadır. Takas ekonomisinde öncelikle değiş tokuşu yapmak isteyen tarafların karşı karşıya gelmesi gerekmektedir. Birbirinin mal ya da hizmetine ihtiyaç duyan kişilerin bir araya gelmesi her zaman mümkün olmamaktadır. Bu durum takas ekonomisinin birinci zorluğunu oluşturmaktadır. İkinci ve daha büyük zorluk ise; taraflar bir araya gelseler bile değiş tokuşu hangi değişim oranı üzerinden yapacaklarıdır. Takas ekonomisinde belirlenmiş ve yetki sahibi otorite tarafından güvence altına alınmış bir değişim oranı mevcut (Kamalak, 1980) değildi.

Tohumun keşfi ve tarımın başlaması ile insanlık tarihinde yeni bir sayfa açılmıştır ancak bu durumda özellikle ilk başlarda mevcut ekonomik sistemde pek fazla ve radikal değişimler oluşturmamıştır. İnsanlar yine küçük topluluklar halinde yaşıyorlardı ve ihtiyaç duyulan mal ve hizmetler topluluk içinde takas yöntemi ile karşılanabiliyordu. Zamanla nüfusun artması ve insanların şehirler kurarak daha büyük topluluklar halinde yaşamaya geçmeleri, iş bölümü ve uzmanlaşmayı beraberinde getirdi. İş bölümü ve uzmanlaşma ise; ürün çeşitliliğinin artmasına sebep oldu. Devletlerin kurulması ile şehirlerarası ticaret artmaya başladı. Takas ekonomisi artık mevcut ihtiyaçlara cevap veremez duruma gelmeye başladı. Sınırlı sayıda ürünün el değiştirdiği küçük topluluklarda takas iyi ve yeterli bir yöntem iken; ürün çeşitliliğinin arttığı büyük topluluklarda takas ekonomisi, karmaşık ekonomik sistemin ihtiyaçlarına cevap veremiyordu. Takas ekonomisinin en zayıf yanı, sabit bir değişim oranının olmamasıdır. Ayrıca bir takasın gerçekleşebilmesi için tarafların karşılıklı isteklerinin birbirine uyması gerekmektedir. Ürün çeşitliliğinin ve dolayısı ile ihtiyaçların arttığı bir toplumda bu pekte mümkün olmamaktadır. Takasın sağlıklı bir şekilde yapılabilmesi için tüm mal ve hizmetlerin değerini belirleyecek bir şeye ihtiyaç duyulmaya başlanmıştır. Bu ihtiyaç neticesinde insanların zihninde para kavramı oluşmaya başlamıştır (Harari, 2012/2015).



Madeni paralar bazı kaynaklarda temsili para, bazı kaynaklarda emtia para olarak geçmektedir. İlk kullanılan paralar mal paralardır. Değişim aracı olarak kullanılmasa bile bir değeri olan malların değişim aracı olarak kullanılmasına mal para sistemi (Fidan, Dilek, Esev, 2019) denilmektedir. Deniz kabuğu, hayvan derisi, tuz, tohum, boncuk, kumaş, arpa v.b. mallar çeşitli kültürler tarafından mal para olarak kullanılmıştır. Tarihsel süreçler içerisinde en yaygın olarak kabul gören mal paralar altın ve gümüşdür. Mal paraların depolanması ve taşınabilmesinin oldukça zor ve maliyetli olması bu para sistemin en belirgin zayıf yanlarıdır.

Mal paraların bünyesinde barındırdığı temel zorluklar ve sorunlar zamanla madeni paralar dediğimiz para biriminin oluşmasına neden olmuştur. Mal paraların bünyesinde barındırdığı zorluklar ve sorunlar MÖ 6.-7. yüzyıllarda Lidyalılar tarafından ilk madeni paranın basılması ile çözüme kavuşmuştur. Madeni paranın kullanılmaya başlanması ile birlikte başta ticaret olmakla beraber ekonomik hayattaki pek çok şey dönüştü ve kolaylaştı. Devlet işlerinde askerlerin ve devlet görevlisi olan memurların maaş ödemeleri madeni para sistemi ile çok daha düzenli ve kolay yapılır hale geldi. Ticaret ve devlet yönetimin dışında madeni paraların bir diğer çok önemli işlevi ise politik işlevidir.

Tarihsel süreçler içerisinde paranın şekli, biçimi, yapıldığı materyal (maden, kâğıt v.b.), arkasındaki otorite sürekli değişmiştir; ancak paranın üstlendiği fonksiyonlar neredeyse hep aynı kalmıştır. Paranın kullanılmaya başlandığı ilk zamanlardan günümüz kadar paranın işlevleri üç başlık altında toplanabilir;

- Para bir mübadele aracıdır.
- Para kolay taşınabilir ve saklanabilir olmalıdır.
- Para bir değer muhafaza aracıdır.

Bu üç fonksiyonu bünyesinde barındıran her şey para olabilir. Dolayısı ile tarihsel süreçlerde mal paralardan sonra banknotlar, kâğıt ve madeni paralar kullanılmıştır. Günümüzde ise parasal ve finansal sistem tekrardan ve kökünden bir dönüşüm süreci içerisine girmiş ve dijital paralar ve kripto paralar ekonomik faaliyetlerde kullanılmaya başlanmıştır.

2. Paranın Dijital Dönüşümü

Günümüzde her alanda giderek artan ve hiç kesintiye uğramadan devam eden sürekli bir dönüşüm yaşanmaktadır. Paranın tarihsel serüveninde de görüldüğü gibi, mevcut para sistemleri yeni durumlara ayak uyduramadığı, yeni istek ve taleplere cevap veremediği durumlarda bir dönüşüm sürecine girmiş, eski para sistemlerine alternatif veya ek özellikleri olan yeni para sistemleri oluşturulmuş ve artık bundan sonra bu yeni para sistemleri de kullanılmaya başlamıştır. Günümüzde *dijital para*, *sanal para* ve *kripto para* bu dönüşümün sonucudur. Bu yeni dönüşümlerin önceki dönüşümlerden temel farkının; paraların fiziksel olarak olup olmadıkları, paraların üst yetki sahibi ve yöneticilerinin kimler olduğu, otoritesinin kime ait olduğu, hangi kitlelerce kullanıldığı, geçerliliğinin dünyada nereleri kapsadığı gibi farklarının olmasıdır.

Paranın Dijital dönüşümü; teknolojik gelişmeler sonucu para sistemleri alanında yaşanan değişim ve dönüşüm sürecine verilen isimdir. Kâğıt ve madeni paraların kullanımının yanında paranın kredi kartı ile kullanımı, havale, EFT ve SWAP ile dolaşımının sağlanması paranın dijital dönüşümünün ilk aşamasıdır. Ancak bunlar kişi ve kurumların banka hesaplarındaki mevduatlarına endeksli olup aynı zamanda da merkez bankası denetiminde bulunmakta idiler (Alpago, 2016). 2008 yılına kadarki bu ilk aşamada tüm para ve para benzeri araçlar ülkelerin merkez bankaları tarafından tedavüle çıkarılıp, ilgili yasalara göre merkezi otoriteler tarafından yönetiliyordu. Yani paralar merkezi yapıda idiler.

2008 yılında klasik para sistemine ek olarak elektronik ortamda üretilen dijital para sistemleri geliştirildi. Dijital para sistemlerine bazı kaynaklarda sanal para sistemleri de denilmektedir. Bu yeni



sistemde madeni veya kâğıt para kullanılmamış onun yerine geçen sanal paralar kullanılmıştır. 2008 yılında Satoshi Nakamoto tarafından oluşturulan ve bitcoin olarak adlandırılan sanal para sistemi ile paranın merkez bankası ve resmi merciler olmadan özel şahıslar tarafından tedavüle çıkarılması mümkün olmuştur (Alpago, 2018). Yani paralar merkezi olmayan yapıda oluşturulmuştur.

Dijital para sisteminin bir alt dalı olan kripto para sistemindeki paralar; bu parayı oluşturanlar ve bu paraya sahip olanlar için bir kamu otoritesine vergi veya benzeri ödeme yapmadan alım satım yapılarak kullanıcıya mali bağımsızlık sağlamaktadır. Bu sistemi kullananlar; parayı oluşturma ve sahip oldukları kripto paraları bu paraların kabul edildiği şirketlerde 7 gün 24 saat işlem yapabilmek için para gibi kullanabilmektedir. Bu sistemde komisyon için çok düşük düzeyde ücret alınmakta, para gönderimi ve işlem hızı çok yüksek olmaktadır. Bu avantajları sayesinde geleneksel aracı kurumlara üstünlük sağlamış ve mevcut finansal araçlar ile işlem yapan işletmeleri, iş modellerinde değişiklik yapmaya zorlamaktadır. (Karaoğlan, Arar, Bilgin, 2018).

2008 yılında kullanımına başlanan Bitcoin adlı kripto para ekonomik etkinliklere dâhil olunca mevcut klasik ödeme araçları ve sistemleri üzerinde sorgular başlamıştır. Kripto para sistemi internet ve teknolojik yenilikler üzerine kurulduğu için; toplumun çoğunluğu tarafından bilgi ve iletişim teknolojileri kullanımı yetersizliği nedeniyle piyasaya çıktığı ilk yıllarda sınırlı sayıdaki kişilerce kullanılabilmiştir. İlk kripto para olan bitcoin'in çıktığı ilk yıl olan 2008 yılından 2018 yılına kadarki 10 yıllık süreçte; kripto paranın mevcut paralar içerisindeki kullanım oranı ancak %2 olmuştur. (Fanusie, Robinson, 2018).

Çoğu zaman dijital para, sanal para ve kripto para kavramları birbiri ile karıştırıldığı için bu yeni para sistemlerini inceleyelim.

2.1. Dijital Para

Sadece sanal ortamda kullanılabilen dijital para, geleneksel olan madeni ya da kâğıt para gibi bir değeri, karşılığı ve satın alma gücü olan ama fiziksel olarak ele alınması mümkün olmayan bir para birimidir. Dijital para internet ortamında sanal olarak kullanılır, ama yine de bir merkezi otoritenin yetkisi dâhilindedir. Yani merkezi yapıdadır ve merkez bankası paralarının karşılığıdır. İnternet üzerinden bilgisayar, tablet ve akıllı telefonlar gibi teknolojik cihazlar aracılığıyla alınabilirler. Bu dijital paralara sanal para, elektronik para, elektronik döviz, dijital döviz gibi isimler de verilmektedir.

Dijital parayı internetten alarak sanal ortamda kullanabilir, biriktirebilir, başkalarına transfer edilebilir ya da alışverişlerimizde kullanabiliriz. Kullanım amacı daha çok sanal ortamdaki güvenlik amaçlıdır. Tüm paramızı bulundurduğumuz gerçek banka hesap numaralarımız ve gerçek kredi kartı bilgilerimiz yerine internet üzerinden yapacağımız tüm alışveriş ve satın almalarda gerçek bilgilerimiz yerine oluşturduğumuz dijital paramızı kullanabilir ya da başkasına transfer edebiliriz. Dijital paranın farklı türleri vardır. Bazı dijital paralar, elektronik ortamda biriktirilerek pek çok alışverişte kullanılabilirken, bazıları yalnızca belirli platformlarda kullanılabilir. Örneğin; yalnızca belirli bir oyun ya da sosyal medya platformunda kullanılabilen dijital para çeşitleri vardır.

Dijital para kavramı, İnternet ortamında geçerliliği olan para birimlerinin tamamını kapsar. Kripto para, dijital para kavramının bir alt başlığı olarak değerlendirilebilir. Tüm kripto para çeşitleri, dijital ortamda yaratıldığı ve kullanıldığı için dijital para olarak değerlendirilir; ancak tüm dijital para birimleri kripto para değildir.



2.2. Kripto Para

Kripto para dijital para biriminin bir alt dalı olarak adlandırılan ve fiziksel olarak var olmayan paralara verilen isimdir. Kripto paralar; en genel tanımı ile bir bilgisayar ve internet bağlantısı ile kullanılabilen, paranın tüm fonksiyonlarını üzerinde taşıyan, geleneksel para biçimleri ile kıyaslandığında ciddi avantajları olan, merkezi olmayan ve belli bir algoritma tarafından oluşturulup idare edilen dijital para birimleridir. Şifreli bir şekilde oluşturulduğu için kripto paralara (cryptocurrency) şifreli para veya bazı kaynaklarda da sanal para denilmektedir. Sadece dijital ortamda belli bir şifre ile yaratılan bu paranın alınıp satılması ve işlem görmesi de dijital ortamda gerçekleşir. Piyasaya çıkan ilk kripto para Bitcoin'dir ve 2008 yılında oluşturulmuştur. Bitcoin ismini dijital ölçü birimi olan İngilizce bit kelimesinden ve Türkçesi madeni para olan İngilizce coin kelimelerinin birleşiminden almıştır.

İlk olması ve piyasadaki kullanım büyüklüğü nedeniyle kripto para olarak ilk akla gelen para birimi Bitcoin'dir. Bitcoin dışında, farklı piyasaları ve uygulama biçimlerini hedef alan, Bitcoin dışında piyasaya çıkan ve halen piyasaya çıkmaya devam eden birçok farklı kripto paralarda mevcuttur (Dizkırıncı ve Gökgöz, 2018). Bitcoin Cash, Ethereum, Litecoin, Ripple, Iota, Dash, Neo, Nem, Monero, Zcash gibi yüzlerce olan bu dijital para birimlerine ise Altcoin veya bitcoin alternatifleri ismi verilir.

Piyasadaki mevcut para birimleri gibi basılı olmayan ve fiziksel olarak dokunamadığımız; sadece dijital ortamdaki bilgisayar sistemlerinde kayıtlı bulunan bu alternatif kripto paraların değerlerini piyasadaki veya borsadaki alıcılar tarafından oluşturulan arz ve talep belirler. Bu paralar herhangi bir ülkenin ekonomik durumundan etkilenmemekle birlikte bu paraların bulunduğu hesaplara hiçbir şekilde el konulamamakta, hesaplar dondurulamamaktadır (Eğilmez, 2017a). Bitcoin sisteminde; ödemelerde herhangi bir gecikme, banka transferlerinde sıkıntı yaşama, EFT/Havale/SWIFT masrafları ile hesap işletim ve kredi kartı ücretleri söz konusu değildir (Çarkacıoğlu, 2016).

Bitcoin; 2008 yılı sonlarında Satoshi Nakamoto (pseudonym – mahlas) olarak bilinen bir kişi ya da grup tarafından, "Bitcoin: Kişiden kişiye elektronik nakit sistemi" adlı makale ile Bitcoin'in teorik altyapısı yayınlanmış, 2009 yılında ise Bitcoin programına (sonraları adı Bitcoin Core olmuştur) işlerlik kazandırılmıştır (Nakamoto, 2008). Bitcoin'in Satoshi Nakamoto tarafından icat edildiği söylenmekte ise de mucidin gerçek isminin bu olup olmadığı bilinmemektedir (Eğilmez, 2013). Bitcoin, finansal sistemin başarısızlığına ve dolar, Euro gibi güçlü rezerv para birimlerine alternatif olarak ortaya çıkmıştır (Dilek, 2018).

Satoshi Nakamoto tarafından oluşturulan Bitcoin'in sembolü ₿ dir ve kısaltılarak BTC ile gösterilir. En küçük para birimi "Satoshi"dir ve 1 Bitcoin 100 Milyon Satoshi değerindedir. Kripto para sahipleri, internette kendilerine ait sanal cüzdan hesabı oluşturarak Bitcoin'lerini ve altcoinlerini Bitcoin Cüzdanları (Bitcoin Wallet) denilen bu hesapta saklayabilir. Kişiler kimlik bilgilerini açıklama zorunluluğu olmadan dijital paralarını kullanabilirler. Dijital ortamda kripto paralar ile ödeme işlemleri yapıldığında, bu ödemenin ne zaman yapıldığı, kime yapıldığı ve ne kadar ödeme yapıldığı izlenememektedir (Eğilmez, 2013; Eğilmez, 2017b).

Bitcoin oluşturma işlemine madencilik (mining/hardware mining) ismi verilir. Madencilik çok güçlü bilgisayar donanımları ve özel olarak hazırlanan bilgisayar yazılımı ile sistem üzerinden sunulan karmaşık matematik problemlerini programlarla çözdürerek bitcoin oluştururlar. Bitcoin oluşturan kişilere madenciler (miner) ismi verilir Madenciler bitcoin oluşturma karşılığında belirli miktarda bitcoin kazanırlar. Madenciler eşler arası bağlantı veya bilgisayardan-bilgisayara bağlantı ismi verilen teknolojiyi kullanarak (Peer-to-Peer-P2P) bitcoin oluştururlar.

Kripto para sistemleri ekonomi, kriptografi ve bilgisayar bilimlerinin birleşmesinden oluşan disiplinler arası iş birliğinin ürünüdür. Bitcoin benzeri kripto paraları oluşturanlar ve bu para birimine sahip olanlar bu paraları ile işlem yaparken herhangi bir devlet otoritesine vergi ve benzeri



ödeme yapmazlar. Klasik ödeme sisteminde olduğu; gibi bu paraları kabul eden şirketlerde mal ve hizmet satın almada kullanabilirler.

22 Mayıs 2010 tarihinde Bitcoin ile ilk satın alma işlemi yapılmıştır. Bitcoin kullanarak Laszlo Hanyecz isimli bir kullanıcı Dominos Pizzadan 2 adet pizza satın almıştır. Bir başka Bitcoin kullanıcısı bu pizzayı 10.000 Bitcoin değerinde alıp Laszlo'nun adresine göndermiştir. Tarihteki ilk Bitcoin'in takas aracı olarak kullanıldığı 22 Mayıs dünyanın pek çok yerinde “Laszlo'nun Pizza Günü” olarak kutlanmaktadır (Çarkacıoğlu, 2016).

2010 yılındaki alım işleminden sonra Bitcoin Market, MtGox gibi Bitcoin alım ve satımlarının gerçekleştirilebileceği Bitcoin borsaları oluşturulmuştur. Günümüzde Tesla, Microsoft, PayPal, DELL, Amazon, Subway gibi kuruluşlar tarafından Bitcoin ödeme aracı olarak kullanılmaktadır (Koçoğlu ve ark, 2016; Dilek, 2018). 2010 yılından itibaren Bitcoin'in ödeme aracı olarak kullanılmasının iş dünyasında giderek artan oranda kabul görmeye başlamasıyla birlikte Bitcoin borsaları aracılığıyla oluşan Bitcoin'in diğer para birimleri karşısındaki değeri de çok büyük artış göstermiştir (Dulupçu ve ark, 2017). Kripto para birimleri özellikle gelişmiş ülkelerde pek çok amaçla kullanılarak yaygınlaşmıştır. Yaygınlaşmadan da öteye giderek ilk olarak Kanada olmak üzere pekçok ülkede Bitcoin ATM'leri faaliyete geçmiştir. Türkiye'de ilk İstanbul Atatürk Havalimanı'nda Bitcoin ATM'si kurulmuş (Aslantaş, 2016) ve halen 9'u İstanbul'da 1 tanesi İzmirde olan 10 bitcoin ATM'si vardır.

Kripto para kullanımında; işlemlerde maliyet düşüklüğü sağlaması, vergi ödemediği işlem yapılabilmesine imkân tanınması, paranın sahibinin kim olduğunun belli olmaması, denetimsiz olması ve saklamadaki yüksek güvenirliliği kullanıcılar tarafından avantaj olarak görülmektedir. Bu avantajlarının yanında finans alanında bazı sorunları da beraberinde getirdiği aşikârdır. En önemlisi sorun güvenlik sorunudur. Kripto para kazancı vergilendirilemediği için vergi kaçırma nedeniyle devletlerin vergi kaybı olmaktadır. Kripto paralar kara para aklamada kullanılması nedeniyle yasal ve etik sorunları olmaktadır. Gerek avantajları gerekse dezavantajlarına rağmen kripto paraların kullanımı her geçen gün daha da artmaktadır.

Tablo 1. Dijital Para ile Kripto Paranın Farkları

Dijital Para	Kripto Para
Dijital paraların arkasında merkezi yapılar vardır. Dijital paralar, bu parayı piyasaya sokan ve geliştiren kurumlar tarafından denetlenir.	Kripto paralar, merkezi bir otorite tarafından kontrol edilmez.
Dijital paralar ile yapılan işlemler gizli tutulamaz, geleneksel para transferinde olduğu gibi kimlik bilgileri paylaşılır.	Kripto para işlemlerinde ise kimlik bilgilerine ve bu bilgilerin banka ya da resmî kurumlar gibi merkezi yapılarla paylaşılmasına gerek yoktur.
Dijital paralar hakkında ise birçok ülkede yasal düzenleme yapılmıştır ve yapılmaya devam edilir.	Kripto paralar, tüm dünyada son dönemde popüler olan ve çok az ülke tarafından tanınan ya da düzenleme yapılan para birimleridir.
Dijital paralar ile yapılan işlemler ise siber tehditlere karşı çok daha savunmasızdır	Kripto para piyasasının temelini oluşturan blok zinciri (blockchain) sistemi, teknolojik altyapısı sebebiyle oldukça güvenilir ve şeffaftır.
Dijital para birimlerinin değerleri özellikle istikrarlı ekonomilerde çok değişmez.	Ancak, kripto paraların değerleri daha değişkendir. Çünkü kripto para piyasası henüz tam olarak gelişmiş bir piyasa değildir ve resmi otorite tarafından desteklenmez. Kripto para ise ülkelerin ekonomilerinden ve dünya olaylarından etkilenerek değerini belirler.
Dijital paralar ile yapılan tüm işlemler dijital ortamda kayıt altına alındığı için şeffaf bir sistemdir.	Kripto paralar ile yapılan tüm işlemler dijital ortamda denetimsiz ve kayıt altına alınmadığı için şeffaf bir sistem değildir.

Kripto para birimlerinin yasalarla düzenlenmiş varlık olmamaları nedeniyle kullanıcılar açısından birçok riski bulunmaktadır. Ama tüm bu risklere rağmen, geleneksel ödeme aralarına göre sağladıkları faydalarla kripto para birimleri giderek daha çok tercih edilmektedirler. Kripto paralar yeni nesil yatırım aracı olarak görülmektedir.



2.3. Blok Zinciri (Blockchain) teknolojisi

Sayıları 1500’ü geçen kripto paraların temelini blok zinciri teknolojisi oluşturmaktadır. Blockchain kelimesi yeni bir teknolojiye verilen isimdir ve İngilizce block ve chain kelimelerinin bir araya getirilmesi ile oluşturulmuştur. Kelimenin Türkçe çevirisi ise blok zinciri olarak yapılmaktadır. Teknoloji ise wikipedi’da (web adresi) şu şekilde tanımlanmaktadır: ‘‘Teknoloji mal veya hizmetlerin üretiminde veya buna yönelik amaçların gerçekleştirilmesinde kullanılan beceriler, yöntemler, işlemler, tekniklerin derlenmesi veya bilimsel araştırmalardır.’’ Tanımdan da anlaşıldığı üzere teknoloji, sonucunda mal veya hizmet üretimi olan bir süreçte verilen isimdir. Blok zinciri teknolojisi en basit tanımı ile aslında bir tür veri tutma sistemidir. Bu veri tutma sistemi olası güvenlik açıklarına karşı mevcut veri tutma sistemlerinden çok daha güvenlidir. Blok zinciri teknolojisi dileyen herkesin kolayca erişebileceği bir ağ üzerinde şifrelenen verilerin yönetilmesini sağlar. Blok zinciri teknolojisi şeffaflığını ise, verilerin merkezi değil dağınık bir şekilde tutulmasına borçludur (Krause ve diğer., 2016).

Tablo 2. Blok zinciri ve eski veri tutma yöntemlerinin karşılaştırılması

	Blok Zincir Teknolojisi	Geleneksel Veri Tutma Yöntemi
Verilerin İşleniş Şekli	Veriler belli bir düzene göre işlenir.	Veriler belli bir düzene göre işlenir.
Veri Tutma Yöntemi	Dağıtık	Merkezi
Verilerin Kopya Sayısı	Milyonlarca	Oldukça az ya da sınırlı
Verilerin Güvenliği	Yüksek	Düşük
Verileri İşleyen Otoriteler	Milyonlarca farklı bilgisayar	Belirli bir devlet, kurum, kuruluş, kurul ya da şahıs
Verilerin Manüpülasyonu / Değiştirilebilirliği	İmkânsıza yakın	Yüksek
Şeffaflık	Yüksek	Düşük
Maliyet	Düşük	Yüksek

Blok zinciri teknolojisi birçok bilim insanı tarafından muhasebe defterine benzetilerek anlatılmaktadır. Blok zinciri teknolojisinin bir muhasebe defterinden farkı ise; verilerin tek bir şirket, tek bir kişi ya da bir grup tarafından değil milyonlarca farklı noktadaki bilgisayarlardan madencilik yöntemi ile işlenmesidir.

Geleneksel yöntemde bir şirkette aynı muhasebe defterinden bir asıl bir de yedek olmak üzere iki tane bulunurken, Blok zinciri teknolojisi ile verilerin milyonlarca kopyası milyonlarca farklı noktadaki bilgisayarlarda bulunmasıdır. Ayrıca Blok zinciri teknolojisi çok daha yüksek güvenli, düşük maliyetli ve şeffaftır.

İnternet dünyamızı nasıl kısa bir sürede değiştirdi ise blok zinciri teknolojisi de çok daha kısa sürede çok daha köklü dönüşümlerin nedeni olmuş ve olacaktır. Bu genç teknoloji daha şimdiden hayatımızın birçok alanında kullanılmaya başlanmıştır. Blok zinciri teknolojisi, kripto para piyasaları dolayısıyla ilk başlarda kendini daha çok finans sektöründe göstermesine rağmen kullanım alanı birçok sektöre uygulanabilir niteliktedir. Finans sektöründen sonra başta oyun, turizm ve rekreasyon sektörü olmak üzere birçok sektör yavaş yavaş evrimleşmekte ve blok zinciri teknolojisine entegre olmaya çalışmaktadır.

Peki blok zinciri teknolojisi neden devrimsel bir teknolojidir? Bu soruya verilecek yanıtlar oldukça radikal olabilmektedir. Ancak unutulmamalıdır ki bugünün radikal düşünceleri çoğu zaman yarının gerçekleri olmaktadır. Blok zinciri teknolojisi devrimsel bir teknolojidir; çünkü özel ya da kamu olsun merkezi yapıya sahip aracı kurumların doğrulama hizmetini (authentication-kimlik doğrulama) çok daha güvenli, çok daha hızlı ve çok daha ucuza yapabilmektedir. Bu bağlamda önümüzdeki birkaç on yıl, blok zinciri teknolojisi ile özel ve kamu çeşitli kuruluşların dönüşümüne şahitlik edeceğimiz yıllar olabileceği potansiyelini taşımaktadır (Coşkun, 1997).



3. Rekreasyon, Dijital Rekreasyon ve Rekreasyon İşletmeleri

İngilizce karşılığı recreation olan rekreasyon kelimesi, sözlük anlamında yeniden yaratma, canlandırma, yeniden yaratılmış şey, eğlence, dinlenme ve boş zamanı hoşça vakit geçirme yolu anlamını ifade etmektedir (Hazar, 2009). İnsanların çalışma saatleri dışındaki zamanları boş zamandır. Herhangi bir zorunluluk ya da yükümlülük olmaksızın değerlendirilme potansiyeli olan zamanlar boş zaman kavramı içine girer (Shivers ve DeLisle, 1997).

Rekreasyon için pek çok tanımlama yapılmıştır. Rekreasyon, insanların boş zamanlarında kendi istekleriyle özgürce gerçekleştirdikleri (Ateca, Rosa ve Toscano, 2008) buldukları mekânlardan uzaklaşma, dinlenme, hava değişimi, gezme görme, beraber olma, heyecan duyma, farklı deneyimler kazanma gibi değişik amaçlarla ev dışında veya içinde açık veya kapalı alanlarda, aktif ya da pasif şekilde katıldıkları bu etkinlikleri ifade eden bir kavramdır (Hacıoğlu, Gökdeniz ve Dinç, 2003).

Sanayileşme sürecinde hızlı ve monoton üretim temposu insanların verimliliği üzerinde olumsuz etki yaratmış ve bunun karşılığında boş zamanların rekreasyonel yönden değerlendirilmesi ile üretim potansiyelinin artırılması hedeflenmiştir (Şahin vd. 2001). Teknolojik gelişmeyle birlikte insanların eğitim ve gelir düzeylerinin yükselip çalışma saatlerinin azalması ile insanların serbest zamanları artmış ve boş zamanlarında öğrenmek, keşfetmek ve araştırmak için çeşitli etkinliklere talepleri artmıştır. Rekreasyonel etkinlikler insanlara fizyolojik, psikolojik ve sosyal açıdan olumlu etkileri bulunmakta, kişinin kendine olan güveni ve saygısını arttırmakta (Kurar, Baltacı, 2014) ve insanların sosyalleşmesi, toplumsallaşma, fizyolojik ve psikolojik tabanlı rahatsızlıkların önlenmesi ve tedavi edilmesi gibi pek çok yararları bulunmaktadır.

Rekreasyon alanında boş zaman tüketicisi tarafından yapılan aktiviteleri sekiz başlık altında incelemek mümkündür. Bunlar; öğrenme temelli aktiviteler, rekreasyon temelli aktiviteler, seyirci olarak katılımın gerçekleştiği aktiviteler, seyahat temelli aktiviteler, konaklama temelli aktiviteler, yeme-içme temelli aktiviteler, alışveriş temelli ve ev temelli aktivitelerdir. (Gürel, Eröz, 2017). Aşağıda Şekil 1’de boş zaman ve rekreasyon aktivitelerinin detayları verilmiştir.

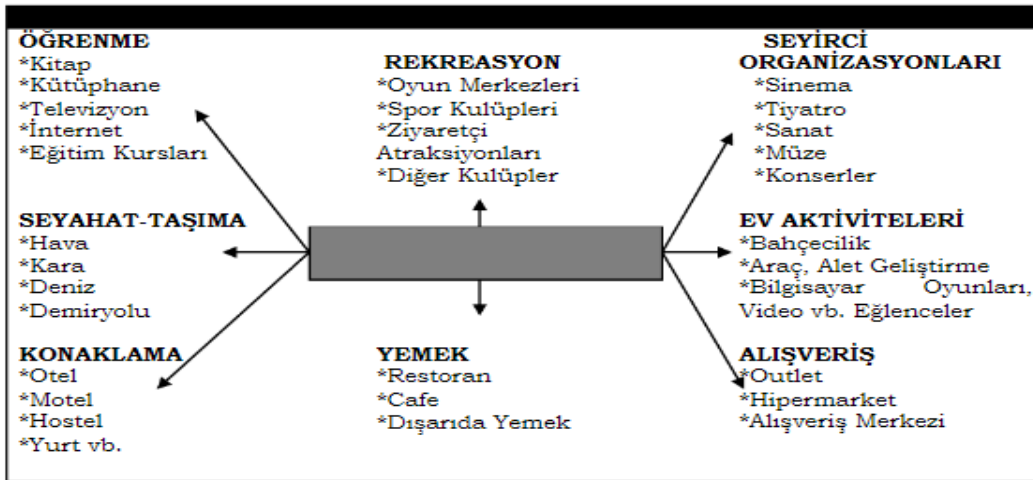

Şekil 1. Kategorilerine Göre Boş Zaman ve Rekreasyon Aktivite Türleri (Kaynak:Argan, 2007)

Günümüzde robotlaşma, nesnelerin interneti, yapay zeka, sensörler, bilişsel teknolojiler, nanoteknoloji, internet hizmetleri, kuantum bilişim, giyilebilir teknolojiler, artırılmış gerçeklik, akıllı sinyalizasyon, akıllı robotlar, büyük veri, 3D ve akıllı şebekeler gibi yeni nesil teknolojiler (Bahar vd., 2019) hayatın bir parçası olmuştur. Bu teknolojiler; rekreasyon alanında da yeni tanımlar, değişimler ve dönüşümler yaratmıştır. İlk olarak rekreasyon kavramına dijital rekreasyon, sanal rekreasyon, online rekreasyon gibi kavramlar eklenmiştir. Aylan & Aylan’a (2020) göre **dijital rekreasyon**; insanların boş zamanlarını değerlendirmek, dinlenmek, bedenlen ve zihnen yenilenmek, kaliteli zaman geçirmek vb. amaçlarla, sanal ortamlarda veya gerçek ortamlarla sanal uygulamaların



birleştirildiği platformlarda, bilgisayarlar, akıllı cep telefonları, VR-BOX 3D gözlükler, oyun konsolları, joystickler vb. teknolojik araçlarla yapılan spor yapma, yarışma, seyahat etme veya gezi, kitap okuma, oyun oynama, sanatsal etkinlikler, vb. aktiviteler dijital rekreasyon kapsamında değerlendirilebilir. Kozak ve Özkeröglü (2018) çalışmalarında, sanal turizm uygulaması olarak açıklanan kavramın “sanal rekreasyon” veya “dijital rekreasyon” kapsamında ele alınmasında fayda olduğunu belirtmiştir.

Rekreasyonel aktivitelerde yaşanan teknolojik değişimler ile fiziksel alanlarda gerçekleştirilen birçok rekreatif faaliyet e-oyun gibi sanal ortamlarda veya fiziksel ile sanalın iç içe geçtiği ortamlarda gerçekleştirilmeye başlanmıştır. En yaygın olarak bilinen dijital rekreatif faaliyetler; sanal müze, mağara, şelale, kanyon, dağ, doğal güzellikler, resim sergisi, antik kent, kale, kule, kilise, cami vb. mekânlara yapılan sanal geziler ve bisiklete binmek, yürümek, tenis, golf oynamak, kuş gözlemciliği, boks, fitness gibi birçok dijital rekreatif faaliyetlerdir. İleride katılacak olan yeni sektörler bu organizasyon çeşitliliğinin gün geçtikçe daha da artmasına katkı sağlayacaktır.

Gelişen teknoloji ve dijital rekreasyon kavramı ile yapılan rekreatif etkinliklerin yapılma yöntemleri değişmiş ve bunları yaparken rekreasyon işletmelerine yapılan ödeme yöntemleri de dönüşüm geçirmiştir. Rekreatif faaliyetler için ödeme yöntemleri klasik ödeme yöntemlerinden dijital para ve kripto paralara doğru evrilmiştir. 22 Mayıs 2010 tarihinde gerçekleşen kripto para ile pizza satın alımı gibi. Günümüzde özellikle Internet üzerinden yapılan ödemelerin çoğu dijital paralarla olmaktadır. E-oyun, e-ticaret gibi sektörlerde pek çok uygulama üzerinden dijital paralar kazanılmakta ve bunlar harcanabilmektedir.. Pek çok kurum dijital parayı ödeme aracı olarak kullanmakta, kripto para ATM’lerinin kullanımı yaygınlaşmaktadır.

4. Sonuç ve Değerlendirme

Satoshi Nakamoto tarafından 2008 yılında duyurulan Bitcoin ile başlayan paranın ve finansal sistemlerin dijital dönüşüm süreci çok hızlı bir şekilde devam etmektedir. Bu alanda 14 yılda muazzam gelişmeler ve dönüşümler yaşanmış, geleceğe yönelik radikal fikirler ve iddialar ortaya atılmıştır. Konu gerek akademik platformlarda gerekse basında sık sık gündeme gelmektedir. Bu dijital dönüşüm sürecinin nasıl bir gelişim sergileyeceğini kestirmek tabii ki mümkün değildir; ancak yine de bazı tutarlı çıkarımlar yapılabilir. Bu çıkarımların ilki ve belki de en çok tartışılanı, en radikal olanı küresel çapta her ulus, şirket ve her tek birey tarafından kabul görecektir tek bir para biriminin oluşmaya başlayacağı yönündedir. Şuan var olan tüm kripto paralar arasında evrensel para birimi olma şansı en yüksek olan elbette Bitcoin’dir. Nayib Bukele önderliğindeki El Salvador ülkesi bu konuda ilk adımı atan ülke olarak Bitcoin’i ikinci ulusal para birimi olarak kabul etmiştir. El Salvador küçük ve etki sahası dar bir ülke olabilir ancak zamanla El Salvador’un bu adımını başka ülkelerinde takip etmesi tüm dünya ülkelerini evrensel para birimini kabul etmeye mecbur bırakabilir. Tabii ki böyle bir durumun söz konusu olması bile dünyadaki ekonomik ve siyasi olmak üzere pek çok dengeyi değiştirecek boyutta dönüşümlere neden olma potansiyelini bünyesinde barındırmaktadır.

Şu an için en radikal seçenek olan evrensel para seçeneği gerçekleşmeyecek olsa da ya da bu seçeneğin gerçekleşmesi çokça zaman alacak olsa da yakın gelecekte değişmesi muhtemel durumların başında üçüncü tarafların onay hizmetinin artık işlevini yitiriyor olması gelmektedir. Para transferi, Rekreasyon işletmelerinin yürüttüğü hizmetlerin hepsi blok zinciri teknolojisi ve kripto paralar sayesinde üçüncü tarafların onayına gerek kalmadan üstelik çok daha ucuza ve çok daha güvenli bir şekilde yapabilmektedirler. Bu durum merkezi yapıların güçlerini önemli ölçüde sarsmaktadır ve merkezi olmayan yapıların gelişimine neden olmaktadır.

Dijital para ve kripto para sisteminin sağladığı avantajlarının yanında dezavantajları da bulunmaktadır. Kripto para sistemleri bilgisayarda açık kaynaklı yazılımlarda olduğu, bunların



bilgisayarlara kolayca yüklenebildiği ve merkezi olmayan ağ üzerinde olduğu için; bu para sistemine yönelik hacker saldırıları, oluşturulan sahte bitcoin hesap ve cüzdanları ve karşılaşılan sahte alıcı ve satıcılar gibi sahteci girişimler olabilir. Bu tür girişimler için bireylerin korunması ve yasal takibi mümkün olmayacağından güvenlik açığı oluşmaktadır. Bu sistemde altyapının yetersiz oluşu, belirlenmiş bir yasal çerçevenin olmaması, hukuksal, muhasebeleştirme ve vergilendirme gibi birçok alanda yapılması gereken hususlar vardır ve bunlar kripto paraların kullanılmasının ve yaygınlaşmasının önündeki engellerdir. Bu sorunların giderilmesi gerekmektedir. Sorunların giderilmesi ile bu piyasalar daha kontrol edilebilir hale gelecek ve bu para sistemleri de farklı merkezi yapılara kavuşabilecektir.

Bitcoin ile başlayan kripto para sistemi içerisinde ilerleyen yıllarda başka para sistemleri de dahil olacaktır. Geliştirilecek bu yeni para sistemleri bu alanda son halka olmayacak, değişen ve gelişen teknoloji ile yeni şartlar için para sistemleri de sürekli bir değişim ve dönüşüm içerisinde olacaktır. Bu kaçınılmazdır. Belki de; çıkan alternatif ödeme yöntemleri şimdikilerden daha gelişmiş, daha farklı, daha güçlü, daha etkili ve daha güvenli olacaktır. Bu durum da finans, bankacılık ve para sistemleri baştan sona değişebilir. Ama mevcut haliyle; şu anda kısmen kripto para hesabı açan tüketicilerin çoğu da alışveriş yerine sadece gelecek beklentileri ve yatırım amaçlı bu tür bir yönelme içine girmektedirler (Jonker, 2018:7).

Bu dijital dönüşüm sürecinin nasıl bir seyir izleyeceğine tahmin yürütülmesi belki mümkün değildir; ama kesin olan şudur ki geri dönüşümün mümkün olmadığı bir dönüşüm süreci içerisinde olduğumuzdur. Bu süreçte rüzgârı arkasına alanların yeni dünya sisteminde daha iyi konumlarda olacağı kesindir.

KAYNAKÇA

- Alpago, H. (2016), *Dün, Bugün ve Gelecekte Bilim Ekonomi ve Sosyal Yaşam*, Pamiray Yayınları, İstanbul
- Alpago, H. (2018). Bitcoin'den Selfcoine'e Kripto Para. *IBAD*, 2018; 3(2):411-428
- Argan, M. (2007). *Eğlence Pazarlaması*. Ankara: Detay Yayıncılık, s:36.
- Aristoteles, (1975). *Politika*. (Çev. Mete Tuncay). İstanbul: Remzi Kitabevi Yayınları.
- Aslantaş Ateş, B., (2016) “Kripto Para Birimleri, Bitcoin ve Muhasebesi”, Çankırı Karatekin Üniversitesi Sosyal Bilimler Enstitüsü Dergisi, 7(1): 349-366.
- Ateca, A. V., Serrano-del, R. R. and Toscano, E. V. (2008). The leisure experience. *The Journal of Socio-Economics*, 37(1): 64-78.
- Aylan, F.K. & Aylan, S. (2020). Sanal Gerçeklik ve Artırılmış Gerçeklik Uygulamalarının Rekreatif Faaliyetlere Yansıması: Dijital Rekreasyon. *Türk Turizm Araştırmaları Dergisi*, 4(3), 2746-2760.
- Bahar, M., Yüzbaşıoğlu, N. Topsakal ve Y. (2019). Akıllı Turizm ve Süper Akıllı Turist Kavramları Işığında Geleceğin Turizm Rehberliğine Bakış. *Journal of Travel and Tourism Research*, 14: 72-93
- Coşkun, İ. (1997). *Modern Devletin Doğuşu*, İstanbul: Der Yayınları
- Çarkacıoğlu, A. (2016) “Kripto-Para Bitcoi”, Sermaye Piyasası Kurulu Araştırma Raporu, Ankara.
- Dilek, Ş. (2018) “Blockchain Teknolojisi ve Bitcoin”, Şubat, Sayı: 231, Ankara: SETA Yayınları.
- Dizkırıcı, A.S. ve Gökgez, A. (2018) “Kripto Para Birimleri ve Türkiye’de Bitcoin Muhasebesi”, *Journal of Accounting, Finance and Auditing Studies*, 4/2: ss: 92-105
- Dulupçu, M.A., Yiyit, M. ve Genç, A.G. (2017) “Dijital Ekonominin Yükselen Yüzü: Bitcoin’in Değeri İle Bilinirliği Arasındaki İlişkinin Analizi” Süleyman Demirel Üniversitesi İktisadi ve İdari Bilimler Fakültesi Dergisi, 22(Kayfor Özel Sayısı): 2241-2258
- Fanusie, Y. J., Robinson, T. (2018), Bitcoin Laundering: An Analysis of Illicit Flows into Digital Currency Services, January 12, 2018, FDD’s Center on Sanctions and Illicit Finance (CSIF)
- Fidan, M., Dilek, S., Esev, A. (2019) Dünden Bugüne Paranın Tarihi ve Türkiye’de Kâğıt Para Kullanımı. *Dünden Bugüne Paranın Tarihi ve Türkiye’de Kâğıt Para Kullanımı*, ss:5,6
- Gürel, G. & Eröz, S. (2017). Rekreasyon İşletmecilerinin Yetkinliklerinin ve Sektöre Yönelik Düşüncelerinin Belirlenmesi Üzerine Nitel Bir Araştırma, *Route Educational and Social Science Journal Volume 4(6)*, October 2017, ss. 12-33.



- Hacıoğlu N., Gökdeniz A. ve Dinç Y. (2003). Boş zaman&rekreasyon yönetimi örnek animasyon uygulamaları. Ankara: Detay Yayıncılık.
- Harari, Y.N. (2015) *Hayvanlardan Tanrılara Sapiens*. (Çev. E. Genç). İstanbul: Kolektif Kitap (Özgün Çalışma 2012), ss:180
- Hazar A(2009). Rekreasyon ve Animasyon, Detay Yayıncılık, Ankara.
- Jonker, N. (2018), What drives bitcoin adoption by retailers?, Working Paper No. 585, February 2018, De Nederlandsche Bank NV, Amsterdam
- Kamalak, M. (1980). Para ve Para Sistemleri. *Atatürk Üniversitesi İktisadi ve İdari Bilimler Dergisi*, 4 (3-4), s. 71-97.
- Karaoğlu, S., Arar, T., Bilgin O.,(2018). Türkiye’de Kripto Para Farkındalığı ve Kripto Para Kabul Eden İşletmelerin Motivasyonları, *İşletme ve İktisat Çalışmaları Dergisi*, Cilt 6, Sayı 2, 2018, ss.15-28
- Koçoğlu, Ş. Çevik, Y.E. ve Tanrıöven, C.,(2016). “Bitcoin Piyasalarının Etkinliği, Likiditesi ve Oynaklığı”, *Journal of Business Research Turk*, 8(2): 77-97.
- Kozak, A. M. ve Özkeroğlu, Ö., (2018). Turizm ve Rekreasyon Kavramları: Sanal Bakış ile Değerlendirme. II. Uluslararası Sürdürülebilir Turizm Kongresi, 20-22 September 2018, Gümüşhane, Türkiye.
- Krause, E.G., Velamuri, V.K., Burghardt, T., Nack, D., Schmidt, M. ve Treder, T.M., (2016). Blockchain Technology and the Financial Services Market State of the Art Analysis, *HHL*, s:6.
- Kurar, İ., Baltacı, F.,(2014). Halkın Boş Zaman Değerlendirme Alışkanlıkları: Alanya Örneği, *International Journal of Science Culture and Sport* August 2014 : Special Issue 2, sayfa 39
- Nakamoto, S., (2008). Bitcoin: A peer-to-peer electronic cash system.
- Ponting, C., (2000) *Dünyanın Yeşil Tarihi*. (Çev. Ayşe Başçı). İstanbul: Sabancı Üniversitesi Yayınları, 27-33
- Shivers, Jay S. and L. J. Delisle, (1997). *The Story of Leisure*, Australia.
- Şahin M., Koç S., Yılmaz A., (2003). *Beden Eğitimi ve Sporda Sponsorluk*, s. 171, Gaziantep Spor Kulübü Yayınları No:2, Nobel Yayın, Ankara.
- Üzer, B., (2017). *Sanal Para Birimleri, Uzmanlık Yeterlik Tezi*, Türkiye Cumhuriyet Merkez Bankası Ödeme Sistemleri Genel Müdürlüğü Ankara, Eylül 2017 , s.19
- Web adresi:**
<https://tr.wikipedia.org/wiki/Teknoloji> 30.12.2021 tarihinde alınmıştır.
- Eğilmez, M. (2013) “Kendime Yazılar: Bitcoin”,
<http://www.mahfiegilmez.com/2013/11/Bitcoin.html>, (01.10.2018).
- Eğilmez, M. (2017a) “Kendime Yazılar: Kripto Paralar, Bitcoin ve Blockchain”,
<http://www.mahfiegilmez.com/2017/11/kripto-paralar-Bitcoin-ve-blockchain.html>, (01.10.2018).
- Eğilmez, M., (2017b). *Kendime Yazılar: Bitcoin Nasıl Alınıp Satılır?*
<http://www.mahfiegilmez.com/2017/12/Bitcoin-nasl-alnp-satlr.html>. 9 Aralık 2017 (Erişim Tarihi: 01.10.2018).



BALLARDAKİ TAKLİT VE TAĞŞIŞ İLE İLGİLİ YASAL DÜZENLEMELER

Recep SIRALI

Halime PEHLİVANOĞLU

Faculty of Veterinary Medicine, Department of Animal Science, Tekirdağ Namık Kemal University (NKÜ), Tekirdağ, Turkey

Orcid No: 0000-0001-9702-617

Faculty of Veterinary Medicine, Department of Food Hygiene and Technology, Tekirdağ Namık Kemal University (NKÜ), Tekirdağ, Turkey

Orcid No: 0000-0003-3138-9568

Özet

Bal; bitki nektarlarının, bitkilerin canlı kısımlarının salgılarının veya bitkilerin canlı kısımları üzerinde yaşayan bitki emici böceklerin salgılarının, bal arısı tarafından toplandıktan sonra kendine özgü maddelerle birleştirerek değişikliğe uğrattığı, su içeriğini düşürdüğü ve petekte depolayarak olgunlaştırdığı, doğası gereği kristalleşebilen doğal bir üründür. Ayrıca besin değeri, lezzeti ve kendine özgü aromasından dolayı tarih boyunca önemli bir gıda maddesi olarak kabul edilmiştir. Bal oldukça karmaşık yapısından dolayı hileye açık ve hilenin belirlenmesi oldukça zor olan doğal bir gıdadır. Bu nedenle piyasada saf ve doğal balların yanında hileli ballar da bulunmaktadır. Tüketici bazındaki esas sorun doğal ballar ile hileli balların birbirinden ayırt edilmesinin analiz yapılmadan mümkün olmayışdır. Tüketicilerin denetimsiz olarak piyasaya sürülen bu hileli balları yıllardır ekonomik nedenlerle tüketme eğilimi ile karşı karşıya bırakılmaları, gerçek balı ayırt edemeyen bir tüketici topluluğunu da oluşturmuştur. Dolayısıyla sahte ballar doğal bal, doğal ballar ise sahte bal olarak değerlendirilebilmekte ve satın alınabilmektedir. Bu bağlamda baldaki sahtecilik, tüketici güvenini sarsarak pazarın gelişimini olumsuz yönde etkilemektedir. Oysa Türk Gıda Kodeksi Bal Tebliği'ne göre, bala gıda katkı maddeleri de dahil olmak üzere dışarıdan hiçbir maddenin yanı sıra hiçbir aroma ve aroma özelliği taşıyan gıda bileşenleri katılmasına izin verilmemektedir. Bu çalışma ile ülkemizde bal üretimi ile ilgili, haksız rekabet oluşturan ve çoğunlukla ekonomik kazanç sağlamak amacıyla yapılan taklit ve tağşış olarak isimlendirilen birtakım usulsüzlüklere ve geçmişten günümüze alınan bazı yasal düzenlemelere ait bilgi verilmesi amaçlanmıştır.

Anahtar Kelimeler: Bal, taklit, tağşış, yasal düzenleme

LEGAL REGULATIONS REGARDING IMITATION AND ADULTERATION IN HONEY

Abstract

Honey is a natural product that can be crystallized by nature, where plant nectars, the secretions of living parts of plants or the secretions of plant-sucking insects living on the living parts of plants are collected by the honey bee and then modified by combining them with their own specific substances, lowering the water content and maturing by storing them in the honeycomb. It has also been accepted as an important food item throughout history due to its nutritional value, taste and unique flavor. Honey is a natural food that is open to adulteration due to its complex structure and it is very difficult to detect adulteration. For this reason, besides pure and natural honeys, there are also adulterated honeys in the market. The main problem on the basis of consumers is that it is not possible to



distinguish between natural honey and fraudulent honey without analysis. The fact that consumers have been faced with the tendency to consume these adulterated honeys, which have been released unsupervised, for economic reasons for years has also created a consumer community that cannot distinguish real honey. Therefore, fake honey can be considered as natural honey and natural honey can be considered and purchased as fake honey. In this context, counterfeiting in honey negatively affects the development of the market by shaking consumer confidence. However, according to the Turkish Food Codex Honey Communiqué, it is not allowed to add any external substances, including food additives, as well as food ingredients with any flavor and aroma properties. With this study, it is aimed to give information about some irregularities, which are called imitation and adulteration, which create unfair competition in our country, and which are mostly made for the purpose of economic gain, and some legal regulations taken from the past to the present.

Keywords: Honey, imitation, adulteration, legal regulation

GİRİŞ

Bal; besin değeri, lezzeti ve kendine özgü aromasından dolayı tarih boyunca önemli bir gıda maddesi olarak kabul edilmiş en eski doğal üründür. Dünya’da çok yaygın olarak yetiştiriciliği yapılan bal arıları (*Apis mellifera* L.) buldukları bölgenin florasına bağlı olarak fiziksel ve kimyasal özellikleri birbirinden farklı ballar üretmektedir. Hasat dönemi ve hasat sırasında uygulanan işlemler, ısıtma ve depolama koşulları gibi pek çok faktör balın kalite özelliklerini etkilemektedir (Özdemir ve ark., 2000).

Türk Gıda Kodeksine göre bal; bitki nektarlarının, bitkilerin canlı kısımlarının salgılarının veya bitkilerin canlı kısımları üzerinde yaşayan bitki emici böceklerin salgılarının, bal arısı tarafından toplandıktan sonra kendine özgü maddelerle birleştirilerek değişikliğe uğrattığı, su içeriğini düşürdüğü ve petekte depolayarak olgunlaştırdığı, doğası gereği kristalleşebilen doğal ürünü ifade eder. Bal kaynağına göre çiçek ve salgı balı olmak üzere 2 çeşit, üretim ve/veya pazara sunulmuş şekline göre petekli bal, doğal petekli bal, karakovan balı, süzme bal, petekli süzme bal, sızma bal, pres balı ve filtre edilmiş bal olmak üzere 8 çeşittir (Anonim, 2020a).

Son yıllarda, tüketicilerin gıda ve içerikleri hakkında daha bilinçli hale gelmesi; bal gibi sağlıklı, doğal ve besleyici gıdaların kullanımına olan ilgiyi arttırmıştır. (Belščak ve ark., 2009). Balın değerli ve talep edilen bir gıda maddesi olması ve insan beslenmesindeki faydaları, arıcılığın öneminin artmasına ve yaygınlaşmasına neden olmaktadır (Kaftanoğlu, 1987).

Günümüzde gıda üretiminin her alanında olduğu gibi bal üretiminde de; her türlü hile veya aldatmaya yönelik eylemlerin olduğu bilinmektedir (Albayrak, 2018). Bal oldukça karmaşık yapısından dolayı hileye açık ve hilenin belirlenmesi oldukça zor olan bir gıdadır. Bu nedenle piyasada saf ve doğal balların yanında hileli ballar da bulunmaktadır. Tüketicilerin denetimsiz olarak piyasaya sürülen bu hileli balları yıllardır ekonomik nedenlerle tüketme eğilimi ile karşı karşıya bırakılmaları, gerçek balı ayırt edemeyen bir tüketici topluluğunu da oluşturmuştur. Dolayısıyla sahte ballar doğal bal, doğal ballar ise sahte bal olarak değerlendirilebilmekte ve satın alınabilmektedir (Kumova, 2019). Bu bağlamda baldaki sahtecilik, tüketici güvenini sarsarak pazarın gelişimini olumsuz yönde etkilemektedir (Cabañero ve ark., 2006).

Tüketici bazında ki esas sorun doğal bal ile arılara şekerden yaptırılan bal benzeri ürünün birbirinden ayırt edilmesinin güçlüğüdür (Ateş, 1994). Arıcılıkta koloninin yavru geliştirme dönemlerinde ve koloninin açlık durumlarında şeker şurubu ile beslenmesi mümkün olabilir, fakat nektar salgılanma dönemlerinde şeker şurubu verilerek yüksek bal üretiminin amaçlanması kabul edilebilir bir durum değildir (Alataş ve ark., 1996). Tüketici tarafından balların sahte olup olmadığı, renk, koku, tad ve



akışkanlık gibi genel duyuşsal özelliklerine bakılarak anlaşılammaktadır (Damarlı ve Coşkun, 2015). Bu nedenle baldaki taklit ve tağşışın belirlenmesi için bir dizi karışık analize ihtiyaç duyulmaktadır.

Çok miktarda üretilen sahte ve suni ballar nedeniyle, gerçek bal üreticisi ürününü satamamakta, piyasadaki genel bal kalitesi düşmekte ve tüketici kesim de kandırılmış olmaktadır (Çarkçioğlu, 2009). Bu tür olumsuzlukların önüne geçmek için Tarım ve Orman Bakanlığı da gıda güvenirliliği konusunda gerekli çalışmaları yaparak insan sağlığına uygun olmayan balların üretimini, işlenmesini ve piyasaya arz edilmesini önlemeye çalışmaktadır.

Bu makalede, ülkemizde bal üretimi ile ilgili, haksız rekabet oluşturan ve çoğunlukla ekonomik kazanç sağlamak amacıyla yapılan taklit ve tağşış olarak isimlendirilen birtakım usulsüzlüklere ve geçmişten günümüze alınan bazı yasal düzenlemelere ait bilgi verilmesi amaçlanmıştır.

BALDAKİ TAKLİT VE TAĞŞİŞ UYGULAMALARI

5996 sayılı Veteriner Hizmetleri, Bitki Sağlığı, Gıda ve Yem Kanununda “taklit”, “ürünlerin, şekil, bileşim ve nitelikleri itibarıyla yapısında bulunmayan özelliklere sahip gibi veya başka bir ürünün aynısıymış gibi gösterme” şeklinde; “tağşış” ise “ürünlere temel özelliğini veren öğelerin ve besin değerlerinin tamamının veya bir bölümünün mevzuata aykırı olarak çıkarılmasını veya miktarının değiştirilmesini veya aynı değeri taşımayan başka bir maddenin, o madde yerine aynı maddeymiş gibi katılması” olarak tanımlanmaktadır (Anonim, 2010).

Balın üretimi esnasında ya da üretimden sonra yapılan çeşitli hileler ve ısıl işlemler balın doğal yapısını bozmakta ve gıda değerini önemli ölçüde azaltmaktadır. Bal hem fiyatı hem de üretim ve tüketim miktarları dikkate alındığında taklit ve tağşış edilen gıda maddeleri arasında en kolay hile yapılabilen fakat analizi ve tespiti çok zor olan bir üründür. Taklit ve tağşışın başlıca nedeni; çevresel olumsuzluklar sonucu doğal florada oluşan zararlardan dolayı üreticilerin yeteri kadar bal üretememesi, balın ekonomik değerinin yüksek olması, zahmetsiz ve kolay para kazanma isteğidir (Karkacier ve ark., 2000).

Gerçek bal; bal arıları tarafından çeşitli nektarlar kullanılarak üretilen ve üretimden önce ya da sonra herhangi bir katkı maddesi ve şeker şurubu ilave edilmeyen, olgunlaştırma işlemi depolandıkları petek gözlerinde yapılan, gerek işleme gerekse depolama esnasında 45 °C'nin üzerinde ısıl işleme tabi tutulmayan, böylece tüketiciye ulaşana dek genel bileşim özelliklerini koruyan doğal tatlı bir gıda olmasına karşın, taklit bal üretiminde arının hiçbir katkısı olmadan tamamen kimyasal yollar ile değişik şeker şurupları içerisine polen, renk maddesi ve bal aroması maddeleri katılarak bala benzer tat-lezzet ve görünüm sağlanmaktadır (Anonim, 2021; Bölükbaşı, 2010).

Tağşışli bal üretiminde; arının ya sadece yüksek mısır şurubu, invert şeker şurubu, sakaroz şurubu ve glikoz şurubu gibi şuruplar verilerek beslenmesi ya da hem çiçek nektarlarından alması hem de şeker şurupları ile beslenmesi, balın içerisine şeker şurupları katılarak bal miktarının artırılması, bala farklı özellikteki balların karıştırılması, düşük rutubet içeriğine sahip ballara su ilave edilmesi gibi farklı işlemler uygulanmaktadır. Böylece balın doğal früktoz-glikoz-sakaroz profili taklit edilebilmekte ve bunu tespit etmek oldukça zor olmaktadır (Anonim, 2021; Bölükbaşı, 2010).

Ayrıca diğer gıda maddelerinde olduğu gibi bal da sağlığı tehdit edebilecek zararlı bir madde içeriyorsa bunun tağşışli olduğu kabul edilmektedir (Anonim, 2020b; Türkmen ve Ataseven, 2020).

GEÇMİŞTEN GÜNÜMÜZE BALLA İLGİLİ YASAL DÜZENLEMELER

Arıcılık, tüm toplumlarda önemli bir tarımsal faaliyet olarak kabul edilmiş ve bu konuda çeşitli kanun ve düzenlemeler yapılmıştır (Güney, 2015). Böylece gelişmiş ülkelerin 1996 yılında başlattığı çalışma ve düzenlemelere yeni boyutlar getirilmesi konusu hızlandırılmıştır. Uluslararası bal standardı, Avrupa Gıda Kodeksi Bal Yönergesi, Avrupa Birliği ve Kanada bal standardı hatta



Almanya Avrupa Birliğinden ayrı olarak farklı yeni düzenlemeleri yürürlüğe koymuştur (Kumova, 2019).

Günümüzde her gıda maddesinde olduğu gibi balın da üretiminden satışına kadar uyulması gereken bazı standart ve yönetmeliklerin yanı sıra işin vicdani boyutu ve etik kuralları bulunmaktadır (Sıralı, 2013). Hileli bal üretiminin önüne geçebilmek için ülkemizde de denetimler yapılmakta ve yasal düzenlemeler getirilmektedir (Çil İplikçioğlu, 2013). Tüm yasal düzenlemelerin amacı; tüketicinin gerçek bal tüketmesini sağlamak ve sağlığını korumak, ona saygı duymak ve değer vermek, olarak ifade edilmiştir (Sıralı, 2013).

Türkiye’de gıda güvenliğine ilişkin ilk yasa 1930 yılında çıkarılan 1580 sayılı “Belediye Yasası”dır. Bu yasanın 15. maddesi gıda üretim, depolama ve satış yerlerinin denetimini belediye sınırları içinde, belediye görevleri arasında saymıştır. Bu alanda ilk kapsamlı yasa ise Belediye Yasasından kısa bir süre sonra, yine 1930 yılında çıkarılmış olan 1593 sayılı “Umumi Hıfzıssıhha Yasası”dır (Anonim, 2020c).

Ülkemizde bu konu ile ilgili olarak 1593 sayılı Umumi Hıfzıssıhha Kanunu gereği, önce 1942 yılında Sağlık ve Sosyal Yardım Bakanlığı tarafından hazırlanan “Gıda Nizamnamesi” daha sonra da 1952 yılında “Gıda Maddeleri Tüzüğü” yürürlüğe konmuştur. Gıda Maddeleri Tüzüğü kapsamının on beşinci bölümünde ballarla ilgili detaylara değinilmiştir. Söz konusu tüzük balların taşıyacağı niteliklere ve bunların hangi koşullarda bozulmuş, taklit veya tağşiş edilmiş sayılacağına dair hükümleri de içermektedir (Anonim, 1972).

Tarım Orman ve Köyişleri Bakanlığı tarafından 1990 yılında Arıcılık Yönetmeliği yürürlüğe konmuştur. 3161 sayılı Tarım Orman ve Köyişleri Bakanlığının Teşkilat ve Görevleri hakkındaki kanunun 33. Maddesine istinaden hazırlanan bu yönetmeliğin amacı; arıcılığı geliştirmek araştırma, ıslah, hastalık ve zararlılarla mücadele, üretim, yayım, gezginci arıcılık, ballı bitkiler, zirai mücadele önlemleri petek ve bal standardizasyonu hizmetlerini düzenlemektir (Anonim, 1990a).

Türk Standartları Enstitüsü tarafından 1990 yılında TS 3036 Bal standardı oluşturulmuştur. Bu standart; balın tarifini, balın çeşitleri ve özelliklerini, balın sınıflandırılmasını, bal örneği alma, bal analizleri ile balların piyasaya sunumu konularını içermektedir (Anonim, 1990b). Ancak bu standart günün koşullarına cevap vermediği için daha sonra yeniden revizyona alınmıştır (Ateş, 1994). Bal standardının en son revizyonu 2014 yılında yapılmıştır (Anonim, 2014).

Ülkemizde gıda hizmetlerine yönelik en temel ve yapısal değişiklikler getiren düzenleme 560 sayılı “Gıdaların Üretimi Tüketimi ve Denetlenmesine Dair Kanun Hükmünde Kararname” ile 28.6.1995 tarihinde yürürlüğe girmiştir. Bu kararname ile gıda hizmetlerindeki dağınıklık ve kargaşanın önlenmesi amaçlanmıştır. Ayrıca Avrupa Birliği ile Gümrük Birliği Anlaşmasının imzalanması sonucu, ülkemiz gıda mevzuatının AB mevzuatı ile uyumlu hale getirilmesinde, söz konusu kararname önemli bir başlangıç oluşturmuştur (Anonim, 2020c). Ayrıca 16 Kasım 1997 yılında Türk Gıda Kodeksi ile gıda sanayinde HACCP uygulamaları zorunlu hale getirilmiştir (Pehlivanoğlu, 2020).

Günümüzde bal konusunda her ülkenin kendine göre bazı farklı uygulamaları ve istisnaları olabilmektedir. Ülkemizde ise Avrupa Birliğine uyum çerçevesi kapsamında günümüz koşullarına cevap verebilecek bal tebliği oluşturulurken Codex Alimentarius Bal Standardı ve Avrupa Birliği Bal Direktifleri temel alınarak (Güney, 2015), Avrupa Birliğine uyum çerçevesinde hazırlanmıştır (Ayaz, 2015).

27.05.2004 tarihinde 5179 sayılı “Gıdaların Üretimi, Tüketimi ve Denetlenmesine Dair Kanun Hükmünde Kararnamenin Değiştirilerek Kabulü Hakkında Kanun” kabul edilmiş ve gıda güvenliğinin temini bu kanunun doğrudan amacı olmuştur. Ayrıca, gıda güvenliğini temin için bu kanun çerçevesinde bir dizi yönetmelik ve tebliğler yayınlanmıştır. Bu yasada gıda güvenliğinin



sağlanması hususunda sorumluluk gıda işletmelerine verilmekle beraber, Bakanlığın belirleyeceği usul ve esaslar çerçevesinde yerel otoriteler, belediyeler, Sağlık Bakanlığının ilgili birimleri gıda güvenliğine yönelik denetimleri yapmakla görevlendirilmişlerdir (Anonim, 2020c).

Resmi Gazete’de 17.12.2005 tarihinde yayımlanarak yürürlüğü giren Türk Gıda Kodeksi Bal Tebliğinde balın tanımı detaylı bir şekilde tarif edilmiş, balın tekniğine uygun ve hijyenik şekilde üretimi ve satışa hazırlanması, depolanması, nakledilmesi ve pazarlanması aşamalarında bulundurması gereken özellikleri belirtilmiştir (Anonim, 2005).

Nitekim ülkemizde Avrupa Birliğine uyum çerçevesi kapsamında, Avrupa standartları göz önüne alınarak hazırlanan Türk Gıda Kodeksi Bal tebliğinde gerçekleştirilen yeni düzenlemeler ve standartlar, üreticilerin kaliteli ve standartlara uygun bal üretmesinin yanı sıra bal tüketicilerinin sağlığının korunması açısından da son derece önemli yaptırımlar ortaya koymuştur (Kumova, 2019).

Türk Gıda Kodeksi Bal Tebliğinde, balda olması gereken ve balın taşınması gereken tüm özellikler belirtilmiş; bala üretim esnasında veya sonrasında doğal bileşiminde bulunmayan hiçbir şeyin ilave edilemeyeceği, insan sağlığını tehdit eden hiçbir patojen, pestisit, veteriner ilaçları ile ve Türk Gıda Kodeksi Şeker Tebliğinde yer alan şekerleri içermeyeceği, kaçınılmaz kayıplar dışında baldan polen ve bala özgü bileşenlerin uzaklaştırılmayacağı ifade edilmiştir (Anonim, 2020a).

Avrupa Birliği bal kodeksinde arıcılıkta onaylı ilaçların dışında, hiçbir kimyasal maddenin kullanılmasına izin verilmemiş ve antibiyotik kullanımına da yasak getirilmiştir. Dünyada ve ülkemizde geliştirilen tüm bu yeni düzenlemelerde, balda bulunmasına izin verilen maddeler, kimyasal maddelerin maksimum kalıntı limitleri, bal için geçerli ölçütler ve bal üretiminde kullanılmaması gereken maddeler de yer almaktadır (Kumova, 2019).

Türk Gıda Kodeksi Bal Tebliği, içeriği ile daha önce bal konusunda hazırlanmış olan Gıda Maddeleri Tüzüğü ile Türk Standartları Enstitüsü TS 3036 Bal Standartlarının günümüz koşullarına göre daha da geliştirilmiş yasal düzenlemesi olup, arıcılığımız ve arıcılarımız için nitelikli bal üretimi, muhafazası ve tüketime sunum aşamasında uyulması gereken çok önemli bir rehber ve başvuru kaynağı niteliği taşımaktadır.

Belirtilen tüzük, standart ve tebliğlerde bal terimine yalnız ticari ve tüketici anlamında değil, aynı zamanda balın nerede ve hangi bitkiden üretildiği, içeriği, depolama durumu, çeşitli özellikleri, korunması vs. konularında da açıklık getirilmektedir (Sıralı, 2010).

Zaten bal ile ilgili geçmişten günümüze oluşturulan Gıda Nizamnamesi, Gıda Maddeleri Tüzüğü, TSE 3036 Bal Standardı, Türk Gıda Kodeksi Bal Tebliğinin ortak amacı halkımızın gerçek bal tüketmesini hedeflemesidir (Sıralı, 2013). Gerek tüketici ve gerekse üretici açısından oldukça önemli kuralları, kalite, hijyen ve gıda güvenliğini içeren bu yönetmeliklerde balın üretilmesi, depolanması ve pazarlanmasına ilişkin gerekli koşullar detaylarıyla açıklanmış durumdadır (Sıralı, 2019).

Bal üretimi ile uğraşan arıcılarımızın yanı sıra bal ile ilgili faaliyet gösteren gıda işletmeleri de Türk Gıda Kodeksi Bal Tebliği ile ilgili hükümlerin yanında yatay gıda kodeksi hükümlerine uymak zorundadır (Ayaz, 2015). Bal, bal ile temas eden madde ve malzeme ile ilgili faaliyet gösteren işletmeciler, kendi faaliyet alanının her aşamasında tebliğde belirtilen şartları sağlamak ve bunu doğrulamakla yükümlüdür (Anonim, 2020c).

Tarım ve Köyişleri Bakanlığı tarafından 2009 yılında “Bal Sektörü İçin İyi Hijyen Uygulamaları Rehberi” yürürlüğe konmuştur. Bu rehber; Tarım ve Köyişleri Bakanlığı desteği ile Gıda Dernekleri Federasyonunca Türk Gıda Kodeksi Bal Tebliği, Kodeks Alimentarius Bal Standardı, ve Avrupa Birliği Komisyonu Bal Tebliğine uygun olarak hazırlanmıştır. Söz konusu rehberde, mevzuata uygun kaliteli ve güvenli bal üretiminin sağlanması ve balla ilgili sektöre yardımcı olunması, işyerlerinin teknik ve hijyenik normlarının geliştirilmesi amaçlanmıştır (Anonim, 2009).



Bal Sektörü İçin İyi Hijyen Uygulamaları Rehberinin amacı, gıda güvenilirliği açısından tüketicinin korunmasını sağlamak için balın üretiminden son tüketiciye arzına kadar uyulması gereken gıda hijyenine ilişkin genel kuralları belirlemektir. Söz konusu rehber, bal üreticisinin birincil üretim aşaması dahil üretim, işleme ve dağıtımın tüm aşamalarında bal hijyenini sağlamak üzere uyması gereken genel hijyen kuralları ile sorumluluklarına ilişkin usul ve esasları kapsamaktadır (Anonim, 2020c).

AB tarafından uyum sağlanamadığı için “yetki karmaşası ve tutarsızlıklar olduğu, tüm kontrol yetkilerinin merkezi otorite ve buna bağlı yerel otoriteler tarafından gerçekleştirilmediği, Bakanlığın bu yönde yeniden yapılandırılması gerektiği” yönüyle eleştirilen 5179 Sayılı Kanunun yerine geçmek üzere, Tarım ve Köyişleri Bakanlığınca 13.06.2010 tarih ve 27610 sayılı Resmi Gazete’de “5996 sayılı Veteriner Hizmetleri, Bitki Sağlığı, Gıda ve Yem Kanunu” yayımlanmıştır 13.12.2010 tarihi itibarıyla yürürlüğe giren 5996 Sayılı Kanun, tarladan/çiftlikten sofraya/çatala gıda güvenliği sistemini baştan sona değiştirmiştir (Anonim, 2020c).

Gıda Güvenliği, tüketime sunulacak gıda maddelerinin fiziksel, kimyasal, biyolojik özellikleriyle insan tüketimine uygun olması, her türlü zarar ve zararlıların bertaraf edilmesi için; gıda maddelerinin hazırlanması, işlenmesi, ambalajlanması, depolanması, nakliyesi ve dağıtımını işlemlerinde alınan tedbirlerin bütünü olarak tanımlanabilir (Pehlivanoglu, 2020).

Birleşmiş Milletler Gıda ve Tarım Örgütü (FAO) ise gıda güvenliğini, fiziksel, kimyasal ve biyolojik özellikleri itibarıyla üreticiden tüketiciye kadar geçen süreçte tüketime uygun, sağlıklı ve besin değerini kaybetmemiş, bozulmamış gıda maddesi olarak tanımlamaktadır (Karabal, 2019).

Çiftlikten sofraya ve risk esasına dayalı gıda güvenliği sistemi 2010 yılında çıkan 5996 sayılı kanunla ortaya konulmuş olup, bu kapsamda bakanlığın il ve ilçelerde çok sayıda teknik personel görevlendirdiği bilinmektedir. Bu elemanlar, birincil üretimden son üretime kadar olan zincirde ürünün güvenilir olarak son tüketici olan topluma ulaşmasında hizmet vermektedir. Bu, gıda güvenliği felsefesinin çiftlikten sofraya olan uzantısındaki en önemli aşamasını oluşturmaktadır (Anonim, 2012a). 5996 Sayılı Kanun, gıda ve yeme ilişkin ürünlerin üretim aşamasından tüketiciye sunulmasına kadar geçen tüm süreci, Gıda, Tarım ve Hayvancılık Bakanlığının kontrolüne vermiştir (Anonim, 2020c).

Kuralların ve standartların tek başına gıda güvenliğini sağlayamadığı, etik değer yargılarını geliştirmeden gıda güvenliğinin, tam olarak gerçekleştirilemeyeceği herkes tarafından kabul edilmiştir. Bu sebeple tüm toplumları ilgilendiren gıda etiği ile ilgili birçok çalışma mevcuttur. Bu bağlamda Food Ethics Council’in faaliyetleri 1998 yılında İngiltere’de başlamıştır (Tansey, 2019). Ülkemizde ise şirketlerin yazılı kültürünün temelinde, iş etiğinin yer alması için 2010 yılında “Etik ve İtibar Derneği” (TEİD) kurulmuş olup, aynı dernek tarafından “Etik ve Uyum Yöneticisi Mesleğinin Standartları” hazırlanarak, T.C. Mesleki Yeterlilik Kurumunca onaylanmış ve 09/06/2018 tarihli Resmi Gazete’de yayımlanmıştır. Yine Ülkemizde 2016 yılında tarım ve gıdanın kapsadığı tüm faaliyetlerde ortaya çıkabilecek etik sorunlar ile ilgili, ilk sivil toplum örgütü olan Tarım ve Gıda Etiği Derneği (TARGETDER) kurulmuştur. Ayrıca TEİD’ tarafından 300’den fazla global kurumca kabul gören “TRACE certificate”ın Türkiye temsilciliğini TEİD üstlenmiştir (Anonim, 2016; Anonim, 2020d).

Gıda işletmecisi ürettiği, işlediği, ithal ettiği, satışını veya dağıtımını yaptığı bir ürünün, gıda ve yem güvenilirliği şartlarına uymadığını değerlendirmesi veya buna ilişkin makul gerekçelerinin olması durumunda, söz konusu ürünü kendi kontrolünden çıktığı aşamadan başlamak üzere, toplanması için gerekli işlemleri derhal başlatmak ve konu ile ilgili Bakanlığı bilgilendirmek zorundadır. Gıda ve yem işletmecisi, ürünün toplanması gerektiğinde, toplanma nedeni hakkında tüketiciyi veya kullanıcıyı doğru ve etkin olarak bilgilendirmek ve gerekli hâllerde, insan sağlığını



korumaya yönelik alınacak tedbirlerin yeterli olmaması durumunda, tüketiciye veya kullanıcıya ürünün iadesi için çağrıda bulunmak zorundadır (Anonim, 2020c).

Dünyada ve ülkemizde oluşturulan bu yeni düzenlemelerde, balda bulunmasına izin verilen maddeler ile kimyasal maddelerin maksimum kalıntı limitleri, bal için geçerli ölçütler ve kullanılmaması gereken maddeler ve zorlayıcı yaptırımlar yer almaktadır. Bu uygulamalar iç ve dış piyasada bal tüketicilerinin sağlığının korunması açısından son derece önemli ve olması gereken yaptırımlardır (Kumova, 2019).

Yönetmelik gereği balın iyi üretim uygulamaları çerçevesinde üretilmesi, bileşiminde insan sağlığı açısından tehlikeye yol açabilecek maddelerin bulunmaması ve duyuşsal özelliklerinde istenmeyen deęişikliklerin olmaması gerekmektedir (Ayaz, 2015).

İlgili bakanlıklar tarafından yayımlanan genelgelerde, tüketicinin aldanmasına sebep olabilecek şekil ve özellikte olan gıda maddelerinin satışının yasak olduęu belirtilmektedir (Sıralı, 2016). Taklit ve taęşişlere açık bir ürün olan bala hiçbir katkı maddesinin katılamayacağı ve balın insan sağlığını tehdit eden düzeyde hiçbir madde içerebileceğı (Çarkçioęlu, 2009), geçmişte Gıda Maddeleri Tüzüğü ve Türk Standartları TS 3036 Bal'ın yanı sıra yeni oluşturulan Türk Gıda Kodeksi Bal Tebliğinde açıkça belirtilmiş durumdadır (Sıralı, 2016; Anonim 2020a).

Türk Gıda Kodeksi Bal tebliğine göre, bala gıda katkı maddeleri de dahil olmak üzere dışarıdan hiçbir maddenin yanı sıra (Anonim, 2005), hiçbir aroma ve aroma özelliğı taşıyan gıda bileşenleri katılmasına izin verilmemektedir (Anonim, 2020a). Balı üretme, taşıma ve depolama süresince uyulması gereken şartların yanı sıra ambalajlayan veya ithal eden işletmelerin 1 Mart 2015 tarihinden itibaren tüketiciye sunulmak üzere ambalajlı olarak piyasaya arz ettikleri ballar için sisteme uymaları gerekmektedir (Ayaz, 2015).

178/2002 sayılı tüzük çerçevesinde Türkiye'deki gıdalarda yapılan taklit ve taęşişle ilgili konular Avrupa Birlięi'nde "Gıda Dolandırıcılığı" başlığı altında toplanmakta olup (Anonim, 2019), gıda dolandırıcılığı da Gıda Standartları Ajansı (FSA) tarafından "tüketiciyi aldatma niyetiyle ve finansal kazanç için kasıtlı olarak gıdayı piyasaya arz etmek" veya dięer bir ifadeyle ekonomik olarak çıkar sağlamak amacıyla gıdaya yapılan yasa dışı müdahale olarak tanımlanmaktadır. Müdahaleler, gıdanın deęerini olduęundan yüksek göstermek veya ucuz benzerlerinin ilavesiyle maliyetini düşürmek şeklinde olabilmektedir (Hong ve Lee, 2017). Gıda dolandırıcılığı; taęşiş ve taklit faaliyetlerini de içeren ancak bunun ötesinde gıda ürünleri ile ilgili vergi kaçırma, kaçakçılık gibi faaliyetleri de kapsayan daha geniş bir kavram olarak karşımıza çıkmaktadır (Manning ve Soon, 2016).

Gıda konusunda yasal dayanak olan 5996 sayılı Kanununun 24. madde 4. fıkrasında gıdada taklit ve taęşiş yapılamaz hükmü yer almaktadır. 5996 sayılı Kanun'un 40. Madde 1. bendi gereği ise taklit ve taęşiş yapan gıda işletmelerine idarî para cezası verilmekte, taklit ve taęşiş edilmiş ürünlere el konulmaktadır. El konulan ürünler piyasaya arz dışında deęerlendirilemiyorsa imha edilmektedir. Arz amacı dışında deęerlendirilebilen ürünler ise mülkiyeti kamuya geçirilerek, ekonomiye kazandırılmaktadır. Ayrıca, 5996 sayılı kanunun 40. madde a bendi gereği laboratuvar analizleri neticesinde insan sağlığını tehlikeye düşürecek şekilde bozulmuş, deęiştirilmiş gıdaları üreten veya piyasaya arz edenler hakkında kamu sağlığına karşı suçlar kapsamında Cumhuriyet Savcılığı'na suç duyurusunda bulunularak ürünler tüm masraflar sorumlusu tarafından karşılanmak üzere piyasadan toplatılarak imha edilmektedir (Türkmen ve Ataseven, 2020).

Ülkemizde gıda kontrol ve denetim faaliyetlerinde Bakanlık bünyesinde çok sayıda gıda kontrol görevlisi bulunmaktadır (Anonim, 2020b; Türkmen ve Ataseven, 2020). Özellikle internet, radyo, televizyon vb. medya organları aracılığı ile satışa sunulan ve genel olarak taklit ve taęşiş yapılan ürünlerin kontrolüne yönelik RTÜK, Gümrük ve Ticaret Bakanlığı, Telekomünikasyon İletişim Başkanlığı, Sağlık Bakanlığı gibi kurumlarla işbirliğı yapılmaktadır (Ayaz, 2015).



2012 yılında çıkan bir yasa ile laboratuvar analizi sonucu taklit ve tağşiş yaptığı kesinleşen firmalar ve ürünleri Bakanlığın resmi internet sitesinden kamuoyu ile paylaşılmaktadır (Anonim, 2020b; Türkmen ve Ataseven, 2020).

Bal reklamları ile ilgili şikâyetlerin artması üzerine konuya ilişkin kanun düzenlenmesini gerçekleştiren Gümrük ve Ticaret Bakanlığı da RTÜK aracılığıyla farklı ticari isimlerle bal satan bazı firmaların reklamlarının durdurulmasını sağlamıştır (Anonim, 2012b).

Bakanlıklar arası işbirliği kapsamında bir sürü bal firmasına tüketiciyi kandırmaya yönelik reklamlarından dolayı reklam kurulu tarafından yaptırım uygulanmış, bazı bal firmalarının isimleri sahte bal pazarlamasından dolayı Sanayi ve Ticaret Bakanlığı tarafından basın yayın organlarında teşhir edilmiş, bazılarında da Tarım Bakanlığı tarafından yüklü miktarda para cezaları verilmiş ve suçlular adli makamlara sevk edilmiştir (Sıralı, 2019).

Piyasada sahte ve hileli balların yoğun olarak varlığından sonra ortaya çıkan olumsuz gidişatın ardından Tarım ve Orman Bakanlığının tüketicilerimizin korunmasına yönelik yaptığı müspet açıklamalar, altı özellikle çizilmesi gereken “ürün toplama, para cezası, savcılığa suç duyurusunda bulunma ve yönetmeliklere uymayan firmaları kamuoyunda teşhir cezalarının uygulanmasına devam edilmesi” yönündedir (Sıralı, 2013).

Arıcılık konusunda söz sahibi kurum olan Tarım ve Orman Bakanlığının piyasaya sahte bal sürenlerle mücadeledeki kararlığı, bal üretimi ve tüketimine ilişkin her kesimden insanın sahteciliğin önlenmesi ve gıda güvenliği adına olumlu bir gelişme olarak kabul görmüştür (Sıralı, 2013).

SONUÇ

Bal içerdiği bileşenler nedeni ile besleyici değeri yüksek sağlıklı bir gıda maddesidir. Bu nedenle geçmişten günümüze, tüm bireyler tarafından sevilerek tercih edilen, tüketilen ve ekonomik değeri yüksek bir üründür. Balın sağlıklı ve ekonomik değerinin yüksek olması nedeni ile gıda güvenliğinin sağlanması, ürün kalitesinin standartlaştırılması, verimliliğin artırılması, merdiven altı üreticilerin kontrol altına alınarak haksız rekabetin önlenmesi, üreticinin korunması ve bilinçlendirilmesi, iyi tarım ve iyi üretim uygulamalarının teşvik edilmesi gerekmektedir.

Ayrıca ülkemizde ve uluslararası ticarete ekonomik katkısının korunması için de taklit ve tağşiş uygulamalarının önlenmesi gerekmektedir. Bu konuda başta Bakanlığımız olmak üzere üniversitelerimize, araştırma enstitülerine, meslek odalarına, sivil toplum kuruluşlarına ve toplumdaki her bireye görev düşmektedir.

Sonuç olarak; balın üretiminden satışına kadar uyulması gereken bir takım standart, yönetmelik ve diğer yasal düzenlemelerin hiçe sayılması ülkemizin bu alandaki imajını zedeleyeceği ve bal dış satımını zora sokacağı da akıldan çıkarılmamalıdır.

KAYNAKLAR

Alataş, İ., Bulakeri, N., Öztürk, İ., 1996. Aşırı şeker şurubu ile arı beslemenin balın bileşimi üzerine etkileri. T.C. Tarım ve Köyişleri Bakanlığı, Tarımsal Araştırmalar Genel Müdürlüğü Yayın No: 4, Menemen, İzmir.

Albayrak, H., 2018. Sağlıklı gıda. [www.gunebakis.com.tr/ saglikli gıda makale, 8513.html](http://www.gunebakis.com.tr/saglikli_gida_makale_8513.html). [10.12.2018]

Anonim, 1972. Gıda Maddeleri Tüzüğü'nün Yürürlüğe Konması. Resmi Gazete. Sayı 14182. Ankara.

Anonim, 1990a. Arıcılık yönetmeliği. Tarım Orman ve Köyişleri Bakanlığı. 14 sayfa. Ankara.



- Anonim, 1990b. Türk standartları TSE 3036 bal. 20 sayfa. Ankara.
- Anonim, 2005. Türk gıda kodeksi bal tebliği (2005/49). Resmi Gazete. Sayı 26026. Ankara.
- Anonim, 2009. Bal sektörü için iyi hijyen uygulamaları rehberi. Tarım ve Köyişleri Bakanlığı Rehber No 1. 40 sayfa. Ankara.
- Anonim, 2010. 5996 sayılı veteriner hizmetleri, bitki sağlığı, gıda ve yem kanunu. <https://www.mevzuat.gov.tr/mevzuat?MevzuatNo=5996&MevzuatTur=1&MevzuatTertip=5>. [07.03.2020]
- Anonim, 2012a. Herkes sorumlu davranmalı. 04.12.2012 Tarihli Milli Gazete. Sayfa 4. İstanbul.
- Anonim, 2012b. TV'den bal satışına sıkı takip. Türktarım. Sayı 203, sayfa 65. Ankara.
- Anonim, 2014. Türk standartları TS 3036 bal. Bakanlıklar/Ankara.
- Anonim, 2016. https://www.bugday.org/portal/haber_detay.php?hid=7915 [21.10.2020]
- Anonim, 2019. Bal şifadır. Türkiye Arı Yetiştiricileri Merkez Birliği. <http://www.tab.org.tr/bal-sifadir.html>, [03.03.2021]
- Anonim, 2020a. Türk gıda kodeksi bal tebliği (2020/7). Resmi Gazete. Sayı 31107. Ankara.
- Anonim, 2020b. Taklit ve tağşiş ürünleri listesi. <https://www.tarimorman.gov.tr/>. [08.03.2021]
- Anonim, 2020c. Gıda mevzuatı ve gıda güvenliği. <https://www.tesk.org.tr/view/yazdir/mevzuatyazdir.php?Guid=80b81e70-1a76-11ea-9eaf-000c29b32a85> [07.09.2020]
- Anonim, 2020d. Etik ve itibar derneği (TEİD) sayfası. <http://www.teid.org/>. [10.03.2021]
- Anonim, 2021. Balda yapılan hileler. <http://www.gidadernegi.org/TR/Genel/TOSUN329d.pdf>. [10.03.2021]
- Ateş, N., 1994. Balın kalite kontrolü. Doğu Karadeniz Bölgesi Bal Paneli (26 Nisan 1993) Bildirileri. Sayfa 70-72. Trabzon.
- Ayaz, S., 2015. Bal mevzuatı. Marka Bal Olma Yolunda Samsun Sempozyumu. Sayfa 213- 219. Samsun.
- Belščak, A., Komes, D., Horžić, D., Ganić, K. K., & Karlović, D. (2009). Comparative study of commercially available cocoa products in terms of their bioactive composition. Food Research International, 42, 707–716.
- Bölükbaşı, D., 2010. Doğal, yapay ballar ve balda kalıntı. <https://dagem.duzce.edu.tr/Dokumanlar/dagem/> [10.03.2021]
- Cabañero, A. I., Recio J. L., Rupérez M., 2006. Liquid chromatography coupled to isotope ratio mass spectrometry: a new perspective on honey adulteration detection. Journal of Agricultural and Food Chemistry. 54, 9719-9727.
- Çarkçioğlu, S., 2009. Arı ürünlerine yapılan hileler ve belirleme yöntemleri. Arıcılık Araştırma Enstitüsü Eğitim Notları. 5 sayfa. Ordu.
- Çil İplikçioğlu, G., 2013. Hayvansal gıdalarda hileler ve halk sağlığı açısından önemi. Veteriner Hekimler Derneği Bülteni. Sayı 6, sayfa 12-15. Ankara.
- Damarlı, E., Coşkun, İ., 2015. Global marka olma yolunda balparmak. Marka Bal Olma Yolunda Samsun Sempozyumu. Sayfa 232- 248. Samsun.
- Güney, F., 2015. Balda saflık ve kalite testleri. Marka Bal Olma Yolunda Samsun Sempozyumu. Sayfa 171- 186. Samsun.



- Hong, E., Lee, S., 2017. Modern analytical methods for the detection of food fraud and adulteration by food category. *Journal of the Science of Food and Agriculture*, volume: 97 (12).
- Kaftanoğlu, O., 1987. Arıcılığın temel prensipleri. *Teknik Arıcılık*. Sayı 10, sayfa 7- 11. Kazan/Ankara.
- Karabal, A., 2019. Gıda mevzuatı ve gıda güvenliği. *International Journal of Social and Humanities Sciences*, 3 (1): 179-198.
- Karkacier, M., Gürel, F. ve Özdemir, F. 2000. Farklı balların hplc yöntemi ile belirlenen şeker içerikleri kullanılarak tanımlanması. *Gıda*, 25 (1): 69-73.
- Kumova, U., 2019. Ülkemizde bal sektörüne bir bakış. *Petek*. Sayı 27, sayfa 14-16. Samsun.
- Manning, L., Soon, J., 2016. Food safety, food fraud, and food defense: a fast evolving literature. *Journal of Food Science*. Volume: 81 (4).
- Pehlivanoğlu, H., 2020. Gıda güvenliği ve kalite. *Gıda Mühendisliğine Giriş* (Editör: Murat Doğan), Nobel Yayınevi, İstanbul.
- Özdemir, F., Karkacier, M., Gürel, F., 2000. Identification of different honeys using sugar composition determined by HPLC. *Gıda*, 25 (1): 69-73.
- Sıralı, R., 2010. Sahte bala acil müdahale. *Ekoloji Magazin*. Sayı 27, sayfa 60-67. İzmir.
- Sıralı, R., 2013. Toplumumuzun sahte bal algısı. *Ordu'da Gıda Güvenliği*. Yıl 7, sayı 21, sayfa 18-21. Ankara.
- Sıralı, R., 2016. Balda sahtecilik yöntemleri ve merdiven altı bal üretim sorunu. *Petek*. Sayı 17, sayfa 12-16. Samsun.
- Sıralı, R., 2019. Balda sahtecilik üzerine kırmızı çizgilerimiz. *Petek*. Sayı 27, sayfa 18-20. Samsun.
- Tansey, G., 2019. Food ethics in the UK – from small beginnings to food citizenship and beyond. 2. *Uluslararası Tarım ve Gıda Etiği Kongresi Bildirileri Özet Kitabı*. Sayfa 48.
- Türkmen, S., Ataseven, Y., 2020. Türkiye'de taklit ve tağşiş yapılan gıdalara ilişkin yasal düzenlemelerin ve uygulamaların değerlendirilmesi. *Tarım Ekonomisi Araştırmaları Dergisi*. 6 (1): 65-75.



TÜRKİYE'DE TARIMSAL FİNANSMANIN AGRI-FINTECH'LER AÇISINDAN POTANSİYELİNİN DEĞERLENDİRİLMESİ

Ümmühan Mutlu

Bahar Aydın Can

Kocaeli Üniversitesi, Hereke Ömer İsmet Uzunyol MYO, Muhasebe ve Vergi Uygulamaları Programı, Kocaeli, Türkiye

Kocaeli Üniversitesi, İzmit MYO, Tıbbi ve Aromatik Bitkiler Programı, Kocaeli, Türkiye

Özet

Her sektörde olduğu gibi tarım sektöründe de işletmelerin en temel problemlerinin başında finansman kaynağı eksikliği gelmektedir. Sektörün ihtiyaç duyduğu finansman kaynaklarının yüksek faizle sunuluyor olması, yabancı kaynak kullanımını olumsuz etkilemektedir. Bu kapsamda, tarım kredisi konusunda uzmanlaşmamış finansal kuruluşların sektörel bilgi ve uzmanlıklarının yeterli olmaması sebebiyle sektörel risk primini faiz oranlarına yansıtması, faiz maliyetlerinde artışa neden olmaktadır. Yıllar boyunca geleneksel finans yöntemleri ile finansal kaynak sağlayan tarım sektörü için süregelen problemlerin çözümünün sektörün ihtiyaçlarına özel olarak geliştirilmiş finansal tekniklerin uygulanmasını gerekli kıldığı oldukça açıktır.

Dünyada ve Türkiye 'de Fintech kavramı, finans ve teknolojinin birleşimiyle oluşan finans ve bankacılık sistemlerinde inovatif ve teknolojik hizmetler sunan girişimci şirketler olarak tanımlanabilmektedir. Agri Fintech' ler ise tarımsal sektörün ihtiyacı doğrultusunda teknolojik hizmetleri sunan yenilikçi şirketlerdir. Agri-Fintech şirketler, bankalar ile çiftçileri bir araya getirip aracılık rolüyle işi kolaylaştırmayı ve bu noktada sunulan hizmetlerle çiftçilerin maliyetlerini düşürmeyi hedeflemektedirler. Bankacılık sistemini dayanak alan Agri-Fintech şirketler, geleneksel bankacılık sisteminde detaylı olarak ele alınmayan verileri işleyerek daha öngörülebilir bir değer zinciri analizi yapılmasına olanak sağlamaktadır. Bu kapsamda, çiftçilerin finansal olarak riskli görüldüğü alanların daha detaylı değerlendirilmesi ve sektörün daha güven veren bir yapıya dönüşümüne imkân tanınmaktadır. Bu çalışmada Türkiye' de tarımsal finansmanın Agri-Fintech'ler açısından potansiyelinin değerlendirilmesine yönelik çalışmanın sonuçlarına değinilmektedir.

Keywords: Tarımsal Finansman, Fin-tech, Agri-Fintech

EVALUATION OF THE POTENTIAL OF AGRICULTURAL FINANCE IN TURKEY IN TERMS OF AGRI-FINTECHS

Abstract

As in every sector, one of the most basic problems of enterprises in the agricultural sector is the lack of financial resources. The fact that the financing resources needed by the sector are offered at high interest rates adversely affect the use of foreign resources.

In this context, the fact that financial institutions that do not specialize in agricultural loans reflect the sectoral risk premium to interest rates due to the lack of sectoral knowledge and expertise causes an increase in interest costs. It is quite clear that the solution of the ongoing problems for the



agricultural sector, which has provided financial resources with traditional financial methods for years, requires the application of financial techniques developed specifically for the needs of the sector.

In the world and in Turkey, the concept of Fintech can be defined as entrepreneurial companies that offer innovative and technological services in finance and banking systems formed by the combination of finance and technology. Agri Fintechs are innovative companies that provide technological services in line with the needs of the agricultural sector. Agri-Fintech companies aim to bring banks and farmers together, to facilitate the work by acting as an intermediary, and to reduce the costs of farmers with the services offered at this point. Agri-Fintech companies, which are based on the banking system, enable a more predictable value chain analysis by processing data that is not covered in detail in the traditional banking system. In this context, it is possible to evaluate the areas where farmers are seen as financially risky in more detail and to transform the sector into a more trustworthy structure. In this research, the results of the study on the evaluation of the potential of agricultural finance in terms of Agri-Fintechs in Turkey are mentioned.

Keywords: Agricultural Finance, Fin-tech, Agri-Fintech

Giriş

Küreselleşmenin etkisiyle bilgi ve iletişim teknolojilerinin gelişimi, sadece üretim gibi yoğun teknoloji içeren sektörlerde değil aynı zamanda finans sektöründe de ciddi değişimleri beraberinde getirmiştir. Finansal Teknoloji (FinTech) kavramı ortaya çıkmış ve bütün sektörlerde değişim yaratan bu gelişmeler tarım sektörünü ve çiftçileri de etki alanı içine almıştır. Tarım sektöründe finansal teknolojiler Agri Fintech'ler olarak karşımıza çıkmaktadır. Agri Fintech'ler, üretim çıktılarını genişletmek ve artırmak için çiftçiler de dahil olmak üzere iş aktörlerine sermaye sağlamakla ilgilidir. Agri-Fintekler, tarımsal sektörün ihtiyacı doğrultusunda teknolojik hizmetleri sunan yenilikçi şirketlerdir. Agri-Fintech şirketler, bankalar ile çiftçileri bir araya getirip aracılık rolüyle işi kolaylaştırmayı ve bu noktada sunulan hizmetlerle çiftçilerin maliyetlerini düşürmeyi hedeflemektedirler.

Tarım, tüm ülkeler açısından insanların ihtiyaç duyduğu gıda güvenliği ve sürdürülebilirliğin sağlanmasında önemli bir role sahiptir. Bu kapsamda, finansman ihtiyacı ve bu ihtiyacı karşılamada yaşanan sorunlar ve buna ek olarak sınırlı dağıtım kanalları, çiftçilerin karşı karşıya kaldıkları en temel sorunlar olarak görülmektedir. Tarım sektöründe yaşanan bu sıkıntıların giderilmesi yada azaltılabilmesi amacıyla, Finansal Teknoloji (FinTech) gibi hizmetlerin tarım sektöründe de aktif olarak kullanılması önemlidir. Finansal teknolojiler, çiftçilere kitlesel fonlama ve dijital ödeme sistemi yoluyla finansman kaynakları sağlamada ciddi katkılar sunmaktadır. Böylece dijital pazar, FinTech'in yenilikçi finansal çözümü daha geniş tarım ekosistemine entegre etmesi için bir platform görevi görebilir. Bu platformda tarım ekosistemin üyeleri; çiftçiler, toprak sahipleri, yatırımcılar ve tüketiciler olarak tarımda şeffaflık, yetkilendirme, beceriklilik ve halkın katılımı gibi bir bağlılık söz konusu olmaktadır.

Geleneksel tarımda, özellikle gelişmekte olan ülkelerde faaliyet gösteren çiftçiler açısından finansman kaynağı bulmak en önemli sorunlardandır. Finansman konusunda yaşanan bu sıkıntılar; sermaye yani fon kaynağı bulmaya yönelik yaşanan sorunlar, finansal kurumlara sınırlı erişim ve piyasaya erişim eksikliği gibi noktalarda kendini göstermektedir. Aynı zamanda, çiftçilerden tüketicilere kadar tarımın tedarik zincirlerinde yer alan ve ürün için ek maliyet yaratan birimlere erişim konusunda da sıkıntılar yaşanmaktadır. Tarım sektöründe finansal kaynak kullanımına yönelik kamu kurumlarının, tarımsal üretimi arttırmak amaçlı sundukları, sıfır faizli



kredilerin veya teşvik paketlerinin, sektörün sorunlarını hafiflettiği ancak kalıcı çözümler sunmadığı görülebilmektedir. Bu kapsamda, Agri-fintech şirketlerinin tarımsal üretim zincirini dijital pazarlar aracılığıyla daha şeffaf, belirsizliklerden arındırılmış bir hale getirmesi yoluyla bankalara alternatif birçok finansman kaynağı sunulabilmektedir.

Tarım ekonomilerindeki gelişmelere bağlı olarak tarımsal toplam faktör verimliliğinin de artması beklenmektedir. Agri- Fintech şirketler, tarımda sürdürülebilir kalkınma kapsamında tarımsal toplam faktör verimliliği ile yakın bir bağa sahiptir. Tarımsal kredilerdeki girdiler, toplam faktör verimliliğinde artışlar için gerek duyulan bir konu olmaktadır (Li & Wu, 2018). Bu kapsamda tarımla ilgili kredilerde yaşanan artışlar, kırsal sorunlara ve tarım sektörünü canlandırmaya yönelik uygulamaların geliştirilmesine olanak sağlamıştır. Bu kapsamda, bu gelişmelere rağmen tarımsal finansmanda geri çekilmeler, kurumların ve fonların çiftçilerden ayrılması, tarımsal kredilerin karşılanma oranının düşüklüğü ve tarımla ilgili kredi arzında süregelen yetersizlikler mevcuttur (Yin ve ark., 2019).

1. LİTERATÜR TARAMASI

Finansal Teknolojinin (FinTech) ve dijital pazarların faaliyete girmesiyle, araştırma, kamu veya özelde yer alan bir çok kuruluş ve üretim endüstrisi bu kavrama ilgi duymaktadır. FinTech, bu kapsamda tarım ve tarım dışı herhangi bir sektör için sektöre özel araştırmaları tetikleyen önemli bir kavram ve uygulama olarak karşımıza çıkmaktadır. Dijital pazarlar ise sektörde yeni iletişim yollarına olanak sağladığından ve tarımın iş sürecindeki aktörler olan tüketiciler, tedarikçiler, çiftçiler, yatırımcılar, distribütörler arasındaki bağlantıların oluşturulması ve sürdürülmesi açısından önemli bir konumdadır. Fintech şirketler, dijital pazarlar aracılığıyla, tarım ekonomilerinin gelişimini ve sürdürülebilirliği keşfetmek için tarım ekonomisi ve yönetimi çalışmaları ile bir çok sektörde olduğu gibi tarım sektöründe de finansal kurumların risk alma seviyesinde yükselmelere neden olmuştur.

Riskler ve maliyetlerle bağlantılı olarak, geniş bir literatür incelendiğinde, tarımla ilgili kredilerin, tarım dışı kredilere oranla daha riskli ve çok daha maliyetli olduğu savunulmaktadır (Dong vd., 2012; Zhao ve diğerleri, 2014; Lin ve diğerleri, 2019). Yapılan bir kısım çalışmada da finansal kurumların faaliyet performansı üzerindeki etkiyle ilgili olarak literatürün tarımla ilgili kredilerin finansal kurumların faaliyet performansını artırabileceğini öne sürmektedir (Guo & Jia, 2009).

Dijital pazar yeri uygulamaları ile tarım sektöründe yer alan bir çok iş sürecinde değişiklikler meydana gelmiştir (Anshari, M. & Lim, S. A., 2017). Tarımda dijital pazar uygulamaları ile farklı bölgelerden daha düşük maliyetli ve daha kaliteli tarım ürünlerinin talebi, farklı gıdalara erişim sağlanabilecek ve talepteki değişimler izlenebilecektir (Silva, 2009). Bu sebeple, FinTech'in sunduğu hizmetlerin dijital pazarlarda yer alması yoluyla tarım sektöründe karşılaşılan sorunlara özellikle çiftçilerin karşı karşıya olduğu mali sorunların giderilmesi ve halkın tarım üretimine teşviki kapsamında sunulan destek oldukça önemlidir (Anshari, M., & Alas, Y. (2015). Fintech teknolojisinin sunduğu yenilikler, daha yüksek bir dijitalleşme seviyesi ve otomasyon sunmaları nedeniyle önemli ölçüde maliyetlidir (Dubey, 2019).

FinTech ve finansal hizmetler sayesinde, tarım sektörünün de diğer sektörlerle birlikte küresel ekonomide rekabet etmesine olanak sağlanabilmektedir. Fintech şirketlerin sunduğu finansal hizmetler; mobil ödemeler, para transferleri, krediler, bağış toplama, varlık yönetimi ve ödemeler/faturalandırma gibi hizmetlerden oluşmaktadır. FinTech, sektördeki tüm aktörleri kişiselleştirilmiş hizmetler ile ticari işlemlerini uygun şekilde yürütebilmeleri sayesinde birbirine bağlayabilmekte ve yenilikçi bir platform oluşturmaktadır. Kitle fonlaması sayesinde yatırımcıların,



ilgilendikleri tarım ürünleri arasından seçim yapabilmeleri müşterilerin fiyat bilgisine ulaşma, karşılaştırma ve ödeme yapma olanağı bulmaları açısından değerlidir. Bu olanaklar, tarımsal ürün tedarikçileri arasındaki fiyat rekabetini artırmakta ve tarım ürününün sürdürülebilirliğini geliştirmektedir (Anshari, Almunawar, Masri & Hamdan, 2018). Ayrıca FinTech hizmetleri, ticari işlemlerin herhangi bir zamanda herhangi bir yerden gerçekleştirilmesine olanak tanıyarak tüm aktörler için esneklik sağlamaktadır (Anshari, Almunawar, Masri & Hamdan, 2019). Fintech'i uygulayan şirketler, bankacılık hizmetlerini mobil uygulamalarla, müşterilere ve yatırımcılara ulaştırmak için daha kaliteli yenilikçi yöntemlere sahiptir. Bu yenilikçi teknolojiler ve hizmetler, finansal hizmetlerin tarım sektörü gibi yeterli olmadığı alanlarda, piyasa ihtiyaçlarını karşılamaya yardımcı olmaktadır (Guild, 2017). FinTech hizmetleri, finansal hizmetlere esneklik ve verimlilik getirirken, fintech şirketlerin öne sürdüğü en temel hedefin, dijital teknolojiler sayesinde zamandan ve maliyetten tasarrufun sağlanabilmesidir. Bunun sağlanabilmesi için yöneticilerin bu kaynaklara ve yeni yeteneklere yatırım yapmaları ve bankacılık sektörünün yenilikçi teknolojiler e yönelik prosedürlerini geliştirmeleri oldukça önemlidir (Bofondi & Gobbi, 2017).

SONUÇ

Tarımla ilgili kredilerin tarım dışı kredilerden daha riskli olduğu göz önüne alındığında, bankaların ve diğer finansal kurumların risk alma düzeyi Agri- Fintech gibi yenilikçi şirketler nedeniyle değişim gösterebilmektedir. Agri- Fintech şirketler, bankaları ve diğer finansal kurumları tarımla ilgili kredilerin oranını artırma konusunda teşvik etmektedir. Diğer yandan tarımsal finansmanda canlılık yaratmak ve tarım finansmanında yaşanan sorunları hafifletmek adına önemli gelişmeler görülmektedir.

Bankacılık sistemini dayanak alan Agri-Fintech şirketler, geleneksel bankacılık sisteminde detaylı olarak ele alınmayan verileri işleyerek daha öngörülebilir bir değer zinciri analizi yapılmasına olanak sağlamaktadır. Bu kapsamda, çiftçilerin finansal olarak riskli görüldüğü alanların daha detaylı değerlendirilmesi ve sektörün daha güven veren bir yapıya dönüşümüne imkân tanınmaktadır. Agri-Fintech şirketler tarım işletmelerinin rekabet gücünü etkin bir şekilde artırmaktadır. Tüm ilgili taraflar için yapılan hizmetlerin geri dönüşünün karlılıkla sonuçlandığına yönelik çalışmalar sunulmuştur. Çalışmalar, fintech inovasyonunu uygulayan bankaların önemli ölçüde maliyet tasarrufu sağlamasını ve tüm aktörler için esnek finansal hizmetler sunmasını sağlamıştır.

KAYNAKLAR

Anshari, M., & Alas, Y. (2015). Smartphones habits, necessities, and big data challenges. *The Journal of High Technology Management Research*, 26(2), 177-185.

Anshari, M., & Lim, S. A. (2017). E-government with big data enabled through smartphone for public services: Possibilities and challenges. *International Journal of Public Administration*, 40(13), 1143-1158.

Anshari, M., Almunawar, M. N., Masri, M., & Hamdan, M. (2019). Digital marketplace and FinTech to support agriculture sustainability. *Energy Procedia*, 156, 234-238.

Bofondi, M., & Gobbi, G. (2017). The big promise of FinTech. *European economy*, (2), 107-119.

Da Silva, C. A. (2009). *Agro-industries for development*. CABI.



- Dong, F., Lu, J., & Featherstone, A. M. (2012). Effects of credit constraints on household productivity in rural China. *Agricultural Finance Review*, 72(3), 402–415. <https://doi.org/10.1108/00021461211277259>.
- Dubey, V. (2019). FinTech Innovations in Digital Banking. *International Journal of Engineering Research & Technology (IJERT)*, 8(10), 2278-0181. doi: <http://www.ijert.org>.
- Guild, J. (2017). Fintech and the Future of Finance. *Asian Journal of Public Affairs*, 17-20.
- Li, W., & Wu, P. (2018). Rural financial development, agricultural fiscal investment and rural residents income. In *DEStech transactions on economics, business and management*. icems. <https://doi.org/10.12783/dtem/icems2018/25595>.
- Lin, L., Wang, W., Gan, C., & Nguyen, Q. T. T. (2019). Credit constraints on farm household welfare in Rural China: Evidence from Fujian Province. *Sustainability*, 11(11), 3221. <https://doi.org/10.3390/su11113221>.
- Yin, Z., Qiu, M., & Gan, L. (2019). Information contents of collateral under heterogeneous borrower qualities on the bank loans market in China. *China Economic Review*, 57(5), 101326. <https://doi.org/10.1016/j.chieco.2019.101326>.
- Zhao, J., Zhang, J., & Barry, P. J. (2014). Do formal credit constraints affect the rural household consumption in China? *Agricultural Economics (ZemědělskáEkonomika)*, 60(No. 10), 458–468.



TÜRKİYE’DE KİMYASAL GÜBRE ÜRETİMİ, TÜKETİMİ, DIŞ TİCARETİ VE DESTEKLEMELERİN DEĞERLENDİRİLMESİ

Bahar Aydın Can
Ümmühan Mutlu

Kocaeli Üniversitesi, İzmit MYO, Tıbbi ve Aromatik Bitkiler Programı, Kocaeli, Türkiye
Kocaeli Üniversitesi, Hereke Ömer İsmet Uzunyol MYO, Muhasebe ve Vergi Uygulamaları Programı, Kocaeli, Türkiye

Özet

Gübre, artan dünya nüfusunun beslenme ihtiyaçlarının karşılanması için gerekli olan tarım ürünlerinin üretilmesinde önemli girdilerden biridir. Dünyadaki birçok ülkede kırsal nüfusun azalması beraberinde yetersiz üretim ve kıtlık sorununu getirmektedir. Bu nedenle kimyasal gübre daha fazla ürün alabilmek için verimliliğin artırılmasında önemli bir unsur olmaktadır. 2020 yılında dünyada toplam 123.1 milyon ton azotlu, 44.8 milyon ton fosforlu ve 44.9 milyon ton potasyumlu gübre üretilmiştir. Dünyada en fazla azotlu ve fosforlu gübre kullanan ülke Çin iken, en fazla potasyumlu gübre kullanan ülke ABD’dir. Türkiye kimyasal gübre kullanımında 72.8 kg/ha azotlu gübre kullanımı ile dünya ortalamasının üzerinde, 26.9 kg/ha fosforlu gübre kullanımı ile dünya ortalamasına yakın, 5 kg/ha potasyumlu gübre kullanımı ile dünya ortalamasının altındadır. Türkiye 2021 yılında 2.1 milyon ton kimyasal gübre tüketmiştir. Kimyasal gübre üretimimiz 1,7 milyon ton ile tüketimi karşılayabilecek seviyede değildir. Türkiye’de kimyasal gübre üretimi yıllara göre artış göstermesine rağmen, üretim tüketimi karşılamadığı için ihtiyacımız ithalat yoluyla karşılanmaktadır. 2020 yılında 2 milyon ton gübre ithalatımızın %71.16’sı azotlu gübre olarak gerçekleştirilmiştir. Kimyasal gübre fiyatlarındaki artış nedeniyle, ayrıca toprak analizine dayalı gübre kullanım bilincini kazandırmak için 2005 yılından itibaren çiftçilere düzenli olarak gübre desteği verilmeye başlanmıştır. 2005 yılında Türkiye’de çiftçilere ödenen toplam 271 milyon TL gübre desteği 5.8 kat artarak 2021 yılında 1.5 milyar TL seviyesine ulaşmıştır. Bu çalışmanın amacı, Türkiye’de 20 yıllık (2002-2021) dönemde kimyasal gübrenin üretim, tüketim, dış ticaret ve destekleme yönünden durumunu inceleyerek, dünyadaki yerini ortaya koymaktır. Çalışmanın ana materyalini Türkiye İstatistik Kurumu (TUIK), Tarım ve Orman Bakanlığı, Tarımsal Araştırma ve Geliştirme Genel Müdürlüğü (TAGEM), Birleşmiş Milletler Gıda ve Tarım Örgütü (FAO), International Trade Center (ITC)’den elde edilen veriler oluşturmaktadır. Verilerin değerlendirilmesinde yüzde ve indeks hesaplamaları yapılmış, çizelge ve grafikler halinde sunulmuştur.

Keywords: kimyasal gübre, üretim, tüketim, dış ticaret, desteklemeler.



**AN EVALUATION OF CHEMICAL FERTILIZER PRODUCTION, CONSUMPTION,
FOREIGN TRADE AND SUPPORTS IN TURKEY**

Abstract

Fertilizer is one of the important inputs in the production of agricultural products necessary to meet the nutritional needs of the growing world population. The decline of the rural population in many countries around the world brings with it the problem of insufficient production and scarcity. For this reason, chemical fertilizer is an important element in increasing productivity in order to get more products. In 2020, a total of 123.1 million tons of nitrogenous, 44.8 million tons of phosphorus and 44.9 million tons of potassium fertilizers were produced in the world. While China is the country that uses the most nitrogen and phosphorus fertilizers in the world, the country that uses the most potassium fertilizers is USA. Turkey is above the world average with the use of 72.8 kg/ha nitrogen fall in chemical fertilizer use, close to the world average with the use of 26.9 kg/ha phosphorus fertilizer, below the world average with the use of 5 kg/ha potassium fertilizer. Chemical fertilizer production is also not at a level that can meet consumption with 1.7 million tons. Although the production of chemical fertilizers in Turkey has increased over the years, our needs are met through imports because production does not meet consumption. In 2020, 71.16% of our 2 million tons of fertilizer imports were realized as nitrogen fertilizer. Due to the increase in chemical fertilizer prices, fertilizer support has been regularly provided to farmers since 2005 in order to raise awareness of fertilizer use based on soil analysis. In 2005, a total of TL 271 million of fertilizer support paid to farmers in Turkey increased by 5.8 times and reached TL 1.5 billion in 2021. The aim of this study is to reveal the place of chemical fertilizer in the world by examining the status of chemical fertilizer in terms of production, consumption, foreign trade and support in Turkey in the 20-year period (2002-2021). The main material of the study consists of data obtained from the Turkish Statistical Institute (TURKSTAT), the Ministry of Agriculture and Forestry, the General Directorate of Agricultural Research and Development (TAGEM), the Food and Agriculture Organization of the United Nations (FAO), the International Trade Center (ITC).

Keywords: chemical fertilizer, production, consumption, foreign trade, supports.

1.GİRİŞ

Gübre bitkisel üretimde en önemli girdilerden biridir. Gübreler bitkilerin daha iyi beslenmesi ve toprağın fiziksel, kimyasal ve biyolojik özellikler bakımından daha verimli olabilmesi için toprağa ilave edilen doğal ve yapay maddelerdir (Katıp, 2020). Artan nüfus karşısında, kırsaldaki tarımla uğraşan nüfusun azalması beraberinde yetersiz tarımsal üretimi getirmektedir. Bu açıdan birim alandan yüksek verim alabilmek için, kimyasal gübre kullanımı tarımsal üretim ihtiyacının karşılanmasında önemli rol oynamaktadır. Gübre kullanımının bitkisel üretim artışındaki payı %50-75 arasında değişmekte olup, ülkemiz ve dünyanın her yerinde verim artışı ve gübre tüketimi arasında sıkı bir ilişki vardır (Eyüpoğlu, 2002). Hızla artan dünya nüfusunun 2050 yılında 9.2 milyara ulaşacağı düşünüldüğünde gıda maddeleri gereksinimindeki artış ve kişi başına düşen ekilebilir alanın azalması, birim alandan daha fazla bitkisel üretim gerçekleştirdiğinden, gübrelerin bugün olduğu gibi gelecekte de sürdürülebilir tarımın en önemli girdilerinden biri olması kaçınılmazdır (İnal ve ark., 2020).

Kimyasal gübre grubunda temel üç tip gübre bulunmaktadır; azotlu gübre, fosforlu gübre ve potasyumlu gübre. Bunlardan azotlu gübre hem dünyada hem de Türkiye’de en fazla tüketilen ve



bitkisel üretimde önemli yeri olan grubu teşkil etmektedir (Polat, 2020). Dünya genelinde 2020 yılında ile yaklaşık 200 milyon ton tüketilen toplam NPK içerisinde % 56.48'lik payı ile azotlu gübreler önemli yer tutmaktadır (FAO, 2022). Dünyada azotlu gübre tüketimi artarken, fosforlu ve potasyumlu gübre tüketimi azalma eğilimindedir.

Dünya gübre üretimi hammadde kaynaklarına ve tüketime göre şekillenmiştir. Çin, Hindistan, Rusya, ABD ve Kanada gibi geniş tarım arazisi ve yoğun nüfusa sahip ülkelerin önemli üretim kapasitesi bulunmaktadır. Fosforlu gübrelerde de fosfat kıyasına sahip ülkelerin (Kuzey Amerika, Orta ve Kuzey Afrika Ülkeleri) üretim fazlalığı vardır (TAGEM, 2018).

Türkiye kimyasal gübre sektöründe genel olarak artış eğiliminde olduğu üretimin, tüketimi karşılamadığı görülmektedir. Türkiye'de hammadde kaynakları bulunmadığından kimyasal gübre sektörü önemli ölçüde dışa bağımlıdır (İlgar, 2020). Kimyasal gübre ihtiyacımız daha çok ithalat yoluyla karşılanmaktadır. 2020 yılında yaklaşık 2.5 milyon ton NPK kullanımının %60.50'si ithal edilmiştir. Aynı yıl gübre ihracatımızda toplam NPK üretimimizin %5.07'si kadar gerçekleştirilmiştir. Türkiye'nin gübre ihracatı oldukça düşüktür. Bunun en önemli nedenleri arasında hammadde de dışa bağımlı olmamız, üretim maliyetlerinin yüksekliği ve özellikle azotlu gübrede ihracatçı ülkelerle rekabet edebilecek yapıya sahip olmamız gelmektedir. Gübre sektöründe dışa bağımlı olmamız, gelecekte bitkisel üretime bağlı gıda ihtiyacımızın karşılanmasında önemli bir tehdit oluşturmaktadır.

Tarımda üretimin arttırılmasında stratejik öneme sahip olan kimyasal gübrelerde üretim, tüketim ve dış pazar yapımızın güncel verilerle incelenerek durumumuzun ortaya konması önem arz etmektedir. Bu çalışmada, Türkiye'nin kimyasal gübrede üretim, tüketim, dış ticaret ve destekleme yönünden durumunu incelenmiş, dünyadaki yeri ortaya konmuş ve tespit edilen sorunlar karşısında çözüm önerileri getirilmiştir.

2. MATERYAL VE YÖNTEM

Çalışmanın ana materyalini Türkiye İstatistik Kurumu (TUIK), Tarım ve Orman Bakanlığı, Tarımsal Araştırma ve Geliştirme Genel Müdürlüğü (TAGEM), Birleşmiş Milletler Gıda ve Tarım Örgütü (FAO), International Trade Center (ITC)'den elde edilen veriler ile konuyla ilgili daha önce yapılan araştırmalardan elde edilen sonuçlar oluşturmaktadır. Çalışmada çeşitli kurumlardan elde edilen 2002-2021 dönemi verileri değerlendirilmiş ve yorumlanmıştır. Verilerin değerlendirilmesinde yüzde ve indeks hesaplamaları yapılmış, çizelge ve grafikler halinde sunulmuştur.

3. ARAŞTIRMA SONUÇLARI

3.1. Dünyada Kimyasal Gübre Sektörü

3.1.1. Dünyada Kimyasal Gübre Üretimi

Dünyada toplam azot (N), fosfor (P) ve potasyum (K) bazlı gübre verilerinde 2020 yılında yaklaşık 123 milyon ton toplam NPK üretilmiştir. Tablo 1'de dünyada ülkelere göre azot üretiminde 32 milyon ton ve %25.99 pay ile Çin ilk sıradadır (Tablo 1). Hindistan (%11.16), ABD (%10.77) ve Çin dünya toplam azotlu gübre üretiminin yaklaşık yarısını karşılamaktadır. Dünya azotlu gübre üretiminde Türkiye %1.19 ile düşük orana sahiptir.



Tablo 1: Dünyada Ükelere Göre Azotlu Gübre Üretimi(ton)

Ükeler	2016	2017	2018	2019	2020	Dağılım(%)
Çin	37436500	34812344	32657767	32396037	32010545	25.99
Hindistan	13376800	13422600	13336800	13722200	13744500	11.16
ABD	9969020	11346552	12749145	13261507	13261507	10.77
Rusya	9474800	10052200	10421300	10913200	11189700	9.09
Mısır	1800000	2800000	3700000	4200000	4500000	3.65
Endonezya	3546274	3805697	4022317	4137668	4292830	3.49
Kanada	4122960	3735920	3822840	3927800	2726165	2.22
Türkiye	775026	876701	979901	1143689	1469117	1.19
Almanya	1371485	1321607	1486441	1508707	1408090	1.14
Diğer	37532931	38503966	38054015	38776555	38542598	31.3
Dünya	119405796	120677587	12130526	123987363	123145052	100

Kaynak: www.fao.org

2020 yılında dünyada %29.55 pay ve 13 milyon ton ile Çin en önemli fosfor üreticisi ülkedir. Çin'i % 10.26 ile ABD ve %10.56 ile Hindistan takip etmektedir. Dünya fosforlu gübre üretiminin yarısını bu önemli üç üretici ülke karşılamaktadır. Türkiye fosforlu gübre üretiminde son beş yılda %54.53 artışla fosforlu gübre üretimini önemli ölçüde artıran ülkelerden biri olmuştur (Tablo 2).

Tablo 2:Dünyada Ükelere Göre Fosforlu Gübre Üretimi (ton)

Ükeler	2016	2017	2018	2019	2020	Dağılım(%)
Çin	18633873	15060418	13279499	13277276	13258012	29.55
ABD	6698300	6509200	4600400	4600400	4600400	10.26
Hindistan	4552700	4724400	4590500	4790700	4737200	10.56
Rusya	3576000	3865500	3992600	4115200	4246600	9.46
Fas	2764620	4023400	3715400	3715400	3715400	8.28
Brezilya	1518396	1627807	2031723	1463103	3544674	7.9
Türkiye	492866	522848	468740	497642	761628	1.7
Endonezya	628595	713304	681260	659062	661392	1.47
Diğer	9384137	9498532	9508596	9306725	8879371	19.79
Dünya	48530900	46953810	43331517	42888308	44867477	100

Kaynak: www.fao.org

Tablo 3'de 2020 yılında dünya potasyumlu gübre üretiminin %7.12'sinin Kanada, %21.11'nin Rusya, %16.84'ünün Belarus ve % 13.73'ünün Çin tarafından gerçekleştiği görülmektedir. Son beş yılda Belarus %22.36 üretim artışıyla potasyumlu gübre üretimde en fazla artış sağlayan üretici ülkedir. Potasyumlu gübre üretimde hammadde kaynaklarına sahip ülkeler en fazla üretimi yapmaktadır. Türkiye'deki potasyumlu gübre üretimi oldukça düşüktür.

Tablo 3:Dünyada Ükelere Göre Potasyumlu Gübre Üretimi

Ükeler	2016	2017	2018	2019	2020	Dağılım(%)
Kanada	10711800	12179400	13989800	12179400	12179400	27.12
Rusya	7770000	8649400	8547600	8675000	9477000	21.11
Belarus	6180050	7101799	7346096	7348293	7562153	16.84
Çin	6650400	5966063	6145883	6145883	6167770	13.73
Almanya	2759005	2849186	2524999	2413966	2530172	5.63
İsrail	1930932	2230429	2288125	2081322	2162249	4.81
Şili	1200000	1100000	1200000	840000	900000	2.01
ABD	465579	391379	381579	369839	369839	0.82
Türkiye	0	0	0	99844	112870	0.25
Diğer	3151212	3384633	3501637	3517344	3451157	7.68
Dünya	40818978	43852289	45925719	43670891	44912610	100

Kaynak: www.fao.org



3.1.2. Dünyada Kimyasal Gübre Tüketimi

Dünya NPK gübre tüketimi 2016 yılında 188 milyon ton gerçekleşmiş olup, 2020 yılında 200 milyon ton seviyesine yükselmiştir. Toplam kimyasal gübre tüketiminde azotlu gübre %56.48, fosforlu gübre %23.99 ve potasyumlu gübre %19.53'lük pay oluşturmaktadır. 2016-2020 yılları arasında dünya kimyasal gübre tüketiminde fosforlu gübreler %10.37 artışla en fazla artış sağlayan kimyasal gübrelerdir. Aynı yıllar arasında potasyumlu gübre tüketiminde %6.60 ve azotlu gübre tüketiminde % 5.21 artış gerçekleşmiştir.

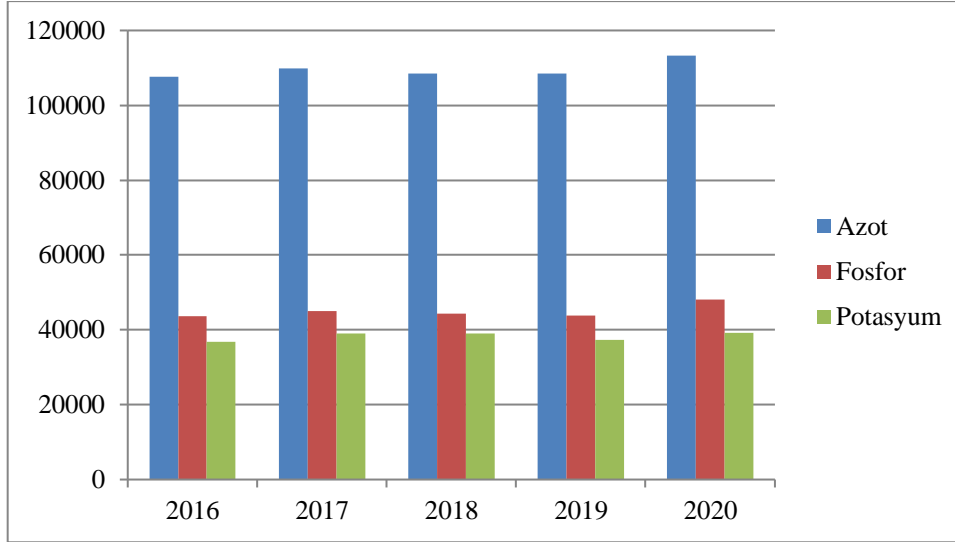

Şekil 1: Dünyada Yıllara Göre Kimyasal Gübre Tüketimi (000 ton)

Kaynak: www.fao.org

Şekil 2’de 2020 yılında dünyada kimyasal gübreyi en fazla kullanan ülkeler incelendiğinde Çin 25 milyon ton azotlu gübre, 10 milyon ton fosforlu ve 10 milyon ton potasyumlu gübre kullanımı ile ilk sıradadır. Hindistan azotlu ve fosforlu gübre tüketiminde ikinci sıradadır. Potasyumlu gübre kullanımında Brezilya 7 milyon ton ile ikinci sırada yer almaktadır.

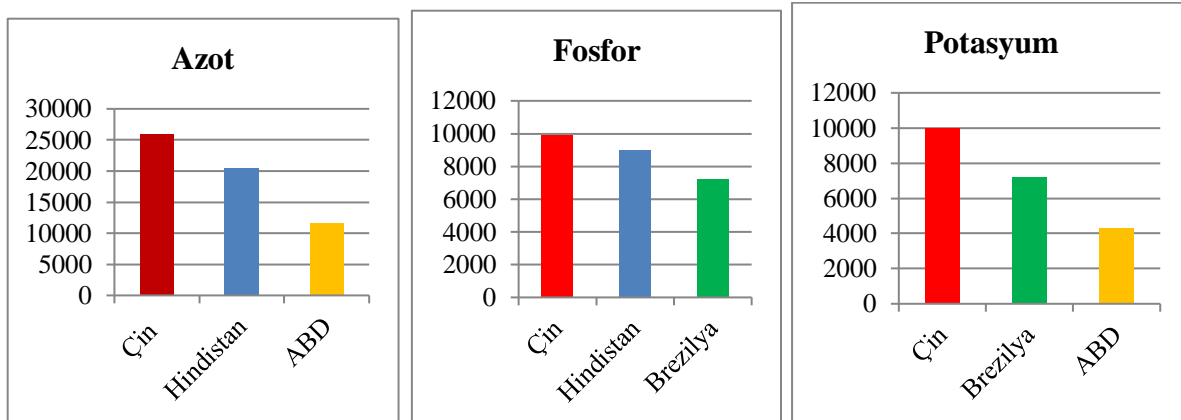

Şekil 2: Dünya En Fazla Kimyasal Gübre Kullanan Ülkeler

Kaynak:www.fao.org

3.1.3. Dünya Kimyasal Gübre Dış Ticareti

Dünya kimyasal gübre dış ticaretinde 2020 yılında yaklaşık 44.7 milyon ton azotlu gübre ihracatı yapılmıştır (Tablo 4). 2016-2020 yılları arasında dünyada azotlu gübre ihracatı %12.21 artış göstermiştir. En fazla azotlu gübre ihracatını %14.7 payı ile Rusya gerçekleştirmiş olup, Rusya’yı



%13.59 ile Çin ve %5.5 ile Suudi Arabistan takip etmiştir. Azotlu gübre ihracatında ihracatçı ülkeler arasında en fazla artış sağlayan ülke %12.24 artışı ile Rusya olmuştur. Türkiye 2020 yılında %0.78 azotlu gübre ihracatı ile oldukça düşük paya sahiptir. Gelişen ve büyük tüketici ülkeler, gübrenin mevsimsel özelliği ve fiyat istikrarsızlığı gibi nedenlerden dolayı ulusal sanayilerini oluştururken, hammadde kaynaklarına sahip ülkeler ise ihracat amaçlı kapasite yaratmışlardır (Anonim, 2008).

Tablo 4: Dünya Azotlu Gübre İhracatı

Ülkeler	2016	2017	2018	2019	2020	2020 Dağılım(%)
Rusya	6249356	6486830	7080716	7188073	7020503	14.7
Çin	6129252	5555779	4947648	6061171	6489955	13.59
Suudi Arabistan	2125142	2186359	2269329	2253568	2650375	5.55
Katar	2267471	2424771	2258813	2377259	2332013	4.88
Hollanda	2236812	2168681	1963663	2088769	2007642	4.2
İran	1572871	1661689	1639893	1639893	1639893	3.43
ABD	1535359	1902860	1727643	1581211	1637814	3.42
Türkiye	91015	186247	241068	352218	372515	0.78
Diğer	20367187	21951282	23039377	23144890	23622203	49.45
Dünya	42574465	44524498	45168150	46687052	47772913	100

Kaynak: www.fao.org

Dünya fosforlu gübre ihracatı 2016-2020 yılları arasında %25.91’lik artış oranı ile 22.3 milyon seviyesine ulaşmıştır (Tablo 5). 2020 yılında Fas, Çin ve Rusya toplam ihracatın %57.66’sını karşılamıştır. Suudi Arabistan yaklaşık son 10 yılda fosfor ihracatında gösterdiği artışla %8.69 ihracat oranı ile 5.sırada yer almıştır. Türkiye 205 bin ton fosfor ihracatı ile %0.92 paya sahiptir.

Tablo 5:Dünya Fosforlu Gübre İhracatı

Ülkeler	2016	2017	2018	2019	2020	2020 Dağılım(%)
Fas	2692944	3202945	3496399	3854295	4928523	22.09
Çin	3999468	5315065	5756996	5350889	4921732	22.05
Rusya	2528937	2777416	3120758	2952178	3016339	13.52
ABD	2183255	2309487	1943960	2104936	2122769	9.51
Suudi Arabistan	1084856	1283257	1653199	2099497	1939594	8.69
Belçika	351352	394642	384615	367944	399944	1.79
Litvanya	440836	408572	385313	369244	372563	1.67
Türkiye	87437	81773	105683	132882	205548	0.92
Diğer	4354101	4440294	4641119	4221684	4408933	19.76
Dünya	17723186	20213451	21488042	21453549	22315945	100

Kaynak: www.fao.org

2020 yılında gerçekleşen 34.7 milyon ton potasyumlu gübre ihracatının %36.73’ünü Kanada, % 18.88’ini Rusya ve %14.84’ünü Belarus gerçekleştirmiştir (Tablo 6). 2016-2020 yılları arasında en büyük ihracatçı ülkelerde Kanada %32.68 artışıyla en fazla artış sağlayan ülke durumundadır. Türkiye’nin potasyumlu gübre ihracatı azotlu ve fosforlu gübrelere göre oldukça düşük seviyededir.

Tablo 6: Dünya Potasyumlu Gübre İhracatı

Ülkeler	2016	2017	2018	2019	2020	2020 Dağılım(%)
Kanada	9633678	11486354	13171558	11742346	12781755	36.73
Rusya	12025503	14089840	6194826	6467962	6568932	18.88
Belarus	4200573	6532546	5804718	6318818	5162544	14.84
Almanya	1539298	2574472	2228280	2153025	2266948	6.51
İsrail	1848610	2262981	2250019	2066840	2168213	6.23
Ürdün	853840	1220638	1151721	1241583	1317433	3.79
Çin	328958	303455	319662	593455	643626	1.85
Türkiye	13269	14876	14177	34228	29469	0.08
Diğer	4334884	4628711	4101590	3699222	3860813	11.09
Dünya	34778613	43113873	35236551	34317479	34799733	100



Kaynak: www.fao.org

2020 yılında dünya azotlu gübre ithalatının %25.98'ini Hindistan ve Brezilya gerçekleştirmiştir (Tablo 7). 2016-2020 yılları arasında dünya azotlu gübre ithalatı 41.4 milyon ton dan 47.8 milyon tona çıkarak %15.40 artış göstermiştir. İthalatçı ülkeler arasında Brezilya %57.17 ve Hindistan %54.56 artış oranlarıyla en yüksek artış sağlayan ülkeler durumundadır.

Tablo 7: Dünya Azotlu Gübre İthalatı

Ülkeler	2016	2017	2018	2019	2020	Dağılım(%)
Hindistan	4346736	3706225	3893711	6529953	6718521	14.04
Brezilya	3634012	4653258	4542947	4780941	5711771	11.94
ABD	4783867	4320511	4203366	4088223	3638029	7.6
Fransa	2118242	2146822	1993431	1940314	1888108	3.95
Avustralya	1377809	1280706	1213517	1301297	1528248	3.19
Tayland	1461030	1629550	1482827	1285908	1463492	3.06
Türkiye	1526486	1761991	1391751	1694106	1452332	3.03
Almanya	1273069	1231491	963455	1005405	995902	2.08
Diğer	20946926	22964167	23156707	23558947	24456583	51.11
Dünya	41468177	43694721	42841712	46185094	47852986	100

Kaynak: www.fao.org

Dünya fosforlu gübre ithalatında 2016-2020 yılları arasında %19.47 artışla 22 milyon ton seviyesine ulaşmıştır (Tablo 8). Hindistan(%15.06), Brezilya (%17.47) ve ABD (%5.42) ithalatın %37.95'ni oluşturan en önemli ithalatçı ülkelerdir. Kanada 2016-2020 yılları arasında %77.17 artışla en fazla artış sağlayan, dünya fosforlu gübre ithalatında 4.sırada yer alan ülkedir.

Tablo 8:Dünya Fosforlu Gübre İthalatı

Ülkeler	2016	2017	2018	2019	2020	Dağılım(%)
Hindistan	2404928	2038376	3090728	2918129	3320906	15.06
Brezilya	2724306	3204906	3147370	3493347	3851367	17.47
ABD	908322	1122152	1657165	1678317	1194707	5.42
Kanada	582068	662878	735231	929766	1031303	4.68
Arjantin	688842	579034	658253	583195	796894	3.61
Avustralya	788199	661357	668224	711586	707807	3.21
Endonezya	719804	959892	874258	622898	612004	2.78
Türkiye	514499	450178	289699	452633	360249	1.63
Diğer	9125091	10461931	9834406	10064344	10173826	46.14
Dünya	18456059	20140704	20955334	21454215	22049063	100

Kaynak: www.fao.org

2020 yılında dünyada toplam 38.9 milyon ton potasyumlu gübre ithalatı gerçekleştirilmiştir (Tablo 9). ABD %18.42 oranıyla en fazla ithalat gerçekleştiren ülkedir. Brezilya %18.03 ve Çin %14.98 ile diğer önemli ithalatçı ülkelerdir. Brezilya %50.08 artışıyla en fazla artış sağlayan ülkedir. Türkiye potasyumlu gübre ithalatında %0.59'luk paya sahiptir.

Tablo 9: Dünya Potasyumlu Gübre İthalatı

Ülkeler	2016	2017	2018	2019	2020	Dağılım(%)
ABD	5383792	7455209	7815048	7008527	7174065	18.42
Brezilya	4676654	6027674	6533832	6560377	7019107	18.03
Çin	4103224	4985094	4970684	5977190	5831516	14.98
Endonezya	1659916	2101478	2176494	1740134	1785213	4.58
Malezya	1005091	1065714	1115422	734967	848790	2.18
Polonya	670838	691675	713223	689910	755650	1.94
Türkiye	150366	167783	168550	178629	228299	0.59
Diğer	10716772	13589149	11777561	11280629	12068722	30.99
Dünya	30692150	38832438	38073637	36823838	38937574	100



Kaynak: www.fao.org

3.2. Türkiye’de Kimyasal Gübre Sektörü

3.2.1. Türkiye’de Kimyasal Gübre Üretimi

Türkiye’de ilk defa 1928 yılında Türkiye Şeker Şirketi A.Ş.’nin gübre ithal etmesi ile kimyevi gübre kullanımı başlamıştır (Olhan, 2000). İlk gübre üretimimiz 1939 yılında amonyum sülfat gübresi olarak Türkiye Demir Çelik İşletmeleri tarafından üretilmiştir (Eyüpoğlu, 1992). 2002-2021 yılları arasında Türkiye’de üretilen kimyasal gübreler Tablo 10’da verilmiştir. 2021 yılında gerçekleşen toplam 1.77 milyon ton kimyasal gübre üretimimizin %74.59’unu azotlu gübreler, %18.18’ini fosforlu gübreler ve %7.23’ünü potasyumlu gübreler oluşturmaktadır. 2002-2021 yılları arasında NPK gübre üretimimizde en fazla artış %98.40 ile potasyumlu gübrede olmuştur. Fosforlu gübre üretimimizde aynı dönemde % 81.67 artış yaşanırken, azotlu gübre üretimimize %58.19 artış gerçekleşmiştir. Türkiye kimyasal gübre üretiminde en fazla üretim artışı %75.41 ile 2020 yılında gerçekleştirilmiştir. Gübre üretiminde hammadde maliyeti belirleyen en önemli unsurdur. Türkiye’de hammaddelerin büyük kısmı ithal edildiğinden, uluslararası hammadde fiyatları ve döviz kurları üretimimizi olumsuz yönde etkilemektedir. Özellikle fosfat kayasına sahip ABD, Rusya, Fas, Tunus ve Ürdün ile üretim maliyetleri bakımında rekabet şansımız bulunmamaktadır (DPT,2000).

Tablo 10: Türkiye Yıllar İtibariyle Gübre Üretimi

Yıllar	Azot (N)	Posfor (P)	Potasyum (K)	Toplam (N+P+K)	İndeks 2002=100
2002	837927	177800	64750	1080477	100.00
2003	775290	181816	68699	1025805	94.94
2004	756668	152011	70390	979069	90.61
2005	740150	165229	72417	977796	90.50
2006	699525	168018	54738	922281	85.36
2007	653882	185823	62824	902529	83.53
2008	666459	163815	57045	887319	82.12
2009	624971	188084	24465	837520	77.51
2010	768588	230338	42079	1041005	96.35
2011	929709	197833	53710	1181252	109.33
2012	905087	190839	60105	1156031	106.99
2013	865777	190114	70878	1126769	104.28
2014	821860	212935	75810	1110605	102.79
2015	867370	225302	98983	1191655	110.29
2016	775026	215185	83214	1073425	99.35
2017	876701	228275	97981	1202957	111.34
2018	979901	204652	86474	1271027	117.64
2019	1143689	217270	82851	1443810	133.63
2020	1469117	332527	93660	1895304	175.41
2021	1325527	323012	128465	1777004	164.46

Kaynak: www.tuik.gov.tr

3.2.2. Türkiye’de Kimyasal Gübre Tüketimi

Türkiye’nin kimyasal gübre tüketimine ilişkin 2002-2021 yılları arasındaki durumu Tablo 11’de verilmiştir. Kimyasal gübre tüketimimizde dalgalanmaları olduğu, en yüksek tüketimin 2.4 milyon ton ile 2020 yılında gerçekleşmiştir. Toplam NPK gübre tüketimimizin 1.4 milyon tondan 2.1 milyon ton seviyesine çıkarak %49.39 oranında artış gösterdiği görülmektedir. Toplam NPK gübre tüketimimizde azotlu gübreler % 81.54 ile en yüksek paya sahiptir. 2002-2021 yılları arasında tüketimde en fazla artış %109.63’lük pay ile potasyum tüketiminde gerçekleşmiştir. Türkiye kimyasal gübre tüketiminde çoğunu ithalat yoluyla karşılamaktadır. Türkiye’de çıkarılan doğal gaz



miktarı ülke tüketiminin sadece %1'i düzeyindedir (Ilgar,2020). Bu nedenle kimyasal gübre üretimimiz tüketimimizi karşılamamaktadır.

Tablo 11: Türkiye Yıllar İtibariyle Gübre Tüketimi

Yıllar	Azot (N)	Posfor (P)	Potasyum (K)	Toplam (N+P+K)	İndeks 2002=100
2002	1199130	207131	61046	1467307	100
2003	1340867	238447	69389	1648703	112.36
2004	1366618	257751	72662	1697031	115.66
2005	1372371	262754	77849	1712974	116.74
2006	1406641	264375	82046	1753062	119.47
2007	1355755	225465	90759	1671979	113.95
2008	1133068	143565	74246	1350879	92.07
2009	1413793	253706	54310	1721809	117.34
2010	1343698	224875	69287	1637860	111.62
2011	1259352	214008	81533	1554893	105.97
2012	1431946	232347	84003	1748296	119.15
2013	1584237	271907	87714	1943858	132.48
2014	1492839	248965	97225	1839029	125.33
2015	1486568	255223	109200	1850991	126.15
2016	1896479	346001	98175	2340655	159.52
2017	1764638	329524	103680	2197842	149.79
2018	1527588	227494	95852	1850934	126.14
2019	1682549	291373	96672	2070594	141.12
2020	2052685	333405	95066	2481156	169.10
2021	1787348	276619	127974	2191941	149.39

Kaynak: www.tuik.gov.tr

3.2.3. Türkiye’de Kimyasal Gübre Dış Ticareti

Türkiye’nin kimyasal gübre üretimi tüketimi karşılamakta yetersiz olduğu için, ihtiyacımız daha çok ithalat yoluyla karşılanmaktadır. 2001-2020 yılları arasında gübre ihracatımız ve ithalatımızda dalgalanmaların olduğu görülmektedir. Toplam kimyasal gübre ihracatımızın yaklaşık iki katı kadar ithalat gerçekleştirilmiştir. 2020 yılında yaklaşık 961 bin ton gerçekleştirdiğimiz kimyasal gübre ihracatımızda en fazla payı %38.76 ile azotlu gübreler oluşturmaktadır (Tablo 12). Türkiye genelinde toplam kimyasal gübre ihracatı 2001 yılına göre %322.55 oranında artmıştır. Türkiye’nin kimyasal gübre ihracatı diğer ülkelere göre oldukça düşüktür. Bunun da en önemli nedenleri; iç pazara yönelik ürün üretilmesi, hammadde kaynağında dışa bağımlılık, üretim maliyetlerinin yüksekliği ve özellikle de azotlu gübrelerde ihracatçı ülkelerle rekabet edebilme şansının bulunmamasıdır (Konyalı, 2016). Ayrıca Türkiye’de amonyum sülfat, kalsiyum amonyum nitrat, amonyum nitrat ve üre gübrelere üretiliminin iç talebi karşılayacak düzeyde olmaması ve diğer gübreler için doğal gaz, fosfat kayası, potasyum ve kükürt gibi ana girdilerin ucuz ve kolay bulunamaması zengin hammadde kaynakları bulunan ülkelerle rekabet edilememesi nedeniyle ihracat olanakları kısıtlıdır (İnal ve ark.,2020).

2020 yılında gerçekleşen 2.5 milyon ton kimyasal gübre tüketiminin %68’i (1.7 milyon ton) ithal edilmiştir. 2001-2020 yılları arasında kimyasal gübre ithalatımız %154.26 oranında artmıştır. İthalatı gerçekleştirilen kimyasal gübreler içerisinde %86.07 ile azotlu gübreler en fazla paya sahiptir. Kimyasal gübreler arasında aynı dönemler arasında ithalatında oransal olarak en fazla artış sağlanan gübre fosforlu gübreler olmuştur.



Tablo 12: Türkiye'nin Yıllara Gör Kimyasal Gübre İhracatı ve İthalatı

Yıllar	Azot		Fosfor		Potasyum		TOPLAM (NPK)	
	İhracat (ton)	İthalat (ton)	İhracat (ton)	İthalat (ton)	İhracat (ton)	İthalat (ton)	İhracat (ton)	İthalat (ton)
2001	40346	661539	208607	11603	49007	4337	297960	677479
2002	76832	740506	160170	37965	95797	11557	332799	790028
2003	32290	881177	243663	12815	107342	5216	383295	899208
2004	67730	1037843	361690	9225	125679	4026	555099	1051094
2005	45284	1013255	427312	14244	129287	9793	601883	1037292
2006	47906	1165619	310275	21478	110216	850	468397	1187947
2007	47559	1102085	225616	78845	153299	4321	426474	1185252
2008	65452	961102	175414	51123	105234	8420	346100	1020645
2009	50008	1290523	310745	71217	80806	3883	441560	1365623
2010	104965	1078662	220428	138142	102935	4054	428327	1220857
2011	111686	974341	248984	67220	107629	4821	468298	1046381
2012	76837	997475	273128	51299	106335	5942	456300	1054715
2013	81282	1404946	334261	68110	118398	11621	533941	1484677
2014	136756	1507058	348583	132536	137090	8866	622429	1648460
2015	116311	1237717	324354	106641	175499	10382	616163	1354740
2016	91015	1526486	514499	87437	150366	13269	755879	1627192
2017	186247	1761991	450178	81773	167783	14876	804208	1858640
2018	241068	1391751	289699	105683	168550	14177	699316	1511611
2019	352218	1694106	452633	132882	178629	34228	983481	1861215
2020	372515	1452332	360249	205548	228299	29469	961063	1687349
İndeks(2001=100)								
2001	100.00	100.00	100.00	100.00	100.00	100.00	100.00	100.00
2002	190.43	111.94	76.79	327.2	195.48	266.47	111.69	116.61
2003	80.04	133.2	116.8	110.44	219.03	120.28	128.64	128.07
2004	167.87	156.88	173.38	79.51	256.45	92.83	186.3	141.54
2005	122.24	153.17	204.84	122.76	263.81	225.8	202.00	134.23
2006	118.74	176.19	148.74	185.11	224.89	19.59	157.20	149.21
2007	117.88	166.59	108.15	679.53	312.81	99.65	143.13	142.74
2008	162.23	145.28	84.09	440.6	214.73	194.14	116.16	128.95
2009	123.95	195.08	148.96	613.78	164.89	89.54	148.19	167.42
2010	260.16	163.05	105.67	1190.57	210.04	93.47	143.75	139.79
2011	276.82	147.28	119.36	579.33	219.62	111.15	157.17	130.22
2012	190.45	150.78	130.92	442.12	216.98	137	153.14	136.05
2013	201.46	212.38	160.23	587.01	241.59	267.94	179.20	176.53
2014	338.96	227.81	167.1	1142.25	279.74	204.43	208.89	165.40
2015	288.28	187.09	155.49	919.08	358.11	239.39	206.79	141.08
2016	225.59	230.75	246.63	753.57	206.82	305.94	253.68	170.10
2017	461.62	266.35	215.8	704.76	342.36	342.99	269.90	172.59
2018	597.50	210.38	138.87	910.82	343.93	326.89	234.70	144.88
2019	872.99	256.09	216.97	1145.23	364.49	789.21	330.07	178.31
2020	923.30	119.54	172.69	1771.51	465.85	679.48	322.55	154.26

Kaynak: www.fao.org

Şekil 3 incelendiğinde Türkiye'nin azotlu gübre ithalatında en fazla payı Mısır (%42) oluşturmaktadır. Çin, İran ve Rusya diğer önemli ithalat yaptığımız ülkelerdir. 2021 yılında azotlu gübre ihracatımızda İspanya (%16), Ukrayna (%14) ve Fas (%12) en çok ihracat gerçekleştirdiğimiz ülkelerdir.

Fosforlu gübre ithalatımızda en fazla ithalat yaptığımız ülkeler İran (%73), Mısır (%12) ve Bulgaristan (%8)'dir (Şekil 4). Türkiye fosforlu gübre ihracatının tamamına yakını İran ve Ukrayna'ya gerçekleştirmektedir. Tradmap verilerine göre 2021 yılında Türkiye İran'a 6.7 bin ton ve Ukrayna'ya 6.6 bin ton fosforlu gübre ihracatı gerçekleştirmiştir.



Şekil 5’de Türkiye’nin potasyumlu gübrede en fazla ihracat ve ithalat yaptığı ülkeler verilmiştir. Potasyumlu gübrede en fazla ithalat gerçekleştirdiğimiz ülkeler Belarus (%57), İsrail (%16), Ürdün (%7) ve Rusya (%7)’dir. 2021 yılında potasyumlu gübre ihracatımızda en fazla payı Belçika (%62) oluşturmaktadır. Türkmenistan, Yunanistan ve Gürcistan diğer önemli ihracat yaptığımız ülkelerdir.

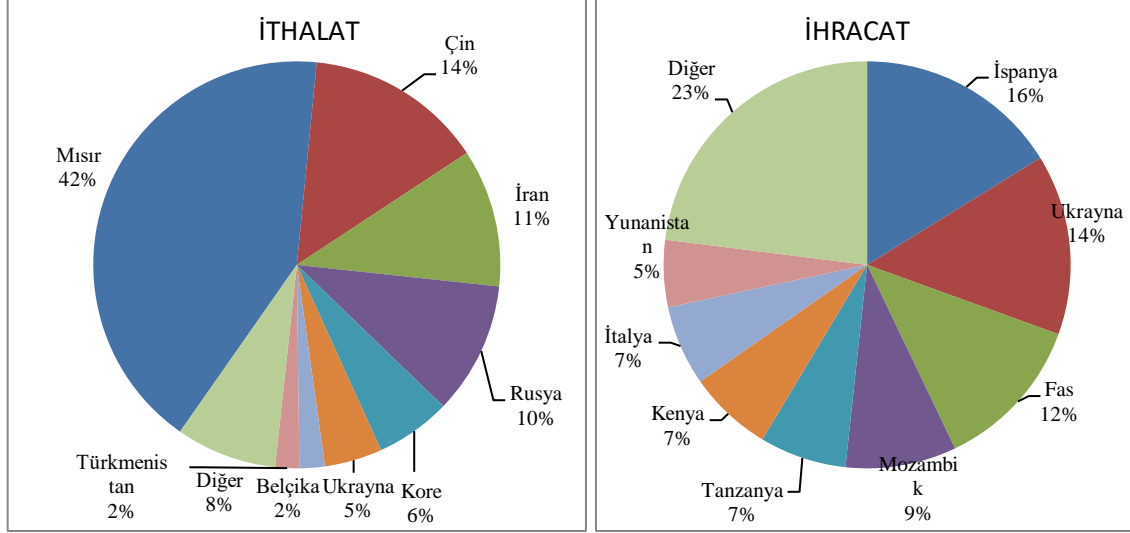

Şekil 3: Türkiye'nin En Fazla Azotlu Gübre İthalatı ve İhracatı Yaptığı Ülkeler (2021)

Kaynak: www.tradmap.com

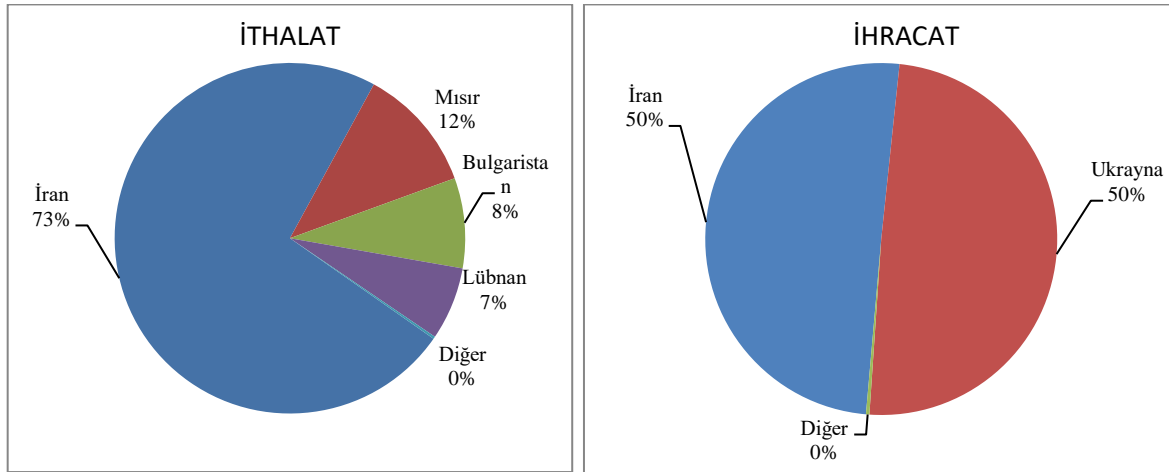

Şekil 4: Türkiye'nin En Fazla Fosforlu Gübre İthalatı ve İhracatı Yaptığı Ülkeler (2021)

Kaynak: www.tradmap.com

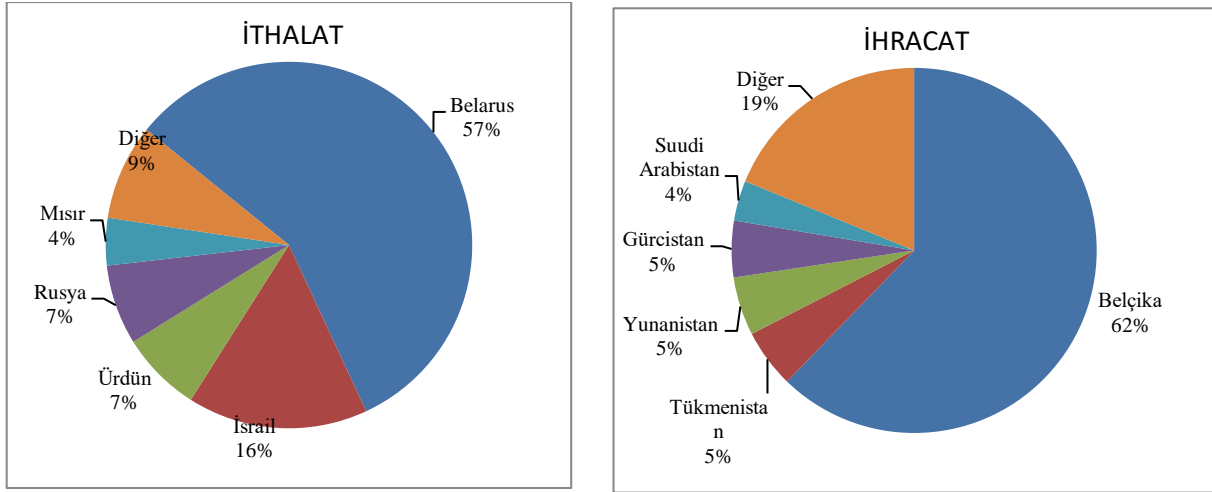

Şekil 5: Türkiye'nin En Fazla Potasyumlu Gübre İthalatı ve İhracatı Yaptığı Ülkeler (2021)
Kaynak: www.tradmap.com

3.3. Türkiye'deki Gübre Desteklemeleri

Türkiye'de birim alanda gübre tüketiminin istenilen düzeyde olmaması ve 1974 yılında yaşanan petrol krizi nedeniyle gübre fiyatlarında artış yaşanması sonucu gübrede ilk defa destekleme uygulamasına başlanmıştır. 1974-1986 yılları arası gübre cinslerine göre belirlenen maktu miktarlar üzerinden destekleme yapılmıştır. Ancak, bu destekleme yöntemi, finansman sıkıntısı ve yapılan usulsüzlükler nedeniyle uygulamadan kaldırılmıştır. (TAGEM,2018).

1994 yılında KDV'li gübre fiyatlarının belirli oranda desteklenmesi uygulamasına geçilmiş, ancak uygulamada yaşanan zorluklar ve yapılan usulsüzlüklerin kamuoyuna yansımaları nedeniyle 1997 yılında iptal edilmiştir. 2005 yılında çiftçi kayıt sisteminde kayıtlı çiftçilere yetiştirdikleri ürün gruplarına göre çiftçi başına arazi büyüklüğü 500 dekarı geçmemek kaydıyla dekar başına gübre desteği verilmeye başlanmıştır (Narin, 2008). Bu kapsamda 2018-2022 yılları arasında dekar başına ödenecek kimyasal gübre destek miktarları Tablo 13'de verilmiştir. 2018 yılında tüm ürün gruplarında 4 TL/ da olan gübre desteğinin, 2019 yılından sonra buğday, arpa, çavdar, yulaf ve trikale ürün grubunda %100 arttığı görülmektedir. Pandeminin de etkisiyle özellikle ülkelerin tahıl ürünlerine ihtiyacının artış göstermesi, bu ürün grubundaki ürünlerin üretiminin teşvik edilmesini sağlamak amacıyla destek miktarı da büyük oranda artmıştır. 2022 yılında aynı ürünler için verilecek destek miktarı 46 TL/ da iken, diğer ürünler için 21 TL/da olarak açıklanmıştır. Verilen gübre desteği çiftçinin gübre masrafının %15'ini karşılayabilecek düzeydedir.



Tablo 13: Yıllara Göre Ürün Grubu Gübre Birim Destek Miktarı

Ürünler	Gübre Desteği(TL/da)				
	2018	2019	2020	2021	2022
Buğday, Arpa, Çavdar, Yulaf, Tritikale	4	8	8	20	46
Çeltik, Kütlü Pamuk	4	4	4	8	21
Aspir	4	4	4	8	21
Kolza	4	-	-	8	21
Nohut, Kuru Fasulye, Mercimek	4	4	4	8	21
Patates, Soya	4	4	4	8	21
Yağlık Ayçiçeği	4	4	4	8	21
Dane Mısır	4	4	4	8	21
Kuru Soğan, Kanola Yaş Çay, Fındık, Yem Bitkileri	4	4	4	8	21
Zeytin	4	4	4	8	21
Diğer Ürünler	4	4	4	8	21
Nadas	-	-	-	-	-

Kaynak: T.C. Strateji ve Bütçe Başkanlığı, Yıllık Programlar

Şekil 6'da 2017-2022 yılları arasında Tarımsal destekleme bütçesinde gübre desteklemeleri için ayrılan bütçe miktarları verilmiştir. 2017 yılında 805 milyon TL olan gübre destek bütçesi toplam tarımsal desteklemeleri içinde %6.3 pay oluşturmuştur. 2021 yılında 1601 milyon TL ve %11.9 pay oluşturan gübre destek bütçesinin 2022 yılında 1599 milyon TL'ye çıkararak %12'lik pay oluşturduğu görülmektedir. Özellikle 2020 yılından sonra, dışa bağımlı olduğumuz kimyasal gübre fiyatlarındaki artış ve küresel ekonomik kriz nedeniyle gübre destek bütçesinde miktar ve oransal olarak ciddi artışın yapıldığı görülmektedir.

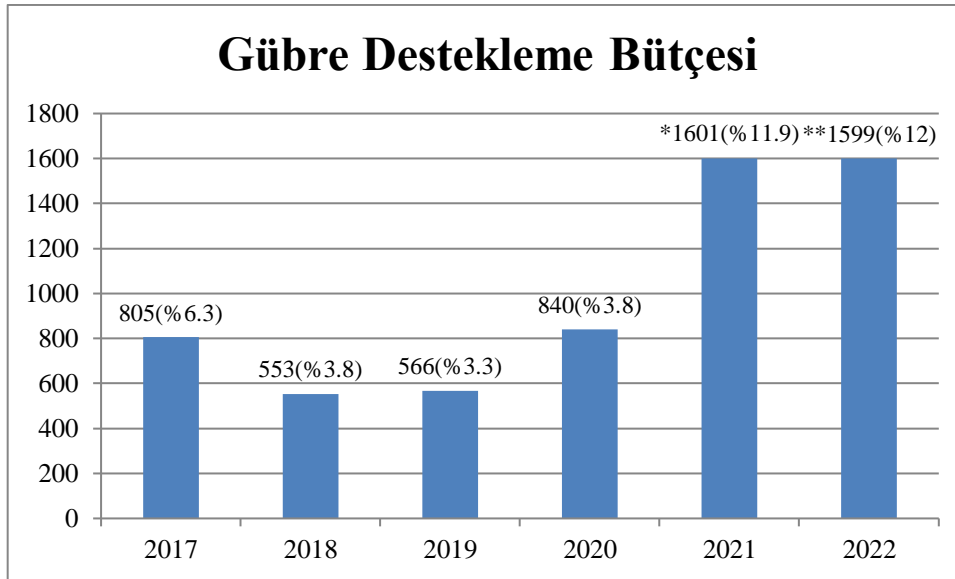

Şekil 6: Yıllara Göre Gübre Destek Bütçesi (Milyon TL)

Kaynak: T.C. Strateji ve Bütçe Başkanlığı, Kalkınma Planları

SONUÇ VE ÖNERİLER

Dünya nüfusunun artması ile birlikte, insanların beslenme ihtiyaçlarının karşılanması için, daha fazla tarım ürününün üretilmesi gerekmektedir. Bu nedenle birim alandan daha fazla ürün alınabilmesinde gübre kullanımı önem taşımaktadır. Gıda ihtiyacının karşılanmasında, daha fazla tarım ürünü alabilmek için çiftçiler gübre bakımından uzun yıllardır desteklenmektedir. Ancak kimyasal gübre kullanımının çevreye ve toprağa yaptığı olumsuz etkiler de dikkate alınmalıdır.



Kimyasal gübre (NPK) kullanımında azotlu gübre dünyada olduğu gibi ülkemizde de en fazla kullanılan gübredir. Ancak kimyasal gübre tüketiminde azotlu gübreler dünyada %56.48 pay oluştururken, Türkiye’de bu oran %81.54 ile oldukça yüksek seviyededir. Ülkemizde belirli bazı bölgeler hariç topraklarımızın organik madde bakımından genel olarak yetersiz olması nedeniyle bitkisel üretimde büyük oranda azot açığı bulunmaktadır. Bu nedenle kimyasal azotlu gübre tüketimindeki artışın önümüzdeki yıllarda da artarak devam etmesi muhtemel görünmektedir (Polat, 2020). Türkiye’de en az potasyumlu gübre tüketilmektedir.

Türkiye kimyasal gübre ihtiyacının çoğunu ithalat yoluyla karşılamaktadır. Özellikle kimyasal gübre üretiminde önemli girdilerden olan doğal gazda dışa bağımlı olmamız üretimimizi kısıtlamaktadır. Döviz kurlarında meydana gelen dalgalanmalar gübre fiyatlarını olumsuz etkileyerek, çiftçilerimizin üretim maliyetlerini de olumsuz etki oluşturmaktadır. Bunun için yurtiçinde kimyasal gübre üretim potansiyelimiz belirlenmeli ve arttırıcı önlemler alınmalıdır. Kimyasal gübre üretiminde yetersiz olmamız nedeniyle dış pazarda da payımız oldukça düşüktür.

Çiftçilerimize verilen kimyasal gübre desteklemelerinde toprak analizinin zorunlu olmayışı, bilinçsiz gübre kullanımına neden olmaktadır. Bu konuda desteklemelerde toprak analizinin zorunlu kılınması, ihtiyaca uygun gübre kullanımının sağlanmasına yardımcı olacaktır.

Kimyasal gübre kullanımındaki artış, tarımsal verimliliğin artırılmasına olanak sağlasa da, gelecek için bilinçli gübre kullanımı yönünde çiftçilerimiz eğitilmesi, akıllı gübre, organik gübre gibi çevre dostu ürünlerin benimsenmesi için teşvik edici politikalar planlanmalıdır.

KAYNAKÇA

Anonim 2008. T.C.Başbakanlık Devlet Planlama Teşkilatı Müsteşarlığı. 9.Beş Yıllık Kalkınma Planı(2007-2013).

Birleşmiş Milletler Gıda ve Tarım Örgütü (FAO). (2022). Dünya Gübre Kullanım İstatistikleri. Erişim linki: <https://www.fao.org/faostat/en/#data/RFN>

Devlet Planlama Teşkilatı (DPT) 2000. Gübre Sanayii Özel İhtisas Komisyonu Raporu. Sekizinci Beş Yıllık Kalkınma Planı. DPT:2514-ÖİK:531. Ankara.

Eyüpoğlu F 1992. Türkiye’de Kullanılan Ticaret Gübrelerinin Fiziksel ve Kimyasal Özellikleri. T.C. Tarım ve Köyişleri Bakanlığı. Köy Hizmetleri Genel Müdürlüğü. Toprak ve Gübre Araştırma Enstitüsü Müdürlüğü. Genel Yayın No: 186. Rapor Seri No: R.104. Ankara.

Eyüpoğlu F 2002. Türkiye Gübre Gereksinimi Tüketimi ve Geleceği. T.C. Tarım ve Köyişleri Bakanlığı. Köy Hizmetleri Genel Müdürlüğü. Toprak ve Gübre Araştırma Enstitüsü İşletme Müdürlüğü Yayınları. Teknik Yayın No: T-2. Genel Yayın No:2. Ankara.

Ilgar R 2020. Gübreler ve Çanakkale’deki Kullanımı. Avrasya Sosyal ve Ekonomi Araştırmaları Dergisi, 7(12): 1-16.

International Trade Centre (ITC), TRADE MAP 2022. Türkiye Gübre İthalatı ve İhracatı. Erişim Linki: https://www.trademap.org/Country_SelProductCountry_TS.aspx?nvpm

İnal Eraslan F, Güneş A, İnal A, Küçükyumuk Z, Esetlili Çolak B 2020. Gübre Üretim ve Tüketimde Mevcut Durum ve Gelecek. Türkiye Ziraat Mühendisliği IX. Teknik Kongresi. Bildiriler Kitabı-II. 13-17 Ocak 2020. 435-452.

Katip A 2020. Kimyasal Gübre Tüketiminin Değerlendirilmesi: Bursa İli Örneği. Uludağ Üniversitesi Mühendislik Fakültesi Dergisi, 25(3): 1271-1286.



INTERNATIONAL ASIAN CONGRESS ON CONTEMPORARY SCIENCES – VII

- Konyalı S 2016. Türkiye’de Gübre Üretimi ve Uygulanan Politikalar. 12. Tarım Ekonomisi Kongresi. Cilt:3: 2041-2048.
- Narin M 2008. Türkiye’de Uygulanan Tarımsal Destekleme Politikalarında Değişim. Ekonomik Yaklaşım, 19(Special): 183-225.
- Olhan E 2000. Türkiye’de Gübre Destekleme Uygulamaları DergiPark İstanbul Üniversitesi İktisat Fakültesi Mecmuası, 47: 1-4.
- Polat H 2020. Türkiye’de Kimyasal Azotlu Gübre Tüketim Durumunun ve Toprak Analizi Zorunluluğunun Azotlu Gübre Kullanımına Etkilerinin Değerlendirilmesi. Toprak Su Dergisi, 9(2): 60-71.
- Tarımsal Araştırmalar ve Politikalar Genel Müdürlüğü (TAGEM) 2018. Gübre Sektör Politika Belgesi 2018-2022. Ankara.
- T.C. Strateji ve Bütçe Başkanlığı. 2017,2018,2019,2020,2021,2022 Yılları Kalkınma Planları.
- Türkiye İstatistik Kurumu (TÜİK) 2021. Türkiye Tarımsal Gübre İstatistikleri, Kimyasal Gübre Kullanımı. Erişim Linki: <https://data.tuik.gov.tr/Kategori/GetKategori?p=tarim-111&dil=1>



PEDAQOJİ TƏHSİLİN MƏZMUN VƏ TEXNOLOGİYALARININ MƏRHƏLƏLİ TƏŞKİLİNİN YENİ MODELİ VƏ ƏLDƏ EDİLMİŞ NƏTİCƏLƏR

Afet Suleymanova

Dr., Ministry of Science and Education of the Republic of Azerbaijan, Department of content, teaching and assessment in general education, Baku, Azerbaijan
Khazar University, School of Humanities, Education and Social sciences, Baku, Azerbaijan

Xülasə

Bu tədqiqatda məqsəd müəllim hazırlığının təşkilinin səmərəliliyini yüksəltmək baxımından işlənmiş məzmun və texnologiyaların mərhələli təşkilinin yeni modelinin 2009-2017-ci illərdə tətbiqindən əldə edilən nəticələrin təhlilindən, həmin modelin əhəmiyyətlik səviyyəsinin dəyərləndirilməsindən ibarətdir. 270 saatı əhatə edən proqram üzrə dörd semestr ərzində tədris edilən eksperimental fənnin müəllim hazırlığına təsirini öyrənmək üçün Quizi-eksperimental tədqiqat növündən istifadə edilmişdir. Bu tədqiqat növü keçmişdə həyata keçirilmiş eksperimentin nəticələrinin səbəblərinin öyrənilməsi baxımından əhəmiyyətli hesab edilmişdir. Statistik əhali eksperimental fənn tətbiq edilən ali təhsil müəssisələrinin müəllimlərin işə qəbulu (MİQ) imtahanlarında iştirak edən 10360 nəfər məzundur. “Səbəb-qarşılaşdırma” metodunun “müdaxilənin nəticələrinin tədqiqi” texnikasından yararlanmaqla əldə edilmiş nəticələr belə qənaətə gəlməyə əsas verir ki, pedaqoji təhsilin məzmun və texnologiyalarının mərhələli təşkilinə əsaslanan eksperimental fənn tədris edilmiş ixtisasın məzunları MİQ imtahanlarında bu fənn tədris edilməyən ixtisasın məzunlarından bir çox hallarda yüksək nəticələr nümayiş etdirmişlər. Məlum olmuşdur ki, pedaqoji təhsilin məzmun və texnologiyaları, hətta bir fənn çərçivəsində belə 4 semestr boyu mərhələli təşkil edildikdə birincilərin yüksək nəticələr nümayişetdirmə (85,4%) imkanı ikincilərdən (48,4%) 1,76 dəfə artıqdır.

Açar sözlər: məzmun və texnologiyalar, yeni model, pedaqoji təhsil

A new model of the staged organization of content and technologies of pedagogical education and the results obtained

Abstract

The goal of this study is to assess the degree of significance of the model, which was used within the scope of the experimental subject from 2009 to 2017, and whose content and technologies were created with five stages in mind ("self-determination", "self-organization", "scientific-pedagogical organization", "self-improvement" and "self-realization").

The quiz-experimental research design was employed to investigate the impact of the experimental subject taught over four semesters on teacher training. This form of research has been deemed useful in terms of investigating the reasons of previous experiment findings. The statistical population consists of 10,360 graduates of higher education institutions who took the teacher recruitment exams, both taught and untaught experimental courses.

According to the results of the teacher recruitment exams, the results of the graduates who were taught the experimental subject based on the new model and the results of the graduates who were



not taught this subject were compared using the "investigation of the results of the intervention" technique of the "Causal comparison" method. Graduates of the privately taught experimental subject are known to show high results in many cases.

Thus, the gradual arrangement of the content and technologies of teacher education in a course covering 270 hours has made a significant difference in the results of graduates. It was determined that the results of the graduates who were taught the experimental subject (85.4%) were 1.76 times higher than the results of the graduates who were not taught this subject (48.4%).

Keywords: content and technologies; new model; teacher education

Cəmiyyətin maraq və ehtiyacları durmadan dəyişdikcə təhsil sisteminin də məqsəd və vəzifələri müvafiq olaraq yenilənir. Sistemin məqsəd və vəzifələrinin reallaşmasının əsas açarı dəyişən tələblərə cavab verən müəllim kadrlarıdır. Bu baxımdan, zamanın tələblərinə cavab verən təhsil sisteminin qurulması böyük əhəmiyyət kəsb edir. Respublikamızda da bu istiqamətdə ciddi araşdırmalar həyata keçirilir 2009-2011-ci illərdə Respublikanın üç ali təhsil müəssisəsində tətbiq olunmuş, tədrisi faktiki olaraq 2017-ci ilə qədər davam etdirilmiş yeni model üzrə həyata keçirilmiş eksperimentlər belə tədqiqatlardan hesab edilə bilər. Sözügedən yeni modeldə pedaqoji təhsilin məzmun və texnologiyalarının mərhələli təşkili əsas götürülmüş, "özünütəyin", "özünütəşkil", "elmi-pedaqoji təşəkkül", "özünütəkmilləşdirmə", "özünüreallaşdırma" mərhələləri əhatə edilmişdir. Eksperimental qruplarda təhsil alan tələbələrin məzun olduqdan sonra MİQ imtahanlarında əldə etdikləri nəticələr eksperimentə cəlb edilməmiş qruplardan məzun olanların nəticələri ilə qarşılaşdırılaraq statistik təhlillər aparılmışdır.

2009-2017-ci illərdə Respublikanın üç ali təhsil müəssisəsində dörd semestr boyunca tədris olunan "Təhsilin əsasları" eksperimental fənninin məzmun və texnologiyaları "özünütəyin", "özünütəşkil", "elmi-pedaqoji təşəkkül", "özünütəkmilləşdirmə" və "özünürealizə" mərhələləri gözlənilməklə tərtib edilmişdir. İlk olaraq gələcək müəllimlərdə özünütəyin səriştəsini formalaşdırmaq üçün fənnin "Təhsil fəlsəfəsi və təlim prosesi" bölməsi çərçivəsində tədris işi üzrə həyata keçirilmiş, və "müəllimlərin düşüncə tərzlərinin dəyişməsinin onların peşəkarlığının inkişafına səbəb olması"na nail olunmuşdur [McBride,2002] Bu mərhələdə "Təhsil nə üçün lazımdır?", "Onun məqsədi nədir?", "Məktəbin vəzifəsi nədir?", "Müəllimin və şagirdin təlim prosesində rolu nədən ibarətdir?", "Təlim mühiti necə olmalıdır?", "Hansı dərslər uğurlu dərslər hesab edilir?" kimi bu və ya digər suallara cavab verilir. Həmin problemlər müxtəlif təhsil fəlsəfəsi baxımından araşdırılmış, müasir tələblərə cavab verən yanaşmalar müəyyən edilmiş və "pedaqoji praktikanın ən sadə modeli və ya real forması ilə tanış ol"unmuşdur [McBride,2002]. Fənnin tədrisinin bu mərhələsində fəaliyyətlərinin əsas məqsədi gələcək müəllimin pedaqoji tərəkürünün formalaşmasına xidmət etməkdən, fərdin və cəmiyyətin ehtiyac və maraqlarının müasir təhsilin, məktəbin, kurikulumun, müəllim və şagird münasibətlərinin formalaşmasına və öz "peşəkar "mən"ini təyin etməsinə şərait yaratmaqdan ibarət olmuşdur.

İkinci, "özünütəşkil" mərhələsində fənn üzrə təhsil proqramı gələcək müəllimin "pedaqoji əmək mədəniyyəti"nin formalaşdırılması baxımından tərtib edilmişdir. Bu mərhələyə "Cəmiyyətin təhsil ehtiyacları və onların hüquqi təminatı", eləcə də "Təhsildə dövlət siyasəti" fəsiləri daxil edilmişdir. Gələcək müəllimlər tərəfindən şagird, valideyn və həmkarları ilə hüquqi baxımdan əsaslandırılmış qarşılıqlı fəaliyyətin qurulmasını təmin edən normativ hüquqi aktlar praktik tapşırıqlar üzrə öyrənilmiş, təhsil iştirakçılarının hüquq və vəzifələri araşdırılmışdır. Həmçinin Azərbaycan Respublikasının qoşulduğu müvafiq beynəlxalq hüquqi aktlar nəzərdən keçirilmiş, təhsil sahəsinin müxtəlif istiqamətləri üzrə dövlət siyasətini müəyyən edən strateji sənədlər praktik situasiyalar üzrə tədqiqatlar aparılmaqla öyrənilmişdir. Sənədlərdə vurğulanan humanistlik, demokratiklik, dünyəvilik, bərabər şərait, millilik, şəxsiyyətyönlülük, keyfiyyətlik, səmərəlilik, inteqrativlik, şəffaflıq və s. prinsiplərin rəhbər tutulmasının məktəbin və sinfin idarə edilməsində əhəmiyyəti



müəyyənləşdirilmişdir. Beləliklə, hüquqi və siyasi savadlılığı təmin olunmuş müəllimin özünütəşkili - öz fəaliyyətini sistemli, düşünülmüş şəkildə qurmaq imkanları maksimum səviyyəyə yüksəldilir. Gələcək müəllim öz sinfində mövcud vəziyyəti: maddi-texniki bazanı, şagirdlərin milli-etnik tərkibini, idraki imkanlarını, sosial, mənəvi-psixoloji, fiziki-fizioloji vəziyyətini, eləcə də valideynlərin intellektual səviyyəsi, sosial, mənəvi-psixoloji vəziyyətini araşdıraraq qarşıya çıxan biləcək problemləri proqnozlaşdırmağın yollarını öyrənmiş və *“özünün pedaqoji-peşə fəaliyyətini layihələşdirmək, həyata keçirmək və təkmilləşdirmək üçün qabiliyyətlərini inkişaf etdir”*mişdir [2]. Yəni eksperimental fənn proqramı üzrə bu bölmə gələcək müəllim təhsilin hər üç iştirakçısı ilə əməkdaşlıq şəraitində sinfin düzgün idarə edilməsinə xidmət göstərən real, işlək plan qurmaq, onları mərhələ-mərhələ həyata keçirmək, eləcə də əldə edilən nəticələri qiymətləndirmək və növbəti mərhələdə görülməli işlərlə bağlı qərarlar qəbul etmək kimi mühüm bacarıqlara yiyələnməsinə xidmət etmişdir. Gələcək müəllimlər, həmçinin müasir maliyyələşmə şəraitində müəllimin planlı və sistemli fəaliyyətinin məktəbin və pedaqoji kadrların büdcəsinə mümkün təsiri də öyrənməmiş, bu məsələlər *“Təhsilin iqtisadiyyatı”* məzmun xətti üzrə yığcam əhatə edilmişdir.

“Elmi-pedaqoji təşəkkül” fasiləsiz pedaqoji təhsilin məzmun və texnologiyalarının üçüncü mərhələsi olub, gələcəyin müəllimlərinin *“elmi-pedaqoji fəaliyyət üçün pedaqoji qabiliyyətinin inkişaf etdirilməsi”* baxımından əhəmiyyətli hesab edilmişdir. Bu mərhələdə tədris edilən məsələlər pedaqoji təhsil alan tələbələrin *“təhsil müddətində dövlət tədris proqramları ilə yaxından tanış olma”* və *“onlarla işləyə bilmə”*si [2] baxımından əhəmiyyətli hesab edilmişdir. Mərhələdə əsas məqsəd müəllimin peşə fəaliyyətində zəruri olan bilik və bacarıqlara yiyələnməsi və gələcək fəaliyyətinin istiqamətlərini dərk etməsindən ibarətdir. Təhsilin məzmununda həyata keçirilən islahatlar nəticəsində tədris proqramlarının xarakteri əsaslı şəkildə dəyişmişdir. Müasir təhsil proqramları yalnız təhsilin məzmununu deyil, həm də onun reallaşdırılması yollarını və qiymətləndirmə vasitələrini əks etdirir. Bunu nəzərə alaraq məzmunla bağlı mühüm nəzəri biliklərlə yanaşı, həm də təlimin təşkilinə verilən tələblərin gözlənilməsi, dərslərin forma və üsullarının düzgün təlim materiallarının məqsədmüvafiq seçilməsi, qiymətləndirmə vasitələrinin müəyyən edilməsi vacib hesab olunur. Bundan əlavə, kurikulumun tətbiqi üzrə əldə edilən nəticələrin təhlil edilməsi, problemlərin aşkar olunması, onları doğuran səbəblərin müəyyənləşdirilməsi, buna əsasən növbəti mərhələdə müvafiq qərarların qəbul edilməsi kimi bacarıqlar da keyfiyyəti yüksəltmək istiqamətində müəllim üçün mühüm hesab edilir. Qeyd edilən məsələlər eksperimental fənnin *“Təhsilin məzmunu (kurikulum) və onun elmi-nəzəri əsasları”* adlı dördüncü fəsilində əhatə edilmişdir. Fəsilin tədrisi müddətində auditoriya şəraitində əldə edilmiş bilik və bacarıqlar beşinci, *“Məktəbin və sinfin idarəedilməsi metodologiyası”* fəsilinin tədrisi zamanı real məktəb şəraitində ilkin passiv təcrübələrdə araşdırmalar və təhlillərin aparılması yolu ilə tətbiq olunur. Bu mərhələdə gələcək müəllimlərin bilik və bacarıqlarındakı mövcud üstünlük və boşluqları aşkar etmək, problemlərin aradan qaldırılması istiqamətində işlər aparılır. Elə həmin mərhələ çərçivəsində nəzəriyyə ilə təcrübəni əlaqələndirmək və *“öyrətmək”* peşəsinin sirlərini tamamilə əxz etməyə əsaslanan fəal təcrübə yer alır. Müəllimin fəaliyyət və funksiyalarına daxil olan bütün məsələlərin layihələşdirilməsi və həyata keçirilməsini əhatə edən təcrübələr bu mərhələdə nəzərdə tutulur [2].

Beləliklə, *“Təhsilin əsasları”* adlı eksperimental fənn çərçivəsində (1.) Təhsil fəlsəfəsi və təlim prosesi; (2.) Cəmiyyətin təhsil ehtiyacları və onların hüquqi təminatı; (3.) Təhsildə dövlət siyasəti; (4.) Təhsilin məzmunu (kurikulum) və onun elmi-nəzəri əsasları; (5.) Təhsilin metodoloji (praktik) əsasları; (6.) Təhsilin maliyyələşdirilməsi və keyfiyyətin yüksəldilməsində onun rolu” kimi fəsilər əhatə edilmişdir.

Eksperimental fənnin tədrisi bu baxımdan daha çox müstəqil tədqiqatlar aparmaqla bilik və bacarıqları əldə etmə texnologiyalarına əsaslanır. Ona görə də tələbələrin təşəbbüskarlığını, yaradıcılığını məhdudlaşdıran ənənəvi tədris texnologiyalarından imtina edilməsi, onların yaradıcı fəaliyyətinə imkan verən, tədqiqatçılıq bacarıqlarını stimullaşdıran dərslərə geniş yer verilməsi daha məqsəduyğundur. Yeni pedaqoji texnologiyaları və müasir təlim yanaşmalarını əks etdirən dərslərin üstünlük təşkil etməsi, təlim prosesində öyrənənin məsuliyyətini və müstəqilliyini artıran



müxtəlif iş formalarından (kollektiv iş, qruplarla iş, cütlərlə iş, fərdi iş) istifadə olunması da keyfiyyətin artırılmasına zəmin yaradır.

Təlim prosesində dialoqa, məntiqi və tənqidi təfəkkürün inkişafına, yaradıcı fəaliyyətə əsaslanan interaktiv metodlara üstünlük verilməlidir. Bununla da sərbəst düşünmə üçün real imkanlar açıla, pedaqoji prosesi tədqiqat prosesinə çevirmək olar. Təcrübə göstərir ki, öyrənənlərin onlara təqdim edilən hazır məlumatları yadda saxlamaqla deyil, həm kəmiyyət, həm də keyfiyyət tədqiqatları aparmaqla təlimə cəlb edilməsi daha məqsədmüvafiqdir. Bunun üçün kəmiyyət tədqiqatlarının diskriptiv, korelyasiya, səbəb-müqayisə və eksperimental üsulları yeri gəldikcə, məqsəduyğun şəkildə tətbiq edilməlidir. İlk məlumatların tətbiqi, təhlili və sintezi yolu ilə zəruri məlumatları toplayıb, onlarla bağlı mühakimələr yürüdərək pedaqoji təhsildə nəzərdə tutulan məzmunun mənimsənilməsi də vacib amildir. Bunun üçün aşağıdakı təlim strategiyalarından istifadə edilə bilər: məlumat bazalarından (kitabxana və İnternet) məqsədyönlü istifadə; problem həlli; tədqiqat; hadisənin (video, audio, mətn) araşdırılması; müzakirə; tədqiqatların nəticələrinin təqdim edilməsi; dərslər müşahidələri və məktəblərdə görüşlər; məsləhət **saatları**; müstəqil oxu və s.

Təlimin məqsədin reallaşdırılmasına xidmət edən forma və üsullarının seçilməsi yanaşı, öyrənənlərin tədqiqat imkanlarının daha da genişləndirilməsi, məlumat bazalarının zənginləşdirilməsi məqsədi ilə əhəmiyyətli hesab edilən əsərlərin elektron versiyasının təhsilçilərə təqdim edilməsi vacib amildir. Müxtəlif müşahidələr aparmaq, təhlil etmək, müzakirələrdə iştirak etmək, mühakimələr yürütmək məqsədi ilə uğurlu və nöqsanlı elektron dərslər nümunələrinin tədris vəsaitlərinin sırasına daxil edilməsi keyfiyyətin artırılmasına təsir edir.

Eksperimental fənnin tədrisinin səmərəliliyini artırmaq üçün ali təhsil müəssisələrində müvafiq fənn kabinetinin yaradılması, otaqların 2 tələbəyə 1 kompüter olmaqla təchiz olunması və onların İnternetə çıxışının təmin edilməsi vacib şərtlərdəndir. Çünki tədqiqatlar aparmaq, elektron məlumat bazalarından məlumatlar əldə etmək, nəticələri ilə bağlı təqdimatlar və hesabatlar hazırlamaq hər bir təhsilçilərin İKT-nin fəal istifadəçisinə çevrilməsinə yardımçı olur.

2013-2017-ci il pedaqoji kadr hazırlığı ilə məşğul olan ali təhsil müəssisələrinin məzunlarının Təhsil Nazirliyində MİQ imtahanının nəticələri baxımdan təhlil edilmişdir. 2013-cü ildən 2017-ci ilə qədər məzmun və texnologiyaları mərhələli təşkil edilmiş eksperimental fənn üzrə kurs almış “İbtidai sinif müəllimliyi” ixtisası üzrə bakalavriat səviyyəsinin nəticələri bu kursu almamış digər ixtisaslar üzrə həmin illərin məzunlarının nəticələri ilə qarşılaşdırılmışdır. Qarşılaşdırma zamanı 2013-2017-ci illərdə məzunların 5 illik nəticələrinin MİQ imtahanında

aşağıda qeyd parametrlər üzrə nəticələri əsas götürülmüşdür:

1. “36 və daha artıq bal toplayanlar” statistik göstəricilərinə əsasən eksperimental fənn **tədris edilən** ali təhsil müəssisələrinin “İbtidai sinif müəllimliyi” ixtisasının məzunları ilə bu fənn tədris edilməyən digər ixtisas məzunlarının nəticələrinin qarşılıqlı müqayisəsi;
2. “36 və daha artıq bal toplayanlar” üzrə statistik göstəricilərinə əsasən eksperimental fənn **tədris edilməyən** ali təhsil müəssisələrinin “İbtidai sinif müəllimliyi” ixtisasının məzunları ilə bu fənn tədris edilməyən digər ixtisas məzunlarının nəticələrinin qarşılıqlı müqayisəsi
3. “48 və daha artıq bal toplayanlar” üzrə statistik göstəricilərinə əsasən eksperimental fənn **tədris edilən** ali təhsil müəssisələrinin “İbtidai sinif müəllimliyi” ixtisasının məzunları ilə bu fənn tədris edilməyən digər ixtisas məzunlarının nəticələrinin qarşılıqlı müqayisəsi
4. “48 və daha artıq bal toplayanlar” üzrə statistik göstəricilərinə əsasən eksperimental fənn **tədris edilməyən** ali təhsil müəssisələrinin “İbtidai sinif müəllimliyi” ixtisasının məzunları ilə bu fənn tədris edilməyən digər ixtisas məzunlarının nəticələrinin qarşılıqlı müqayisəsi

1. Eksperimental fənn tədris edilən Azərbaycan Dövlət Pedaqoji Universitetini, Azərbaycan Müəllimlər İnstitutunu (hazırda müstəqil ali təhsil müəssisəsi kimi fəaliyyət göstərmir, ADPU –ya birləşdirilmişdir) və Gəncə Dövlət Universitetinin “İbtidai sinif müəllimliyi” ixtisasını bitirən məzunların bu fənn tədris edilməyən digər ixtisasların məzunlarının 5 illik (2013-2017) nəticələri MİQ imtahanında “36 bal və daha artıq nəticələr” parametri üzrə qarşılıqlı müqayisə edilmişdir.



Əsas məqsəd dörd semestri əhatə edən bir fənn çərçivəsində pedaqoji təhsilin məzmun və texnologiyalarının imkanlarının pedaqoji kadr hazırlığına verilən tələblər baxımından dəyərləndirilməsidir. Müqayisələrin nəticələri şəkil 1- də təqdim edilmişdir:

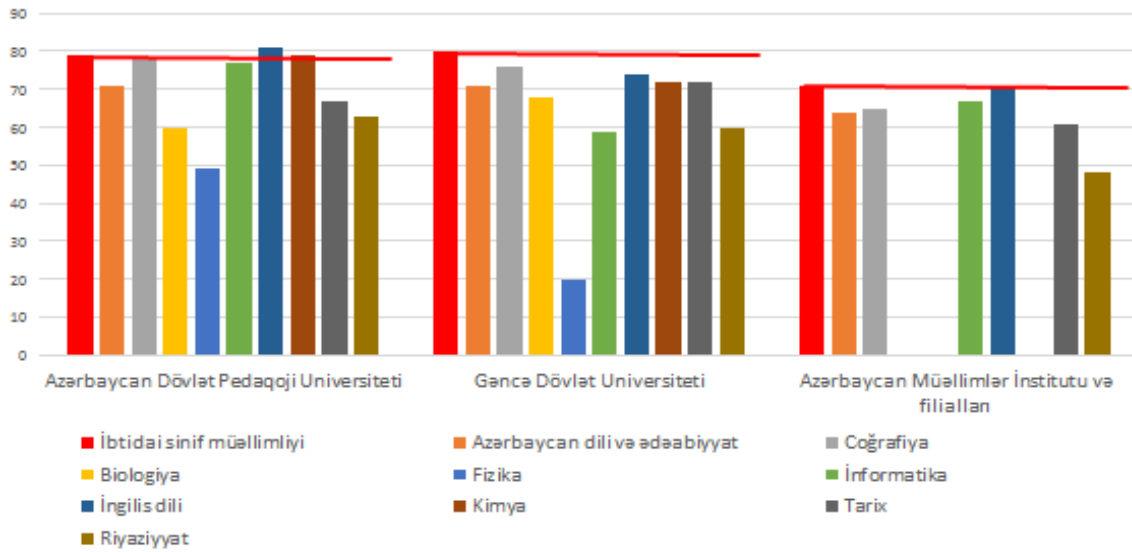

Şəkil 1

“36 və daha çox bal toplayanlar” parametri üzrə ADPU, GDU, AMİ –də eksperimental fənn tədris edilmiş ibtidai sinif müəllimliyi ixtisas məzunları ilə həmin fənn tədris edilməyən digər ixtisas məzunlarının beş illik nəticələrin müqayisəsi
Şəkil 1.-ə dair Cədvəl 1.

	Eksperimental fənn üzrə təhsil almış qruplar	Eksperimental fənn üzrə təhsil almamış qruplar								
		İbtidai sinif müəllimliyi	Azərbaycan dili və Ədəbiyyatı müəllimliyi	Coğrafiya müəllimliyi	Biologiya müəllimliyi	Fizika müəllimliyi	İnformatika müəllimliyi	İngilis dili müəllimliyi	Kimya müəllimliyi	Tarix müəllimliyi
Azərbaycan Dövlət Pedaqoji Universiteti	79	71	78	60	49	77	81	79	67	63
Gəncə Dövlət Universiteti	80	71	76	64	20	59	74	72	72	60
Azərbaycan Müəllimlər İnstitutu və filialları	71	64	65			67	71		61	48

Şəkildən göründüyü kimi, ADPU-nun məzunları “İngilis dili müəllimliyi” ixtisası üzrə 2% daha yüksək, “Kimya müəllimliyi” ixtisası üzrə 79% olmaqla bərabər nəticə göstərmiş, “Azərbaycan dili və ədəbiyyat müəllimliyi” ixtisası üzrə 8%, “Coğrafiya müəllimliyi” ixtisası üzrə 7%, “Biologiya müəllimliyi” ixtisası üzrə 19%, “Fizika müəllimliyi” ixtisası üzrə 30%, “İnformatika” müəllimliyi ixtisası üzrə 2%, “Tarix” müəllimliyi” ixtisası üzrə 12%, “Riyaziyyat müəllimliyi” ixtisası üzrə isə 16% aşağı nəticə nümayiş etdirmişlər.



Gəncə Dövlət Universiteti və Azərbaycan Müəllimlər İnstitutunun “İbtidai sinif müəllimliyi” ixtisası üzrə məzunları pedaqoji kadr hazırlığının bütün digər ixtisaslarından 4-60% arasında fərqlə daha yüksək nəticələr nümayiş etdirmişlər.

Eksperimental fənn tədris edilən ali təhsil müəssisələrinin “İbtidai sinif müəllimliyi” ixtisasını bitirən məzunların və bu fənn tədris edilməyən digər ixtisasların məzunlarının 5 illik (2013-2017) nəticələrinin MİQ imtahanında “48 bal və daha artıq nəticələr” parametri üzrə qarşılıqlı müqayisəsi zamanı şəkil 2 və cədvəl 2-də təqdim olunanlar müəyyən edilmişdir.

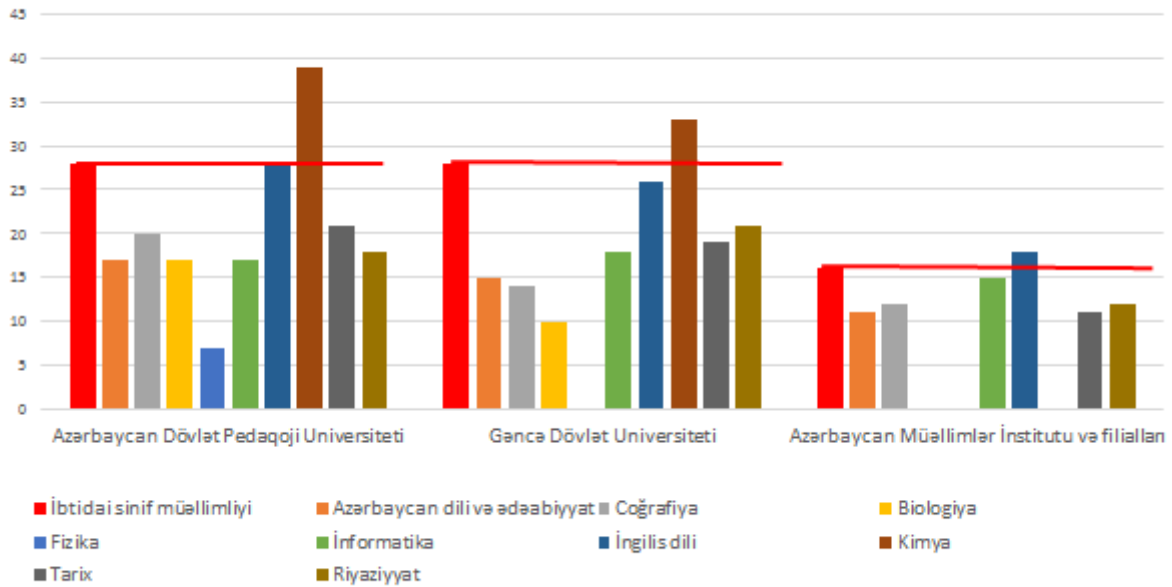

Şəkil 2

“48 və daha çox bal toplayanlar” parametri üzrə ADPU, GDU və AMİ– də eksperimental fənn tədris edilmiş ibtidai sinif müəllimliyi ixtisas məzunları ilə həmin fənn tədris edilməyən digər ixtisas məzunlarının beş illik nəticələrin müqayisəsi

Şəkil 2-yə dair Cədvəl 2

48 və daha artıq	İbtidai sinif müəllimliyi	Azərbaycan dili və Ədəbiyyatı müəllimliyi	Coğrafiya müəllimliyi	Biologiya müəllimliyi	Fizika müəllimliyi	İnformatika müəllimliyi	İngilis dili müəllimliyi	Kimya müəllimliyi	Tarix müəllimliyi	Riyaziyyat müəllimliyi
Azərbaycan Dövlət Pedaqoji Universiteti	28	17	20	17	7	17	28	39	21	18
Gəncə Dövlət Universiteti	28	15	14	10	0	18	26	33	19	21
Azərbaycan Müəllimlər İnstitutu və filialları	16	11	12			17	18		11	12

Şəkil və cədvəldən görüldüyü kimi “48 və daha artıq” parametrinə görə ADPU və “Təhsilin əsasları” fənni tədris edilən “İbtidai sinif müəllimliyi” ixtisasının məzunlarının nəticələri GDU-da “Kimya”, ADPU və AMİ -də “İngilis dili” ixtisasları istisna olmaqla bu fənn tədris edilməyən digər yeddi ixtisas üzrə məzunların nəticələrindən daha yüksəkdir.

Beləliklə, 2013-2017-ci illərdə məzunların 5 illik nəticələrinin MİQ imtahanında həm “36 bal və



daha artıq” həm də “48 bal və daha artıq” parametrlərinə görə məzmun və texnologiyaları mərhələli tətbiq edilmiş “Təhsilin əsasları” eksperimental fənni tədris edilmiş “İbtidai sinif müəllimliyi” ixtisas məzunlarının nəticələri həmin ali təhsil müəssisələrində bu fənn tədris edilməyən, digər ixtisas məzunların nəticələrindən əhəmiyyətli dərəcədə yüksək olmuşdur. olduğu aşkar edilmişdir.

“Təhsilin əsasları” eksperimental fənni tədris edilməyən Bakı Dövlət Universiteti, Sumqayıt Dövlət Universiteti, Lənkəran Dövlət Universiteti və Naxçıvan Dövlət Universitetinin “İbtidai sinif müəllimliyi” ixtisası üzrə məzunlarının və bu fənn tədris edilməyən digər ixtisaslar üzrə məzunların 5 illik (2013-2017) nəticələrinin MİQ imtahanında “36 bal və daha artıq nəticələr”, “48 bal və daha artıq” parametri üzrə qarşılıqlı müqayisəsi aparılmışdır.

Aparılmış təhlillər göstərir ki, bu parametr üzrə də məzunların nümayiş etdirdiyi nəticələrin birmənalı dəyərləndirilməsi asan deyil. Belə ki, Bakı Dövlət Universitetində “İbtidai sinif müəllimliyi” ixtisasını bitirənlər digər ixtisasların məzunlarından daha aşağı nəticə göstərdikləri halda, digər üç ali təhsil müəssisəsində “Kimya” (LDU və NDU) və “Azərbaycan dili və ədəbiyyatı” (NDU) ixtisası istisna olmaqla qalan yeddi ixtisas üzrə daha yüksək nəticə nümayiş etdirmişlər. Təhlillərin nəticələri şəkil 3-dəki kimidir:

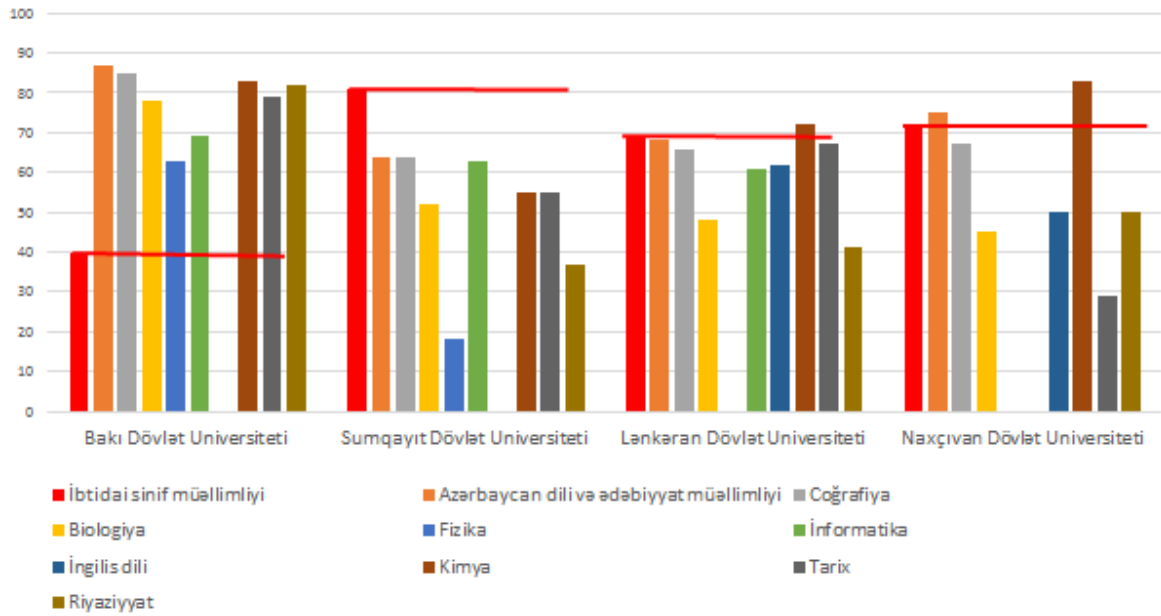

Şəkil 3.

“36 və daha çox bal toplayanlar” parametri üzrə “Təhsilin əsasları” eksperimental fənni tədris edilməmiş BDU, SDU, LDU, NDU-da “İbtidai sinif müəllimliyi” ixtisas məzunları ilə həmin fənn tədris edilməyən digər ixtisas məzunlarının beş illik nəticələrin müqayisəsi



Şəkil 3-ə dair cədvəl 3

		İbtidai sinif müəllimliyi	Azərbaycan dili və Ədəbiyyatı müəllimliyi	Coğrafiya müəllimliyi	Biologiya müəllimliyi	Fizika müəllimliyi	İnformatika müəllimliyi	İngilis dili müəllimliyi	Kimya müəllimliyi	Tarix müəllimliyi	Riyaziyyat müəllimliyi
Bakı Dövlət Universiteti	Dövlət	40	87	85	78	63	69		83	79	82
Sumqayıt Universiteti	Dövlət	81	64	64	52	18	63		55	55	37
Lənkəran Universiteti	Dövlət	69	68	66	48		61	62	72	67	41
Naxçıvan Universiteti	Dövlət	71	75	67	45			50	83	29	50

Təhlillər zamanı BDU-nun “İbtidai sinif müəllimliyi” ixtisası üzrə 36 və daha artıq bal toplayan məzunların faizinin digər ixtisaslardan 24-37 faiz aşağı olması müşahidə edilmişdir. LDU-nun “İbtidai sinif müəllimliyi” ixtisasını bitirənlər eyni parametrlərdən “Kimya” ixtisası üzrə məzunlardan 3%, NDU-da isə 12% az nəticə göstərmişdir. Həmçinin NDU-nun “Azərbaycan dili və ədəbiyyatı” ixtisası üzrə məzunları “İbtidai sinif müəllimliyi” ixtisasını bitirənlərdən 4% aşağıdır. Eksperimental fənn tədris edilməyən ali təhsil müəssisələrinin “İbtidai sinif müəllimliyi” ixtisası üzrə məzunlarla bu fənn tədris edilməyən digər ixtisasları bitirənlərin 5 illik (2013-2017) nəticələrinin MİQ imtahanında “48 bal və daha artıq nəticələr” parametri üzrə qarşılıqlı müqayisəsi aparılmışdır (şəkil 4, cədvəl 4).

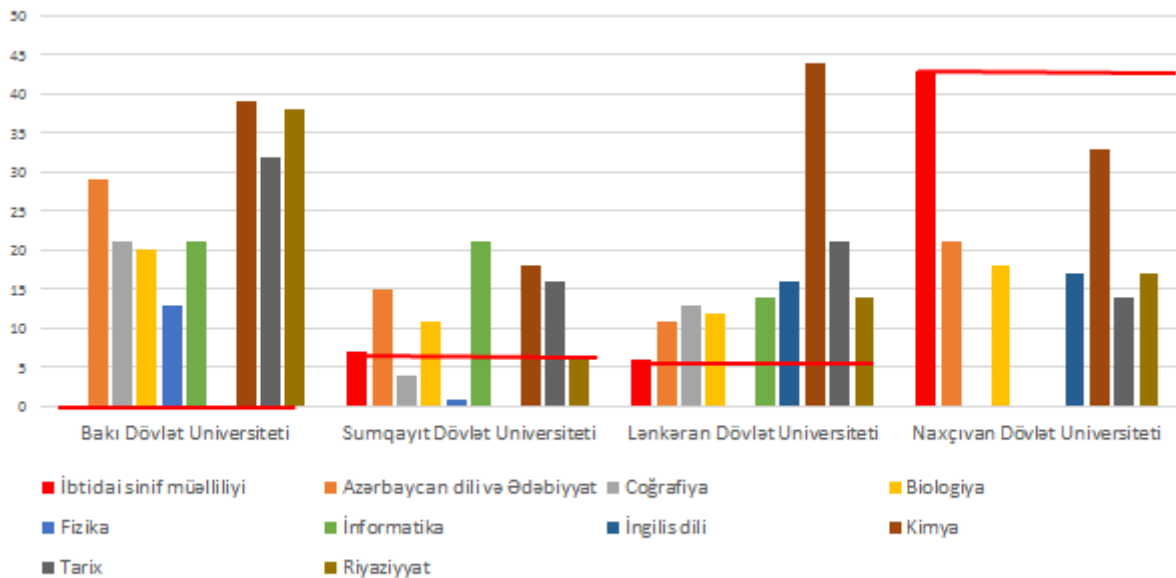

Şəkil 4.

“48 və daha çox bal toplayanlar” parametri üzrə “Təhsilin əsasları” eksperimental fənni tədris edilməmiş BDU, SDU, LDU, NDU-da “İbtidai sinif müəllimliyi” ixtisas məzunları ilə həmin fənn tədris edilməyən digər ixtisas məzunlarının beş illik nəticələrin müqayisəsi



Şəkil 4-ə dair cədvəl 4

48 və daha artıq	İbtidai sinif müəllimliyi	Azərbaycan dili və Ədəbiyyatı müəllimliyi	Coğrafiya müəllimliyi	Biologiya müəllimliyi	Fizika müəllimliyi	İnformatika müəllimliyi	İngilis dili müəllimliyi	Kimya müəllimliyi	Tarix müəllimliyi	Riyaziyyat müəllimliyi
Bakı Dövlət Universiteti	0	29	21	20	13			39	32	38
Sumqayıt Dövlət Universiteti	7	15	4	1	21			18	16	6
Lənkəran Dövlət Universiteti	6	11	13	12		14	16	44	21	14
Naxçıvan Dövlət Universiteti	43	21	0	18			17	33	14	17

Göründüyü kimi, 2013-2017-ci illərdə məzunların 5 illik nəticələrinin MİQ imtahanında “48 və daha çox bal toplayanlar” parametrinə görə BDU-nun “İbtidai sinif müəllimliyi” ixtisasının məzunları 48 bal toplaya bilməmiş, yəni bütün digər ixtisaslardan aşağı nəticə nümayiş etdirmişlər. Sumqayıt Dövlət Universitetinin “İbtidai sinif müəllimliyi” ixtisasının məzunları “Coğrafiya”, “Fizika” və “Riyaziyyat” ixtisaslarını bitirənlərin nəticələrindən 1-6 faiz arasında fərqlə yüksək nəticə göstərmişdir. Digər 5 ixtisas üzrə (“Azərbaycan dili ədəbiyyatı”, “Biologiya”, “İnformatika”, “Kimya”, “Tarix”) 8-14 faiz arasında fərqlə aşağıdır.

Lənkəran Dövlət Universitetinin “İbtidai sinif müəllimliyi”ni bitirənlər digər 8 ixtisas üzrə məzunlarla müqayisədə (“Fizika” ixtisası üzrə müsabiqədə iştirak edilməmişdir) 5-38 faiz arasında fərqlə aşağı nəticə nümayiş etdirmiş, göstəriciləri isə Naxçıvan Dövlət Universitetinin “İbtidai sinif müəllimliyi” ixtisası üzrə məzunların digər 7 ixtisas (“Fizika” və “İnformatika” ixtisaslarını bitirənlər müsabiqədə iştirak etməmişdir) məzunların nəticələrindən yüksək olduğu müəyyən edilmişdir.

Beləliklə, aparılmış təhlillərin nəticələri göstərir ki, birinci şəraitdə (“Təhsilin əsasları” fənni tədris edilən ADPU, GDU və AMİ-də) MİQ - in “36 və daha artıq” parametri üzrə nəticələrinə əsasən “İbtidai sinif müəllimliyi” ixtisası üzrə məzunlar digər ixtisas məzunları ilə müqayisədə 24 haldan 21-də (87,5%) yüksək, 2-də (8,3%) bərabər, 1 halda (4,5%) aşağı nəticə göstərmişdir.

Cədvəl 5.

“Təhsilin əsasları” fənni tədris edilən ADPU, GDU və AMİ-də) “İbtidai sinif müəllimliyi” ixtisasını bitirən məzunların MİQ-in “36 və daha artıq” parametri üzrə nəticələrinin digər ixtisas məzunlarının nəticələri ilə müqayisəsi

	İbtidai sinif müəllimliyi	Azərbaycan dili və Ədəbiyyatı müəllimliyi	Coğrafiya müəllimliyi	Biologiya müəllimliyi	Fizika müəllimliyi	İnformatika müəllimliyi	İngilis dili müəllimliyi	Kimya müəllimliyi	Tarix müəllimliyi	Riyaziyyat müəllimliyi
Müqayisə halı cəmi 24										
Azərbaycan Dövlət Pedaqoji Universiteti	79	71	78	60	49	77	81	79	67	63
Gəncə Dövlət Universiteti	80	71	76	68	20	59	74	72	72	60
Azərbaycan Müəllimlər İnstitutu və filialları	71	64	65			67	71		61	48



Eyni üsulla dəyərləndirmə “48 və daha artıq” parametri üzrə nəticələrə görə aparılmışdır. Müəyyən edilmişdir ki, “İbtidai sinif müəllimliyi” ixtisası üzrə məzunlar digər ixtisas məzunları ilə müqayisədə 24 haldan 20-də (83,3%) yüksək, 1 halda (4.1%) bərabər, 3 halda (12,5%) aşağı nəticə göstərmişdi.

Cədvəl 6.

“Təhsilin əsasları” fənni tədris edilən ADPU, GDU və AMİ-də) “İbtidai sinif müəllimliyi” ixtisasını bitirən məzunların MİQ - in “48 və daha artıq” parametri üzrə nəticələrinin digər ixtisas məzunlarının nəticələri ilə müqayisəsi

	İbtidai sinif müəllimliyi	Azərbaycan dili və Ədəbiyyatı müəllimliyi	Coğrafiya müəllimliyi	Biologiya müəllimliyi	Fizika müəllimliyi	İnformatika müəllimliyi	İngilis dili müəllimliyi	Kimya müəllimliyi	Tarix müəllimliyi	Riyaziyyat müəllimliyi
		Qiymətləndirmə halı cəmi 24								
Azərbaycan Dövlət Pedagoji Universiteti	28	17	20	17	7	17	28	39	21	18
Gəncə Dövlət Universiteti	28	16	14	10	0	18	26	33	19	21
Azərbaycan Müəllimlər İnstitutu və filialları	16	11	12			15	18		1	12

İkinci şəraitdə də (“Təhsilin əsasları” fənni tədris edilməyən BDU, SDU, LDU və NDU-da) “36 və daha çox bal toplayanlar” parametri üzrə “İbtidai sinif müəllimliyi” ixtisası məzunlarının nəticələri digər ixtisas məzunlarının nəticələri ilə müqayisədə 31 haldan 20-də (64,5%) yüksək, 11 halda (35,5%) aşağı nəticə nümayiş etdirmişlər.

Cədvəl 7

“Təhsilin əsasları” fənni tədris edilməyən BDU, SDU, LDU və NDU-da “İbtidai sinif müəllimliyi” ixtisasını bitirən məzunların MİQ -in “36 və daha artıq” parametri üzrə nəticələrinin digər ixtisas məzunlarının nəticələri ilə müqayisəsi

	İbtidai sinif müəllimliyi	Azərbaycan dili və Ədəbiyyatı müəllimliyi	Coğrafiya müəllimliyi	Biologiya müəllimliyi	Fizika müəllimliyi	İnformatika müəllimliyi	İngilis dili müəllimliyi	Kimya müəllimliyi	Tarix müəllimliyi	Riyaziyyat müəllimliyi
		Qiymətləndirmə halı cəmi 31								
Bakı Dövlət Universiteti	40	87	85	78	63	69		83	79	82
Sumqayıt Dövlət Universiteti	81	64	64	52	18	63		56	56	37
Lənkəran Dövlət Universiteti	69	68	66	48		61	62	72	67	41
Naxçıvan Dövlət Universiteti	71	75	67	45			50	83	29	50

“48 və daha artıq” parametri üzrə nəticələrə görə aparılmış eyni xarakterli dəyərləndirmələr zamanı müəyyən edilmişdir ki, “İbtidai sinif müəllimliyi” ixtisasının məzunlarının nəticələri digər ixtisas məzunlarının nəticələri ilə müqayisədə 31 haldan 10-da (32,5) yüksək, 21 halda (67,7) aşağı nəticə göstərmişdi.



Cədvəl 8

“Təhsilin əsasları” fənni tədris edilməyən BDU, SDU, LDU və NDU-da “İbtidai sinif müəllimliyi” ixtisasını bitirən məzunların MİQ -in “48 və daha artıq” parametri üzrə nəticələrinin digər ixtisas məzunlarının nəticələri ilə müqayisəsi

	İbtidai sinif müəllimliyi	Azərbaycan dili və Ədəbiyyatı müəllimliyi	Coğrafiya müəllimliyi	Biologiya müəllimliyi	Fizika müəllimliyi	İnformatika müəllimliyi	İngilis dili müəllimliyi	Kimya müəllimliyi	Tarix müəllimliyi	Riyaziyyat müəllimliyi
	Qiymətləndirmə halı cəmi 31									
Bakı Dövlət Universiteti	0	29	21	20	13	21		39	32	38
Sumqayıt Dövlət Universiteti	7	15	4	11	1	21		18	16	6
Lənkəran Dövlət Universiteti	6	11	13	12		14	16	44	21	14
Naxçıvan Dövlət Universiteti	43	21	0	18			17	33	14	17

Nəticələr cədvəl 9-da təqdim edildiyi kimi ümumiləşdirilmişdir:

Cədvəl 9. Eksperimental fənn tədris edilən və edilməyən universitetlərdə “İbtidai sinif müəllimliyi” ixtisası üzrə məzunların MİQ imtahanının nəticələrinin digər ixtisaslar bitirən məzunların nəticələri ilə müqayisəsi

36 və daha artıq bal					48 və daha artıq bal				
	24 haldan	Eksperimental fənn tədris edilən ADPU,GDU, AMİ (faizlə)	31 haldan	Eksperimental fənn tədris edilməyən BDU,SDU,LDU,NDU (faizlə)		24 haldan	Eksperimental fənn tədris edilən ADPU,GDU, AMİ (faizlə)	31 haldan	Eksperimental fənn tədris edilməyən BDU,SDU,LDU,NDU (faizlə)
Yüksək	21	87,5%	20	64,5%	Yüksək	20	83,3%	10	32,5%
Bərabər	2	8,3%	0	0	Bərabər	1	4,1%	0	0
Aşağı	1	4,5%	11	35,5%	Aşağı	3	12,5%	21	67,7%

Beləliklə, “36 bal və daha artıq”, “48 bal və daha artıq” kimi parametrlərə görə əldə edilmiş nəticələrə görə pedaqoji təhsilin məzmun və texnologiyalarının mərhələli təşkili baxımından 2009-2017-ci illərdə eksperimental “Təhsilin əsasları” fənni tətbiq edilmiş ali təhsil müəssisələrinin (ADPU, GDU və AMİ) “İbtidai sinif müəllimliyi” ixtisası üzrə məzunların nəticələri həmin fənn tədris edilməyən digər ixtisasları bitirən məzunların nəticələri ilə müqayisədə 2013-2017-ci illərdə MİQ imtahanlarında əldə etdikləri 5 illik nəticələrə görə 48 haldan (24-ü “36 və daha artıq bal”, 24-ü “48 və daha artıq bal”) 41-də (21+20) yüksək, 3 (2+1) halda bərabər, 4 (1+3) halda aşağı nəticə nümayiş etdirmişlər. Eksperimental fənn tətbiq edilməyən ali təhsil müəssisələrində (BDU, SDU,



LDU, NDU) isə 62 haldan (31-i “36 və daha artıq bal”, 31-i “48 və daha artıq bal”) 30-da (20+10) yüksək, 32 (21+11) halda aşağı nəticə göstərilmişdir. Qeyd edilənlər cədvəl 10-da təqdim edildiyi kimidir:

Cədvəl 10. Nəticələrin ümumiləşdirilməsi

	Eksperimental fənn keçilən ADPU, GDU, AMİ		Eksperimental fənn keçilməyən BDU, SDU, LDU, NDU	
	Cəmi 48 hal	Faizlə	Cəmi 62 hal	Faizlə
Yüksək	41 (21+20)	85,4%	30 (20+10)	48,4%
Bərabər	3 (2+1)	6,25%	0	0
Aşağı	4 (1+3)	8,3%	32(21+11)	51,6%

Cədvəldən görüldüyü kimi, pedaqoji təhsilin məzmun və texnologiyalarının beş mərhələsi baxımından tələblər gözlənilməklə proqramı tərtib edilmiş “Təhsilin əsasları” eksperimental fənni tədris edilmiş “İbtidai sinif müəllimliyi” ixtisasının məzunlarının nəticələri, həmin universitetlərin eksperimental fənn tədris edilməyən digər ixtisaslarının məzunlarının nəticələri ilə müqayisədə “yüksək” parametri üzrə 85,4% “bərabər” parametri üzrə 6,25%, “aşağı” parametri üzrə 8,3% faiz təşkil etdiyi müəyyənləşdirilmişdir. Nəticələrin etibarlılığını təmin etmək məqsədi ilə eksperimental fənn tətbiq edilməyən ali təhsil müəssisələrində də “İbtidai sinif müəllimliyi” ixtisası üzrə məzunların MİQ imtahanlarında 5 illik nəticələrinin digər ixtisasları bitirən məzunların nəticələri ilə müqayisəli təhlilinin nəticələrinə görə “yüksək” parametri üzrə 48,4 %, “bərabər” parametrinə görə 0%, “aşağı” parametrinə görə 51,6% təşkil etmişdir. Beləliklə, eksperimental fənn tədris edilən ali təhsil müəssisələrində eksperimental qrup olan “İbtidai sinif müəllimliyi” ixtisasının məzunları digər qruplarla müqayisədə 4 halda (8,3%), eksperimental fənn tədris edilməyən ali təhsil müəssisələrində eyni xarakterli müqayisədə isə məzunlar 32 halda (51,6%) aşağı nəticələr nümayiş etdirmişlər. Öldə edilmiş nəticələr belə qənaətə gəlməyə əsas verir ki, proqramı pedaqoji təhsilin məzmun və texnologiyalarının mərhələli təşkili əsasında hazırlanan “Təhsilin əsasları” eksperimental fənni tədris edilmiş məzunlar MİQ imtahanlarında əhəmiyyətli fərqlə yüksək nəticələr göstəriblər. Məlum olmuşdur ki, pedaqoji təhsilin məzmun və texnologiyaları, hətta bir fənn çərçivəsində (4 semestr, 270 saat) mərhələli təşkil edildikdə, daha yüksək nəticələrə nail olmaq mümkündür: 1,76 (≈ 2 dəfə) dəfə (85,4% / 48,4%)

İstifadə edilmiş ədəbiyyat

1. Azərbaycan Respublikasında fasiləsiz pedaqoji təhsil və müəllim hazırlığının Konsepsiya və Strategiyası. <http://www.e-qanun.az/framework/13540>
2. Fraenkel, J.R. (2012). How to design and evaluate research in education/ Jack Fraenkel, Norman Wallen, Helen, Hyun. — 8th ed. ISBN-13: 978-0-07-809785-0 (hardback); ISBN-10: 0-07-809785-1
3. Məkbərd, R. (2002). Beynəlxalq məsləhətçi, milli məsləhətçilər: Aydın Kazımzadə, Bəhram Şiriyev, Tərcüməçi: Aynur Balakışiyeva, Müəllim hazırlığı (pedaqoji təhsil, ixtisasartırma və yenidən hazırlanma), Yekun hesabat, Təhsil Sektorunun İnkişafı Layihəsi, Azərbaycan Respublikası Təhsil Nazirliyi.
4. Statistik materiallar
5. Süleymanova, A.Y. (2014). “Təhsilin əsasları”, Bakı, “Təhsil”, 400 səh.



TERS YÜZ EDİLMİŞ SINIF MODELİNE GÖRE YAPILAN DİL BİLGİSİ ÖĞRETİMİNE YÖNELİK ÖĞRENCİ GÖRÜŞLERİ¹

İrem Toprak Kaya

Fırat Üniversitesi Eğitim Fakültesi Türkçe Eğitimi Bölümü

Şener Demirel

Prof. Dr., Fırat Üniversitesi Eğitim Fakültesi Türkçe Eğitimi Bölümü

Özet

Ters yüz edilmiş sınıf (TYES) modeli, dersin teorik kısmının öğretmenin gönderdiği ders videoları aracılığıyla öğrenildiği; sınıf içinde ise öğretmenin vermiş olduğu etkinlik kağıtlarıyla grup içi çalışmalar yapılarak aktif öğrenmelerin sağlandığı bir modeldir. TYES modelinde öğretmen, öğrencilere kendisinin hazırladığı ya da başka bir eğitmen tarafından hazırlanmış hazır ders videolarını çeşitli platformlardan öğrencilerine gönderir. Ders aşamasına gelindiğinde ise öğretmen, öğrencilere hazırladığı etkinlik kağıtlarını dağıtır. Etkinlikler yapılırken grup içi çalışmalar yapılır ve öğrenciler işbirliği içinde çalışırlar. Böylece öğrenciler, anlamadıkları yerleri arkadaşlarına sorarak grup içi tartışmalara aktif olarak katılabilirler. Öğretmen, grupları gezerek çalışmaların takibi yapar. Öğrenciler, anlamadıkları yerleri öğretmenlerine ya da grup içindeki arkadaşlarına sorarak etkili bir öğrenme sağlarlar. Dersin sonunda dersin özeti yapıp genel bir değerlendirmeyle ders sonlandırılır. Bu araştırmanın amacı, TYES modeli ile yapılan dil bilgisi öğretimine yönelik öğrenci görüşlerini incelemektir. Çalışmanın katılımcılarını 2021-2022 eğitim ve öğretim yılında Elazığ İl Milli Eğitim Müdürlüğüne bağlı bir ortaokulun 7. sınıfında öğrenim gören 44 öğrenci oluşturmaktadır. Bu öğrencilerin 21'i deney, 23'ü ise kontrol grubunda yer almıştır. Uygulama süreci, sekiz hafta deneysel uygulama süreciyle sınırlandırılmıştır. Bu süreçte deney grubu öğrencilerine EBA aracılığıyla dil bilgisi konuları aktarılmıştır. Sınıf içinde ise aktif rol oynayabilecekleri etkinlikler yaptırılmıştır. Kontrol grubu öğrencilerine ise Türk ders kitabında yer alan dil bilgisi etkinlikleri yaptırılmış ve klasik tarzda ev ödevleri verilmiştir. Deneysel süreç sonunda öğrencilerin TYES modeli ile yapılan dil bilgisi etkinliklerine yönelik görüşlerini elde etmek amacıyla araştırmacı tarafından hazırlanan yarı yapılandırılmış görüşme kılavuzu kullanılmıştır. Deney grubunda yer alan 12 öğrenci ile görüşmeler yapılmış ve daha sonra bu veriler MAXQDA nitel veri analiz programı aracılığıyla içerik analizi yapılmıştır. Yapılan analiz sonucunda öğrenciler, TYES modelinin sınıf içinde zevkli bir sınıf oluşturduğunu, öğretmen-öğrenci ve öğrenci-öğrenci etkileşimini artırdığını; sınıf dışında ise ders videoları aracılığıyla konuyu istedikleri zaman izleyebilme, videoyu durdurup izleyebilme, sorumluluk bilinci kazandırma konusunda avantaj kazandırdığını belirtmişlerdir.

Anahtar kelimeler: Ters yüz edilmiş sınıf modeli, dil bilgisi öğretimi, fiil öğretimi

¹ Bu çalışma İrem Toprak Kaya'nın Fırat Üniversitesi Eğitim Bilimleri Enstitüsü Türkçe Öğretmenliği Anabilim dalında Prof. Dr. Şener Demirel danışmanlığında hazırlanan "Ters Yüz Edilmiş Sınıf Modelinin 7. Sınıflarda Fiil Öğretimine ve Dil Bilgisine Yönelik Tutumlarına Etkisi" adlı doktora tezinden üretilmiştir.



STUDENT OPINIONS ABOUT GRAMMAR TEACHING ACCORDING TO FLIPPED CLASSROOM MODEL²

Abstract

The flipped classroom (FCR) model is a model in which the theoretical part of the course is learned through videos sent by the teacher, and active learning is provided by conducting group studies with activity papers given by the teacher within the classroom. In the FCR model, the teacher sends ready-made course videos prepared by him/herself or by another instructor to the students via various platforms. In the actual lecturing stage, the teacher distributes the activity papers he/she has prepared to the students. While activities are being conducted, in-group studies are carried out and students work collaboratively. Thus, students can actively participate in in-group discussions by asking their friends about the parts they do not understand. The teacher tracks the studies by checking out the groups. Students achieve effective learning by asking their teachers or friends in the group about the parts they don't understand. At the end of the lecture, the course summary is made and the course is terminated with a general assessment.

The aim of this research is to examine the students' views on grammar teaching conducted via the FCR model. The participants of the study are 44 students studying in the 7th grade of a secondary school affiliated to Elazığ Provincial Directorate of National Education in the 2021-2022 academic year. Of these students, 21 took part in the experimental group and 23 in the control group. The application process is limited to an eight-week experimental application process. In this process, the students of the experimental group were provided with grammar topics via EBA (Education Information Network). In the classroom, activities are carried out in which they can play an active role. On the other hand, the students of the control group were given grammar activities in the Turkish language textbooks and homework assignments in a classical style were given. At the end of the experimental process, a semi-structured interview guide prepared by the researcher was used to obtain the students' views on the grammar activities carried out via the FCR model. Interviews were conducted with 12 students in the experimental group, and then these data were analyzed for content via the MAXQDA qualitative data analysis software. As a result of the analysis, students stated that the FCR model creates a pleasant environment in the classroom, increases teacher-student and student-student interaction, and outside the classroom, gives them the advantage of being able to watch the subject at any time thanks to the course videos, being able to pause and re-watch the videos and helps them gain a sense of responsibility.

Keywords: Flipped classroom model, teaching of grammar, teaching of verbs

² This study has been reproduced from the doctoral thesis of İrem Toprak Kaya "The Effect of Flipped Classroom Model on Attitudes Towards Verb Learning and Grammar in 7th Grades" under the supervision of Prof. Dr. Şener Demirel at Fırat University, Turkey.



COMPARISON OF TIME MANAGEMENT OF LICENSED SWIMMERS AND NON-SPORTS ADOLESCENTS

Taner YILMAZ

Bekir TOKAY

Uşak University, Faculty of Sports Sciences, Physical Education and Sports ,Uşak, Türkiye
Orcid: 0000-0001-7443-6753

Uşak University, Faculty of Sports Sciences, Physical Education and Sports ,Uşak, Türkiye
Orcid:0000-0003-0059-0736

Abstract

This study aims to compare the Time Management Skills (TMS) of licensed swimmers and adolescents who are not interested in sports. The study sample consists of 252 (n=126 swimmers and n=126 non-athletes) adolescents aged between 14 and 18 (15.61±1.22). The Time Management Questionnaire (TMQ) was used to determine the time management skills of the adolescents who took part in this study. The data obtained from the participants were evaluated using the SPSS 25.0 statistics software. According to the statistical analysis, there is a statistically significant difference among adolescents in terms of their TMS based on the variables of "state of doing sports" and "place of residence" (p<0,05). On the other hand, there was no statistical difference between adolescents regarding their time management skills by gender and age variables (p>0,05). Based on the results, the state of doing sports in adolescents and the city they live in affect their time management skills, given that adolescents' time management skills could be improved by directing them to sports branches such as swimming.

Keywords: Swimming, Adolescent, Time Management

LİSANSLI YÜZÜCÜLER VE SPOR YAPMAYAN ADÖLESLANLARIN ZAMAN YÖNETİMİNİN KARŞILAŞTIRILMASI

Özet

Bu çalışmanın amacı lisanslı yüzücüler ile spor yapmayan adölesanların zaman yönetim becerilerinin karşılaştırılmasıdır. Çalışmanın örneklemi 14 ile 18 yaş aralığındaki (15,61±1,22) 252 (n=126 yüzücü ve n=126 spor yapmayan) adölesandan oluşmaktadır. Çalışmaya katılan adölesanların zaman yönetim becerilerinin belirlenmesinde Zaman Yönetim Ölçeği kullanılmıştır. Katılımcılardan elde edilen veriler ise SPSS 25.0 paket program kullanılarak değerlendirilmiştir. Yapılan istatistiki analizlerde spor yapma durumu ve yaşanılan şehir değişkenlerine göre zaman yönetimi becerisi açısından adölesanlar arasında istatistiksel olarak anlamlı bir farklılaşma tespit edilmiştir (p<0,05). Buna karşın cinsiyet ve yaş değişkenlerine göre zaman yönetimi becerisi açısından adölesanlar arasında istatistiksel olarak bir farklılaşma belirlenmemiştir (p>0,05). Elde edilen bulgulardan adölesanlarda spor yapma durumu ve yaşanılan şehrin zaman yönetim becerisini etkilediği sonucuna ulaşılmıştır. Buna göre adölesanların yüzme gibi sportif becerilere yönlendirilmesi suretiyle zaman yönetim becerilerini geliştirebilecekleri düşünülmektedir.



Anahtar Kelimeler: Yüzme, Adölesan, Zaman Yönetimi

1. INTRODUCTION

Time is a precious resource that flows at a certain rhythm. We can't turn back time, save, borrow or steal it all together. All we can do about this phenomenon, which we cannot change in any way, is to make the most of the moment we have (Güçlü, 2001). Since we cannot change the quantity of time we have, the only variable is the quality of time. No one else can use it on our behalf (Ulusoy, 1995). Its effective and efficient use is the only possibility to gain time (Stills, 2000).

The answers to questions such as how many of the events we experience happen the way we want them to, how many of these events do we determine to occur, and what are our effects in the processes of their occurrence, show our success in managing our time (Güçlü, 2001). However, the perception of time may differ among societies, individuals, or occasions. Time passes quickly in some cases and slowly in others (Vatan and Altuğ Özsoy, 2002). The competitive environment we live in nowadays encourages people to plan and manage time effectively from the very beginning of primary education. The high performance required by the conditions of competition forces institutions and managers to use time effectively and stipulates the pursuit of time management (Mohamed et al., 2018). Time management can be evaluated as a way of tracking time and taking control of it (Claessens, 2007), and also deliberately exercising control over the time available to perform tasks, refers to a method of planning and implementation to increase organizational efficiency, effectiveness and performance levels and reduce stress levels (Torres et al., 2019).

There is no consensus on the definition of time management in past studies (Brigitte, 2007). However, time management (Van Eerde, 2003), which is based on the assumption that documenting, managing, and combining time can help a person cope with his time efficiently (Van Eerde, 2003), is actually a self-management process and ensures control of the events we experience and it is individuals' directing the events by directing themselves. (Güçlü, 2001). In addition, it also plays a vital role in improving academic performance and success (Mohamed et al., 2018).

For the time being, the number of individuals who want to benefit from the opportunities offered by living in the city is increasing; In other words, it has increased the migration rates from the countryside to the cities and the population density in the cities. Many children and adolescents today engage in low levels of daily physical activity, and in many developed countries, only a small proportion of people follow daily physical activity recommendations (Tokay, 2022). As the working time of individuals increases, they barely get time for themselves. Physical and mental fatigue becomes a factor, and performance may decrease in overwork situations, even when they have worked efficiently for a certain period (Ulusoy, 1995).

However, this situation will reflect positively on the performances of athletes or sedentary individuals, if the processes of determining the pre-work needs by time management are implemented (Brigitte, 2007), and the goals to realize these needs, and prioritizing and planning the tasks required to reach these goals are determined. In doing so, planning processes consisting of different steps and periods that are considered necessary to achieve a goal will enable the individual to know beforehand the do's and don'ts. Thus, it will be easier to predict how any result will be reached (Macquet, 2010).

Physical inactivity can contribute to weight gain, apart from a decrease in energy expenditure. For example, recent research has shown significant associations between inactivity and consumption of less healthy foods and other negative health practices, such as increased fat intake, especially among adolescents and adults (Dinçay, 2010). Physical activity and exercises in adolescence undoubtedly have a crucial role in protecting the health of individuals. Considering this period as a period when



predictions about an athlete's future success are formed and the athlete is in his palmy days, it is the period when the attention should be paid mostly to nutrition, training, individual health, and care to keep performance at a high level (Bilici, 2019). It is considered very important to develop time management skills to use time effectively and efficiently in adolescence, which is the period when athletes and individuals make decisions that will shape the rest of their lives and carry out academic or sportive activities for this goal, so that the future is brighter for the individual. These studies aim to determine the level of time management of adolescent athletes and non-sports adolescents specific to swimming by using the time management questionnaire, and the effect of sports on time management.

Licensed swimmers in the 14-18 age group also continue their education. They go to the pool for training in the early morning or the evenings. According to the cities they live in, they need to allocate significant time for transportation. Therefore, licensed swimmers should attach importance to time management so that they can run together their sports and training lives. The comparisons with peers in the same age group who do not regularly do sports will contribute to the determination of differences and the literature.

2. METHODS

This study aims to compare the Time Management Skills (TMS) of licensed swimmers and adolescents who are not interested in sports. The study sample consists of 252 (n=126 swimmers and n=126 non-athletes) adolescents aged between 14 and 18 (15.61 ± 1.22).

2.1. Data Collection

For determining the Time Management Skills (TMS) of the adolescents participating in the study, the Time Management Questionnaire (TMQ) was used, which was translated into Turkish by Alay and Koçak (2002) and adapted into Turkish after its validity and reliability study. The questionnaire consists of 27 items and has three sub-dimensions (Time Planning (TP), Time Attitudes (TA), and Time Wasters (TW)). The questions asked in the items were designed in a 5-point Likert type. The positive items were scored as (Always (5), Never (1)), whereas negative items were scored as (Always (1), Never (5)) using the reverse scoring method. Since items 24, 25, 26, and 27 in the TW sub-dimension contain negative items, the reverse calculating method was used while entering the data. Participants' high scores on the Time Management Questionnaire (TMQ) indicate that they have good time management.

2.2. Statistical Analysis

The data obtained from the implementation of the questionnaire were evaluated using the SPSS 25.0 statistics software. The "Independent T-Test" was used in the pairwise comparison of within and between groups by the gender and place of residence variables; Regarding the age variable, the "One Way Analysis of Variance (ANOVA)" and "Tukey's Post Hoc" tests were used in the multiple comparisons between and within groups.

3. FINDINGS

The data obtained from the adolescents participating in the research were evaluated according to the variables of gender, age and city of residence.”



Table 1. Descriptive statistical data of all of the athletes participating in the study (n=252).

	Groups	Gender	n	Minimum	Maksimum	Grup X̄ ±SS	Toplam Ort±SS
Age (Year)	Swimmers	Male	64	14	18	15,69±1,17	15,61±1,22
		Female	62				
	Non-Sports	Male	65	14	18	15,52±1,26	
		Female	61				

Table 2. Comparison of Time Management Skills of Licensed Swimmers by City of Residence

Sub-Dimensions	City Scale	n	X̄	Ss±	S _{hata}	t Testi	
						t	p
TP	City and Province	162	46,02	±11,73	0,92	-8,503	0,000*
	Metropolitan	90	59,00	±11,37	1,19		
TA	City and Province	162	22,51	±4,30	0,33	-5,388	0,000*
	Metropolitan	90	25,53	±4,19	0,44		
TW	City and Province	162	14,47	±2,48	0,19	-1,961	0,051*
	Metropolitan	90	15,08	±2,11	0,22		
TMS	City and Province	162	83,01	±14,13	1,11	-8,756	0,000*
	Metropolitan	90	99,61	±14,93	1,57		

As a result of the data obtained from the adolescents participating in the study, it was determined that there was a significant difference in favor of the adolescents living in the metropolitan city according to the city variable (p>0.05).

Table 3. Comparison of Time Management Skills of Licensed Swimmers by Age

Sub-Dimensions	Age Groups	n	X̄	Ss±	F	p
TP	1 14	54	50,50	±10,75	1,577	0,181
	2 15	76	48,45	±11,19		
	3 16	57	53,47	±13,25		
	4 17	45	52,22	±16,67		
	5 18	20	47,95	±15,77		
	6 Total	252	50,66	±13,15		
TA	1 14	54	22,76	±2,88	1,282	0,277
	2 15	76	23,83	±1,12		
	3 16	57	24,53	±4,41		
	4 17	45	23,27	±5,81		
	5 18	20	23,00	±5,95		
	6 Total	252	23,59	±4,49		
TW	1 14	54	14,83	±2,11	0,650	0,627
	2 15	76	14,66	±2,67		
	3 16	57	14,89	±1,80		
	4 17	45	14,62	±2,43		
	5 18	20	13,95	±3,12		
	6 Total	252	14,69	±2,37		
TMS	1 14	54	88,09	±12,10	1,512	0,199
	2 15	76	86,93	±13,75		
	3 16	57	92,89	±16,76		
	4 17	45	90,11	±21,68		
	5 18	20	84,90	±20,48		
	6 Total	252	88,94	±16,45		

In our study, it was determined that there was no significant difference between and within groups in TMS according to the age variable (p<0.05).



Tablo 4. Comparison of Time Management Skills of Licensed Swimmers by Gender

Sub-Dimensions	Gender	n	X̄	±Ss	Shata	t Testi	
						t	p
TP	Male	64	56,52	±11,80	1,47	-0,836	0,405
	Female	62	58,21	±10,88	1,38		
TA	Male	64	25,75	±3,87	0,48	1,593	0,114
	Female	62	24,63	±4,02	0,51		
TW	Male	64	14,75	±1,91	0,24	-0,570	0,570
	Female	62	14,97	±2,35	0,29		
TMS	Male	64	97,02	±14,65	1,83	-0,303	0,762
	Female	62	97,81	±14,63	1,85		

When the in-group test values of the adolescent licensed swimmers participating in the study were examined according to the gender variable, no significant difference was found in the level of TMS and sub-dimensions ($p>0.05$).

Tablo 5. Comparison of Time Management Skills of Non-Sports Persons by Gender

Sub-Dimensions	Gender	n	X̄	±Ss	Shata	t Testi	
						t	p
TP	Male	65	42,94	±10,16	1,26	-1,054	0,294
	Female	61	45,07	±12,43	1,59		
TA	Male	65	21,95	±4,50	0,55	-0,079	0,937
	Female	61	22,02	±4,38	0,56		
TW	Male	65	14,66	±2,29	0,28	0,651	0,516
	Female	61	14,36	±2,87	0,36		
TMS	Male	65	79,55	±12,73	1,57	-0,775	0,440
	Female	61	81,44	±14,60	1,87		

No significant difference was found in terms of TMS and sub-dimensions in the comparison of in-group test values according to the gender variable of the adolescents who do not do sports ($p>0.05$).

Tablo 6. Comparison of Time Management Skills by Gender

Sub-Dimensions	Gender	n	X̄	Ss±	Shata	t Testi	
						t	p
TP	Male	129	49,67	±12,91	1,13	-1,218	0,224
	Female	123	51,69	±13,37	1,20		
TA	Male	129	23,84	±4,59	0,40	0,889	0,375
	Female	123	23,33	±4,39	0,39		
TW	Male	129	14,71	±2,10	0,18	0,129	0,897
	Female	123	14,67	±2,63	0,23		
TMS	Male	129	88,22	±16,23	1,42	-0,710	0,478
	Female	123	89,69	±16,72	1,50		

According to the data obtained from the research, it was found that there was no significant difference in terms of TMS and sub-dimensions of the adolescents participating in the study in terms of gender variable ($p>0.05$).

Tablo 7. Comparison of the Time Management Skills of the Groups

Sub-Dimensions	Groups	n	X̄	Ss±	Shata	t Testi	
						t	p
TP	Swimmers	126	57,35	±11,35	1,01	9,367	0,000*
	Non-Sports	126	43,97	±11,32	1,00		
TA	Swimmers	126	25,20	±3,97	0,35	6,065	0,000*
	Non-Sports	126	21,98	±4,42	0,39		
TW	Swimmers	126	14,86	±2,13	0,19	1,142	0,255
	Non-Sports	126	14,52	±2,58	0,23		
TMS	Swimmers	126	97,40	±14,59	1,30	9,515	0,000*
	Non-Sports	126	80,47	±13,64	1,21		

* $p<0,05$



When the TP, TA, TW and TMS of licensed swimmers and adolescents who participated in the study were compared, a significant difference was found in favor of the adolescents who do swimming sports ($p < 0.05$), but no significant difference was found between the groups in terms of TW ($p > 0.05$).

4. DISCUSSION AND CONCLUSION

It is believed that time management skills can be developed in advance for all kinds of positive and negative situations that may be encountered by planning the efforts of individuals in their lives and determining the goals as a result of this planning. Athletes' planning of pre- and post-training processes can be a phenomenon that may affect their performance. In this study, the data obtained from licensed swimmers and non-sports adolescents were compared by means of their effective use of time.

Within studies regarding time management in stressful situations, results were generally positive (Claessens et al., 2007). In previous relevant studies, Van Eerde (2003) reported that after the time management training, there was a significant decrease in the avoidance behavior and anxiety levels of the participants and an increase in their ability to manage time. Training regularly can positively affect their time management skills. (Zekioğlu et al., 2015).

Studies are reporting that time management skills increase when people follow healthy lifestyle tips (Erzincanlı et al., 2015). According to previous relevant studies based on the data we obtained in our study, Akıl and Yılmaz (2020), in their study with 1182 people between the ages of 14-17, reported that being physically active can affect time management skills and nutrition/exercise behaviors positively (Akıl and Yılmaz, 2020). In another study by Tekin (2020), which he conducted with 1535 participants between the ages of 18-22, he reported that while the level of physical activity increased, time management was positively affected, yet time wasters decreased. In addition, Zekioğlu et al., (2015) reported that the general time management skills of the athletes in the 14-18 age range were higher than the non-athletes, which is crucial in terms of the results showing parallelism with our study.

Contrary to the results of our study regarding the gender variable, as per the results of Alay & Koçak's study (2003) with 361 university students (165 females, 196 males), there is no significant difference between male and female students in terms of time attitudes, time reminders, and academic achievement; But there was a significant difference in favor of female students in the time planning variable. Similarly, Trueman & Hartley (1996), in their study with university students, reported that female students' time management skills were significantly better than male students. Sugötüren et al., (2011) concluded that female university students have better time management skills. These results show no similarities to the results we obtained in our study.

As a result, when the time management skills of the groups were compared by statistical analysis, significant differences were found in favor of the athlete adolescents in terms of TP, TA, and TMS ($p < 0.05$), but no difference was found in terms of TW ($p > 0.05$). A statistically significant difference was found among adolescents in terms of time management skills by the variables of "status of doing sports" and "place of residence" ($p < 0.05$). On the other hand, there was no statistical difference between adolescents regarding time management skills by gender and age variables ($p > 0.05$). Based on the results, the state of doing sports in adolescents and the city they live in affect their time management skills. Considering that, adolescents can improve their time management skills by going for sports branches such as swimming.



5. KAYNAKÇA

- Akıl, M., & Yılmaz, N. (2020). Adölesanlarda Fiziksel Aktivite Seviyesi İle Beslenme-Egzersiz Davranışı ve Zaman Yönetimi Arasındaki İlişki. *The Journal Of Academic Social Sciences*.
- Alay, S., & Koçak, S. (2002). Validity and Reliability of Time Management Questionnaire; Hacettepe Üniversitesi Eğitim Fakültesi Dergisi, Vol:22, pp. 9-13
- Alay, S., & Koçak, S. (2003). Üniversite Öğrencilerinin Zaman Yönetimleri ile Akademik Başarıları Arasındaki İlişki; Kuram ve Uygulamada Eğitim Yönetimi, Vol: 35, pp. 326-335.
- Bilici M.F. (2019). Beslenme ve Obezite, Güven Plus Grup A.Ş. Yayınları, 1. Baskı, Editör: Çetin Yaman, Ekim.
- Brigitte, J.C., Claessens Eerde, W.V., Rutte, C.G., & Roe, R.A. (2007). A review of the time management literature. Emerald Group Publishing Limited, 2005, 36(2).
- Claessens, B.J., Van Eerde, W., Rutte, CG., & Roe, R.A. (2007). A review of the time management literature. *Personnel review*.
- Dinçay, H. (2010). The Relationship Between Physical Activity Levels And Time Management Skills Among Selected University Students, A Thesis Submitted To The Graduate School Of Social Sciences Of Middle East Technical University, June.
- Erzincanlı, S., Zaybak, A., & Khorshid, L. (2015). Hemşirelik Öğrencilerinin Sağlıklı Yaşam Biçimi Davranışları ve Zaman Yönetimi Becerileri. *Ege Üniversitesi Hemşirelik Fakültesi Dergisi*, 2015, 31(2):8-25.
- Güçlü, D.D.N. (2001). Zaman Yönetimi. Kuram ve Uygulamada Eğitim Yönetimi, 25 (25) , 87-106.
- Macquet, A.C. (2010). Time management in the context of elite sport training. *Sport Psychologist, Human Kinetics*, 24(2): 194-210.
- Mohamed, O., Hamal, R.B., & Mohamed, K. (2018). A study on time management: case of Northeast Normal University international students. *European Journal of Alternative Education Studies*.
- Sugötüren, M., Ballı, M.Ö., & Gökçe, H. (2011). Spor Bilimleri ve Teknolojisi Yüksekokulunda Öğrenim Gören Öğrencilerin Zaman Yönetimi Davranışları. *Spormetre*, 2011, 3: 91-96.
- Tekin, H.K. (2020). Sosyal Problem Çözme Becerisi ve Zaman Yönetiminin Fiziksel Aktivite Seviyesine Etkisi, Uşak Üniversitesi Lisansüstü Eğitim Enstitüsü Beden Eğitimi ve Spor Öğretimi, Yüksek Lisans Tezi, Uşak.
- Tokay, B. (2022). Tüm Spor Bilimleri Programları İçin Beden Eğitimi ve Sporun Temellerine Güncel Bakış: Beden Eğitimi ve Sporda Meslek Alanlarının Geleceği, Editör: Gamze Beyazoğlu, Gazi Kitabevi, 1. Baskı, Eylül, Ankara.
- Torres, M., Duarte M., & Conceição O. (2019). The Influence of Time Management Behaviours on Performance and Stress. In Proceedings of the European Conference on Management, Leadership & Governance, November, (pp. 374-382).
- Trueman, M., & Hartley, J. (1996). A comparison between the time-management skills and academic performance of mature and traditional- entry university students; *Higher Education*, Vol: 32, pp. 199-215.
- Ulusoy, T. (1995). Zaman Yönetimi ve Yönetici Açısından Zaman Yönetiminin Araştırılması. Doktora Tezi. İstanbul Üniversitesi, Sosyal Bilimler Enstitüsü, İşletme Fakültesi.



INTERNATIONAL ASIAN CONGRESS ON CONTEMPORARY SCIENCES – VII

Van Eerde, W. (2003). Procrastination at Work and Time Management Training, *The Journal of Psychology*, 137:5, 421-434.

Vatan, F. & Altuğ Özsoy S. (2002). Zaman Yönetimi. *Ege Üniversitesi Hemşirelik Yüksek Okulu Dergisi*, 18 (1-3):89-104.

Zekioğlu, A., Erdoğan, N., & Türkmen, M. (2015). The Relationship Between Time Management Skills and Academic Achievement of The Student Athletes, *International Journal Of Psychiatry and Psychological Researches*, Issue 04 Autumn Winter Semester.



VIRTUAL UNIVERSE IN THE SUPPLY CHAIN (METAVERSE)

Ilker Ibrahim Avşar

Asst. Prof. Dr., Osmaniye Korkut Ata University, Bahce Vocational School

ORCID: 0000-0003-2991-380X

Dilara Berrak Tarhan

Dr., Orcid ID : 0000-0002-4303-5292

Abstract

Industrial revolutions have deeply affected business life. Every innovation in the field of technology causes changes in the way of doing business. In the fourth industrial revolution, some technologies stand out with their potential for change. Examples of these technologies are virtual reality, augmented reality, big data, blockchain, artificial intelligence. These technologies have the potential to leave a deep impact in many areas with the power of Web 3.0 architecture. One of the technologies that emerged with the use of the mentioned technologies together is the virtual universe technologies. Virtual universe technologies; It is trying to transform the Internet beyond being a click-to-use platform and transform it into a platform for taking part in the Internet. Companies may also want to take part in this new universe. Companies operating in the supply chain sector can use the virtual universe for different purposes, especially personnel training. With work; A literature review of technologies for the virtual universe was made. It has been considered that non-technical vision-oriented work is important in terms of showing the potential of the virtual universe technology, which is still in the development stage.

Keywords: Supply Chain, Metaverse, Virtual universe

1. Introduction

The last waves of the industrial revolution brought numerical transformation in business life. In the last wave, machines were connected to each other numerically and advanced software solutions began to be offered. The final wave components are mostly physical in nature, and we use communication technologies to understand the physical. In other words, we use numerical technologies to understand physical technologies. The virtual universe is a digital world. Digitizing the physical world of the supply chain is the goal of digital operations. It is desired to create a new world with the virtual universe that is permanent and can stand on its own. This does not prevent it from opening doors to the physical world. Metaverse stands for faster and collaborative product design. In addition, the transparent supply chain will pave the way for a product that can be traced to the door for the customer (Calhoun, 2021).

The first transformation phase of the supply chain is focused on the Internet of Things (IoT). In the first phase, machines and systems were connected to each other. The virtual universe is a digital world from scratch. The Virtual Universe aims to create a virtual space that can be transformed into the physical world. It aims for a platform that interfaces with reality, stands on its own and is permanent (Kathiala, 2022).

Serious changes are expected in supply chain operations after the virtual universe (Trebilcock, 2022). The virtual universe enables activities such as shopping and meetings in a holographic environment.



The Virtual Universe, which is expected to have a profound impact on the way of doing business, will primarily find its place in areas dominated by e-commerce (Frachtbox, 2022).

2. Materials and Methods

In the study, publications obtained from the scanned databases were used as primary sources. Internet sources were also utilized due to the scarcity of publications on the virtual universe and logistics/supply chain.

3. Virtual Universe in Supply Chain

Will the virtual universe redefine the supply chain? We can consider this issue from different angles. The first is manufacturing; the Virtual Universe will enable us to simulate products, production processes and production locations. Secondly, the short product life cycle will facilitate stakeholder collaboration in product design, sharing the design with producers and receiving feedback on the product. The third is efficient procurement; transparent procurement with unlimited collaboration across the value chain. The fourth is warehouse operations; in a 3D world, warehouses will be designed and utilized more efficiently. Fifth, transparency; the Metaverse will be informative on many issues such as how products are produced, stored and distributed through the 3D world (Kathiala, 2022).

3.1. Sample Application

Metadatabase (MDB), Virtual Reality (VR), Artificial Intelligence (AI), mobile application and Internet of Things (IoT) technologies are used in an integrated cloud platform to unify the physical and virtual logistics world. These technologies are combined to enable the user to utilize the entire supply chain end-to-end. These technologies are essential for flexible, reliable and scalable logistics. The application consists of 5 separate components: digital twin, mobile app builder, IoT, adaptive embedding and digital labeling. With a digital twin, companies can create 3D twins to optimize the layout of their facilities. The no-code mobile app builder allows businesses to quickly move to a portable platform. All devices can be connected to each other with the IoT section. In this way, valuable information such as product location can be obtained. With digital labeling management, supply chain members always have access to the correct label template (Mayer, 2022).

3.2. Basic Components of the Virtual Universe

3.2.1. Augmented reality

Augmented Reality (AR) is a type of 3D technology (Yun, 2019: 5). 3D simulation is a different technology than 3D animation or video. AR objects can be seen as in the real world and can be used in areas such as education (Afandi et al., 2019: 5).

Today, there is talk of an AR world that will be displayed in wearable AR glasses or lenses and will exist continuously. The combined use of AR, AI and IoT technologies will ensure smartness in systems (Nijholt, 2021: 573).

3.2.2. Virtual reality

The use of VR in education paves the way for easier and more permanent learning. It is the path to learning by doing and experiencing. Since it has the ability to entertain while teaching, it can make the act of learning not a boring process. In addition to reducing costs, it paves the way for experiences that users cannot obtain in the physical environment they live in (Kaleci et al., 2017: 684).

VR will be used more and more in the field of health (Demirci, 2018: 43). Examples of health use include simulation, 3D imaging and education. It is assumed that with the use of virtual reality in the field of health, the level of knowledge of the personnel will increase, studies to increase patient motivation can be carried out, and treatment costs can be reduced (Öztürk & Sondaş, 2020: 167).



VR can be used for staff training and performance evaluation in supply chain applications. A comprehensive virtual environment will be useful for training employees in warehouse or supply chain dynamics. This operation should not only be considered as a learn-to-do operation, it should also be evaluated as eliminating the risk of trial and error in real-time decision-making in high-risk situations. The different benefit is that the trainer does not have to share the same physical environment with the people he/she will teach the subject (Sidharth, 2021). With the elimination of this obligation, business travel is likely to disappear (Liddell, 2021).

3.2.3. Artificial intelligence

Artificial intelligence has an important place in the efforts of businesses to increase efficiency in business processes (Ever & Demircioğlu, 2022: 67). In this context, the logistics sector has to turn to new technologies in order to have competitive features. One of these technologies is artificial intelligence, which has the power to revolutionize transportation-related issues. Increasing customer demands and large amounts of data create space for artificial intelligence in the sector (Aylak et al., 2021: 89).

3.2.4. Web 3.0 and higher technologies

Artificial intelligence-supported technologies pave the way for Web 3.0/Web 4.0 applications. Virtual reality applications, in which sensors and intelligent agents are involved, are rapidly moving towards establishing a connection between real life and virtual life (Ersöz, 2020: 63). In order to follow this progress, they need to keep up with the changes that are accelerating with Web 3.0 (Kapan and Üncel, 2020: 286).

3.2.5. Meta database

MDB aims for an immersive user experience using technologies such as AR, IoT and 5G. This technology is the gateway to many different interaction channels, such as a virtual trade fair. Logistics is one of the areas that is expected to benefit the most from metadata technology. In logistics, it is expected to optimize work steps, control cost overruns, and facilitate connectivity between stakeholders (Interlake, 2022). MDB represents the future of some sectors, especially e-commerce (Hudson, 2021).

Supply chain MDB can provide intuitive knowledge and gain context from their experience. It can also be used to prevent the occurrence of blockages, delays and other problems. Due to such features, although the use of the Virtual universe in the supply chain contains great promises, there are challenges that need to be overcome. Difficulty in accessing supply chain data from a center, difficulty of quality control and inspection in international companies, disruption of the flow of goods in the international supply chain can be listed as possible problems (Jürgens, 2021)

4. Conclusion

With the developing technology, new models such as artificial intelligence, blockchain, cyber-physical systems, the Internet of Things, and cloud computing are increasingly on the world agenda (Yacan, 2021: 37). Web 3.0 and the subsequent use of technologies such as virtual reality, augmented reality and artificial intelligence pave the way for virtual universe applications. The virtual universe platforms to be created offer opportunities for businesses. Businesses that will take part in virtual universe platforms will be able to carry out their business with a visionary approach.

In the non-technical vision-oriented study; the use of the virtual universe in the supply chain process is discussed. Virtual universe technologies have the potential to be used in different areas such as personnel training, product tracking in the supply chain, and product status monitoring.

Metaverse, one of the virtual universe platforms, is making efforts to solve the language problem (Malyukov, 2022). When virtual universe platforms gain instant translation capabilities at the



commercial level, they can be preferred for corporate communication in international operations such as supply chains.

References

- Afandi B., Kustiawan I and Herman N.D., (2019). Exploration of the augmented reality model in learning, *J. Phys.: Conf. Ser.* 1375 012082
- Aylak, B. L., Oral, O. & Yazıcı, K. (2021). Yapay Zekâ ve Makine Öğrenmesi Tekniklerinin Lojistik Sektöründe Kullanımı. *El-Cezeri*, 8 (1), 74-93. DOI: 10.31202/ecjse.776314
- Calhoun Steven, (2021). The Metaverse and Manufacturing: Hype vs Reality, <https://www.veryableops.com/blog/metaverse-manufacturing-hype-vs-reality>, (Erişim: 15.05.2022)
- Demirci, Ş. (2018). Sağlık Hizmetlerinde Sanal Gerçeklik Teknolojileri. *İnönü Üniversitesi Sağlık Hizmetleri Meslek Yüksek Okulu Dergisi*, 6(1), 35-46, <https://dergipark.org.tr/tr/pub/inonusaglik/issue/37019/390595>
- Ersöz, B. (2020). Yeni Nesil Web Paradigması-Web 4.0. *Bilgisayar Bilimleri ve Teknolojileri Dergisi*, 1 (2), 58-65
- Ever, D. & Demircioğlu, E. N. (2022). Yapay Zekâ Teknolojilerinin Kalite Maliyetleri Üzerine Etkisi. *Çukurova Üniversitesi Sosyal Bilimler Enstitüsü Dergisi*, 31 (1), 59-72. DOI: 10.35379/cusosbil.1023004
- Frachtbox team, (2022). Metaverse and logistics, <https://www.frachtbox.com/blog/metaverse-and-logistics>, (Erişim: 15.05.2022)
- Hudson Nia (2021). What will e-commerce look like in the metaverse?, <https://www.ti-insight.com/briefs/what-will-e-commerce-look-like-in-the-metaverse>, (Erişim: 15.05.2022)
- Interlake, (2022). The metaverse: how would it affect industry and logistics?, <https://www.interlakemecalux.com/blog/metaverse>, (Erişim: 15.05.2022)
- Jürgens Jan, (2021). The Metaverse of the Supply Chain, <https://topo.cc/the-metaverse-of-the-supply-chain>, (Erişim: 15.05.2022)
- Kaleci, D., Tepe, T. & Tüzün, H. (2017). Üç Boyutlu Sanal Gerçeklik Ortamlarındaki Deneyimlere İlişkin Kullanıcı Görüşleri. *Türkiye Sosyal Araştırmalar Dergisi*, 21 (3), 669-689. <https://dergipark.org.tr/tr/pub/tsadergisi/issue/33038/325906>
- Kapan, K. & Üncel, R. (2020). Gelişen Web Teknolojilerinin (Web 1.0- Web 2.0- Web 3.0) Türkiye Turizmine Etkisi. *Safran Kültür ve Turizm Araştırmaları Dergisi*, 3 (3) , 276-289
- Kathiala Roit (2022). Is the Metaverse the next big thing in supply chain?, <https://www.logisticsmgmt.com/article/is-the-metaverse-the-next-big-thing-in-supply-chain>, (Erişim: 15.05.2022)
- Liddell Devin (2021). How the metaverse will change transportation as we know it. <https://www.fastcompany.com/90694275/how-the-metaverse-will-change-transportation-as-we-know-it>, (Erişim: 15.05.2022)



- Malyukov P. (2022). Metaverse, Languages in the metaverse: Why AI is critical for communication in the brave new world, <https://venturebeat.com/datadecisionmakers/languages-in-the-metaverse-why-ai-is-critical-for-communication-in-the-brave-new-world/>, (Eriřim: 12.11.2022)
- Mayer Marina (2022). Logistics Platform Uses Power of Metaverse to Bridge Physical, Digital Gap, <https://www.sdexec.com/software-technology/ai-ar/news/22144466>, (Eriřim: 15.05.2022)
- Nijholt Anton (2021). Experiencing Social Augmented Reality in Public Spaces, *UbiComp '21: Adjunct Proceedings of the 2021 ACM International Joint Conference on Pervasive and Ubiquitous Computing and Proceedings of the 2021 ACM International Symposium on Wearable Computers*, Pages 570–574 <https://doi.org/10.1145/3460418.3480157>
- Öztürk, E. O. & Sondař, A. (2020). Sanal Saęlık: Saęlıkta Sanal Gerçeklięe Genel Bakıř. *Kocaeli Üniversitesi Fen Bilimleri Dergisi*, 3(2), 164-169. <https://dergipark.org.tr/tr/pub/koufbd/issue/57843/774210>
- Sidharth Rachayita (2021). Bringing the ‘Meta’ change in supply chain through VR, <https://www.logisticsinsider.in/bringing-the-meta-change-in-supply-chain-through-vr>, (Eriřim: 15.05.2022)
- Trebilcock Bob, (2022). Are we ready for the Metaverse?, <https://www.logisticsmgmt.com/article/are-we-ready-for-the-metaverse>, (Eriřim: 15.05.2022)
- Yacan, İ. (2021). Endüstri 4.0 Teknolojileri ve Toplum 5.0 Kavramı. *Yeni Fikir Dergisi*, 13(27), 31-39
- Yun Mei, Qimeng Nie, Fang Wang *et al* (2019), Application of Augmented Reality Technology in Industrial Design, *IOP Conference Series: Materials Science and Engineering, Volume 573*, 2019 7th International Forum on Industrial Design 17–19 May 2019, Luoyang, China *IOP Conf. Ser.: Mater. Sci. Eng.* 573 012062



SIYASAL İLETİŞİM SÜRECİNDE HAKİKAT ÜRETİMİ: DON'T LOOK UP ÖRNEĞİ

Süleyman ŞAHAN

Gaziantep Üniversitesi İletişim Fakültesi, Reklamcılık Bölümü, Gaziantep, Türkiye

Özet

Siyaset ile hakikat arasındaki çok boyutlu ve karmaşık bir ilişki bulunmaktadır. Bu ilişki tarihin hiçbir döneminde günümüzde kadar karmaşık bir yapı göstermemiştir. Bunun en büyük nedenlerinin başında bilimsel alanın aktörü olan politik profesyoneller ve uzmanların güç ve iktidarın korunup sürdürülmesinde siyasetçilere yardımcı bir güç haline gelmeleridir. Bir diğer etken ise yine politik profesyoneller ve uzmanlarla bağlantılı olarak siyasetin medyatikleşerek gösterisel şova dönüşmesidir. Böylece hakikat ve hakikat olmayan arasındaki sınır bulanıklaşmış, ikisi arasındaki farkı ayırt edebilmek zorlaşmıştır.

Çalışmada siyasal iletişim sürecinde hakikatin yeniden üretimi “Don’ Look Up” filmi örneğinde incelenmektedir. 2021 yılında Netflix platformunda yayınlanan filmde hakikatin yeniden üretildiğini gösterebilmek için nitel içerik analizi yöntemi kullanılmıştır. Nitel içerik analizi yöntemi kullanılarak hakikatin nasıl inşa edildiği ortaya konulmaya çalışırken Andreas Dörner’in Politainment kavramından yararlanılmıştır. Nitel içerik analizi için kategoriler oluşturulurken Dörner’in Politainment kavramı yol gösterici olmuştur. Araştırma sonucunda hakikatin eğlence boyutunda sadeleştirilmiş ve parçalanmış yeni bir biçimde, kişiselliği merkeze alarak sunulduğu tespit edilmiştir. Ayrıca medya ve siyasal aktörler arasındaki karşılıklı bağlar, duygusal yönün her zaman için ön plana çıkarılması, eğlence kamusu yaratılarak eğlencenin belirginleşmesi yeni hakikatin özellikleri arasındadır.

Anahtar Kelimeler: Hakikat, Siyasal İletişim, Neoliberalizm

GENERATION OF TRUTH IN THE PROCESS OF POLITICAL COMMUNICATION: THE EXAMPLE OF DON'T LOOK UP

Abstract

There is a multidimensional and complex relationship between politics and truth. Never in history has this relationship been as complex as it is today. Never in history has this relationship been as complex as it is today. One of the biggest reasons for this is that political professionals and experts, who are actors in the scientific field, have become a helping force for politicians in preserving and maintaining power. Another factor is the transformation of politics into a spectacle by becoming mediatized in connection with political professionals and experts. Thus, the border between truth and non-truth has blurred, making it difficult to distinguish the difference between the two.

In the study, the reproduction of truth in the process of political communication is examined in the example of the movie "Don't' Look Up". Qualitative content analysis method was used to show how the truth is reproduced in the movie released on the Netflix platform in 2021. While trying to reveal how the truth is constructed using the qualitative content analysis method, Andreas Dörner's concept of Politainment was used. While creating categories for qualitative content analysis, Dörner's concept



INTERNATIONAL ASIAN CONGRESS ON CONTEMPORARY SCIENCES – VII

of Politainment has been a guide. As a result of the research, it has been determined that the truth is presented in a new way, simplified and fragmented in the dimension of entertainment, by centered on the personality. In addition, the mutual bonds between the media and political actors, emphasizing the emotional aspect at all times, making entertainment clear by creating an entertainment public are among the features of the new truth.

Keywords: Truth, Political Communication, Neoliberalism



THE ROLE OF LANGUAGE TEACHERS IN INTERCULTURAL LANGUAGE TEACHING

Tuğba Otman

Ondokuz Mayıs University Faculty of Education Department of Foreign Languages Education,
Samsun, Turkey

Abstract

In English language teaching field, receptive and productive skills have been the terms used to describe the teaching-learning process. They refer to four skills: reading, listening, speaking writing and they are necessary to conduct a successful communication. Reading and listening skills require the speaker to receive input, whereas speaking and writing skills require the speaker to produce output. In other words, reading and listening skills are receptive skills, speaking and writing skills are productive skills. Although all of the four skills are essential components of the language-learning process, they are not enough to specify the teaching process. Communicative competence, which refers the ability of the learner to communicate in the target language, is no longer the only and main aim of English language teaching. Instead of ‘communicative competence’, ‘intercultural communicative competence’ (ICC) is the term that describes the objective of language teaching. Culture has been started to be placed among the above mentioned four skills. It is undeniable that this significant change in language teaching is a crucial need in today’s world. Despite the indispensable relationship between culture and language, culture has been neglected in the process of language teaching for a long time. Yet due to the spread of English and the increased number of English speakers, it has become a necessity to place culture in English language teaching context. Regarding the context of English language teaching, culture is integrated into the teaching process either to teach the language or to teach the content of different cultures. However, the important aspect is how it is integrated in the teaching context. In the light of research focusing on this issue, this paper discusses the importance of intercultural communication and its adaptations in ELT classes from the perspective of language teachers.

Keywords: teaching culture, intercultural communication competence, language teaching

INTRODUCTION

In the present day, globalization makes mobility accessible for more people day by day. In other words, it is more likely to observe culturally diverse societies. “Each individual belongs to a special group. Every person characterized by different ways of thinking, behaviors, rituals, clothes, beliefs, values, and norms. He/she can be easily differentiated from the other group of people (Mahadi, & Jafari, 2012). These peculiar characteristics of the groups constitute ‘culture’. Being a good communicator in these societies is only possible when people show tolerance, respect and understanding towards others.

Regarding the strong association between globalization and the English language, it is possible to state that globalization resulted as the spread of English. The global function of English makes it the most taught language in the world. Therefore, new varieties of the language emerged. In other words, it is possible to see the effect of culture on different forms of English and an English speaker is expected to communicate in English with diverse speakers from different cultural backgrounds.

BACKGROUND OF THE STUDY



Thanks to the developing technology and opportunities, it is possible to observe cultural diversity in different units of society today and in this cultural diverse world, having intercultural competence is of great importance. Due to the latest advancements in communication technologies and increased mobility intercultural communicative competency is now a crucial topic to include in first- and second-language instruction (Liddicoat & Scenario, 2013). Similar to the globalized world itself, today's schools are also becoming linguistically and culturally diverse places. In other words, it has gained an importance to become intercultural competent speakers than ever before. Living in culturally diverse societies expect the individuals not only to be competent English speakers but also tolerant and respectful towards other cultures. As Girik Allo (2018) mentions as a result of the intercultural encounters people begin to be aware of the diversity among others and learn to understand the difference including of receiving it. In order to have intercultural competent communicators in the society, the notion of interculturalism should be tackled in foreign language education in particular.

Taking the strong bond between language and culture into account, it is possible to state that the language teachers have an increasing responsibility to place culture in their classrooms. The intercultural dimension of language teaching requires the educators to be competent as well. Teachers should adapt relevant teaching techniques to prepare the students for effective cross-cultural communication contexts since the linguistic proficiency of students will not help them to carry out successful communication in the current world. Language teachers are required to realize the influence of cultural assumptions on the act of communication.

It is advised to English teachers to change their traditional teaching models and adapt more interactive methods which promote sensitivity, tolerance towards other cultures (Zhang, X., & Zhang, J. 2015). Baroudi (2017) investigated the Intercultural Communicative Competence in ELT classrooms at Eastern Mediterranean University and the data collected from 127 ELT students show that 98.5 percent of the students consider intercultural communicative competence as an important part in language learning and teaching. Same study results reveal the importance of 4 components (knowledge, skill, awareness, and attitude) of intercultural communication. The numbers show that "attitude" dimension has more importance than other dimensions among the participant students. Girik Allo (2018) investigated the place of culture and intercultural communication and perceptions of Torajan students on intercultural communication. The study was performed on 207 students of English Study Program. The results show that 70 percent of the students agree that higher educational institutions should offer intercultural communication courses to students.

Girik Allo (2018) notes that 80 percent of the students believe that L2 culture teaching improve intercultural competence. "Successful intercultural EFL classrooms are determined by consciously address the growing need for healthy and democratic interaction among students" (Girik Allo, 2018, p.169). It is the responsibility of language teachers to develop cross-cultural competence and an understanding of how diverse cultural perspectives influence how the students act and what they learn. In order to contribute to the best learning outcomes for the students, teachers should have awareness, develop appreciation and sensitivity other cultures. For this reason, it is a need to study on the role of language teachers in intercultural language teaching. A review of literature shows that there is not much research about the specific topic 'intercultural competence' in Turkey, regarding the perspective of Turkish teachers of English language and in today's world it is a need to tackle this area regarding ELT context. This study aims to investigate the attitudes of Turkish teachers of English on intercultural competence teaching and to see how and to what extent these attitudes are implemented to their classrooms, as reported by the participant teachers.



MATERIALS AND METHODS

The data of the present study, which is a descriptive study in nature, is collected through an online survey. The researcher conducted the online survey in the academic year of 2020-2021. The survey was adopted by Atay et al (2009) and edited according to the purpose of the study. The questionnaire consists of seven sections including open ended questions and Likert scale questions. Participants of this study were 40 Turkish teachers of English from all regions of Turkey. The teachers were selected randomly from private and public schools working in primary and secondary schools. The survey shows that 40% of the participant teachers are working in private schools. Teaching experience of the participants is as follows: 1-5 years of teaching experience make 60%, 6-10 years of teaching experience make 32, 5% and 16-20 years of teaching experience make 7, 5% of the participants.

RESULTS

The researcher analyzed the collected data by taking the frequency counts for each question. The analysis is presented through range charts. As stated above, the online questionnaire of this study includes seven parts. The first part asks the participant’s schools and years of teaching experience. The second section asks the participants to prioritize their opinions about different objectives of foreign language teaching through Likert scale questions which consists of 5 statements on a 5 point scale ranging from “very important” to “not important at all.” According to the results, 31 teachers out of 40 state the main priority of teaching English “improving the awareness of students at a global context”. For the second most priority, the data shows that 13 teachers out of the all participants respond as ‘helping students understand their own cultures and identities better’. The analysis of responses for each statement is presented in Figure 1. The figure below represents the data which states that none of the participant teachers disregards the importance of intercultural awareness of language learners.

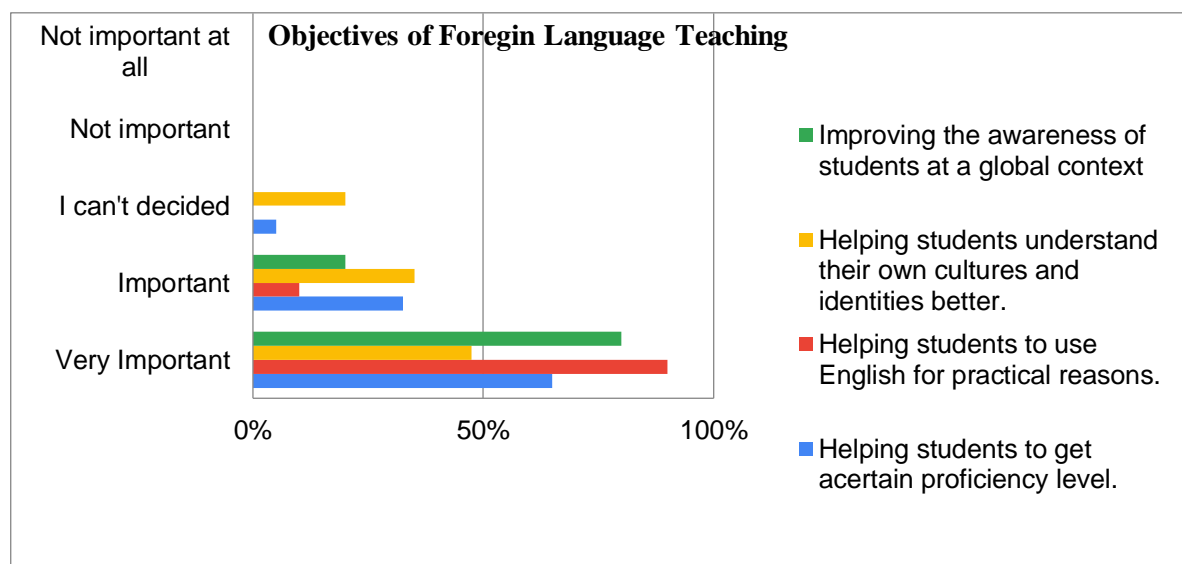
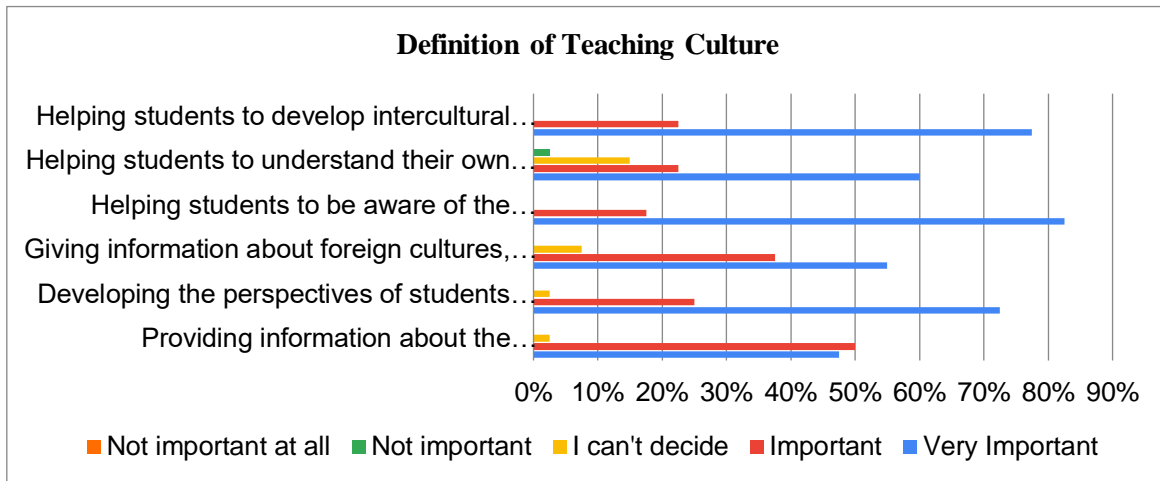

Figure 1. The objectives of foreign language teaching from teachers’ perspectives



The third part of the study asks the participant teachers to indicate the definition of teaching culture by making a choice from the given 6 statements. These 6 statements refer 3 different dimensions of culture, “the knowledge dimension,” “the attitudinal dimension,” and the “skills dimension” (Castro, Sercu, & Garcia, 2004, p. 98 as cited in Atay et al., 2009, p.128). The same Likert scale range of the previous question is used in this section and the results show that 82% of the participants (33 participant teachers) give importance to the students ‘acquisition of behavior in intercultural situations. As shown in Figure 2 below the majority of the participants Turkish teachers of English consider that acquisition of students’ own culture has least importance among the objectives of culture teaching.



Figure

2. Definition of teaching culture

In English classes teachers are role models for the students to become an intercultural competent communicator. Thus, the awareness of the teacher has also a great role in the teaching process. The fourth section of this study aims to investigate the relationship of teachers with other cultures in terms of daily lives, history, music and rituals. The participants are expected to indicate how frequently they get connect with the foreign culture. The adverbs of frequency used in this section are ‘never’, ‘sometimes’ and ‘often’. The result shows that more than half of the teachers (60%) contact with the target language culture through mass media and it is clear from the results that teachers do not travel very often to abroad.

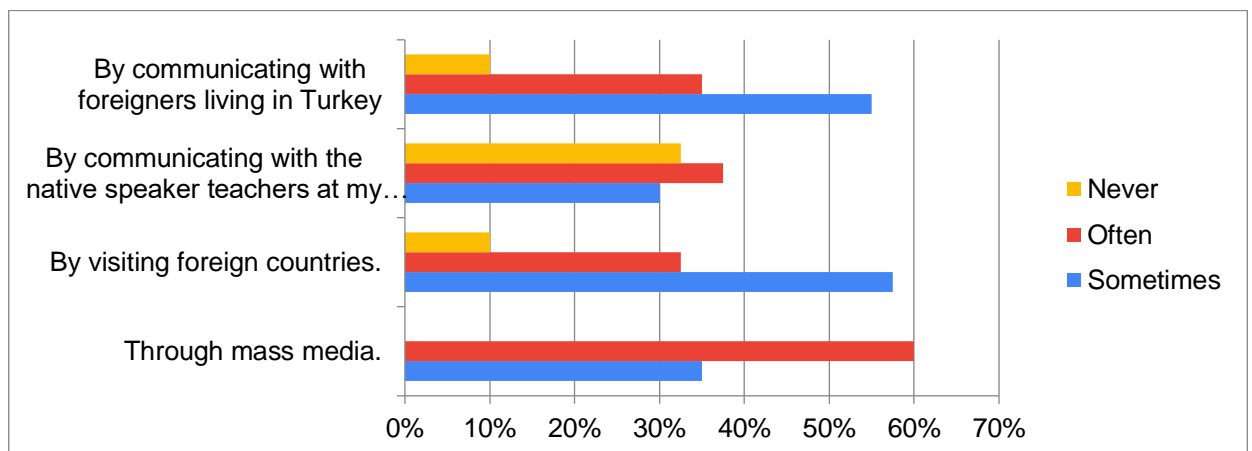
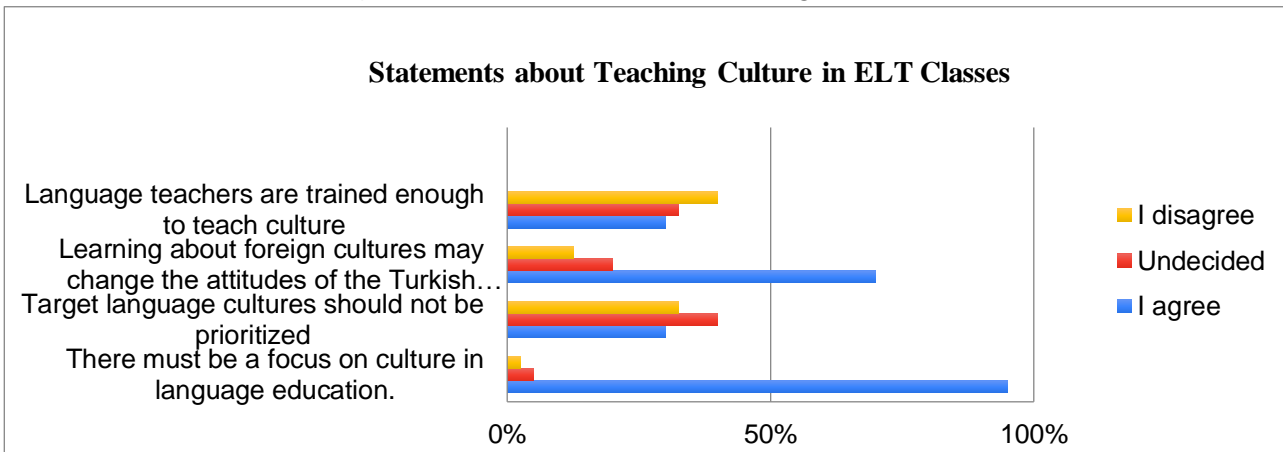

Figure 3. Ways of communication with foreign people and cultures



In the fifth section, the participants are given 4 statements about the role of culture in foreign language education and the competency of English language teacher in that area. Teachers indicate their opinions on a 3-point Likert scale ranging from “I agree” to “I disagree”. The given statements are as follows: “There must be a focus on culture in language education”; “Target language cultures should not be prioritized”, “Learning about foreign cultures may change the attitudes of the Turkish student towards his own culture “and “ Language teachers are trained enough to teach culture.” The highest number of teachers indicates their agreement on the focus of culture in language education. As the range column chart reveals below, 40 % of the participants think that language teachers are not trained enough to teach culture. 70% percent of the teachers believe that learning about foreign cultures can help the students to acquire positive attitudes towards their own culture and additionally, 40% of the participant teachers agree on the statement that target language culture should not be prioritized in the classes. In other words, instead of mono cultural techniques; multicultural techniques and approaches should be adopted by the teachers.

Figure 4. Teachers’ ideas about teaching culture in ELT classes



The sixth section of this study focuses on the classroom implementation of cultural components to classrooms. In this part, teachers are given 6 examples of classroom implementations and they are asked to state how frequent they apply the given practices in their classrooms on a Likert Scale among ‘never’, ‘sometimes’ and ‘often’. According to the collected data, as presented below, with 60%, the most frequent used classroom implementation is using audio-visual materials and the least frequent adapted way is to invite people with having lived abroad to the classroom.

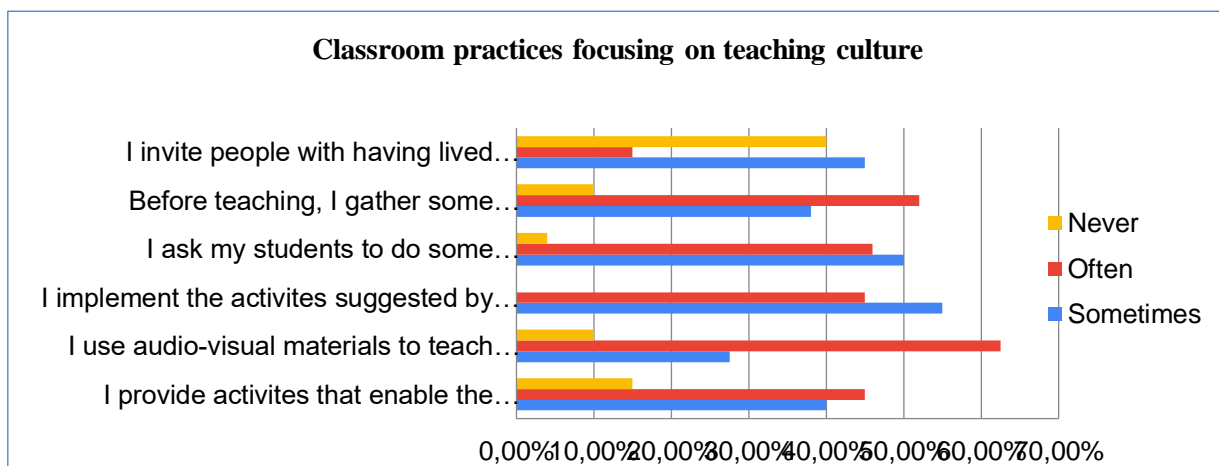

Figure 5. Classroom practices of teachers on teaching culture

The last section of the study consists of 2 open ended questions. One of the questions expects the teachers to indicate their suggestions to guide English teachers to become more competent in culture teaching and ways to guide them in this process. The answers are categorized in two subcategories. One of them supports to train teachers with seminars, in service training sessions and adapting courses in ELT departments of



universities, so that prospective teachers will be graduated in a more competent way in terms of teaching culture. The other suggested ways for teacher guidance is directly related with the interaction of other cultures. Most of the participants of this study answered this question by supporting the idea of encouraging teachers to participate and provide more international projects.

In order to become more competent and raise awareness of the students, language teachers should also have the opportunity to engage with foreign cultures. One of the ways to reach this goal is to expect the students to travel and participate in intercultural projects in one of their undergraduate courses.

The second open ended question which is in line with one of the previous parts of this study asks classroom implementation considering cultural elements. In the fifth section of this study, the participants were asked to indicate their classroom practices regarding cultural components. In addition to these implementation techniques, the last question of this study expects the teachers to mention their own ways of implementing culture. The given answers to this question show that teachers encourage their students to have pen pals provide suggestions to students who are in middle school to join certain social media pages to get in touch with international students.

DISCUSSION

The need of integrating culture into language teaching programs is an undeniable fact in today's multicultural societies. However not all of the course policies address intercultural elements and their practices in classroom. Teaching programs may not represent the actual teaching atmosphere. During the teaching process teachers may adjust the program according to the teaching atmosphere and the learners' needs. That is why the gaps of language teaching curricula cannot be a reason for language teachers to neglect culture. The teachers should understand the benefits of having a multicultural approach without focusing on the English-speaking cultures. Teachers should also be aware of that, language teaching is a long process and not all the learners can achieve the expected outcomes at the same level. Thus, the same procedure applies for intercultural communicative competence. Not every learner will be competent at the same pace and level. In order to achieve best outcomes in teaching culture, language teachers should use creative and engaging methods which would encourage student engagement and awareness.

CONCLUSION

It has been a significant need to place cultural dimension among the other objectives of language teaching. Apart from the students' awareness and perceptions, the course materials should also be selected to serve the needs of intercultural teaching. Books' cultural implications should not be limited to the cultural aspects of the target language. In addition to local components, learners should be exposed to global components. Apart from the materials, teachers also play a great role in this process. Language teachers are expected to guide the students and become more competent everyday. This study aimed to analyze the opinions of Turkish EFL teachers in terms of teaching culture and their classroom implementations of this dimension. The results of this study are consistent with those of Atay et al, (2009). Finally, the results of this study show that Turkish teachers of English are mostly aware of the need of raising awareness of the students towards other cultures, the collected data also represent that teachers do not prioritize the cultural elements of the target language. But the result of the study also reveals that, while integrating culture, the teachers do not promote interaction and the use of technology in their classes. In order to enhance the classroom practices, the teachers can be trained more tackling this area of integration of culture, further studies can be conducted to research ways how to guide and train Turkish teachers of English in this area.



REFERENCES

- Atay, D., Kurt, G., Çamlıbel, Z., Ersin, P., & Kaslıoğlu, Ö. (2009). *The Role of Intercultural Competence in Foreign Language Teaching*. Available at: [https://dergipark.org.tr/tr/download/article-file/92286\[28.11.22\]](https://dergipark.org.tr/tr/download/article-file/92286[28.11.22])
- Baroudi, Faten. (2017). Intercultural Communicative Competence (ICC) in ELT Classrooms. 10.1016/0883-0355(96)80439-3.
- Girik Allo, Markus. (2018). Intercultural Communication in EFL Classrooms. *Ethical Lingua: Journal of Language Teaching and Literature*. 5. 159. doi: 10.30605/ethicallingua.v5i2.1036.
- Liddicoat, Anthony & Scarino, Angela. (2013). *Intercultural Language Teaching and Learning*. 10.1002/9781118482070.ch5.
- Sepora, T., Mahadi, T.S., & Jafari, S.M. (2012). Motivation, Its Types, and Its Impacts in Language Learning.
- Zhang, Xiaochi & Zhang, Jinjing. (2015). English Language Teaching and Intercultural Communication Competence. *International Journal for Innovation Education and Research*. 3. 55-59. 10.31686/ijer.vol3.iss7.394.



KIRGIZ HALK HEKİMLİĞİ UYGULAMALARINDA ‘MUMİYO’

Rifat Nergiz

Dr. Öğr. Elemanı, Kırgızistan-Türkiye Manas Üniversitesi Yabancı Diller Yüksekokulu ORCID:
0000-0001-7687-4343

Özet

Geleneksel tıbbı yahut halk hekimliğini kültürün ayrılmaz bir parçası olarak kabul edebiliriz. İnsan bilinci ve zihni geliştikçe bunlara paralel olarak da tıp ve diğer bilim dalları gelişmiştir. Ancak tıbbın, astronominin gelişim süreçlerinden evvel halk hekimliğinin ve astrolojinin varlığı yadsınamaz bir gerçekliktir. İlk insanlar hayvanların yaralanma sonrasında içgüdüsel bir davranışı olan yalanmayı zekâları ve gözlem güçleriyle araştırmış olduklarından olsa gerek kendilerini iyileştirmek için şifalı olabilecek her şeyi araştırma yoluna gitmişlerdir. İnsanlar elde ettikleri bilgileri deneme yanılma yoluyla biriktirip sözlü olarak nesilden nesle aktarmışlardır. Sağaltma yolu bazen şifalı olabilecek bitki, yağ, minerallerle olduğu kadar büyücüler ve şamanlar vasıtasıyla da gerçekleştirilmiştir. Bu nedenle eski zamanlardan beri doktor olarak adlandırılan büyücüler, şamanlar, şifacılar, sınıkcılar halk arasında oldukça saygı görmüştür.

Birçok faydalı özelliği olan şifalı bir mineral olduğuna inanılan *mumiyo* genellikle dağlık ülkelerde bulunmaktadır. *Mumiyo* Kırgızistan, Kazakistan ve Altayların dağlık bölgelerinden elde edilmekle birlikte İran, Burma, Moğolistan’da da bu minarele rastlanılmaktadır. *Mumiyo* mineralinin açığa çıkabilmesi için oksijenin az, havanın kuru olması gerekmektedir. Yükseklerde atmosfer basıncının az olması, ultraviolenin etkisi ve ani ısı değişimi bu minarelin ortaya çıkmasındaki ana unsurlardır. *Mumiyo* birçok kişinin hoşuna gitmeyecek bileşenlerden oluşmaktadır. Minarelin bileşenleri içinde hayvan dışkısı özellikle yarasa dışkısı ve bitki bileşenleri bulunan bu minarelin binlerce hastalığa iyi geldiği halk hekimlerince söylenmektedir. Bu minarelin en kıymetli olanları Altaylar ve Orta Asya’dır. Mumiyonun içeriğinde amino asitler, uçucu yağlar ve bazı vitaminler bulunmakla birlikte oluşumu şartlara göre değişkenlik göstermektedir. Alkolde çözünmeyen bu madde suda tamamen çözünmektedir. Halk hekimlerine göre *mumiyo* vücuttaki rejenerasyonu sağlamakta, karaciğer ve mide iltihaplanmasına iyi gelmekte, bağışıklığı güçlendirmekte ve verem tedavisinde kullanılmaktadır. Arıca en büyük nedenlerinden biri stres olan kekemeliğe de iyi geldiği düşünülmektedir. Halk inanışlarına göre psikoloji üzerinde dahi büyük etkisinin olduğu düşünülen *mumiyo* anksiyete kaynaklı uyku bozukluklarına da yardımcı olmaktadır. Bu çalışmada *mumiyo* hakkında genel inanışlara değinilmeye çalışılacak olup onun faydalarının yanı sıra zararlarına da değinilecektir.

Anahtar sözcükler: Mumiyo, halk hekimliği, minarel

“MUMİYO” IN KYRGYZ FOLK MEDICINE PRACTICES

Abstract

We can accept traditional medicine or folk medicine as an integral part of culture. As human consciousness and mind developed, medicine and other branches of science developed in parallel with them. However, before the development processes of medicine and astronomy, the existence of folk medicine and astrology is an undeniable reality. Since the first humans investigated the instinctive behavior of animals after injury, lying, with their intelligence and powers of observation, they sought everything that could be healing to heal themselves. People have accumulated the knowledge they have acquired through trial and error and have passed it on orally from generation to generation. The way of healing was carried out by sorcerers and shamans, as well as sometimes with herbs, oils, minerals that could be medicinal. For this reason, magicians, shamans, healers and cynics, who have been called doctors since ancient times, were highly respected among the people.



Believed to be a healing mineral with many beneficial properties, mumiyo is often found in mountainous countries. Although Mumiyo is obtained from the mountainous regions of Kyrgyzstan, Kazakhstan and Altai, this mineral is also found in Iran, Burma and Mongolia. In order for the mumiyo mineral to be released, the oxygen must be low and the air must be dry. The low atmospheric pressure at high altitudes, the effect of ultraviolet and the sudden temperature change are the main factors in the emergence of this mineral. Mumiyo consists of components that many people will not like. It is said by folk physicians that this mineral, which contains animal excrement, especially bat excrement, and plant components, is good for thousands of diseases. The most precious ones of this mineral are Altays and Central Asia. Although the content of mummy contains amino acids, essential oils and some vitamins, its formation varies according to the conditions. This substance, insoluble in alcohol, is completely soluble in water. According to folk physicians, mummy provides regeneration in the body, is good for liver and stomach inflammation, strengthens immunity and is used in the treatment of tuberculosis. It is also thought to be good for stuttering, one of the biggest causes of which is stress. According to folk beliefs, mummy, which is thought to have a great effect even on psychology, also helps anxiety-induced sleep disorders. In this study, general beliefs about mummy will be tried to be discussed and its benefits as well as its harms will be mentioned.

Key words: Mumiyo, folk medicine, mineral

Giriş

Halk hekimliği uygulamaları kültürün bir bileşeni ayrılmaz parçası olarak düşünüldüğünde insanlık ile paralel olarak gelişmiş ve yerini modern tıbbı devretmiştir. İlk etaplarda iyileşmek için hayvanları taklit eden insanoğlu bilinci geliştikçe edinmiş oldukları deneysel bilgileri nesilden nesle aktarmıştır. Bu sebepten dolayı eski devirlerde halk arasında bilge olduğu düşünülen ve tabip olarak adlandırılan şamanlar oldukça saygı görmüşlerdir. Elbette bu ampirik bilgiler her zaman insanlara fayda sağlamamış bazen de felaketlere neden olmuşlardır. Örneğin halk arasında baldıran otu diye bilinen ve oldukça zehirli olan bu bitki doğru kullanılmadığında kişiyi anında öldürebildiği bilinen bir gerçektir. Bu çalışmada mumiyonun kullanım alanlarına ve içeriğine değinilmeye çalışılacak olup onun hangi hastalıklara iyi geldiği hakkında bilgiler de verilecektir.

1. Mumiyonun içeriği ve iyi geldiği hastalıklar

Manas Destanı'ndan dahi adı geçen *mumiyo* umut verici bir halk hekimliği ilacıdır. Bir mineral olan *mumiyonun* klinik bulguları olmamasına rağmen birçok hastalığı tedavi edici özelliği olduğu yönünde görüşler mevcuttur. Ayrıca *mumiyonun* hastalık sonrası vücudun kendini yenilemesinde de etkili olduğu düşünülmektedir. Bu mineral daha çok dağlık ve ani ısı değişiminin etkili olduğu yerlerde bulunmaktadır. Ani ısı değişimleri ve ultraviolenin etkisiyle ortaya çıkan bu mineralin birçok vitamini ve elementi içinde bulundurmasına rağmen bileşimi hakkında kesin bilgiler yoktur (Cakıpova vd., 2018: 87). Manas Destanı'nda da adı geçen bu mineral kırık tedavisinde de kullanılmıştır (Sadibakasovna ve Mamasalievna, 2021: 135).

Bakıldığı mumiyo dört farklı şekilde karşımıza çıkmaktadır:

- 1) Altın mumiyo
- 2) Gümüş mumiyo
- 3) Bakır mumiyo (Bal)
- 4) Demir mumiyo (Kara) (2018: 87).

Mumiyonun rejenerasyon görevi dışında şu hastalıklara da iyi geldiği düşünülmektedir:

- 1) Karaciğerde ve mide de oluşan hasarı gidermede;
- 2) Bağışıklığı uyarmada;
- 3) Enfeksiyonları iyileştirmede;
- 4) Migren tedavisinde;
- 5) Kan şekerini dengelemede;
- 6) Arpacık tedavisinde;
- 7) Hemoroit tedavisinde;



mumiyonun oldukça etkili olduđu halk hekimlerince düşünölmektedir. Günümüzde reçeteyle satılmayan ve sadece günlük tecröbelere dayanılarak kullanılan bu minerale dünyaca önlü alimlerden olan İbn-i Sina, Muhammet Hüseyin Şerazi, Muhammet Tabip kitaplarında değinmiş ve bazı tespitlerde bulunmuşlardır. Bu alimlere göre de mumiyo akciđer hastalıklarına, cinselliđe, kardiyovasköler ve sinir sistemine etki eden bir mineral durumundadır (Cakıpova vd., 2018: 87).

Sonuç

Sonuç olarak modern tıptan umudun kesildiđi ve kronikleşen hastalıklar karşısında çaresiz kalan insanođlu hayatta kalmak için dođal olarak alternatif tıbbı ya da halk tıbbına yönelmektedir. Hiçbir kesinliđi olmayan Mumiyo mineralinden faydalanmaya çalışmak, ona ümit bağlamak da bu duruma örnek teşkil edebilmektedir. Gelişmemiş yahut gelişmekte olan ölkelerde bitkisel tedavinin yanı sıra ortopedik hatta cerrahi müdahalelerin de halk hekimlerince yapıldıđı bilinen bir gerçektir. Bu durum ancak modern tedavi yöntemlerine ulaşılmamakla açıklanabilmektedir. Ancak bakıldığında geleneksel tıbbı költürün bir bileşeni olarak kabul edip onun bir parçası olarak ele almakta fayda olacađı da su götürmez bir gerçektir.

Kaynakça

Cakıpova, D. K., Mukaşova, A. S., & Muratalieva, A. D. (2018). MUMİYO-MANAS DOORUNDA CANA BÜGÜN!. VESTNİK KGMA imeni İK AXUNBAEVA, 4(4), 86-90.

Sadibakasovna, G., Mamasalievna, N. (2021). “MANAS” EPOSUNDAGI DARI ÖSÜMDÜKTÖRDÜN KOLDONULUŞU CANA SÜRÖTTÖLÜŞÜ, VESTNİK CALAL-ABADSKOGO GOSUDARSTVENNOGO UNİVERSİTETA, s. 135.



KIRGIZCA VE TÜRKÇEDEKİ İKİ SESLİ ORTAK KÖK FİİLLERİN HAREZM TÜRKÇESİNDEKİ DURUMU

Ali ÇELİK

Kırgızistan-Türkiye Manas Üniversitesi, Yabancı Diller Yüksekokulu, Bişkek-Kırgızistan

Özet

Günümüzde Kırgızca ve Türkçe, Türk dilinin iki farklı grubunda yer almaktadır. Kırgızca, Kıpçak; Türkçe, Oğuz grubundadır. Bu sebeple iki dilde birtakım fonetik, morfolojik, semantik, leksikolojik ve sentaktik farklılıkların görülmesi olağan bir durumdur.

Hazırlanan bu çalışmanın temeli kök fiillere dayanmaktadır. Kök fiiller; iş, hareket, oluş bildirip herhangi bir ek almayan, yalnız başına anlamı olan kelimelerdir. Genellikle iki, üç; bazı örneklerde ise dört sesli olabilmektedir. Kök fiiller, fiilin yapısı içinde değerlendirilir.

Harezmi dönemine ait Türkçeye, Harezmi Türkçesi adı verilmektedir. Bu dönemin Türkçesi, Karahanlı Türkçesi temelinde gelişip Çağatay Türkçesine geçişte köprü görevini üstlenmiştir. Özellikle Kıpçak ve Oğuz Türkçelerinin etkisiyle gelişmiş ve Türk dili tarihi içinde önemli bir yazı dili halini almıştır.

Günümüzde Kırgızca ve Türkçedeki iki sesli (VK, KV ve VV) ortak kök fiillerin durumu Harezmi Türkçesi metinlerinde nasıldır? Hangi açıdan benzerlikleri ve farklılıkları vardır? Bunları tespit etmek için Harezmi Türkçesine ait belli başlı metinlerdeki kök fiiller, Kırgızca ve Türkçedeki ortak kök fiiller ile karşılaştırılmıştır. Ardından fonetik ve semantik olarak iki grup altında incelenmiştir. Kök fiillerin etimolojisine girilmemiş; ancak kimi yerlerde birtakım açıklamalar yapılmıştır.

Yapılan bu çalışmada Kıpçak ve Oğuz grubundan yer alan iki sesli ortak kök fiillerin art ve eş zamanlı olarak karşılaştırılıp elde edilen sonuçlar paylaşılacaktır.

Anahtar kelimeler: Kök Fiil, Kırgızca, Türkçe, Karşılaştırma, Harezmi Türkçesi

THE STATUS OF COMMON ROOT VERBS WITH DUAL VOICES IN KYRGYZ AND TURKISH IN KHWAREZM TURKISH

Abstract

Today, Kyrgyz and Turkish are in two different groups of the Turkic language. Kyrgyz is in the Kipchak but Turkish is in the Oghuz group. Therefore, it is normal to see some phonetic, morphological, semantic, lexicological and syntactic differences in the two languages.

The basis of this study is based on root verbs. Root verbs have work, movement, and occurrence but do not take any suffixes and have a meaning on their own. Usually two, three vowels but it can be four vowels in some examples. Root verbs are evaluated within the structure of the verb.

The language of the Khwarezm period is Khwarezm Turkish. The Turkish of this period developed on the basis of Karakhanid Turkish and acted as a bridge in the transition to Chagatai Turkish. It has developed especially under the influence of Kipchak and Oghuz Turkish and has become an important written language in the history of the Turkish language.

How is the situation of common root verbs with dual voices (VC, CV and VV) in Kyrgyz and Turkish in Khwarezm Turkish texts? In what ways do they have similarities and differences? In order



to determine these, the root verbs in the main texts of Khwarezm Turkish were compared with the common root verbs in Kyrgyz and Turkish. Then, it was examined under two groups as phonetic and semantic. Etymology of root verbs is not entered; however, some explanations have been made in some verbs.

In this study, dual voices common root verbs from Kipchak and Oghuz groups will be compared diachronically and simultaneously and the results will be shared.

Key words: Root Verb, Kyrgyz Language, Turkish Language, Comparison, Khwarezm Turkish.

Giriş

Dil alanında art ve eş zamanlı çalışmaların yapılması, dilin tarihi gelişimini görmek bakımından önemlidir. Özellikle bir dil, çeşitli kollara ayrılmış ve gelişme gösteriyorsa mutlaka diğer gruplarda olmayan birtakım özellikleri barındırır. Çünkü kimi ayrışmalar fakirleşmeden ziyade zenginleşmeye de sebep olabilir. Bu durum daha çok dilin konuşanların sosyolojik ve kültürel yaşamıyla ilgilidir.

Ele alınan konu günümüzdeki Kırgızca ve Türkçedeki iki sesli ortak kök fiillerin Harezmi Türkçesindeki durumları üzerine hazırlanmıştır. Bu iki dil, genel Türk dilleri içinde farklı gruplarda yer almaktadır. Kırgızca, Kıpçak; Türkçe, Oğuz grubundadır. Bundan dolayı iki dilde, filolojik bakımdan bazı fonetik, morfolojik, semantik, leksikolojik ve sentaktik farklılıklar görülmektedir.

Kök fiil denilince ne anlamalıyız? Bakışımız nasıl olmalıdır?

Kök fiiller; iş, hareket, oluş bildirip herhangi bir ek almayan, yalnız başına anlamı olan kelimelerdir. Çoğunlukla iki, üç; bazı örneklerde ise dört seslidirler. Fiilin yapısı içinde değerlendirilir. Elbette etimolojik çalışmalar neticesinde kimi kök fiillerin aslında türemiş fiil oldukları tespit edilebilseyse de, hazırlanan bu çalışmada herhangi bir kuşkuya düşürmeyecek olan iki sesli kök fiiller konu edilmiştir.¹

Harezmi dönemine ait Türkçeye, Harezmi Türkçesi adı verilmektedir. Kuzey Doğu Türkçesi olarak değerlendirilmektedir. Bu dönemin Türkçesi, 13. yüzyılda gelişmeye başlamış olup Karahanlı Türkçesinden Çağatay Türkçesine geçişte köprü görevini üstlenmiştir. Özellikle Kıpçak ve Oğuz Türkçelerinin etkisiyle gelişmiş ve Türk dili tarihi içinde önemli bir yazı dili halini almıştır (Ercilasun, 2012: 369; Gülensoy, 2000: 113; Ata, 2016: 17).

Yukarıda da belirtildiği üzere Kırgızca ve Türkçe, Türk dilleri içerisinde farklı gruplarda yer almaktadır. Birtakım benzerlikler yanında farklılıklar da vardır. Acaba iki sesli (VK, KV ve VV) ortak kök fiillerin durumu Harezmi Türkçesinde nasıldır? Benzerlikleri ve farklılıkları nelerdir? Bunları tespit etmek için Harezmi Türkçesine ait belli başlı metinlerdeki kök fiiller, Kırgızca ve Türkçedeki ortak kök fiiller ile karşılaştırılmıştır. Sonrasında fonetik ve semantik olarak iki grup altında incelenmiştir. Kök fiillerin etimolojisine girilmemiştir.

Fonetik Özellikler

¹ Aslında doğrudan “kök”ün ne olduğu hakkında Kotviç’in *İssledovaniye Po Altayskim Yazıkam* adlı eserine bakılmalıdır. Kendisi özellikle Altay dillerindeki kökün tespit edilebilmesi için, daha doğrusu mantıklı fikir yürütülebilmesi için, Altay dilleri grubuna diren dillerin ek-kök sisteminin iyi anlaşılması gerektiğini vurgulamıştır. Böyle bir tespit neticesinde birtakım sağlam fikirlere kavuşulabileceğini belirtmiştir (Kotviç, 1952: 33-46).



Kırgızca, Türkçe ve Harezmi Türkçesinde Fonetik Değişikliği Olmayanlar

Kırgızca, Türkçe ve Harezmi Türkçesinde hiçbir değişikliğe uğramayan ve farklı varyantı da olmayan 15 kök fiil tespit edilmiştir.

Kırg. aç- ~ Türk. aç- < Harz. aç- (NF, KE, ME, MM, HKT, HŞ, MN, İML, MN)

Kırg. al- ~ Türk. al- < Harz. al- (NF, KE, ME, MM, HKT, HŞ, MN, İML, AO, MN)

Kırg. aş- ~ Türk. aş- < Harz. aş- (NF, KE, ME, MM, HKT, HŞ, MN, İML, MN)

Kırg. at- ~ Türk. at- < Harz. at- (NF, KE, ME, MM, HKT, HŞ, İML, MN)

Kırg. az- ~ Türk. az- < Harz. az- (NF, KE, ME, MM, HKT, HŞ, İML)

Kırg. ez- ~ Türk. ez- < Harz. ez- (NF, KE, İML)

Kırg. il- ~ Türk. il- < Harz. il- (KE, ME, MM, HŞ, MN)

Kırg. oy- ~ Türk. oy- < Harz. oy- (KE, ME, İML)

Kırg. öp- ~ Türk. öp- < Harz. öp- (NF, KE, ME, MM, HŞ, İML, K, MN)

Kırg. öl- ~ Türk. öl- < Harz. öl- (NF, KE, ME, MM, HKT, HŞ, MN, İML, MN)

Kırg. ör- ~ Türk. ör- < Harz. ör- (NF, KE, ME, İML)

Kırg. uç- ~ Türk. uç- < Harz. uç- (NF, KE, ME, MM, HŞ, MN)

Kırg. ut- ~ Türk. ut-/üt- < Harz. ut- (İML, HŞ, MN)

Kırg. sı- ~ Türk. sı- < Harz. sı- (KE, ME, MM, HKT, HŞ)

Kırg. içi öt- ~ Türk. öt- < Harz. öt- (ME)

Kırgızca ve Türkçede Aynı Olup Harezmi Türkçesinde Farklı Fonetik Varyantlara Sahip Olanlar

Kırgızca ve Türkçede aynı olup Harezmi Türkçesinde hem aynı hem de farklı varyantlara sahip 8 kök fiil tespit edilmiştir.

Kırg. ak- ~ Türk. ak- < Harz. ak- (NF, KE, ME, MM, HKT, HŞ, MN, İML, MN) ~ ık- (HKT)

Kırg. as- ~ Türk. as- < Harz. aş- (KE) ~ as- (NF, KE, ME, HKT, MN, İML)

Kırg. de- ~ Türk. de- < Harz. tē- (KE, ME, MM) ~ te- (NF) ~ ti- (HKT, HŞ, AO, MN) ~ dē-(KE) ~ di- (HŞ, K, MN)



Kırg. ek- ~ Türk. ek- < Harz. ek- (NF, KE, HKT, İML) ~ êk- (MM) ~ ik- (HŞ)

Kırg. em- ~ Türk. em- < Harz. em- (NF, KE, ME, HKT, İML) ~ im- (HŞ)

Kırg. et- ~ Türk. et- < Harz. êt- (NF, ME, MM) ~ (KE, HKT, K) ~ it- (NF, KE, ME, HKT, HŞ, MN, K)

Kırg. iç- ~ Türk. iç- < Harz. iç- (NF, KE, ME, MM, HKT, HŞ, MN, İML) ~ iş- (NF)

Kırg. iter- ~ Türk. it- < Harz. it- (NF, KE, ME, HKT, HŞ, MN, K) ~ êt- (NF, ME, MM) ~ et- (KE, HKT, K)

Kırgızca, Türkçe ve Harezmi Türkçesinde Farklı Fonetik Varyantlara Sahip Olanlar

Kırgızca, Türkçe ve Harezmi Türkçesinde farklı varyantlara sahip 9 kök fiil tespit edilmiştir.

Kırg. ce- ~ Türk. ye- < Harz. ye- (NF) ~ yê- (KE, ME, MM) ~ yi- (HKT, MN, İML, HŞ). y# > c# değişmesi ilk olarak DLT’de görülür. Oğuz ve Kıpçaklar tarafından **c-**’ye çevrildiği belirtilmiştir. Ayrıca *y# > c#* değişmesi Kırgızca düzenli olup fonetik yapısının temel özelliğinden biridir (Karaağaç, 2018: 221).

Kırg. cuu- ~ Türk. yu- < Harz. yu- (NF, KE, ME, MM, HKT, İML, HŞ, MN) ~ yuw- (NF, HŞ) ~ yuv- (NF, KE) ~ yuy- (MN). Yukarıda verilen *y# > c#* değişmesi örneğine bu fiiller de gösterilebilir. Kırgızca için en bilinen fonetik özelliktir.

Kırg. oñ-/oño- ~ Türk. on- < Harz. oñ- (ME, MM, HKT, HŞ) ~ oñ- (ME). Kırgızca bazı anlam farklılıkları olmasına rağmen iki (VK=oñ-) ve üç sesli (VKV=oño-), Türkçede iki seslidir (VK=on-). Ayrıca **ñ** sesi günümüzde Kırgızca varlığını canlı bir şekilde sürdürürken, Türkçede kullanımdan düşmüştür. Daha çok ağızlarda görülen bir ses olmuştur.

Kırg. iy- ~ Türk. eğ- < Harz. ig- (HŞ) ~ eg- (KE, ME, HKT, İML) ~ êg- (MM). Özellikle eski Türkçe temelinde *g/ > y/* değişmesi Kıpçak grubuna ait dillerde sık görülürken, *g/ > ğ/* değişmesi de Türkçede sık görülen değişmedir (Karaağaç, 2018: 181-182).

Kırg. oo- ~ Türk. ağ- < Harz. ag- (KE, MM, HKT, HŞ, İML). g/ > ğ/ değişmesi de Türkçede sık görülen değişmedir (Karaağaç, 2018: 181-182). Fakat Kırgızca iki ünlüye dönme hadisesi daha çok **a** sesinin açıklık derecesiyle ilgilidir.

Kırgızca **oo-** şekline dönmesinde **a** sesinin **g** sesini yutması ve **a** sesinin *g > ğ > y > Ø* değişmesi neticesinde yuvarlaklaşıp **o** sesine dönüşmesi görülür.

Kırg. bol- ~ Türk. ol- < Harz. bol- (NF, KE, ME, MM, HKT, HŞ, MN, İML, Kİ MN) ~ ol- (K) y# > Ø# devirler öncesi bölünmeyi ve şiveleşmeyi gösterir (Karaağaç, 2018: 153).

Kırg. ür- ~ Türk. ürü- < Harz. ür- (KE, HKT, MN, İML, HŞ) ~ ügür- (ME).

Kırg. üz- ~ Türk. yüz- < Harz. üz- (NF, KE, MM, HŞ). Ø# > y# değişmesi tarihi devirlerden itibaren görülmektedir (Karaağaç, 2018: 221-222).

Kırg. ur- ~ Türk. vur- < Harz. ur- (NF, KE, ME, MM, HKT, İML, HŞ, KA).



Kırgızca ve Türkçede Olup Harezmi Türkçesinde Tespit Edilemeyenler

Kırgızca ve Türkçede olup Harezmi Türkçesinde olmayan 2 kök fiil tespit edilmiştir.

Kırg. **ık-** ~ *Türk.* **ih-** < *Harz.* -

k/ ~ h/ değişikliğinin ilk örnekleri Manihaist ve Budist metinlerinde görülmektedir. Yer yer Kıpçak dönemi eserlerinde görülmekle birlikte Oğuzcada eski metinlere göre daha sık; fakat düzensiz olduğu görülür (Karaağaç, 2018: 192).

Kırg. **eş-** ~ *Türk.* **eş-** < *Harz.* -

Anlam Özellikleri Üzerine Genel Değerlendirmeler

Ses bilgisi bölümünde gösterilen bütün fillerin anlam özellikleri yahut anlamlarıyla ilgili fikirler vermek yerine, seçilmiş olan bazı kök fiiller üzerinden bazı şeyler anlatılmaya çalışılacaktır.

Kırg. **as-**: Asmak, bir şeyi aşağıya sarkacak bir biçimde bir yere iliştip sarkıtmak. 2. Asmak, üzerine takınmak, kuşanmak. 3. Asmak, idam etmek.

Türk. **as-**: 1. Bir şeyi aşağıya sarkacak bir biçimde bir yere iliştip sarkıtmak. 2. Üzerine takınmak, kuşanmak. 3. Bir kimseyi boğazından ip vb. geçirip sallandırarak öldürmek, idam etmek. 4. Gitmek zorunda olunan bir yere özürsüz gitmemek. 5. Görevi olan bir işi özürsüz yapmamak.

Harz. **aş-**: asmak, idam etmek (KE) ~ **as-**: 1. İdam etmek, asmak 2. Sarkıtmak, asmak (NF, KE, ME, HKT, MN, İML).

Üç dile bakıldığında aynı anlamların kullanıldığı görülmektedir; ancak günümüz Kırgızcasında 3; Türkçesinde ise 5 anlam vardır.

Kırg. **aş-**: **I** 1. Aşmak. 2. Haddini aşmak, sınırı aşmak. 3. Geçmek. 4. Geçmek, daha iyi olmak. // **II** Aşmak, kısarakla çiftleşmek (aygır için).

Türk. **aş-**: 1. Yüksek, uzak veya geçilmesi güç bir yerin öte yanına geçmek. 2. Süre geçmek, bitmek, sona ermek. 3. Geçmek. 4. Erkek hayvan dişisiyle çiftleşmek. 5. argo Görünmeden kaçmak.

Harz. **aş-**: aşmak, geçmek, çıkmak, yükselmek, artırmak (NF, KE, ME, MM, HKT, HŞ, MN, İML, MN).

Üç dile bakıldığında aynı anlamların kullanıldığı görülmektedir; ancak Harezmi Türkçesinde “yükselmek” anlamı da kullanımdadır. Ayrıca Kırgızca ve Türkçede **aş-** için “hayvanların çiftleşmesi” anlamı varken, Harezmi Türkçesinde bu anlamın olmadığı görülür.

Kırg. **öp-**: Öpmek.

Türk. **öp-**: Sevgi, saygı, bağlılık, teşekkür belirtmek amacıyla dudaklarını bir şeye veya birine değdirmek.

Harz. **öp-**: öpmek (NF, KE, ME, MM, HŞ, İML, K, MN).



Üç dile bakıldığında aynı anlamların kullanıldığı görülmektedir.

Kırg. **cuu-**: 1. Yıkamak. 2. Akmak, akarak kaplamak. 3. Yeri yıkamak, yıkayarak tozu gidermek. 4. Kutlamak, hayırlamak. 5. Suçunu, günahını affettirmeye, kendini aklamaya çalışmak.

Türk. **yu-**: Yıkamak.

Harz. **yu-**: yıkamak, yumak (NF, KE, ME, MM, HKT, İML, HŞ, MN) ~ **yuw-**: yıkamak (NF, HŞ) ~ **yuv-**: yıkamak (NF, KE) ~ **yuy-**: yıkamak (MN)

Üç dile bakıldığında bu fiilin anlamında Kırgızcanın daha zengin olduğu görülür. Türkçede ve Harezmi Türkçesinde sadece “yıkamak” anlamı vardır.

Kırg. **ık-**: 1. Yanaşmak, yaklaşmak, bitişmek. 2. Yıkılmak, yığılmak, devrilmek, serilmek.

Türk. **ih-**: Deve çöküp oturmak.

Kırgızca ve Türkçede bulunan bu fiil Harezmi Türkçesinde tespit edilememiştir. Fiile bakıldığında Kırgızcadaki 2; Türkçede 1 anlama sahip olduğu görülür. Kırgızcadaki 2. anlam ile Türkçedeki anlam birbirine paralelken, Kırgızcanın 1. Anlamı Türkçede yoktur.

Kırg. **ür-**: Ürümek, ulumak, inilti, ağlar gibi ses çıkarmak.

Türk. **ürü-**: havlamak.

Harz. **ür-**: 1. üflemek, üflemek, ürmek, havlamak 2. Körüklemek (KE, HKT, MN, İML, HŞ)

Üç dile bakıldığında fiilin temel anlamları birbirine paraleldir. Türkçede sadece hayvana özgü bir anlam varken, Kırgızca ve Harezmi Türkçesinde insan dışı varlıklar içinde de kullanılabilir.

Kırg. **içi öt-**: İshal olmak, amel olmak, sürgün olmak.

Türk. **öt-**: 1. Kuş veya böcekler, değişik tonda ses çıkarmak. 2. Herhangi bir nesne, sürekli ses çıkarmak. 3. Üflemeli çalgıların sesi çıkmak. 4. argo Anlamsız, boş konuşmak. 5. argo (Sarhoş) kusmak. 6. argo Gizli bir şeyi söylemek.

Harz. **öt-**: (karın v.s.) gurlamak, ses çıkarmak (ME) ~ **ötür-**: ishal olmak (ME)

Üç dile bakıldığında **öt-** fiiliyle ilgili çeşitli anlamların olduğu görülür. Burada dikkat edilmesi gereken husus Kırgızca ve Harezmi Türkçesinde paralel anlamların olduğudur. Yani bir hastalık yahut insanın/hayvanın rahatsızlık halidir. Türkçede ise “ses çıkarma” anlamları olduğu gibi argo kullanımları da yer edinmiştir.

Sonuç ve Değerlendirme

Genel olarak değerlendirilmeye çalışılan Kırgızca, Türkçe ve Harezmi Türkçesindeki iki sesli kök fiillerin incelenmesi sonucu ortaya birtakım fikirler ortaya çıkmıştır. Bunları şöyledir:

- Art ve eş zamanlı çalışmalar için, kelime köklerinin incelenmesi ve araştırması önemlidir. Çünkü dilin ek-kök ilişkisi içinde yeni anlamlar kazanması, dilin gelişim sürecini de yakından



gösterir.

- Etimolojik çalışmaların titizlikle yapılması, kelimelerin en iyi şekilde incelenmesiyle mümkündür. Özellikle tarihi metinlerin detaylı şekilde incelenmesi, yapılacak olan sonraki çalışmaların temelini de güçlendirir. Sonrasında sağlam dayanaklarla yeri verilere ulaşılmasını mümkün kılar.
- Özellikle tarihî metinler temelinde incelemelerin yapılmasında, zaman ve sabır önemlidir. Uzun soluklu çalışmalarda dikkatli ve planlı işlerin yapılması, sonraki çalışmaların gelişmesine de katkı sağlayacaktır.
- Teknolojiden mutlaka faydalanılmalıdır. Özellikle dizin ve sözlük programlarının kullanılmasıyla işler daha rahat olacak ve az zamanda çok işin yapılmasına imkân sağlanacaktır.
- Ele alınan kelimelerde mutlaka, kelimeye ait toplumun dili, kültürü, sosyolojisi vd. incelenmelidir. Bunun neticesinde söz varlığındaki farklılıkların sonucu da ortaya çıkabilecektir.

KAYNAKLAR

ATA, A. (2014) **Çağatay Türkçesinin İlk Devresi, Harezmi-Altın Ordu Türkçesi**. Ankara: Ankara Üniversitesi Yayınevi.

ERCİLASUN, A. B. (2012) **Türk Dili Tarihi**. Ankara: Akçay Yayınları.

GÜLENSOY, T. (2000) **Türkçe El Kitabı**. Ankara: Akçağ Yayınları.

KARAAĞAÇ, G. (2018) **Türkçenin Ses Bilgisi**. İstanbul: Kesit Yayınları.

KOTVIÇ, V. (1952) **İssledovaniye Po Altayskim Yazıkam**. Moskva: İzdatel'stvo İnostrannoy Literaturı.

(2011) **Türkçe Sözlük**. Ankara: Türk Dil Kurumu.

(2017) **Kırgızca-Türkçe Sözlük I-II**. Bişkek: Kırgızistan-Türkiye Manas Üniversitesi Yayınları.



KOVID-19 KAYNAKLI DEVLET MÜDAHALELERİ İLE BORSA İSTANBUL ALT SEKTÖR ENDEKSELERİ ARASINDAKİ İLİŞKİLERİN TODA-YAMAMOTO NEDENSELLİK ANALİZİ İLE İNCELENMESİ

Gizay DAVER

Emrah ÖGET

Zonguldak Bülent Ecevit Üniversitesi, Devrek, Zonguldak

Özet

Bu çalışmada Kovid-19 salgının önlenmesine yönelik getirilen kısıtlamaların hangi sektörleri etkilediğini tespit edebilmek amaçlanmıştır. Bunun için Türkiye Cumhuriyeti tarafından Kovid-19 tedbirleri kapsamında uygulanan Devlet müdahaleleriyle Borsa İstanbul alt sektör endeksleri arasındaki nedensellik ilişkileri Toda-Yamamoto (1995) tarafından önerilen nedensellik analizi ile sınanmıştır. Sonuç olarak Devlet müdahalelerinin, Elektrik, Gayri Menkul Yatırım Ortaklığı, Kimyasal Petrol ve Plastik, Maden, Metal Ana, Sigorta, Taş Toprak, Toptan Satış ve Perakende ve Turizm sektörlerinin nedeni olduğu ortaya konulmuştur. Son olarak kısıtlamalara karşı endekslerin tepkisini görmek açısından etki-tepki fonksiyonlarına bakılmış ve ilgili dokuz alt sektör endeksinin tamamının Devlet Müdahalelerine karşı negatif bir tepki verdiği görülmüştür. Bu sonuçlara göre yatırımcıların benzer Devlet müdahaleleri karşısında ilgili dokuz sektörü iyi değerlendirmeleri ve şirket yöneticilerinin iş yapış şekillerini hızla dijital dönüşüme uyarlamaları tavsiye edilmektedir.

Anahtar Kelimeler: Kovid-19, Devlet müdahaleleri, Toda-Yamamoto, Sıkılık Endeksi

EXAMINATION OF THE RELATIONSHIP BETWEEN GOVERNMENT INTERVENTIONS CAUSED BY COVID-19 AND BORSA ISTANBUL SUB-SECTOR INDICES WITH TODA-YAMAMOTO CAUSALITY ANALYSIS

Abstract

This study, it is aimed to determine which sectors are affected by the restrictions imposed to prevent the Covid-19 epidemic. For this, the causality relations between the State interventions implemented by the Republic of Turkey within the scope of Covid-19 measures and Borsa İstanbul sub-sector indices were tested with the causality analysis proposed by Toda-Yamamoto (1995). As a result, it has been revealed that State interventions are the cause of Electricity, Real Estate Investment Trust, Chem Petrol Plastic, Mining, Basic Metal, Insurance, Nonmetal Mineral Product, Wholesale and Retail Trade, and Tourism sectors. Finally, the impulse-response functions were examined to observe the response of the indices to the restrictions, and it was seen that all nine related sub-sector indices had a negative reaction to Government Interventions. According to these results, it is recommended that investors make good use of the nine related sectors in the face of similar government interventions and that CEOs quickly adapt their business practices to digital transformation.

Keywords: Covid-19, Government interventions, Toda-Yamamoto, Stringency Index

1. Giriş



İlk Kovid-19 vakaları 31 Aralık 2019 tarihinde Dünya Sağlık Örgütüne (DSÖ) bildirildiğinde uluslararası piyasalarda büyük tepkiler meydana gelmemiştir. Kovid-19 İtalya'nın kuzeyine yayılmaya başladığında Dow Jones trendi değiştirmiş ve uluslararası piyasalarda büyük puan kayıpları yaşanmıştır. 9 Mart'ta İtalya ulusal bir karantina uygulaması gerçekleştirmiştir (Scherf, Matschke ve Rieger, 2022: 1) ve Dow Jones endeksi 23 Mart 2020 tarihine kadar şimdiye kadar ki en büyük düşüşünü yaşamıştır. Bununla birlikte Dünya Sağlık Örgütünün 11 Mart 2020'de Kovid-19'u küresel bir salgın olarak ilan etmesi salgının şiddeti ve bulaşıcı etkilerinin herkes tarafından bilinmesini sağlamış ve artan vaka sayıları ile birlikte Dünya genelindeki panik de artmıştır (Aggarwal, Nawn ve Dugar, 2021: 1). Bu gelişmeler neticesinde Kovid-19 küresel ekonomiyi ve finansal piyasaları etkilemekle kalmamış, aynı zamanda bir dizi hükümet müdahalelerinin de gerçekleştirilmesini zorunlu kılmıştır (Zaremba vd., 2020: 1-2). Dolayısıyla DSÖ'nün açıklamaları ile birlikte oluşan panik havası ve hükümetlerin uygulamış oldukları karantina uygulamaları Kovid-19'un finansal piyasalardaki olumsuz etkisini artırmıştır. Halka açık etkinliklerin iptal edilmesi, işyerlerinin gün içi çalışma sürelerinin kısaltılması, toplu taşıma yolcu kapasitesi ve seyahat kısıtlamaları, uçuşların iptal edilmesi ve/veya sınırlandırılması, sokağa çıkma kısıtlaması vb. kısıtlamalar nedeniyle çeşitli sektörlerde gelir kayıpları yaşanmış ve yatırımcıların yatırım kararlarında değişiklikler meydana gelmiştir. Nicola vd. (2020: 190), Kovid-19 kısıtlamaları ile birlikte artan ekonomik krizin ardından, ekonominin yeniden canlandırılması için hükümetlerin orta ve uzun vadeli planlamaya ve her sektör için ayrı ayrı ekonomik kalkınma planlarına ihtiyaç olduğunu söylemişlerdir. Hükümetler de işçiyi, işvereni ve ihracatı korumak ve çeşitli sektörlerdeki gelir kayıplarını azaltmak için bir takım ekonomik politikalar izlemişlerdir.

Literatür incelendiğinde Türkiye dışı piyasalarda Devlet müdahalelerinin hisse senedi piyasaları üzerindeki etkilerine sıklıkla çalışıldığı, ancak konu ile ilgili Türkiye piyasası için gerçekleştirilen çalışmaların sınırlı sayıda olduğu göze çarpmaktadır. Bu açıklamalar doğrultusunda Türkiye Cumhuriyeti Devleti'nin Kovid-19 tedbirleri kapsamında gerçekleştirmiş olduğu Devlet müdahaleleri ile Borsa İstanbul alt sektör endeksleri arasında bir nedensellik ilişkisinin bulunup bulunmadığının araştırılmasına gerek duyulmuştur. Bunun için öncelikle Türkiye'de uygulanan Devlet Müdahaleleri açıklanmış ve Oxford Üniversitesi Devlet Müdahale İzleyicisi tarafından geliştirilen Kovid-19 katılık/sıklık endeksi ile Borsa İstanbul alt sektör endeksleri arasındaki nedensellik ilişkileri Toda Yamamoto (1995) tarafından önerilen nedensellik analizi ile sınanmıştır. Son olarak Kovid-19 katılık/sıklık endeksi ile aralarında nedensellik ilişkisi tespit edilen alt sektör endeksleri için etki-tepki analizi gerçekleştirilmiş ve kısıtlamalardaki bir standart sapmalılık şok karşısında sektör endekslerinin verdiği tepkiler ortaya konulmaya çalışılmıştır.

Çalışmanın ikinci bölümünde Türkiye'de Kovid-19 tedbirleri kapsamında uygulanan Devlet Müdahalelerine değinilmiş, üçüncü bölümde konuyla ilgili Türkiye piyasalarına ve yurtdışı piyasalara yönelik gerçekleştirilen benzer çalışmalara yer verilmiş, dördüncü bölümde çalışmada kullanılan veriler ve kaynakları açıklanmış, beşinci bölümde çalışmanın yöntemi ve bulgularına yer verilmiş ve son bölümde çalışmanın sonuçlarına değinilerek bundan sonraki çalışmalar için önerilerde bulunulmuştur.



2. Türkiye’de Kovid-19 tedbirleri kapsamında uygulanan Devlet Müdahaleleri

Türkiye’de ilk Kovid-19 vakası 11 Mart 2020’de ortaya çıkmıştır (T.C. Sağlık Bakanlığı, 2021) ve virüse bağlı ilk ölüm ise 15 Mart 2020 tarihinde gerçekleşmiştir (TRT Haber, 2020). Ancak Türkiye hükümeti virüsün Çin’den sonra Güney Kore, ABD ve komşusu İran gibi ülkelerde görülmesiyle beraber hastalığın ülkeye girişini engellemeye yönelik politikalar izlemiştir. 10 Ocak 2020 tarihinde kurulan Bilim Kurulu’nun önerileri doğrultusunda havaalanlarına termal kameralar kurulmuş, vakaların yaşandığı ülkelerden Türk vatandaşları tahliye edilmiş ve yine bu ülkelerden gelen yolcular taramaya tabi tutulmuşlardır. Sağlık Bakanlığı’nın Türkiye’de görülen ilk Kovid-19 vakasını açıklamasının ardından Türkiye’de Kovid-19’un yayılmasını önlemek amacıyla ilk Devlet müdahaleleri (kısıtlamalar) devreye koyulmuştur (Deutsche Welle, 2021). Hükümetlerin Kovid-19 kaynaklı müdahaleleri Oxford Üniversitesi Devlet Müdahale İzleyicisi tarafından izlenmekte ve kullanılabilir verilere dönüştürülerek açık kaynaklı olan Our World in Data veri tabanında yayınlanmaktadır. Grafik 1, Türkiye’de Kovid-19 pandemisine yönelik Devlet müdahalelerinin, süreç içerisinde kronolojik olarak sıklığını göstermek için Our World in Data’dan alınan veriler doğrultusunda oluşturulmuştur.

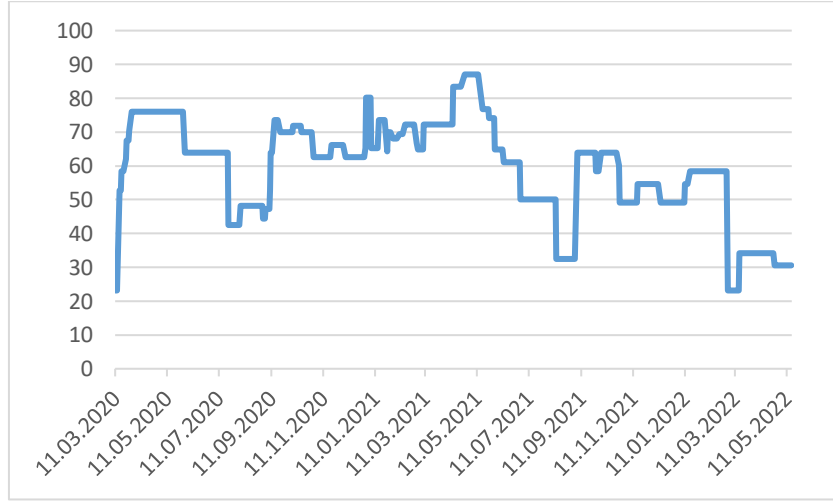

Grafik 1. Türkiye için tarihsel Kovid-19 katılım/sıklık endeksi

Grafik 1 incelendiğinde 11 Mart 2020 tarihinden 27 Mart 2020 tarihine kadar Devlet müdahalelerinin kademeli bir şekilde arttığı ve 1 Haziran 2020 tarihinden itibaren ise müdahalelerin kademeli bir şekilde azaltıldığı görülmektedir. Ancak artan vaka ve ölüm sayıları nedeniyle 2 Eylül 2020 tarihinden itibaren Devlet Müdahaleleri de artmış ve 3 Mayıs 2021 tarihinde en üst düzeye ulaşmıştır. 17 Mayıs 2021 tarihinden itibaren kademeli bir şekilde tekrar azaltılan müdahaleler 3 Eylül 2021 tarihinden sonra tekrar artırılmış ve 1 Mart 2022 tarihinden itibaren gevşetilmiştir.

Türkiye’de Kovid-19 tedbirleri kapsamında uygulanan Devlet Müdahaleleri Anadolu Ajansı, TRT Haber ve T.C. İçişleri Bakanlığı resmi sayfasından alınan bilgilerle kronolojik olarak açıklanmaya çalışılmış ve Our World in Data’dan alınan veriler doğrultusunda oluşturulan Grafik 1’in güvenilirliği ortaya konulmuştur. Anadolu Ajansı (2021) haberine göre; 9 Şubat 2020 tarihi gece yarısından itibaren, Türkiye ile İtalya, Güney Kore ve Irak arasındaki yolcu uçuşlarının durdurulduğu, 12 Mart 2020 tarihinden itibaren spor müsabakalarının seyircisiz oynanması kararı alındığı, 13 Mart 2020 tarihinde Umre ziyaretinden dönen vatandaşların karantinaya alındığı, 14 Mart 2020 tarihinde tüm hudut kapılarının, dokuz Avrupa ülkesinden gelen yolculara kapatıldığı, 16 Mart 2020 tarihinde ilkokul, ortaokul ve liselerde yüz yüze eğitimlere ara verildiği, 17 Mart 2020 tarihi gece yarısından itibaren vatandaşların toplu bir şekilde bir arada bulunmasını önlemek amacıyla birçok iş yerinin faaliyetlerine ara verildiği ve tiyatro, sinema, konser, nişan-düğün gibi etkinliklere kısıtlamaların getirildiği, 21 Mart 2020 tarihinde uçuş yasağı uygulanan ülke sayısının 68’e çıkarıldığı, beraber,



kuaför ve güzellik merkezlerinin faaliyetlerinin durdurulduğu, 22 Mart 2020 tarihi gece yarısı itibarıyla 65 yaş ve üstü vatandaşların sokağa çıkmalarının kısıtlandığı, 27 Mart 2020 tarihinde şehirlerarası seyahatlerin Valilik iznine bağlandığı ve özel sektörde esnek çalışma saatlerine geçildiği, 4 Nisan 2020 tarihinden itibaren 30 Büyükşehir ve Zonguldak illerine giriş-çıkışların yasaklandığı, sokağa çıkma kısıtlamasının 20 yaş altı gençleri de kapsayacak şekilde genişletildiği, 10-12 Nisan 2020 tarihleri arasında 30 Büyükşehir ve Zonguldak ilinde ilk sokağa çıkma kısıtlamasının uygulandığı görülmektedir. 1 Haziran 2020 tarihinden itibaren ise Kovid-19 salgını sürecinde "Yeni Normalleşme" dönemine girilmiş ve getirilen kısıtlamalar kademeli bir şekilde esnetilerek normalleşme süreci başlatılmıştır. Normalleşme süreci iki ay kadar sürmüştü, ancak artan vakalar nedeniyle ek kısıtlamalara gidilmiştir. 2 Eylül 2020 tarihinde ülke genelinde nikâh, düğün gibi etkinlikler kısıtlanmış, 20 Kasım 2020 tarihinden 4 Ocak 2021 tarihine kadar eğitim öğretim faaliyetlerine uzaktan eğitimle devam edilmesi kararı alınmış, restoranlarda paket servisi uygulamasına geçilmiş, sinemalar ve eğlence yerleri kapatılmış, hafta sonu sokağa çıkma saatlerine kısıtlamalar getirilmiş ve 65 yaş üstü ve 20 yaş altı için hafta içi günlerde sokağa çıkma saatlerinde sınırlamalara gidilmiştir. 2021 Ocak ayı ile beraber aşı ile ilgili çalışmalar hız kazanmış ve 2 Mart 2021 tarihinde “kontrollü normalleşme süreci” başlatılmıştır.

2 Mart 2021 tarihinde başlatılan “kontrollü normalleşme süreci” uzun sürmemiş T.C. İçişleri Bakanlığı tarafından yayınlanan genelge ile 14 Nisan 2021 tarihinden itibaren kısmi kapanma ve 29 Nisan 2021 tarihinden itibaren tam kapanma tedbirleri hayata geçirilmiştir (T.C. İçişleri Bakanlığı, 2021a; T.C. İçişleri Bakanlığı, 2021b). Bu dönemde Devlet müdahaleleri 83,33'lük bir değerle en yüksek noktaya ulaşmıştır. Bu kısıtlamalarla ve aşı çalışmalarıyla birlikte kısa sürede günlük vaka ve ölüm sayılarında ciddi bir düşüş gerçekleşmiş ve T.C. İçişleri Bakanlığı kalıcı normalleşmenin sağlanması için 16 Mayıs 2021 tarihinde bir genelge yayınlarak 17 Mayıs 2021-1 Haziran 2021 tarihleri arasında uygulanacak olan kademeli normalleşme dönemine ilişkin duyuru yayınlamıştır (T.C. İçişleri Bakanlığı, 2021c). Kısmi ve tam kapanma tedbirleri neticesinde vaka ve ölüm sayılarında ciddi bir düşüş yaşanmış ve 31 Mayıs 2021 tarihinde Haziran ayı boyunca uygulanacak olan kademeli normalleşme sürecinin ikinci etabı ve takiben Temmuz ayı boyunca uygulanacak olan kademeli normalleşme sürecinin üçüncü etabı kapsamında tedbirler açıklanmıştır (TC. İçişleri Bakanlığı, 2021d; T.C. İçişleri Bakanlığı, 2021e). Atılan bu adımlarla birlikte Ağustos 2021 döneminde Devlet müdahaleleri şimdiye kadarki en düşük seviyeye gerilemiştir. 6 Eylül 2021'den itibaren aşı olmayanlara negatif sonuçlu PCR testi zorunluluğunun getirilmesiyle (TRT Haber, 2021) Kovid-19 katılık endeksi tekrar artışa geçse de bu zorunluluklar 3 Mart 2022 tarihinde sonlandırılmış (TRT Haber, 2022a), maske kullanım zorunluluğunun da kaldırılmasıyla (TRT Haber, 2022b) birlikte Kovid-19 tedbirleri kapsamında uygulanan Devlet Müdahaleleri dikkate değer bir oranda azalmıştır

3. Literatür

Kovid-19 salgınının Dünya Sağlık Örgütü tarafından pandemi olarak ilan edilmesinden bu yana Kovid-19'un piyasalar üzerindeki etkileri de araştırmacılar tarafından yoğun bir şekilde ele alınmıştır. Konuyla ilgili Türkiye piyasalarına yönelik yapılan çalışmalara bakıldığında genel olarak vaka ve ölüm sayılarıyla Borsa İstanbul endeksleri arasındaki ilişkilerin incelendiği görülmüştür (Barut ve Yerdelen-Kaygın, 2020; Atıcı-Ustalar ve Şanlısoy, 2020; Gümüş ve Hacıevliyagil, 2020; Tayar vd., 2020; Korkut vd., 2020; Özdemir, 2020; Ertuğrul-Ayrancı ve Arı, 2021; Şenol ve Otçeken, 2021; Yıldız-Contuk, 2021). Diğer taraftan Türkiye'de Kovid-19 kaynaklı çeşitli Devlet müdahalelerinin piyasalar üzerindeki etkilerine yönelik sınırlı sayıda çalışmaya rastlanılmıştır (Çetin, 2020). Bu çalışmalardan Çetin (2020), çok değişkenli bir regresyon modeli kullanarak Türkiye'deki sosyal mesafe uygulamaları olarak; sokağa çıkma, yurtiçi ve yurtdışı seyahat kısıtlaması uygulanan günlerin sayısını açıklayıcı değişkenler olarak kullanmış ve sosyal mesafe uygulamasının BİST100



endeksini negatif olarak etkilediği sonucuna ulaşmıştır. Diğer taraftan açıklanan yeni Kovid-19 vakaları sayısının BİST 100 endeksiyle pozitif ilişkili olduğu tespit edilmiştir.

Kovid-19 kaynaklı vaka ve ölüm sayılarına odaklanılan çalışmalara bakıldığında; Barut ve Yerdelen-Kaygın (2020), Kovid-19 vaka ve ölüm sayılarıyla hastalığın en çok görüldüğü 11 ülkenin ulusal borsa endeksleri arasındaki ilişkileri Bayer ve Hanck (2012) eşbütünleşme analizi ile incelemiştir. Sonuç olarak Kovid-19 toplam vaka sayısı ile BİST100, FTSE MIB, IBEX35, AEX ve Shanghai endeksleri arasında eşbütünleşme ilişkisi tespit edilirken, DAX, CAC 40, BEL 20, SMI, FTSE 100 ve DOW 30 endeksleri için eşbütünleşme ilişkisi bulunmamıştır. Atıcı-Ustalar ve Şanlısoy (2020), Türkiye’de Kovid-19 vaka sayıları ile BIST100 arasındaki ilişkiyi genelleştirilmiş otoregresif koşullu değişen varyans (GARCH) modeli yardımıyla incelemişler ve Kovid-19 günlük vaka sayılarındaki artışın BIST100 getirileri üzerinde azaltıcı bir etkiye sahip olduğunu tespit etmişlerdir. Gümüş ve Hacıevliyagil (2020), Kovid-19 kaynaklı günlük ölüm ve vaka sayılarıyla Borsa İstanbul Turizm ve Ulaştırma endeksleri arasındaki ilişkileri ARDL sınır testi yaklaşımı ile incelemişler ve sonuç olarak vaka sayılarıyla ilgili endeksler arasında anlamlı bir ilişki bulamamışlar, ancak ölüm sayılarıyla endeksler arasında uzun dönemli ters yönlü bir ilişki tespit etmişlerdir. Tayar vd. (2020), Türkiye’de Kovid-19 kaynaklı aktif vakalardaki günlük değişim ile Borsa İstanbul sektör endeksleri arasındaki ilişkileri basit lineer regresyon analizi ile incelemişler ve sonuç olarak Kovid-19 vakalarındaki değişimin Elektrik, Ulaştırma, Mali, Sınai ve Teknoloji sektör endeksleri üzerinde yüksek düzeyde olumsuz etkilerinin olduğunu bulmuşlardır. Korkut vd. (2020), Kovid-19 günlük vaka ve ölüm sayılarının Borsa İstanbul Turizm Endeksi üzerindeki etkisini ARDL sınır testi yaklaşımı ile incelemişler ve sonuç olarak hem vaka hem de ölüm sayılarının Turizm endeksi ile eşbütünleşik olduğu sonucuna ulaşmışlardır. Uzun dönemli katsayı tahminlerine göre değişkenler arasında pozitif yönlü bir ilişki tespit edilirken, kurulan kısa dönem denkleminde Covid-19’un BIST Turizm endeksinde yer alan firmaların hisse senedi fiyatlarını negatif olarak etkilediği tespit edilmiştir. Özdemir (2020), Kovid-19 vaka ve vefat sayıları ile BIST Mali, Sınai, Hizmet ve Teknoloji sektör endeksleri arasındaki asimetrik ilişkiyi Hatemi-J asimetrik nedensellik testi ile incelemiş ve sonuç olarak mali ve hizmet endekslerinin vaka sayısındaki şoklarla, sınai ve teknoloji endekslerinin ise vaka ve vefat sayısındaki şoklarla ilişkili olduğunu tespit etmiştir. Ertuğrul-Ayrancı ve Arı (2021), Kovid-19 vaka sayıları ile BIST mali, hizmet, sanayi, turizm ve ulaştırma endeksleri arasındaki ilişkileri Bayer-Hanck (2013) eşbütünleşme analizi ile araştırmışlardır. Sonuç olarak Kovid-19 vaka sayısı ile hizmet, sanayi, turizm ve ulaştırma endeksleri arasında uzun dönemli bir ilişkinin varlığı tespit edilirken, katsayı tahminleri bu ilişkilerin negatif yönlü olduğunu göstermiştir. Ayrıca kısa dönemli sapmaların ele alındığı hata düzeltme modelinde mali endeksin dışında kalan tüm endeksler için anlamlı ve negatif katsayılar bulunmuş ve kısa dönemde vaka sayılarının endeksler üzerinde uzun döneme kıyasla daha büyük etkisinin olduğu sonucuna ulaşılmıştır. Şenol ve Otçeken (2021), Kovid-19 vaka ve vefat sayıları ile BIST hizmet, mali, sanayi ve ticaret endeksleri arasındaki ilişkiyi Johansen eşbütünleşme ve Todo-Yamamoto nedensellik analizleri ile incelemişlerdir. Eşbütünleşme analizi sonucunda Kovid-19 vaka ve vefat sayıları ile mali ve sanayi endeksleri arasında uzun dönemli bir ilişkinin varlığı ortaya konulmuştur. Todo-Yamamoto nedensellik analizi sonucunda ise Kovid-19 vefat sayılarından mali ve sanayi endekslerine doğru bir nedensellik ilişkisi tespit edilmiştir. Yıldız-Contuk (2021), Kovid-19 vaka sayıları ile BIST toplam işlem hacmi arasındaki ilişkiyi Dağıtılmış Gecikmeli Otoregresif Sınır Testi ile incelemiş ve sonuç olarak kısa vadede Kovid-19’un borsa işlem hacmi üzerinde negatif yönde ve uzun vadede ise pozitif yönde bir etkisinin olduğu sonucuna ulaşmıştır.

Türkiye dışı piyasalar üzerine yapılan çalışmalar incelendiğinde ise Devlet müdahalelerinin borsalar üzerindeki etkilerini ölçmek için çok sayıda çalışmanın gerçekleştirildiği ve bu çalışmalarda Oxford Kovid-19 Devlet Müdahale İzleyicisi tarafından geliştirilen sıklık/katılık endeksinin (Stringency Index) sıklıkla kullanıldığı görülmüştür (Zarembo vd., 2020; Aggarwal, Nawn ve Dugar, 2021; Yang



ve Deng, 2021; Bakry vd., 2022). Bu çalışmalarda incelenen uluslararası piyasalar ve inceleme dönem ve yöntemlerindeki farklılıklar nedeniyle gelişmiş ve gelişmekte olan piyasalarda farklı sonuçlar elde edilmekle birlikte genel olarak gelişmekte olan ülkelerde Devlet müdahalelerinin, Kovid-19'un piyasalar üzerindeki negatif etkisini ve oynaklığı artırdığı sonucuna ulaşıldığı söylenebilmektedir. Zarembo vd. (2020), Devlet müdahalelerinin uluslararası hisse senedi piyasalarının oynaklığı üzerindeki etkisini araştırmak için Kovid-19 sıklık endeksini kullanmışlar ve 67 farklı ülkenin yer aldığı bir panel veri modeli üzerinde çalışmışlardır. Sonuç olarak Kovid-19 pandemisinden bağımsız bir şekilde, Devlet müdahalelerinin uluslararası hisse senedi piyasalarındaki oynaklığı önemli ölçüde artırdığını ortaya koymuşlardır. Aggarwal, Nawn ve Dugar (2021), Kovid-19 pandemisine yönelik olarak gerçekleştirilen Devlet müdahalelerinin ve pandeminin neden olduğu paniğin büyüme güncellemesi ve risk primi kanalıyla en likit hisse senedi piyasasına sahip on iki ülkenin hisse senedi getirileri üzerindeki etkilerini regresyon modeli kullanarak incelemişlerdir. Sonuç olarak paniğin büyüme güncellemesi kanalı yoluyla getirileri etkilemediği, Devlet müdahalelerindeki artışın ise, aynı kanaldan getiriler üzerinde olumsuz bir etkisinin bulunduğunu ortaya koymuşlardır. Diğer taraftan risk primi kanalı yoluyla yinelenen çalışmada, paniğin hisse senedi getirilerini olumsuz etkilediği, Devlet müdahalelerinin ise risk primi kanalı yoluyla hisse senedi getirilerini olumlu etkilediği sonucuna ulaşılmıştır. Yang ve Deng (2021), Kovid-19'un ve Devlet müdahalelerinin 20 OECD ülkesinin hisse senedi getirileri üzerindeki etkilerini panel regresyon modeli kullanarak incelemişler ve sonuç olarak hisse senedi getirilerinin, teyit edilen vaka sayısındaki artışa önemli ölçüde olumsuz tepki verdiğini, Devlet müdahalelerinin ise KOVİD-19'un hisse senedi getirileri üzerindeki olumsuz etkisini artırdığını ortaya koymuşlardır. Bakry vd. (2022), Kovid-19 ölüm ve vaka sayıları ile Devlet müdahalelerinin 24 gelişmekte olan ve 15 gelişmiş finansal piyasanın oynaklığı üzerindeki etkilerini asimetrik GJGARCH tahminine dayanan panel veri modeli ile araştırmışlar ve sonuç olarak her iki piyasada da oynaklık ile KOVİD-19 teyitli vakalar arasında pozitif ve anlamlı bir ilişki tespit etmişlerdir. Ölüm oranının ise yalnızca gelişmekte olan piyasalarda oynaklığı artırdığı bulunmuştur. Diğer taraftan gelişmekte olan piyasalarda oynaklık ile Devlet müdahaleleri arasında güçlü bir pozitif ilişki bulunurken, gelişmiş piyasalarda bu değişkenler arasında negatif bir ilişkinin olduğu ortaya konulmuştur.

Literatürden de anlaşılacağı üzere Kovid-19 kaynaklı Devlet müdahalelerinin Dünya genelindeki piyasalara etkisi sıklıkla çalışılmasına rağmen Türkiye piyasası ile ilgili gerçekleştirilen çalışmalar Kovid-19 vaka ve ölüm sayılarının piyasalar üzerindeki etkisiyle sınırlı kalmaktadır. Dolayısıyla literatüre katkı sağlaması açısından Kovid-19'un yayılmasını önlemeye yönelik gerçekleştirilen Devlet müdahaleleri ile Borsa İstanbul alt sektör endeksleri arasındaki nedensellik ilişkilerinin ortaya konulmasına gerek duyulmuştur.

4. Çalışmada Kullanılan Veriler

Çalışmada Oxford Korona Virüs Devlet Müdahale İzleyicisi Katılık/Sıklık endeksi ile Borsa İstanbul alt sektör endeksleri ilişkisi değerlendirilmiştir. Kullanılan endeksler ve endeks sürekliliğiyle ilgili bilgiler bu bölümde sunulmaktadır. Teknik özet olarak sunulmak gerekirse Borsa İstanbul bünyesinde Endekslerin sürekliliğinin sağlanmasına yönelik işlemler Endeks ve Veri Bölümü tarafından yapılmakta, Borsa İstanbul Genel Müdürlüğü'nce onaylanmaktadır.

Borsa İstanbul Endeks ve Veri Direktörlüğü, 2018 BİST Pay Endeksleri Temel Kuralları'ndan alınan bilgilere göre;

“Sektör Endeksleri ve Alt Sektör Endeksleri, Menkul Kıymet Yatırım Ortaklıkları hariç olmak üzere, Borsa İstanbul pazarlarında işlem gören şirketlerin paylarından oluşur.... Sektör değişikliğine neden olacak şekilde faaliyet konusu değişen şirketler, yeni



faaliyetlerinin fiilen başladığına ilişkin bildirim KAP'ta yayımlandığı haftayı izleyen haftanın ilk iş günü geçerli olacak şekilde eski sektör endekslerinden çıkarılarak yeni sektör endekslerine alınır.”

Borsa İstanbul pay endeksleri temelde iki farklı yöntemle hesaplanmaktadır. Söz konusu yöntemler ağırlıklandırma teması kapsamında piyasa değeri ağırlıklı olan ve piyasa değeri ağırlıklı olmayan şeklinde sınıflandırılır. İşlem görmekte olan payların fiyat ve getiri performanslarının gruplar halinde ölçülmesi için piyasa değeri ağırlıklı endekslerin kullanımı tercih edilmektedir. Endeks dönemi içerisinde çeşitli sebeplerle endekse dâhil edilen payların ağırlıklarının değişmesine imkân veren endeksler piyasa değeri ağırlıklı endekslerdir. Endeks dönemi boyunca endeks temasına uygun olarak standart bir ağırlık çerçevesinde işlem gören payların gruplar halinde getiri performansının ölçülmesine imkân veren endeksler piyasa değeri ağırlıklı olmayan endekslerdir. Bu endekslerde payların endeks içerisindeki ağırlıklarının sadece payın fiyatındaki hareketlere bağlı olarak değişmesi sağlanmaktadır. Olağan işleyiş haricindeki sermaye değişikliği, birleşme ve bölünme gibi bozucu eylemlerde ise endekste gerekli düzeltmeler yapılarak etkisizleştirme sağlanmaktadır (Borsa İstanbul A.Ş., 2022b; Borsa İstanbul Endeks Direktörlüğü, 2022b, 2022a).

Bunun haricinde fiyat endeksi ve getiri endeksi ayrıştırması bulunmaktadır. Fiyat endeksi, ödenen temettünün portföy dışına çıkarıldığı varsayımına dayanarak hesaplama ve sürekliliğinin sağlanması için ödenen temettüyü dikkate almamaktadır. Dolayısıyla bu endeks sadece payların fiyatlarındaki ortalama değişimi göstermektedirler. İkinci ayırmada temettünün dikkate alındığı getiri endeksleri bulunmaktadır. Getiri endeksleri, sürekliliğinin sağlanmasında ödenen temettünün endekse dahil edildiği varsayımına dayanarak düzeltme yapılan endekslerdir. Getiri endekslerinde iki bileşen dikkate alınmaktadır. Birincisi payların fiyatlarındaki ortalama değişim, ikincisi ise temettüden dolayı elde edilen kazançtır (Borsa İstanbul A.Ş., 2022c).

Oxford Korona Virüs Devlet Müdahale İzleyici (The Oxford Coronavirus Government Response Tracker-OxCGRT) projesi kapsamında bir Katılık/Sıkılık Endeksi hesaplanmaktadır. Bu endeks önceden belirlenmiş dokuz ölçüte verilen yanıtların birleşik bir ölçüsü olarak hesaplanmaktadır. Endeks sonucunda çıkan değer 0 en gevşek puanı ve 100 en sıkı/katı puanı temsil etmek üzere kullanılmakta olup, sayı ne kadar büyük hesaplanırsa ülke tedbirlerinin o derece katı olduğu belirlenmektedir (Roser, 2021).

Sıkılık Endeksini hesaplamak için kullanılan dokuz ölçüt; okul kapanışları, işyeri kapanışları, halka açık etkinliklerin iptali, halka açık toplantılar üzerindeki kısıtlamalar, toplu taşımanın kapanması, evde kalma gereksinimleri, kamuyu bilgilendirme kampanyaları, iç seyahat hareketleri üzerindeki kısıtlamalar ve uluslararası seyahat kontrolleri olarak sıralanmaktadır (Our World in Data, t.y.).

GitHub üzerinden açık kaynak olarak sunulmakta olan endeks ve endeks hesaplama yöntemi zaman içerisinde, pandemi seyrinde, gelişmiştir. Değişikliklerinin proje sürecinde gelişimini incelemek mümkün olup, değişikliklerin gözlemlendiği tarihler süreklilik incelemesi için listelenmektedir (Phillips, 2022). Endeks metodolojisindeki değişiklikler süreklilikte kopmalara neden oluyorsa sonuçları etkileyeceğinden düzeltme yollarının aranması gerekecektir (Our World in Data, 2022; Phillips, 2022)

25.05.2020; 22.10.2020; 29.10.2020; 09.12.2020; 14.01.2021; 15.03.2021; 05.05.2021; 27.09.2021 tarihleri endeks metodolojisinde gerçekleştirilen değişikliklerin tarihleridir. Bu çalışmada endeks metodolojisindeki değişikliklerin endeks sürekliliğinde kopmalara neden olup olmadığı endeks metodolojisi değişikliğinden önceki günle sonraki gün arasındaki endeks değişim değerinin 20% den fazla olup olmadığı ile sınılanmıştır. Bu kabulün gerekçesi ülkelerin uygulamaya aldığı politikaların



finansal serilerde gözlenen volatilité şeklinde deęil, bir politikanın uygulamaya alınması şeklinde 0 veya 1 ile ifade edilecek nitelikte olmasýdır.

27.07.2020 tarihinde TL cinsi BIST Pay ve Müşteri Endekslerinden iki sıfır atılmıştır. Bu nedenle bu tarihten önceki dosyalardaki endeks değerlerinin 100'e bölünerek ve bölen değerlerinin 100'le çarpılarak kullanılmasının gereklilięi ifade edilmektedir. Endekslerden sıfır atılması sonucu VİOP'ta işlem gören endeks vadeli işlem ve opsiyon sözleşmelerinde de deęişiklikler yapılmıştır ve 27.07.2020 tarihinden önceki VİOP dosyaları kullanılırken de bu hususa dikkat edilmesi gerekmektedir (Borsa İstanbul A.Ş., 2020).

Borsa İstanbul'a ait tarihsel veriler ve bazı referans veriler "DataStore" sayfası üzerinden" akademik başvuru ile sağlanmıştır. Kopmaların incelenmesi adına analiz kapsamına giren seri okunmuş ve metodoloji deęişikliklerinin gerçekleştięi günler ve öncesindeki deęişim oranları incelenmiştir. Bulgular, daha önce belirtilenen sına ma çerçevesinde kopma olmadığı yönündedir.

Tablo 1'de ulusal endeks ve çalışma kapsamında kullanılan alt sektör endeksleri sunulmuştur. Endeks kısaltma ve isimleri ile endeks başlangıç tarih ve başlangıç değerleri toplu olarak görülmektedir. Çalışma kapsamında kullanılan tüm endeksler, yöntem ve metodolojik açıdan pay senetleri için fiyat endeksleridir (Borsa İstanbul A.Ş., 2022d).

Tablo 1. BIST endekslerine ilişkin bilgiler

Endeks Kodu	Endeksler	Endekslerin İngilizce İsimleri	Endeksin Başlangıç Deęeri
XGIDA	BIST GIDA ICECEK	BIST FOOD BEVERAGE	(27.12.1996=10.4591)
XKMYA	BIST KIMYA PETROL PLASTIK	BIST CHEM. PETROL PLASTIC	(27.12.1996=10.4591)
XMADN	BIST MADENCILIK	BIST MINING	(01.02.2013=660.3019)
XMANA	BIST METAL ANA	BIST BASIC METAL	(27.12.1996=10.4591)
XMESY	BIST METAL ESYA MAKINA	BIST METAL PRODUCTS MACH.	(27.12.1996=10.4591)
XKAGT	BIST ORMAN KAGIT BASIM	BIST WOOD PAPER PRINTING	(27.12.1996=10.4591)
XTAST	BIST TAS TOPRAK	BIST NONMETAL MIN. PRODUCT	(27.12.1996=10.4591)
XTEKS	BIST TEKSTIL DERI	BIST TEXTILE LEATHER	(27.12.1996=10.4591)
XELKT	BIST ELEKTRIK	BIST ELECTRICITY	(27.12.1996=10.4591)
XILTM	BIST ILETISIM	BIST TELECOMMUNICATION	(24.07.2000=137.1988)
XINSA	BIST INSAAT	BIST CONSTRUCTION	(01.02.2013=502.8199)
XSPOR	BIST SPOR	BIST SPORTS	(31.03.2004=201.9083)
XTCRT	BIST TICARET	BIST W. AND RETAIL TRADE	(27.12.1996=10.4591)
XTRZM	BIST TURIZM	BIST TOURISM	(27.12.1996=10.4591)
XULAS	BIST ULASTIRMA	BIST TRANSPORTATION	(27.12.1996=10.4591)
XBANK	BIST BANKA	BIST BANKS	(27.12.1996=9.1447)
XSGRT	BIST SIGORTA	BIST INSURANCE	(27.12.1996=9.1447)
XFINK	BIST FIN. KIR. FAKTORING	BIST LEASING FACTORING	(27.12.1996=9.1447)
XHOLD	BIST HOLDING VE YATIRIM	BIST HOLD. AND INVESTMENT	(27.12.1996=9.1447)
XGMYO	BIST GAYRIMENKUL Y.O.	BIST REAL EST. INV. TRUSTS	(28.12.1999=211.8077)
XBLSM	BIST BILISIM	BIST INF. TECHNOLOGY	(30.06.2000=144.6612)

Kaynakça: (Borsa İstanbul A.Ş., 2022a)



5. Yöntem ve Bulgular

Bu çalışmada Kovid-19 kısıtlamalarıyla Borsa İstanbul alt sektör endeksleri arasındaki nedensellik ilişkileri Toda Yamamoto (1995) tarafından önerilen nedensellik analizi ile sınanmıştır. Bunun nedeni çalışmada kullanılan değişkenlerin aynı seviyede durağan olarak bulunamamasıdır. Zaman serileri ile gerçekleştirilen klasik analiz yöntemlerinde değişkenlerin durağan olduğu varsayılmaktadır. Durağanlık, zaman serisi ortalama ve varyansının zamandan bağımsız olduğu anlamına gelmektedir (Çil-Yavuz, 2011: 240-241). Granger (1969) nedensellik testi, VAR analizi ile bağımsız bir değişkenin gecikmeli değerlerinin bağımlı değişkenin şimdiki değerini etkileyip etkilemediğini incelemek için literatürde yaygın olarak kullanılmaktadır. Buna karşın, Rossi ve Wang (2019: 2), VAR tabanlı istatistiksel analizlerde zaman içinde değişikliklere izin verilmesinin önemine vurgu yaparak, geleneksel Granger-nedensellik testinin durağanlık varsayımı gerektirmesinden dolayı, durağan olmayan serilerin varlığında güvenilir olmadığını ve yanlış çıkarımlara yol açabileceğini söylemişlerdir. Toda Yamamoto (1995) nedensellik testinde ise durağanlık varsayımı ve değişkenler arasında herhangi bir eşbütünlük ilişkisi aranmamakla beraber değişkenlerin düzey değerleriyle çalışılmasına imkân verilmektedir. Toda Yamamoto testinde, öncelikle VAR modeline dayalı optimum gecikme uzunluğu (p) belirlenmekte ve serilerin maksimum durağanlık seviyeleri (d_{max}) ile toplanarak yeni bir VAR modeli oluşturulmaktadır (Gazel, 2017: 291-292). Bu iki değer bilinmesi veri kaybının engellenmesini ve düzey verileri ile daha tutarlı sonuçların elde edilmesini sağlamaktadır (Meçik ve Koyuncu, 2020: 2626). Toda Yamamoto yöntemine göre çalışmamız için nedenselliğin araştırılacağı değişkenlere ait verilerin düzey değerlerinin kullanıldığı model, bir (1) numaralı denklemde gösterilmiştir;

$$LN(Endeks)_t = a_0 + \sum_{i=1}^{p+d_{max}} a_{1,i} LN(Endeks)_{t-1} + \sum_{i=1}^{p+d_{max}} a_{2,i} LNCOV_{t-1} + \varepsilon_{1,t} \quad (1)$$

Endeks = XBANK, XBLSM, XELKT, XFINK, XGIDA, XGMYO, XHOLD, XILTM, XINSA, XKAGT, XKMYA, XMADN, XMANA, XMESY, XSGRT, XSPOR, XTAST, XTCRT, XTEKS, XTRZM, XULAS

Bir (1) numaralı denklem MWALD testi hipotezleri kullanılarak gerçekleştirilmiş ve nedensellik ilişkisinin yokluğunu gösteren sıfır hipotezi aşağıdaki gibi gösterilmiştir;

$$H_0: a_{2,1} = a_{2,2} = \dots = a_{2,k} = 0 \quad (LNCOV, LNENDEKS'in Granger nedeni değildir)$$

5.1. Birim kök testine ilişkin bulgular

Serilerin birim kök içerip içermediği literatürde sıklıkla kullanılan yöntemlerden birisi olan Augmented Dickey-Fuller (ADF) testi kullanılarak tespit edilmiş ve Tablo 2'den de görüleceği üzere bazı değişkenlerin I(0) ve bazılarının da I(1)'de durağan bulunması nedeniyle Toda Yamamoto yöntemiyle nedensellik analizi gerçekleştirilmesine karar verilmiştir. Serilerin maksimum bütünlük seviyelerinin belirlenmesinde sabitli-trendli model sonuçları baz alınmıştır.

Tablo 2. ADF Birim Kök Testi Sonuçları

Değişkenler	Düzye Değerleri I(0)		Değişkenler	Birinci Farkları I(1)	
	Sabit	Sabit+Trend		Sabit	Sabit+Trend
LNCOV	-3.501583***	-5.048226***	LNCOV	-22.94233***	-23.01915***
LNXBANK	-0.687815	-2.140531	LNXBANK	-24.42186***	-24.44755***
LNXBLSM	-3.404102**	-4.040654***	LNXBLSM	-12.55904***	-12.76766***
LNXLKT	-1.363263	-1.868372	LNXLKT	-24.52379***	-24.53505***
LNXFINK	-3.806482***	-2.970983	LNXFINK	-12.73667***	-12.85778***
LNKGIDA	-1.957660	-2.658572	LNKGIDA	-14.19322***	-14.19597***
LNKGMYO			LNKGMYO		
LNKHOLD			LNKHOLD		



LNXILTM	-0.949125	-1.675973	LNXHOLD	-25.30657***	-25.29108***
LNXINSA	-0.708102	-2.056401	LNXILTM	-14.53568***	-14.52430***
LNXXKAGT	-1.734007	-2.585289	LNXINSA	-25.32782***	-25.30459***
LNXXKMYA	-1.272487	-3.174503*	LNXXKAGT	-26.68155***	-26.66950***
LNXMADN	-3.011452**	-2.506707	LNXXKMYA	-22.33374***	-22.42729***
LNXMANA	-0.287368	-2.013459	LNXMADN	-23.08934***	-23.06619***
LNXMESY	-0.770572	-2.086961	LNXMANA	-23.36592***	-23.34359***
LNXXSGR	-0.815207	-2.614449	LNXMESY	-15.17884***	-15.16633***
LNXXSPOR	-1.745805	-1.968492	LNXXSGR	-13.75631***	-13.79756***
LNXTAST	-2.083451	-1.448356	LNXXSPOR	-14.65442***	-22.25609***
LNXTCRT	-3.043283**	-3.127187	LNXTAST	-20.75684***	-20.81759***
LNXTTEKS	-2.343653	-1.922618	LNXTCRT	-23.98547***	-24.10808***
LNXTZM	-2.816628*	-3.128095	LNXTTEKS	-8.293492***	-8.306941***
LNXTULAS	-1.638372	-1.749369	LNXTZM	-24.77105***	-24.83429***
	-2.966439**	-2.189750	LNXTULAS	-21.03693***	-21.21292***
	0.565642	-1.888492		-23.10240***	-23.11122***

Not: *: %10, ******: %5 ve *******: %1 seviyesinde anlamlılığı ifade etmektedir. Optimum gecikme uzunlukları Akaike Bilgi Kriterine (AIC) göre otomatik olarak belirlenmiştir.

5.2. Nedensellik analizine ilişkin bulgular

Toda Yamamoto nedensellik analizinde öncelikle her alt sektör endeksi için VAR modeli oluşturularak uygun gecikme uzunlukları VAR(p) belirlenmiş ve serilerin maksimum bütünleşme derecesi (d) ile toplanarak VAR(p+d) modeli çerçevesinde analizler gerçekleştirilmiştir. Daha sonra elde edilen ki-kare değerleri için olasılık değerleri uygun gecikme uzunluğuna göre yeniden hesaplanarak Tablo 3'te sonuçlar gösterilmiştir.

Tablo 3. Toda-Yamamoto nedensellik analizi sonuçları

Sıfır Hipotezi	Ki- Kare	k	D _{max}	Olasılık	Karar
LNCOV \Rightarrow LNXBANK	1.352358	1	I(I)	0,2448	H ₀ kabul
LNCOV \Rightarrow LNXBLSM	6.975610	5	I(0)	0,2225	H ₀ kabul
LNCOV \Rightarrow LNXELKT	4.062295	1	I(I)	0,0438	H ₀ red
LNCOV \Rightarrow LNXFINK	0.304715	1	I(I)	0,5809	H ₀ kabul
LNCOV \Rightarrow LNXGIDA	2.214104	1	I(I)	0,1367	H ₀ kabul
LNCOV \Rightarrow LNXGMYO	3.843803	1	I(I)	0,0499	H ₀ red
LNCOV \Rightarrow LNXHOLD	3.573276	1	I(I)	0,0587	H ₀ kabul
LNCOV \Rightarrow LNXILTM	0.129893	1	I(I)	0,7185	H ₀ kabul
LNCOV \Rightarrow LNXINSA	4.893515	2	I(I)	0,0865	H ₀ kabul
LNCOV \Rightarrow LNXXKAGT	2.575308	1	I(I)	0,1085	H ₀ kabul
LNCOV \Rightarrow LNXXKMYA	5.886595	1	I(I)	0,0152	H ₀ red
LNCOV \Rightarrow LNXMADN	6.872912	1	I(I)	0,0087	H ₀ red
LNCOV \Rightarrow LNXMANA	4.390330	1	I(I)	0,0361	H ₀ red
LNCOV \Rightarrow LNXMESY	7.640827	5	I(I)	0,1771	H ₀ kabul
LNCOV \Rightarrow LNXXSGR	4.928841	1	I(I)	0,0264	H ₀ red
LNCOV \Rightarrow LNXXSPOR	3.289327	2	I(I)	0,1930	H ₀ kabul
LNCOV \Rightarrow LNXTAST	4.090255	1	I(I)	0,0431	H ₀ red
LNCOV \Rightarrow LNXTCRT	4.741445	1	I(I)	0,0294	H ₀ red
LNCOV \Rightarrow LNXTTEKS	3.797590	1	I(I)	0,0513	H ₀ kabul
LNCOV \Rightarrow LNXTZM	10.47811	2	I(I)	0,0053	H ₀ red
LNCOV \Rightarrow LNXULAS	2.674605	1	I(I)	0,1019	H ₀ kabul



Not: k, iki deęişkenli VAR modeli için optimum gecikme uzunluęunu, D_{max} , ise maksimum bütünleşme seviyelerini göstermektedir.

Tablo 3'ten de görüleceęi üzere Kovid-19 kısıtlamaları, Borsa İstanbul alt sektör endekslerinden Elektrik (XELKT), Gayri Menkul Yatırım Ortaklığı (XGMYO), Kimyasal Petrol ve Plastik (XKMYA), Maden (XMADN), Metal Ana (XMANA), Sigorta (XSGRT), Taş Toprak (XTAST), Toptan Satış ve Perakende (XTCRT) ve Turizm (XTRZM) endekslerinin Granger nedeni olarak bulunmuştur. Dolayısıyla Kovid-19 kısıtlamalarında gerçekleşen bir deęişim ilgili alt sektör endekslerinde de bir deęişme neden olmaktadır. Bu sonuçlar sosyal mesafe uygulamalarıyla BİST100 endeksinin ilişkili olduğunu ortaya koyan Çetin (2020)'in sonuçlarıyla benzerlik göstermekte ve Çetin (2020)'den farklı olarak sonuçları Borsa İstanbul alt sektörler bazında özelleştirmektedir.

5.3. Etki-Tepki analizine ilişkin bulgular

Son olarak Kovid-19 kısıtlamalarıyla nedensellik ilişkileri tespit edilen Borsa İstanbul alt sektör endekslerine ilişkin etki-tepki analizi gerçekleştirilerek Kovid-19 kısıtlamalarındaki bir standart sapmalık şoka karşın alt sektör endekslerinin verdiği tepkiler ortaya konulmaya çalışılmıştır.

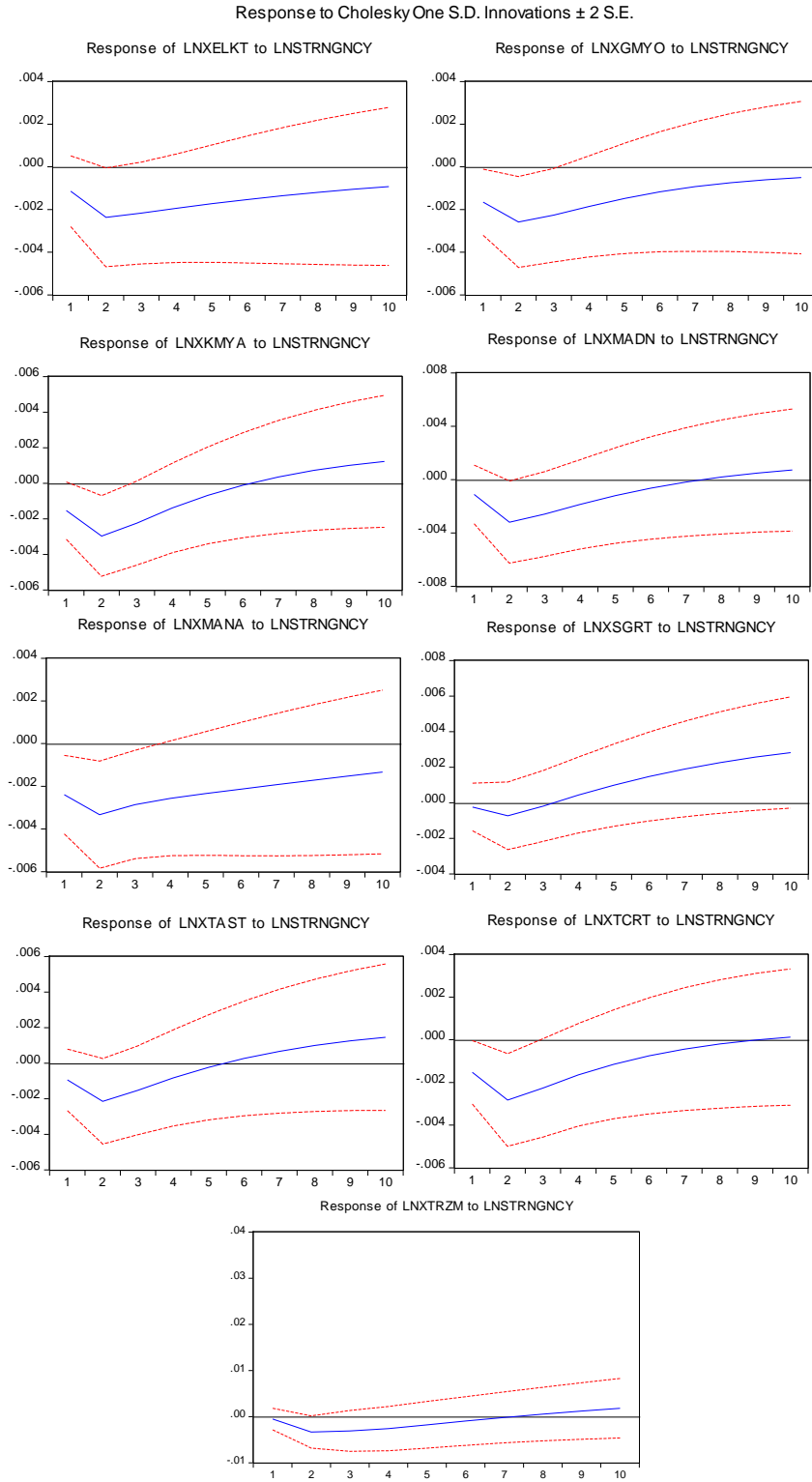

Grafik 2. Etki-tepki analizi fonksiyonları

VAR modeli sonucu elde edilen etki-tepki fonksiyonlarına göre Kovid-19 kısıtlamalarıyla nedensellik ilişkisi tespit edilen Grafik 2'deki tüm endekslerin, Kovid-19'daki bir standart sapmalı şok karşısında negatif tepkiler verdikleri ve iki dönem boyunca bu negatif tepkilerin artarak devam ettiği görülmektedir. İkinci dönemden sonra ise tepkiler giderek azalmaktadır. LNXXKMYA'da altıncı döneme kadar, LNXXMADN ve LNXXTRZM'de yedinci döneme kadar, LNXXSGRT'de üçüncü döneme kadar, LNXXTAST'da beşinci döneme ve LNXXTCRT'de dokuzuncu döneme kadar negatif



tepkiler azalan bir şekilde devam etmiştir ve sıfır noktasını keserek pozitif dönmüşlerdir. LNXELKT, LNXGMYO ve LNXMANA endeksleri 10 dönemlik bir süreçte giderek sıfır noktasına yaklaşmakta ancak sıfır noktasını kesmemektedirler. Sonuçlar genel olarak değerlendirildiğinde Kovid-19 kısıtlamalarındaki bir standart sapmalılık şokun endeksleri iki gün boyunca artan bir şekilde negatif etkilediği, ikinci dönemden sonra negatif etkilerin azalan bir şekilde devam ettiğini ve ortalama yedinci dönemde bu negatif etkilerin ortadan kaybolduğunu söylemek mümkündür.

6. Sonuç

Bu çalışmada Türkiye Cumhuriyeti Devleti'nin Kovid-19 tedbirleri kapsamında uygulamış olduğu Devlet müdahalelerinin sıklığı ile Borsa İstanbul alt sektör endeksleri arasındaki nedensellik ilişkileri ortaya konulmaya çalışılmış ve Toda-Yamamoto nedensellik analizine göre Devlet müdahalelerinin, incelenen 21 alt sektör endeksinin dokuzunun nedeni olduğu sonucuna ulaşılmıştır. Bu sektörler Elektrik, Gayri Menkul Yatırım Ortaklığı, Kimyasal Petrol ve Plastik, Maden, Metal Ana, Sigorta, Taş Toprak, Toptan Satış ve Perakende ve Turizm sektörleridir. Diğer taraftan kısa süreli ilişkilerin incelendiği bu çalışmada Kovid-19 pandemisinin uzun bir geçmişe sahip olmaması ve Devlet Müdahalelerine ilişkin verilerin 11 Mart 2020 tarihinden itibaren erişilebilir olması nedeni ile 546 günlük veri ile çalışmış ve bu nedenle uzun dönemli bir ilişkinin varlığının araştırılması uygun görülmemiştir. Devlet müdahalelerine karşı endekslerin verdiği tepkiyi görmek açısından etki-tepki fonksiyonlarına bakılmış ve ilgili dokuz alt sektör endeksinin tamamının Devlet Müdahalelerine karşı negatif bir tepki verdiği görülmüştür.

Sonuçlar genel olarak değerlendirildiğinde iş yerlerinin, alış-veriş merkezlerinin, restoranların ve eğitim kurumlarının kapatılması nedeniyle elektrik talebinde azalmaların meydana geldiği ve bunlara ek olarak sokağa çıkma kısıtlamaları ile zincir marketlerin çalışma saatlerine getirilen kısıtlamaların da Toptan Satış ve Perakende sektörünü olumsuz etkilediği düşünülmektedir. GMYO'ların portföylerindeki alış-veriş mağazalarının kiracılarının bir kısmı faaliyetlerini durdurmuş ve otellerin doluluk oranları azalmıştır. Diğer taraftan tırların gümrük kapılarında, gemilerin uzun süre limanlarda bekletilmesi, hava sahalarının kapatılması ve fabrikaların faaliyetlerine ara vermesi gibi virüs kaynaklı tedbirler neticesinde hammadde ithal eden firmalarda tedarik sorunları yaşanırken ihracatta da azalmalar meydana gelmiştir. İhracatının büyük kısmının Çin'e gerçekleştirildiği Maden sektörü ile birlikte Metal Ana ve Petrol ve Plastik sektörü de kısıtlamalardan olumsuz olarak etkilenmiştir. Kovid-19'un sigorta sektörünü nasıl etkileyebileceği düşünüldüğünde araçların trafiğe çıkmaması, seyahat kısıtlamaları nedeniyle seyahat sigortalarının gerçekleştirilememesi gibi faktörler dolayısıyla sigorta taleplerinde de daralmaların meydana geldiği düşünülmektedir. Bunlara ek olarak döviz kurundaki artışlar nedeniyle yedek parça maliyetlerindeki artışların sigorta şirketlerine ek bir yükümlülük getirdiğinden de bahsedilebilmektedir. Benzer şekilde fabrikaların kapatılması ve birçok sektörde uzaktan çalışma modeline geçilmesine karşın inşaat sektöründe böyle bir imkânın bulunmaması çimento üretiminde düşüşlerin yaşanmasına, girdi maliyetlerin artmasına, şantiyelerde işlerin durma noktasına gelmesine sebebiyet vermiştir. Hiç kuşkusuz ki Kovid-19 kısıtlamalarından en çok etkilenen sektörlerden biri de Turizm sektörüdür. Ülkeye giriş-çıkışların sınırlandırılması, otellerin faaliyetlerine ara vermesi, seyahat kısıtlamaları vb. sınırlamalar neticesinde Turizm cenneti olarak nitelendirilen Türkiye'de sektör büyük kayıplar yaşamıştır.

Bu çalışmanın sonuçları yatırımcılar ve şirket yöneticileri için önemli çıkarımlara sahiptir. Yukarıdaki açıklamalardan yola çıkılarak hükümetlerin ileride herhangi bir nedenden ötürü benzer Devlet Müdahaleleri gerçekleştirmesi durumunda, yatırımcıların ilgili dokuz sektör endeksine karşı tedbirli davranmaları ve şirket yöneticilerinin benzer küresel kısıtlamalara karşın iş yapış şekillerini hızla dijital dönüşüme uyarlamaları tavsiye edilmektedir. Bu çalışmada Türkiye'deki kısıtlamaların



alt sektör endeksleri üzerindeki etkilerine odaklanılmıştır. Bundan sonra yapılacak olan çalışmalarda Borsa İstanbul alt sektör endekslerinin Türkiye'nin en çok ihracat ve ithalat gerçekleştirdiği ülkelerdeki kısıtlamalardan nasıl etkilendiği ve yine Türkiye'deki kısıtlamaların ilgili ülkelerin sektörlerini nasıl etkilediği araştırılabilir.

Kaynakça

Aggarwal, S., Nawn, S. ve Dugar, A. (2021). What caused global stock market meltdown during the COVID pandemic–Lockdown stringency or investor panic?, *Finance Research Letters*, 38, 1-6. Doi: [10.1016/j.frl.2020.101827](https://doi.org/10.1016/j.frl.2020.101827)

Anadolu Ajansı (2021, 10 Mart). Türkiye'nin 1 yıllık Kovid-19'la mücadele sürecinin 'tedbir karnesi'. 02.06.2022 tarihinde <https://www.aa.com.tr/tr/koronavirus/turkiyenin-1-yillik-kovid-19la-mucadele-surecinin-tedbir-karnesi/2171001> adresinden alındı.

Atıcı-Ustalar, S. ve Şanlısoy, S. (2020). COVID-19 küresel salgınının BİST100 getirisi üzerine etkisinin analizi, N. Şimşek ve diğerleri (Ed.), 4th International Congress On Economics Finance and Energy “Political Economy of Energy Revolution” (s. 632-644) içinde. Ankara: Ahmet Yesevi Üniversitesi. Erişim Adresi: <http://hdl.handle.net/20.500.12397/13926>

Bakry, W., Kavalnthara, P. J., Saverimuttu, V., Liu, Y. ve Cyril, S. (2022). Response of stock market volatility to COVID-19 announcements and stringency measures: A comparison of developed and emerging markets, *Finance Research Letters*, 46, Part A, 1-10. Doi: [10.1016/j.frl.2021.102350](https://doi.org/10.1016/j.frl.2021.102350)

Barut, A. ve Yerdelen-Kaygın, C. (2020). Covid-19 pandemisinin seçilmiş borsa endeksleri üzerine etkisinin incelenmesi, *Gaziantep University Journal of Social Sciences*, 19 (COVID-19 Özel Sayısı), 59-70. Doi: [10.21547/jss.773237](https://doi.org/10.21547/jss.773237)

Borsa İstanbul A.Ş. (2022a). BIST Endeks Kodları ve Başlangıç Değerleri. 01.10.2022 tarihinde <https://borsaistanbul.com/files/bist-endeks-kodlari-ve-baslangic-degerleri.xlsx> adresinden alındı.

Borsa İstanbul A.Ş. (2022b). BIST Pay Endeksleri. 01.10.2022 tarihinde <https://www.borsaistanbul.com/tr/sayfa/44/bist-pay-endeksleri> adresinden alındı.

Borsa İstanbul A.Ş. (2022c). Endeksler. 01.10.2022 tarihinde <https://www.borsaistanbul.com/tr/sayfa/1132/endeksler> adresinden alındı.

Borsa İstanbul A.Ş. (2022d). Veri Yayın Ürünleri. 01.10.2022 tarihinde <https://borsaistanbul.com/tr/sayfa/189/veri-yayin-urunleri> adresinden alındı.

Borsa İstanbul A.Ş. (2020). BISTECH CONNECT Kullanıcı Oluşturma Taahhütnamesi. 01.10.2022 tarihinde from <https://www.borsaistanbul.com/tr/sayfa/580/connectverda> adresinden alındı.

Borsa İstanbul Endeks Direktörlüğü. (2022a). BIST Piyasa Değeri Ağırlıklı Olmayan Pay Endeksleri Temel Kuralları. 01.10.2022 tarihinde <https://www.borsaistanbul.com/tr/sayfa/44/bist-pay-endeksleri> adresinden alındı.

Borsa İstanbul Endeks Direktörlüğü. (2022b). BIST Piyasa Değeri Ağırlıklı Pay Endeksleri Temel Kuralları. 01.10.2022 tarihinde <https://www.borsaistanbul.com/tr/sayfa/44/bist-pay-endeksleri> adresinden alındı.

Borsa İstanbul Endeks ve Veri Direktörlüğü. (2018). BIST Pay Endeksleri Temel Kuralları BIST.

Çetin, A. C. (2020). Koronavirüs (Covid-19) salgınının Türkiye'de genel ekonomik faaliyetlere ve hisse senedi borsa endeksine etkisi, *Mehmet Akif Ersoy Üniversitesi Uygulamalı Bilimler Dergisi*, 4(2), 341-362. Doi: [10.31200/makuubd.766901](https://doi.org/10.31200/makuubd.766901)



- Çil-Yavuz, N. (2011). Durağanlığın belirlenmesinde KPSS ve ADF testleri: İMKB Ulusal-100 endeksi ile bir uygulama. *İstanbul Üniversitesi İktisat Fakültesi Mecmuası*, 54 (1), 239- 247. 20.05.2022 tarihinde <https://dergipark.org.tr/tr/pub/iuifm/issue/810/8792> adresinden alındı.
- Deutsch Welle (2021, 10 Mart). Türkiye'de pandemi: Bir yılda neler yaşandı? 02.06.2022 tarihinde <https://www.dw.com/tr/t%C3%BCrkiyede-pandemi-bir-y%C4%B1lda-neler-ya%C5%9Fand%C4%B1/a-56822009> adresinden alındı.
- Ertuğrul-Ayrancı, A. ve Arı, G. (2021). Covid-19 pandemisinin BIST sektör endeksleri ile ilişkisi: Bayer – Hanck (2013) eşbütünleşme analizi, *İşletme Araştırmaları Dergisi*, 13 (4), 3770-3785. Doi: [10.20491/isarder.2021.1355](https://doi.org/10.20491/isarder.2021.1355)
- Gazel, S. (2017). BİST Sınai endeksi ile çeşitli metaller arasındaki ilişki: Toda-Yamamoto nedensellik testi, *Akademik Sosyal Araştırmalar Dergisi*, 52, 287-299. Doi: [10.16992/ASOS.12637](https://doi.org/10.16992/ASOS.12637)
- Gümü, A. ve Hacıevliyagil, N. (2020). COVID-19 salgın hastalığının borsaya etkisi: turizm ve ulaştırma endeksleri üzerine bir uygulama, *Akademik Yaklaşımlar Dergisi*, 11(1), 76-98. 21.05.2022 tarihinde <https://dergipark.org.tr/tr/pub/ayd/issue/56831/772209> adresinden alındı.
- Korkut, Y., Eker, M., Zeren, F. ve Altunışık, R. (2020). Covid-19 pandemisinin turizm üzerindeki etkileri: Borsa İstanbul turizm endeksi üzerine bir inceleme, *Gaziantep University Journal of Social Sciences*, 19, COVID-19 Özel Sayısı, 71-86. Doi: [10.21547/jss.774557](https://doi.org/10.21547/jss.774557)
- Meçik, O. ve Koyuncu, T. (2020). Türkiye’de göç ve ekonomik büyüme ilişkisi: TodaYamamoto nedensellik testi, *İnsan ve Toplum Bilimleri Araştırmaları Dergisi*, 9(3), 2618-2635. Doi: [10.15869/itobiad.748770](https://doi.org/10.15869/itobiad.748770)
- Nicola, M., Alsafi, Z., Sohrabi, C., Kerwan, A., Al-Jabir, A., Iosifidis, C., Agha, M. ve Agha, R. (2020). The socio-economic implications of the coronavirus pandemic (COVID-19): A review, *International Journal of Surgery*, 78, 185–193. Doi: [10.1016/j.ijssu.2020.04.018](https://doi.org/10.1016/j.ijssu.2020.04.018)
- Our World in Data. (2022). COVID-19 Data Explorer: Covid-19 Stringency Index. 01.10.2022 tarihinde <https://ourworldindata.org> adresinden alındı.
- Özdemir, L. (2020). Covid-19 pandemisinin BİST sektör endeksleri üzerine asimetrik etkisi. *Finans Ekonomi ve Sosyal Araştırmalar Dergisi*, 5 (3) , 546-556. Doi: [10.29106/fesa.797658](https://doi.org/10.29106/fesa.797658)
- Phillips, T. (2022). The Oxford Coronavirus Government Response Tracker (OxCGRT) - Methodology for calculating indices. 01.10.2022 tarihinde https://github.com/OxCGRT/covid-policy-tracker/blob/master/documentation/index_methodology.md adresinden alındı.
- Roser, M. (2021). What is the COVID-19 Stringency Index? 01.10.2022 tarihinde <https://ourworldindata.org/metrics-explained-covid19-stringency-index> adresinden alındı.
- Rossi, B. ve Wang, Y. (2019). VAR-based Granger-Causality test in the presence of instabilities, *Barcelona GSE Working Paper Series 1083*, Barcelona Graduate School of Economics. 21.05.2022 tarihinde <https://ideas.repec.org/p/bge/wpaper/1083.html> adresinden alındı.
- Scherf, M., Matschke, X. ve Rieger, M. O. (2022). Stock market reactions to COVID-19 lockdown: A global analysis, *Finance Research Letters*, 45, 1-6. Doi: [10.1016/j.frl.2021.102245](https://doi.org/10.1016/j.frl.2021.102245)
- Şenol, Z. ve Otçeken, G. (2021). COVID-19’un BİST sektörlerine etkisi, *Finans Ekonomi ve Sosyal Araştırmalar Dergisi*, 6 (3), 509-518. Doi: [10.29106/fesa.984219](https://doi.org/10.29106/fesa.984219)
- T.C. İçişleri Bakanlığı (2021a, 14 Nisan). 81 İl Valiliğine kısmi kapanma genelgesi gönderildi. 02.06.2022 tarihinde <https://www.icisleri.gov.tr/81-il-valiligine-kismi-kapanma-genelgesi-gonderildi> adresinden alındı.
- T.C. İçişleri Bakanlığı (2021b, 26 Nisan). 81 İl Valiliğine tam kapanma tedbirleri genelgesi gönderildi. 02.06.2022 tarihinde <https://www.icisleri.gov.tr/81-il-valiligine-tam-kapanma-tedbirleri-genelgesi-gonderildi> adresinden alındı.



- T.C. İçişleri Bakanlığı (2021c, 16 Mayıs). Kademeli normalleşme tedbirleri genelgesi. 02.06.2022 tarihinde <https://www.icisleri.gov.tr/kademeli-normallesme-tedbirleri-genelgesi> adresinden alındı.
- T.C. İçişleri Bakanlığı (2021d, 1 Haziran). Haziran ayı normalleşme tedbirleri genelgesi. 02.06.2022 tarihinde <https://www.icisleri.gov.tr/haziran-ayi-normallesme-tedbirleri-genelgesi> adresinden alındı.
- T.C. İçişleri Bakanlığı (2021e, 27 Haziran). 81 İl Valiliğine kademeli normalleşme tedbirleri genelgesi gönderildi. 02.06.2022 tarihinde <https://www.icisleri.gov.tr/81-il-valiligine-kademeli-normallesme-tedbirleri-genelgesi-gonderildi> adresinden alındı.
- T.C. Sağlık Bakanlığı (2021, 11 Mart). Bakan Koca, Türkiye'nin Kovid-19'la 1 yıllık mücadele sürecini değerlendirdi. 02.06.2022 tarihinde <https://www.saglik.gov.tr/TR,80604/bakan-koca-turkiyenin-kovid-19la-1-yillik-mucadele-surecini-degerlendirdi.html> adresinden alındı.
- Tayar, T., Gümüştekin, E., Dayan, K. ve Mandi, E. (2020). Covid-19 krizinin Türkiye'deki sektörler üzerinde etkileri: Borsa İstanbul sektör endeksleri araştırması, *Van Yüzyüncü Yıl Üniversitesi Sosyal Bilimler Enstitüsü Dergisi*, Salgın hastalıklar özel sayısı, 293-320. 21.05.2022 tarihinde <https://dergipark.org.tr/tr/pub/yyusbed/issue/56115/772087> adresinden alındı.
- TRT Haber (2021, 7 Eylül). 81 ile "PCR testi zorunluluğu" genelgesi. 02.06.2022 tarihinde <https://www.trthaber.com/haber/gundem/81-ile-pcr-testi-zorunlulugu-genelgesi-603213.html> adresinden alındı.
- TRT Haber (2020, 18 Mart). Türkiye'de koronavirüs kaynaklı ilk ölüm. 02.06.2022 tarihinde <https://www.trthaber.com/haber/gundem/turkiyede-koronavirus-kaynakli-ilk-olum-467942.html> adresinden alındı.
- TRT Haber (2022a, 31 Mayıs). Sınırlarda PCR testi zorunluluğu kaldırıldı. 02.06.2022 tarihinde <https://www.trthaber.com/haber/gundem/sinirlarda-pcr-testi-zorunlulugu-kaldirildi-684615.html> adresinden alındı.
- TRT Haber (2022b, 29 Mayıs). Toplu taşımada maske zorunluluğu kaldırıldı. 02.06.2022 tarihinde <https://www.trthaber.com/foto-galeri/toplu-tasimada-maske-zorunlulugu-kaldirildi/47195.html> adresinden alındı.
- Yang, H., ve Deng, P. (2021). The impact of COVID-19 and government intervention on stock markets of OECD countries. *Asian Economics Letters*, 1(4). 1-6. Doi: [10.46557/001c.18646](https://doi.org/10.46557/001c.18646)
- Yıldız Contuk, F. (2021). Covid -19'un Borsa İstanbul üzerindeki etkisi: Bir ARDL sınır testi modeli. *Muhasebe ve Finansman Dergisi*, (89) , 101-112. Doi: [10.25095/mufad.852088](https://doi.org/10.25095/mufad.852088)
- Zaremba, A., Kizys, R., Aharon, D. Y. ve Demir, E. (2020). Infected Markets: Novel Coronavirus, Government Interventions, and Stock Return Volatility around the Globe, *Finance Research Letters*, 35, 1-7. Doi: [10.1016/j.frl.2020.101597](https://doi.org/10.1016/j.frl.2020.101597)



MÜASİR İPƏK YOLU LAYİHƏSİ VƏ AZƏRBAYCANIN İŞTİRAKI

Tovuz Daşdəmirova

Bakı Dövlət Universiteti, Beynəlxalq münasibətlər və iqtisadiyyat fakültəsi, Bakı, Azərbaycan

Xülasə

Məqalədə Çin tərəfindən irəli sürülən “Bir kəmər, bir yol” layihəsi haqqında danışılır. Tədqiqatın məqsədi “Müasir İpək yolu” kimi qiymətləndirilən layihənin Azərbaycan üçün hansı üstünlüklərə malik olduğunu göstərməkdir. Tədqiqat zamanı məntiqi ümumiləşdirmə, elmi abstraksiya kimi metodlardan istifadə edilmişdir. Azərbaycanın “Bir kəmər, bir yol” layihəsində iştirakı zamanı qarşıya qoyduğu məqsədlərin birbaşa olaraq BMT-nin “2030-cu ilədək dayanıqlı inkişaf sahəsində Gündəlik”də əks olunan Dayanıqlı İnkişaf Məqsədləri ilə əlaqəsi var. Tədqiqat nəticəsində belə qənaətə gəlinmişdir ki, layihədə iştirak Azərbaycana qarşıya qoyduğu məqsədlərə çatmağa və tranzit potensialından maksimum şəkildə yararlanmağa kömək edəcək.

Açar sözlər: Bir kəmər, bir yol, İpək yolu İqtisadi kəməri, Dəniz İpək yolu, əsas prioritetlər.

MODERN SILK ROAD PROJECT AND PARTICIPATION OF AZERBAIJAN

Abstract

The article talks about the "One Belt, One Road" project put forward by China. The purpose of the study is to show what advantages the project, which is considered as "Modern Silk Road", has for Azerbaijan. Methods such as logical generalization and scientific abstraction were used during the research. The goals set by Azerbaijan during its participation in the "One Belt, One Road" project are directly related to the Sustainable Development Goals reflected in the UN's "Sustainable Development Agenda until 2030". As a result of the study, it was concluded that participation in the project will help Azerbaijan to achieve its goals and make the most of its transit potential.

Keywords: One belt, one road, Silk Road Economic Belt, Maritime silk road, main priorities.

GİRİŞ

Qədim İpək yolu yüzilliklər boyu Şərqi Qərblə birləşdirən böyük əhəmiyyətə malik körpü olmuşdur. Bu yol Şimalı Cənubla, Qərbi Şərqlə təkcə ticari-iqtisadi deyil, eyni zamanda siyasi-diplomatik, mədəni-humanitar əlaqələrlə də bir-birinə bağlayırdı. Mənəvi baxışların mübadiləsinə və milli sivilizasiyaların zənginləşməsinə təkan vermişdir. Lakin Amerikanın quru sahəsi kimi kəşfindən və Hindistana dəniz yolunun tapılmasından sonra Böyük İpək yolu öz əhəmiyyətini itirməyə başlamışdır. Bu proses XX əsrin son onilliyinə kimi davam etmişdir. Bu zamandan sonra isə Böyük İpək yolu və onun üstünlükləri anlayışı gündəmə daha çox gəlməyə başlanmışdır. Başqa sözlə, qədim zamanlardan mövcud olan Böyük İpək yolunun bərpa və inkişafı prosesinə başlanmışdır. Dünya ölkələrinin siyasi, iqtisadi quruluşunda baş verən dəyişikliklərdən sonra bu yolun əhəmiyyəti yüksək qiymətləndirilirdi. Avropa İttifaqının TACIS proqramı çərçivəsində TRASEKA (Avropa-Qafqaz-Asiya Nəqliyyat Dəhlizi) layihəsi Böyük İpək yolunun yenidənqurulması və inkişafında mühüm rol oynamışdır. 2013-cü ildə isə Çin Xalq Respublikası “Bir kəmər, bir yol” adlı yeni inkişaf strategiyası qəbul etdiyini elan etmişdir. Bununla da Müasir İpək yolu layihəsinin əsası qoyulmuşdur.



Azərbaycan Respublikası Böyük İpək yolunun bərpa və inkişafına böyük əhəmiyyət verdiyini göstərərək bu prosesdə yaxından iştirak etmişdir.

Müasir İpək Yolu layihəsi və Azərbaycanın iştirakı

Son illərdə Çin qlobal səhnədə öz nüfuzunu artırmaq, özünün daha böyük əhəmiyyət kəsb etdiyini təbliğ etmək üçün mühüm işlər həyata keçirir. Çin şirkətləri öz daxili bazarlarını tərk edərək yeni texnologiyalar və təzə bazarlar əldə etmək üçün xarici bazarlara yönəlirlər. Hazırda Çin dünyanın ən böyük 2-ci iqtisadiyyatına sahibdir. Həyata keçirilən islahatlar və açıq siyasət nəticəsində Çin beynəlxalq ticarətdə nüfuz sahibi olmağa başladı. 2001-ci ildə Çin Ümumdünya Ticarət Təşkilatına üzv olaraq son 30 ildə dünyanın ən böyük istehsalçılarından biri olmuşdur.

Çin Kommunist Partiyasının baş katibi və Çin Xalq Respublikasının sədri Si Cinpinin rəhbərliyi altında Çin 2013-cü ildə **“Bir kəmər, bir yol” (One Belt, One Road - OBOR)** adlı yeni inkişaf strategiyası qəbul etdiyini elan etmişdir. Bununla da, Müasir İpək yolunun əsası qoyulmuşdur desək yanlışdır. “Bir kəmər, bir yol” təşəbbüsü 2018-ci ildə Çin Konstitusiyasına daxil edilmişdir. Si Cinpin Administrasiyası bu təşəbbüsü “regional əlaqəni gücləndirmək və daha parlaq gələcəyə doğru təklifi” adlandırır. Layihənin Çin Xalq Respublikasının yaranmasının 100 illiyinə, yəni 2049-a qədər tamamlamağı qarşıya qoyduğu məqsədləri vardır. Milli səviyyədə Çinin qarşısına qoyduğu məqsədlər yenidən bərpa olunma, sosial, iqtisadi, siyasi və mədəni sahələrdə yüksək inkişaf etmiş müasir cəmiyyət quruculuğuna nail olmaq idi. Bir sözlə, 2013-cü ildən qarşıya qoyulan “Çin rəyası” məqsədinə çatmaqdır. “Çin rəyası” Çin siyasətində məşhur olan termdir və Çin Kommunist Partiyasının Çin dəyərlərinə və sosializm məqsədlərinə uyğun baxışlarını əks etdirir. Bu termini daha çox rəsmi dövlət məmurları, jurnalistlər, müxtəlif fəallar kimi cəmiyyətin müxtəlif təbəqələrindən olan insanlar işlədir və “Çin millətinin məqsədlərini” ifadə edir.

“Bir kəmər, bir yol” strategiyası Avrasiya ölkələrinin arasında qarşılıqlı əlaqələrin qurulması və infrastrukturun yaradılmasına yönəldilmişdir. Bu strategiya 2 əsas istiqaməti: **“İpək Yolu İqtisadi Kəməri” və “Dəniz İpək Yolu”**nu nəzərdə tutur. Əsas məqsəd Şərqi və Qərbi arasında malların güzəştli şərtlərlə daşınması üçün ticarət dəhlizinin yaradılmasıdır. “Bir kəmər, bir yol” layihəsi regional inteqrasiyanın yeni mərhələsi olaraq Cənub-şərqi Asiya, Cənubi Asiya, Orta Asiya və Qərbi Asiyaları bir-biri ilə əlaqələndirəcək. Bununla da bütünlükdə Asiyanın sənaye, təchizat, dəyər zəncirlərinin yaradılmasına nail olunacaq. “Bir kəmər, bir yol” layihəsi bütünlükdə regionda mühüm əhəmiyyətə malik layihələrdəndir. Əsas mahiyyət ondan ibarətdir ki, Çin-Avropa marşrutu üzrə yola çıxan yüklər, sürücülər ən qısa zamanda mənzil başına çata bilsinlər.

65 ölkənin iştirak etdiyi “Bir kəmər, bir yol” layihəsi dünya əhalisinin 60%-ni, təxminən 4,4 milyard insanı, eyni zamanda 40-a yaxın güclü iqtisadiyyatı olan ölkəni əhatə edir. Nəzərdə tutulan əsas məsələ ixrac sahəsində yeni bazarlar yaradaraq, məhsul müxtəlifliyinə nail olaraq qlobal ticarəti yenidən formalaşdırmaqdır. Layihənin həyata keçirəcəyi mühüm məsələ dəniz və hava limanları, dəmir və quru yolları, neft və qaz kəmərləri kimi iri infrastruktur layihələr inşa edərək qitələr arasında inteqrasiyaya nail olmaqdır. İnteqrasiyaya nail olunmaqla eyni zamanda ölkələr arasında yükdaşınması zamanı sərf olunan zaman qısalararaq yol xərclərinin azalmasına səbəb olacaq [7].

“Bir kəmər, bir yol” layihəsində **“Kəmər” anlayışı** layihədəki avtomobil yolları, dəmir yolları, neft və təbii qaz boru kəmərlərini ifadə etmək üçün istifadə edilmişdir. Çindən Orta Asiyaya, Moskva və Venesiyaya uzanan nəqliyyat şəbəkəsi nəzərdə tutulur. Layihədə Asiya-Avropa istiqamətində dəhlizlər var. Bu planlaşdırılmış marşrutlar: Çin-Monqolustan-Rusiya, Çin-Banqladeş-Hindistan-Myanma, Çin-Mərkəzi və Qərbi Asiya, Çin-Hind-Çin yarımadası, Çin-Pakistandır. **“Yol” anlayışı** layihədə dəniz marşrutu şəbəkəsini ifadə etmək üçün istifadə olunur. Dəniz yolu Cənubi və Cənub-Şərqi Asiyadan Şərqi Afrikaya və Aralıq dənizinin şimalına qədər uzanan nəqliyyat şəbəkəsini əhatə edir.

OBOR layihəsinin bir hissəsini təşkil edən **“İpək Yolu İqtisadi Kəməri”** Çinin Avropa və Asiya ölkələri ilə ticarət və nəqliyyat əlaqələrini rəsmiləşdirmək üçün həyata keçiriləcək ən böyük layihədir. Asiya və Avropanın mərkəzi ərazilərini birləşdirən İpək Yolu İqtisadi Kəməri min



kilometrdən çox uzunluğa malikdir və dünya səthinin dördü birini, təxminən qırx milyon kvadrat kilometr ərazini əhatə edir. Buraya Çinin cənub-qərbində (Sıçuan, Yunnan, Çunqinq və Quanxi) və şimal-qərbində olan əyalətlər (Ningxia, Qinghai, Gansu, Shaanxi, Sincang) daxildir. Layihə çərçivəsində ölkələr maliyyə, nəqliyyat, enerji, kənd təsərrüfatı, telekommunikasiya və turizm kimi mühüm sahələrdə bir-birini tamamlayıcı olduqları üçün milli iqtisadiyyatların qarşılıqlı əməkdaşlığı üçün qlobal potensial bazar həcminə malikdirlər. “İpək Yolu İqtisadi Kəməri” üç marşrutdan ibarətdir: birincisi, Çindən başlayaraq Mərkəzi Asiya və Rusiyadan keçməklə Avropaya, ikincisi, Orta Asiya və Qərbi Asiyadan keçərək Fars körfəzi və Aralıq dənizinə, üçüncüsü isə Çindən Cənub-Şərqi Asiya, Cənubi Asiya və Hind okeanına qədər uzanır. Sözügedən üç marşrutdan ikisi Mərkəzi Asiyadan keçir, ona görə də demək olar ki, Mərkəzi Asiya İpək Yolu iqtisadi kəmərinin inşasında mərkəzi mövqə tutur. Mərkəzi Asiya ölkələri həyata keçirdikləri islahatlar və layihələrlə dünya ticarətinə uyğunlaşmaq və zəngin təbii ehtiyatlarından istifadə edərək sürətli iqtisadi artıma nail olmaq istəyirlər. Eyni zamanda Çin və Mərkəzi Asiya ölkələrinin əksəriyyəti sərhəd qonşuları olduqları üçün də coğrafi üstünlüklərə malikdirlər.

Dəniz İpək Yolu Cənub-Şərqi Asiyanın əsas ərazisi və Cənubi Asiya yarımadası, Şimal-Şərqi Asiya, Cənub-Şərqi Asiya, Cənubi Asiya, Qərbi Asiya, Afrika, Avropa və digər regionlar daxil olmaqla geniş ərazini əhatə edir. Dəniz İpək Yolunun iki marşrutu var:

Qərb xətti - Bura Cənubi Çin dənizi, Hind okeanı və Atlantik okeanında yerləşən ölkələr, həmçinin Cənub-Şərqi Asiya, Cənubi Asiya, Qərbi Asiya, Şərqi Afrika və Avropa regionları daxildir.

Cənub xətti - Cənubi Çin dənizindən Cənubi Sakit okeanın ada ölkələrinə çəkilir və Cənub-Şərqi Asiya, Avstraliya, Sakit okean adalarını əhatə edir.

Dəniz İpək Yolu Çin sahillərindən cənuba, Hanoydan keçməklə Cakarta, Sinqapur və Kuala-Lumpura birləşərək Şri-Lanka Kolombo vasitəsilə Malakka boğazı vasitəsilə Maldiv adalarının paytaxtı Male vasitəsilə Hindistanın cənub ucuna doğru uzanır. Şərqi Afrika Mombasa, oradan Cibutiyə, sonra Qırmızı dəniz vasitəsilə Süveyş kanalı vasitəsilə Aralıq dənizinə, oradan Hayfa, İstanbul və Afina vasitəsilə Yuxarı Adriatik bölgəsinə, oradan da Mərkəzi Avropa və Şimal dənizi ilə dəmir yolu ilə əlaqəsi olan, beynəlxalq pulsuz limanı olan İtaliyanın şimalındakı Trieste mərkəzinə qədər uzun bir yol keçir. Nəticədə, Polşa, Baltıqyanı ölkələr, Şimali Avropa və Mərkəzi Avropa da Dəniz İpək Yolu ilə birləşir və Adriatik limanları və Pirey vasitəsilə Şərqi Afrika, Hindistan və Çinlə logistik cəhətdən əlaqələndirilir. Dəniz marşrutu malların daşınması vaxtını ən azı dörd gün qısaldır. Dəniz İpək Yolu Çini Mərkəzi Asiya ölkələri və dünya ilə birləşdirici körpü hesab olunur. Buna görə də Çinin strateji təhlükəsizliyini gücləndirir. Mövcud marşrutların baha olması və Ədən körfəzi və Malakka boğazından yaranan təhlükəsizlik problemləri Dəniz İpək Yolunun əhəmiyyətini artırır.

“Bir Kəmər Bir Yol” strategiyasının Orta Dəhliz Layihəsi Türkiyədən dəmir yolu ilə Gürcüstan, Azərbaycan, Xəzər dənizindən bərə ilə Türkmənistan, Qazaxıstan və Uyğur Muxtar Vilayətinin paytaxtı Urumçidən keçməklə Sian şəhərinə qədər uzanan dəhlizin yaradılması planlaşdırılır. Orta dəhliz Şimal və Cənub dəhlizlərinə alternativ yaratmaqla layihənin əhəmiyyətini artırır. Çin Müasir İpək Yolu Layihəsi çərçivəsində Orta Dəhliz üçün 8 trilyon dollarlıq büdcə nəzərdə tutur və bu büdcənin 40 milyard dollarını nəqliyyat şəbəkələrinə xərcləməyi planlaşdırır. Müasir İpək Yolu layihəsi Çinə və digər ölkələrə yeni imkanlar yaradacaq iqtisadi əməkdaşlıq layihəsidir. İpək Yolunun üç qitəyə (Asiya, Avropa və Afrika) təsirini və bu üç qitədəki iqtisadiyyatların ticarət (malların daşınması), təbii qaz-neft boru kəmərləri ilə birləşməsi nəzərə alınmaqla, ölkələrə iqtisadi sahədə əhəmiyyətli qazanclar gətirəcək.

“Bir kəmər, bir yol” layihəsinin **geosiyasi əhəmiyyəti** aşağıdakılarla müəyyən olunur:

- ✓ dəmir yolları, avtomobil yolları və boru kəmərləri vasitəsilə Çini Asiya və Avropanın əhəmiyyətli hissəsinə daşıyacaq;
- ✓ 65 ölkəni əhatə edən böyük bir layihədir;
- ✓ layihənin ən azı 50 və ya 100 illik perspektivi olduğu təxmin edilir;
- ✓ 3 milyarddan çox insanın iştirak etdiyi trilyon dollarlıq investisiya tələb olunur.



Layihənin yaradacağı yeni geosiyasi mühitlə bağlı qeyri-müəyyənliklər bu layihəyə optimist və pessimist baxışların toqquşması ilə nəticələnir. Layihə ilə bağlı *optimist fikirlər* nəqliyyat imkanlarının genişləndirilməsi, şərq və qərb bazarlarının inteqrasiyası, ticarət artımı və mədəni əməkdaşlıq imkanlarının artırılması, yeni iqtisadi və siyasi modellərin istehsalı və regional münaqişələrin şiddətinin azaldılmasıdır. Layihə ilə bağlı *pessimist fikirlər* ondan ibarətdir ki, Çin hegemonluğu qərbə və ABŞ-a qarşı yüksələ bilər və Çin mərkəzli şərq qərbə qarşı yeni iqtisadi və siyasi qütb təşkil edə bilər.

Son illərdə Çin ucuz işçi potensialı və investisiyaları ilə əhəmiyyətli artım rəqəmləri göstərir. Bu iqtisadi artımın davamlılığını qorumaq üçün Müasir İpək Yolu Layihəsi ilə qlobal xarici siyasətdə daha çox söz sahibi olmağı hədəfləyir. Bu yolla Çin xüsusilə güclü olduğu sektorlarda edəcəyi investisiyalarla daha qısa müddətdə beynəlxalq bazarlara çıxacaq. Müasir İpək Yolunun Çin üçün ən mühüm üstünlüyü ticarətin dəniz yolundan asılılıqdan xilas olmasıdır. Bundan başqa, marşrutda olan ölkələrlə siyasi əlaqələrin artması gözlənilir. Bu yolla Çinin bütün dünyada effektivliyini əhəmiyyətli dərəcədə artıracağını gözləyir [2].

“Bir kəmər, bir yol” layihəsinə daxil olan ölkələr aşağıdakılardır:

Şərqi Asiya: Çin, Monqolustan;

Cənub-Şərqi Asiya: Bruney, Kamboca, İndoneziya, Laos, Malayziya, Myanma, Filippinlər, Sinqapur, Tayland, Timor-Leste, Vyetnam;

Orta Asiya: Qazaxıstan, Qırğızıstan, Tacikistan, Türkmənistan, Özbəkistan;

Orta Şərq və Şimali Afrika: Bəhreyn, Misir, İran, İraq, İsrail, İordaniya, Küveyt, Livan, Oman, Qətər, Səudiyyə Ərəbistanı, Fələstin, Suriya, Birləşmiş Ərəb Əmirlikləri, Yəmən;

Cənubi Asiya: Əfqanıstan, Banqladeş, Butan, Hindistan, Maldiv adaları, Nepal, Pakistan, Şri Lanka;

Avropa: Türkiyə, Ukrayna, Albaniya, Azərbaycan, Belarusiya, Bosniya və Herseqovina, Xorvatiya, Çex Respublikası, Estoniya, Ermənistan, Gürcüstan, Macarıstan, Latviya, Litva, Makedoniya, Moldova, Çernoqoriya, Polşa, Rusiya, Serbiya, Slovakiya, Sloveniya,.

Çin tərəfindən irəli sürülən “Bir kəmər, bir yol” layihəsinin əsas məqsədi bütövlükdə Asiya və Avropa qitəsini birləşdirməkdir. Bu məqsədlə Çin həm Cənubi Qafqaz, həm də Cənub-Şərqi Asiya ölkələri ilə ticarət, ticarət yolları sahəsində bir çox müqavilələr imzalayıb.

Son illərdə Orta Asiyada mövcud olan istinad nöqtəsini gücləndirən Çin Cənubi Qafqaz regionunda da nüfuzunu artırmaq məqsədi güdür. Bu məqsədlə Gürcüstanla daha yaxından əməkdaşlıq edilir. Belə ki, Çinin şirkətlərinin Gürcüstanın limanlarına çıxışının olması, tikinti şirkətlərinin ölkədəki fəallığı bu əməkdaşlığa sübut kimi göstərilə bilər [4].

Çin tərəfindən irəli sürülən bu təşəbbüsə dəstək verən ilk ölkələrdən biri Azərbaycan olmuşdur. Bu da illər ərzində Çin və Azərbaycan arasında olan dostluq münasibətlərinin nəticəsidir desək yanlışdır. Azərbaycan Şərq və Qərbin, Şimal və Cənubun qovşağında yerləşməklə ölkələr arasında körpü rolunu oynayır. Buna görə də istər Qədim İpək Yolu, istərsə də Müasir İpək yolu layihəsində ölkəmiz qovşaq, logistika mərkəzi rolunu oynayır.

Azərbaycan və Çin arasında mövcud olan münasibətlərin tarixi kökləri qədim zamanlara, təxminən, Qafqaz Albaniyasının mövcud olduğu dövrlərə gedib çıxır. Tarixi İpək yolu vasitəsilə Çindən yola düşən dəvə karvanları, yüklər bu ərazilərdən keçib gedirdi. Azərbaycan ərazisi qədimdən Şərqlə Qərbi birləşdirən körpü rolunu oynamışdır. Çin ilə Azərbaycan arasında mövcud olan münasibətlər XIII-XV yüzilliklərdə daha da artmışdır. Ərdəbil, Təbriz, Gəncə, Marağa, Bakı, Naxçıvan, Bərdə, Şamaxı, Şəmkir, Şəki, Dərbənd kimi Azərbaycan şəhərləri bu münasibətlərdə daha yaxından iştirak edirdilər. Sonrakı əsrlərdə də Böyük İpək yolu öz əhəmiyyətini itirməyərək bu əlaqələrin davam etməsində vasitəçilik etmişdir. Azərbaycan SSRİ-nin tərkibində olduğu 70 il ərzində bütün əlaqələr mərkəzdən tənzimlənirdi [5].

Müstəqillik əldə edən Azərbaycan Respublikası Çin Xalq Respublikası ilə ikitərəfli əlaqələrin yaradılması üçün mühüm addımlar atmışdır. Bu əlaqələrin təməli ümummilli lider Heydər Əliyevin Çinə 1994-cü ilin mart ayında olan rəsmi səfəri zamanı qoyulub desək yanlışdır. Daha sonralar isə



prezident İlham Əliyev tərəfindən həyata keçirilən rəsmi səfərlər bu əlaqələri daha da inkişaf etdirmişdir.

Çin dövləti tərəfindən öz xarici iqtisadi əlaqələrini dərinləşdirməkdən ötrü irəli sürülən “Bir kəmə, bir yol” layihəsi Azərbaycan üçün yeni, mühüm əməkdaşlıq perspektivləri yaradır. Azərbaycan layihəni dəstəkləyən ilk ölkələrdən olmuşdur. Azərbaycan hökuməti həyata keçirilən müxtəlif görüş və beynəlxalq miqyasda olan tədbirlərdə dəfələrlə bəyan etmişdir ki, ölkəmiz bütün nəqliyyat-tranzit imkanları və iqtisadi potensialı ilə layihənin həyata keçirilməsinə dəstək verilməsinə hazırdır [6].

Dünya İqtisadi Forumu çərçivəsində Davosda 22 yanvar 2019-cu il tarixində “Bir kəmə, bir yol” təşəbbüsünün inkişaf etdirilməsi: Çinin trilyon dollarlıq baxışı” mövzusunda sessiya keçirilib. Azərbaycan Respublikasının Prezidenti İlham Əliyev və Birinci vitse-prezident Mehriban Əliyeva forumda iştirak ediblər. Qitələri birləşdirən Bakı-Tbilisi-Qars dəmir yolunun inşası, dəmir yolları sistemlərinin müasir standartlara uyğun qurulması, Xəzər dənizinin sahilində 25 milyon tona qədər yük daşıma qabiliyyəti olan müasir liman tikintisinin olmasının ölkəmizin logistika mərkəzi kimi digər dövlətlərlə əlaqələrində mühüm əhəmiyyətə malik olduğu xüsusi vurğulanıb.

2019-cu ilin aprelin 26-da Pekin şəhərində II “Bir kəmə, bir yol” Beynəlxalq Əməkdaşlıq Forumu işə başlayıb. Cənubi Qafqazda yerləşən ölkələrdən yalnız Azərbaycan bu foruma dəvət alıb. Bu da göstərir ki, Çin strategiyanın həyata keçirilməsində Azərbaycanla əməkdaşlığı dərinləşdirmək niyyətindədir. Forumda 37 dövlət başçısı və beynəlxalq təşkilatların rəhbərləri iştirak ediblər. Forumda Rusiya, Azərbaycan, Qazaxıstan, Avstriya, Pakistan, Çexiya, Belarus, Macarıstan, Yunanıstan, Sinqapur, Serbiya, İtaliya kimi dövlətlərin liderləri qatılıblar. Açıılış mərasimində çıxış edən ÇXR Sədri Si Cinpin bildirib ki, hazırda 150-dən çox ölkə, bir sıra beynəlxalq təşkilatlar “Bir kəmə, bir yol” layihəsini dəstəkləyir. Eyni zamanda bildirib ki, bu layihə dünya inkişafında yeni mərhələdir. Müxtəlif ölkələr arasında əməkdaşlığı daha da inkişaf etdirəcək strategiya qədim zamanlardan mövcud olan İpək yolu üzərində yeni dəyərlərin formalaşmasına da töhvə verəcək. Bundan başqa, beynəlxalq miqyasda yüklərin tez və təhlükəsiz daşınmasına, milli gəlirlərin artmasına, qloballaşmanın iqtisadiyyata mənfi təsirlərinin azalmasına, regional inkişafa, mədəni-humanitar əlaqələrin genişlənməsinə də səbəb olacaq [3].

Azərbaycanda 1 oktyabr 2015-ci il tarixində nəqliyyat infrastrukturunu və yol əlaqələrini yaxşılaşdırmaq üçün Tranzit Yükdəşimələr üzrə Koordinasiya Şurası təsis edildi. Daşınma, tranzit yüklərin dəmir yolu və dəniz nəqliyyatı ilə daşınması, dəniz terminallarında köçürmə kimi sahələrdə ümumi tarif siyasətini müəyyən etmək Şuranın əsas məqsədidir.

Azərbaycan özünün logistika imkanlarını yaxşılaşdırmaq üçün aşağıdakı layihələri həyata keçirmişdir: 6 beynəlxalq hava limanı, 6 Bakı yük terminalı, Xəzər dənizində yük donanması, Bakı Beynəlxalq Dəniz Ticarət limanı, Abşeron Logistika Mərkəzi və Bakı-Tbilisi-Qars dəmiryolu xətti.

Bakı Beynəlxalq Dəniz Ticarət Limanı və Bakı-Tbilisi-Qars kimi mühüm layihələr “Bir kəmə, bir yol” təşəbbüsü üçün böyük əhəmiyyətə malikdir. Ən son texnoloji avadanlıqlarla təmin olunan, müasir əməliyyat sistemləri ilə işləyən liman onlayn rejimdə yük sahiblərinə imkan verir ki, yükün getdiyi yolu izləyə bilsinlər. Bu cür rəqəmsal formaya keçirilmiş marşrutların olması ticarət dövriyyəsinə də müsbət təsir edəcək.

Ölkəmizdə qədim İpək yolunun bərpası, logistik mərkəzlərin yaradılması, yükdəşimələrdə prosedur qaydalarının sadələşdirilməsi, elektron xidmətlərin göstərilməsi ondan xəbər verir ki, ölkəmiz artıq strateji nəqliyyat dəhlizi mərkəzinə çevrilmişdir. Dəmir yollarının müasirləşməsinə diqqət artırılması sayəsində bu sahə regionun nəqliyyat-logistika nəhənginə çevrilmişdir. Bu baxımdan Bakı-Tbilisi-Qars dəmir yolunu xüsusi vurğulamaq lazımdır. Son illərdə Azərbaycanın həyata keçirdiyi ən böyük layihələrdən biri də Bakı-Tbilisi-Qars dəmir yolu xəttidir. 2017-ci ildə tamamlanan dəmir yolu xətti vasitəsilə 2034-cü ilədək 17 milyon ton yük, 3 milyon sərnişin daşınması planlaşdırılır. Həmçinin Bakı-Tbilisi-Qars dəmir yolu xəttindən istifadə edilərək Trans-Xəzər marşrutu boyunca Orta Dəhlizlə daşınma həyata keçirildiyi zaman Şimal dəhlizi ilə müqayisədə 15 günə qədər vaxta qənaət edilə bilər. Azərbaycan Çin-Mərkəzi və Qərbi Asiya marşrutu üzərində “Orta dəhliz” adlanan ərazidə yerləşir. Bakı-Tbilisi-Qars dəmiryolu xəttinin



açılması və işğal altında olan Azərbaycan torpaqlarının azad edilməsi “Orta dəhliz”in əhəmiyyətini daha da artırmışdır. Orta Dəhliz iqliminə görə daha əlverişlidir və 2000 km daha qısa məsafə qət edilir. Bu da nəticədə gəlirliyi artırıb nəqliyyat xərclərini azaltmağa kömək edir. Verilən ilkin proqnozlara görə, “Orta dəhliz”ə təxminən 8 trilyon dollar investisiya qoyulacaq. 40 milyard dollar dəyərə malik olacaq yük daşımalarının ən az 5, ən çox 10 faizinin Bakı-Tbilisi-Qars dəmir yolu və Bakı Beynəlxalq Dəniz Ticarət Limanı vasitəsilə həyata keçiriləcək. Bu da Azərbaycanın milyardlarla dollar gəlir əldə edəcəyi deməkdir [8].

Dünya bankının çoxsaylı tədqiqatlarına əsasən deyə bilərik ki, “Bir kəmə, bir yol” layihəsi iştirakçı ölkələrdə ticarət axınlarını təxminən 4,1% artırmaqla, Eyni zamanda, global ticarət xərclərini 1,1% azalda bilər, inkişaf etməkdə olan ölkələrin ümumi daxili məhsulunu orta hesabla 3,9% artırmaqla.

Londonun İqtisadi və biznes tədqiqatları mərkəzinin hesablamalarına görə, layihənin 2040-cı ilə qədər dünya ÜDM-ni ildə 7,1 trilyon dollar artıracağı müəyyən edilmişdir.

Ümumdünya Pensiya Şurasının (WPC) hesabatında Çin istisna olmaqla, Asiyada növbəti onillikdə ildə 900 milyard ABŞ dollarına qədər infrastruktur sərmayəsinə ehtiyac var.

Artıq dünyada olan bütün konteynerlərin yarısından çoxunu əhatə edən Dəniz İpək yolu marşrutu üzrə dəniz limanları genişləndirilir, logistik qovşaqlar tikilir, yeni nəqliyyat marşrutları yaradılır. “Bir kəmə, bir yol” layihəsi çərçivəsində infrastruktur layihələri təxminən 4-8 trilyon ABŞ dollarına başa gələcək. Strategiyanın layihələri İpək Yolu Fondu və Asiya İnfrastruktur İnvestisiya Bankından maliyyə dəstəyi alır. Çin 2014-cü ildə 40 milyard ABŞ dolları dəyərində olan İpək Yolu Fondunu yaratdı və Asiya İnfrastruktur İnvestisiya Bankını (AIIB) əlavə vəsaitlərlə təmin etdi [9].

25 oktyabr 2019-cu il tarixində Bakı şəhərində Bakı Biznes Mərkəzində “Dayanıqlı İnkişaf Məqsədləri (DİM) istiqamətində Bir Kəmə, Bir Yol təşəbbüsünün birgə yaradılması üçün Azərbaycanın milli siyasət potensialının gücləndirilməsi” üzrə ilk yerli seminar keçirildi. Seminar iştirakçıları nazirliklərin və akademiya və təşkilatların nümayəndələri, texniki ekspertləri, həmçinin “Bir kəmə, bir yol” layihəsinin inkişaf tərəfdaşları idi. “Bir kəmə, bir yol” layihəsinin investisiyalarının Azərbaycanda Dayanıqlı İnkişaf Məqsədlərinə (DİM) olan təsirini artırmaq üçün vahid siyasət yaratmaq və sahədə olan təcrübələri paylaşmaq seminarın əsas məqsədi idi. Seminarın əsas vəzifələri bunlardan ibarətdir:

- “Bir kəmə, bir yol” layihəsinin hazırda mövcud olan vəziyyətini və Azərbaycanda Dayanıqlı İnkişaf Məqsədlərinə təsirini araşdırmaq;
- “Bir kəmə, bir yol” - Dayanıqlı İnkişaf Məqsədləri əlaqələrini düzgün müəyyənləşdirmək üçün planları, milli strategiyaları, maliyyə çərçivələrini müzakirə etmək;
- “Bir kəmə, bir yol” - Dayanıqlı İnkişaf Məqsədləri layihəsi zamanı meydana çıxma biləcək problemləri və onların həlli yollarını müzakirə etmək;
- “Bir kəmə, bir yol” - Dayanıqlı İnkişaf Məqsədləri layihəsi zamanı iştirakçı tərəflər arasında mövcud əməkdaşlığı dərinləşdirmək.

Birləşmiş Millətlər Təşkilatının İqtisadi və Sosial Məsələlər Departamenti tərəfindən icra olunan və maliyyələşdirilməsi təşkilatın Sülh və İnkişaf Fondu tərəfindən həyata keçirilən layihə texniki heyət və siyasətçilər üçün Azərbaycan və digər 13 pilot ölkədə təlimlər keçirib. Pilot ölkələr Qazaxıstan, Qırğızıstan, Azərbaycan, Gürcüstan, Banqladeş, Çexiya, Kamboca, Monqolustan, Rumıniya, Myanma, Şri-lanka, Serbiya, Tayland, Laosdur [8].

“2030-cu ilədək dayanıqlı inkişaf sahəsində Gündəlik”də əks olunan Dayanıqlı İnkişaf Məqsədləri BMT-nin “Minilliyin İnkişaf Məqsədləri” Bəyannaməsinin davamı olaraq qəbul olunmuşdur. BMT-nin 2015-ci ilin sentyabr ayında keçirilən sammiti zamanı qəbul edilmiş Dayanıqlı İnkişaf Məqsədləri universal xarakter daşıyaraq hər kəsi əhatə edir və “heç kəsi kənarda qoymamaq” prinsipini rəhbər tutur. Nəzərdə tutulan məqsədlər sırasında eyni zamanda bərabərsizliklə mübarizə və ona qarşı tədbirlər, yoxsulluğa son qoymaq, iqlim dəyişikliyinə qarşı mübarizə də var. Bu sənəd özündə 17 məqsədi, 244 göstəricini, 169 hədəfi birləşdirərək BMT-nin 193 ölkəsi tərəfindən qəbul edilmişdir.



“Bir kəmər, bir yol” layihəsinin qarşıya qoyulan məqsədlərinin icra mexanizmi 5 əsas plan nəticəsində formalaşdırılır. Bu planların da BMT-nin “2030-cu ilədək dayanıqlı inkişaf sahəsində Gündəlik”də əks olunan Dayanıqlı İnkişaf Məqsədləri ilə birbaşa əlaqəsi var. 5 əsas prioritet aşağıdakı kimidir:

1. Siyasətlərin əlaqələndirilməsi - əsasən hökumətlərarası makro siyasətin mübadiləsi, əməkdaşlığın təşviqi nəzərdə tutulur. Azərbaycan və Çin şirkətləri 2019-cu ilin aprel ayında 10 yeni əməkdaşlıq müqaviləsi imzalamışlar. Ümumilikdə 821 milyon ABŞ dolları dəyərində olan sazişlərə aşağıdakı tikinti planları daxildir:

- Kürdəmirdə 300 hektar ərazidə istixana kompleksi;
- Avtomobil şinləri istehsal etmək üçün Sumqayıt Kimya Sənaye parkı;
- Göyçay, Quba, Xaçmazda aqrosənaye inkişaf parkları.

Bundan başqa, 2500 konteynerin Azərbaycan ərazisindən Trans-Xəzər nəqliyyat dəhlizi ilə tranzitin əlaqələndirilməsi, Asiya-Avropa telekommunikasiya dəhlizinin əsasının qoyulması, Azərbaycan şərabinin Çinə ixracı üzrə sazişlər imzalanıb.

2. Əlaqələrin asanlaşdırılması – burada qarşıya qoyulan əsas məqsəd infrastruktur sahəsində inşaat planlarının və texniki standartların yaxşılaşdırılmasıdır. 2015-ci ilin dekabr ayında Prezident İlham Əliyevin Çinə rəsmi səfəri çərçivəsində memorandum imzalanmışdır. “Azərbaycan Respublikası Hökuməti və Çin Xalq Respublikası Hökuməti arasında İpək Yolu İqtisadi Kəmərinin yaradılmasının birgə təşviqinə dair Anlaşma Memorandumu” adlanan sənəd əlaqələrin asanlaşmasında mühüm əhəmiyyətə malikdir. Eyni zamanda “Azərbaycan Respublikasında logistika və ticarətin inkişafı üzrə Strateji Yol Xəritəsi” Azərbaycan Prezidentinin fərmanı ilə təsdiq olunmuşdur. Əsas hədəf şaxələndirilmiş, rəqabətə davamlı, dayanıqlı iqtisadiyyat yaratmaqdan ibarətdir.

3. Maneəsiz ticarət – adından da bəlli olduğu kimi ticarət maneələrinin azaldılması əsas məqsəddir. Azərbaycan üçün maneəsiz ticarətin əhəmiyyəti böyükdür. Son illərdə Azərbaycanın ixracatının böyük hissəsi Avropa, daha sonra Asiya ölkələrindədir.

4. Maliyyə inteqrasiyası – əsas məqsəd maliyyə sahəsində pul siyasətinin düzgün formalaşdırılmasına və maliyyə institutlarının qurulmasına köməklik göstərməkdir.

5. İnsanlar arasında birbaşa əlaqə - elmi, mədəni və milli istiqamətlərdə insanlar arasında mübadilənin və əməkdaşlığın gücləndirilməsinə dəstək verir. Bu zaman viza rejiminin sadələşdirilməsi turizmin inkişafına birbaşa təsir edir. Son vaxtlarda bəzi ölkələrin vətəndaşları Azərbaycanda birbaşa hava limanlarında viza ala bilərlər. Bu da turistlərin sayında artıma səbəb olur. Bəhs edilən prioritetin bir hissəsi kimi təhsil sahəsində Azərbaycanın və Çinin Təhsil Nazirlikləri arasında olan əməkdaşlığı göstərə bilərik [1].

“Bir kəmər, bir yol” layihəsinin yaratdığı imkanlar təkcə nəqliyyat sahəsi ilə yekunlaşmır. Eyni zamanda turizmin, ticarətin, xalqlar arasında olan əlaqələrin daha da təkmilləşməsinə şərait yaradır. Bununla da bütövlükdə Avrasiya məkanında sülhün, sabitliyin, təhlükəsizliyin bərqərar olmasına xidmət edir.

NƏTİCƏ

Nəticə etibarilə deyə bilərik ki, “Bir Kəmər, bir yol” layihəsinin reallaşması ilə Asiya ilə Avropa arasında inteqrasiyanın daha da dərinləşməsi gözlənilir. Şərqlə Qərbin bu yollar üzərindən yaxınlaşmasının marşrut üzərində olan ölkələrə kapital axını və məşğulluğun artırılması baxımından fayda verəcəyi, milli gəliri artıracığı və aşağı iqtisadi potensiala malik ölkələrdə inkişafı sürətləndirəcəyi gözlənilir. Müasir İpək Yolu layihəsi ciddi iqtisadi-kommersiya potensialına malikdir. Bundan əlavə, yeni enerji müqavilələrinə yol açacaq layihə enerji bazarlarında dinamizmi təmin edəcək.

Şərqlə Qərb arasında əlverişli mövqedə yerləşən Azərbaycan malik olduğu bu üstünlükdən istifadə edərək inkişafa şərait yaradır. Şərq-Qərb və Şimal-Cənub beynəlxalq layihələrinin həyata keçirilməsində çox fəal iştirak edərək özünün tranzit və logistik imkanlarını genişləndirir. Qlobal əhəmiyyət daşıyan “Bir kəmər, bir yol” layihəsində iştirak etməklə də Azərbaycan çox böyük üstünlüklər əldə edəcəkdir. Bu üstünlüklər özünü qeyri-neft sektorunun inkişafında, beynəlxalq



yükdaşımaların həcminin, müxtəlif mənbələrdən daxilolmaların həcminin, ölkəyə daxil olan valyuta həcminin, dövlət gəlirlərinin artımında göstərəcək. Həmçinin ticarətin asanlaşması, ixracın strukturunun təkmilləşməsi, iqtisadiyyatın diversifikasiyası, xarici investisiyaların ölkəyə axımının artımı da gözlənilir. Yaxın gələcəkdə Azərbaycan-Çin əlaqələri daha da dərinləşəcək. İnvestisiya, ticarət, maliyyə kimi müxtəlif iqtisadiyyat sahələrində əməkdaşlıq daha da genişlənəcək. Bütün bunlar “Bir kəmər, bir yol” strategiyasının uğurla həyata keçirilməsi nəticəsində proqnozlaşdırılır.

Ədəbiyyat

- 1.E.İbrahimov “Bir kəmər, bir yol” layihəsi:”İpək yolu iqtisadi kəməri” və “21-ci əsr Dəniz İpək yolu” adlı məqalə - “Biznes həyatı” jurnalı, avqust,2020;
- 2.E.Günay, S.Çetiner, S.Sevinç, E.Kütükçü – “Tarihi İpək yolundan Modern İpək yolu projesinə: Türkiyə-Çin ekonomik iş birliyi çərçevesində orta koridor ilə Bir kuşak, bir yol girişimi” adlı məqalə;
- 3.Azərbaycan Respublikası Prezidentinin rəsmi internet saytı - <https://president.az/>
- 4.BBC News Azərbaycanın rəsmi saytı - <https://www.bbc.com/azeri>
- 5.“Geostrategiya” beynəlxalq ictimai-siyasi, elmi-nəzəri jurnalı - <https://geostrategiya.az/>
- 6.“Xalq qəzeti” gündəlik ictimai-siyasi qəzet - <https://xalqqazeti.com/>
- 7.Türkiyə Radio və Televiziya Qurumunun rəsmi internet səhifəsi - www.trt.net.tr/azerbaycan
- 8.United Nations “Jointly building Belt and Road towards Sdgs” - <https://www.brisdgs.org/>
- 9.Wikipedia onlayn ensiklopediya - <https://az.wikipedia.org/>



AHLAKİ GERÇEKÇİLİK VE LİDERLİK KAVRAMI

Kübra Zeyrek

Çanakkale On Sekiz Mart Üniversitesi, Lisansüstü Eğitim Enstitüsü, Uluslararası İlişkiler Tezli Yüksek Lisans, Kayseri, Türkiye

Özet

Çin, yükselişe geçmesi ile beraber uluslararası alanda kendi perspektifini yansıtan teoriler ortaya çıkarmaya başlamıştır. Bu teoriler oluşturulurken Zhou Hanedanlığı dönemi düşünce ekolleri baz alınmıştır. Uluslararası alana Çin bakış açısıyla yorum katan kişilerden biri Yan Xuetong'dur. Teorisi Ahlaki Gerçekçilik'tir. Bu teori realizmde ahlak kavramının olduğunu savunur. Yan Xuetong çalışmasında bu teoriyi lider kavramı üzerinden değerlendirmiştir çünkü ona göre lider ülkeyi ya da uluslararası alanı nasıl yönetirse ülke ve uluslararası alan öyle şekillenir. Yan'e göre liderlik kavramı devlet yönetimine ve uluslararası sistemin yönetimine göre farklılıklar gösterir. Doğaları gereği iki sistem birbirinden farklıdır. Yan, liderlik kavramlarını sınıflandırırken Konfüçyüsçü (儒家/ Ru Jia) ekolden olan Xunzi'nin (荀子) düşüncelerinden yola çıkmıştır. Her bir liderlik ideasının hangi politik felsefeyi benimsediğini ve stratejik önceliklerinin neler olduğunu belirtmiştir. Bu çalışmada Yan Xuetong'un liderlik algısı üzerinde durulacaktır. Yan'in önem verdiği insancıl otorite kavramı ele alınacaktır.

Anahtar Kelimeler: Çin, Yan Xuetong, Liderlik, Ahlaki Gerçekçilik

MORAL REALİSM AND LEADERSHIP

Abstract

With its rise, China has begun to reveal theories that reflect its own perspective in the international area. When creating these theories, the schools of thought of the Zhou Dynasty were taken as a basis. Yan Xuetong is one of the people who comment on the international area from a Chinese perspective. His theory is Moral Realism. This theory argues that there is a concept of morality in realism. Yan Xuetong focuses on this theory through the concept of the leader, because according to him, the country and the international area are shaped as the leader manages the country or the international area. According to Yan, the concept of leadership has differences between the state administration and the management of the international system. Naturally the two systems are different from each other. While classifying the concepts of leadership, Yan based on Xunzi (荀子) leadership thoughts, he was from the Confucian (儒家/ Ru Jia) school. He stated which political philosophy each leadership idea adopted and what its strategic preferences were. This study will focus on Yan Xuetong's perception of leadership. The concept of humane authority, which Yan attaches importance to, will be discussed.

Keywords: China, Yan Xuetong, Leadership, Moral Realism



HATAY SOKAK LEZZETLERİNİN GASTRONOMİ TURİZMİ AÇISINDAN DEĞERLENDİRİLMESİ

Aykut Kan EREN

Okan TÜRK

Muş Alparslan Üniversitesi, Sosyal Bilimler MYO, Ulaştırma Hizmetleri Bölümü, Muş, Türkiye

Özet

Sokak lezzetleri kavramı, yiyecek-içecek, işlenmiş gıdalar ve atıştırılmalıklardan oluşan heterojen bir kavram olarak karşımıza çıkmaktadır. Günümüzde değişen insan yaşantısında tüketilen yiyecek ve içecekler kadar beslenme kavramı da önem kazanmaya başlamıştır. Özellikle orta ve düşük gelirli gruplar ve çocuklar tarafından düzenli bir şekilde tüketildiği ortaya konmuş olan sokak lezzetleri, toplumsal beslenmenin önemli bir bileşeni haline gelmiştir. Neredeyse dünyanın her yerinde toplumların kültürlerini yansıtan sokak lezzetleri temaları bulunmaktadır. Anadolu topraklarının en eski yerleşim yerlerinden birisi olan Hatay'ın bilinen tarihi Orta Paleolitik döneme kadar uzanmaktadır. Mezopotamya'dan Akdeniz'e açılan önemli bir coğrafik konum üzerinde bulunması, Hatay bölgesinin tarihte her zaman önemli bir coğrafya olmasını sağlamıştır. Bölgede egemenlik sürmüş olan Roma İmparatorluğu, Akat Beyliği, Tolunoğulları, İhşitler, Selçuklular, Bizans İmparatorluğu, Memlük Devleti, Osmanlı İmparatorluğu ve Türkiye Cumhuriyeti'nin kültürel birikim ve çeşitliliği bölgede zengin bir yöresel mutfak kültürünün gelişimine katkıda bulunmuştur. Humus, Arap Tavası, Aşur, Acılı Ezme, Abugannuc, Biberli Ekmek, Muhammara, Kammuni Biberli Aş, Künefe ve İskenderun Döneri gibi yöresel lezzetlere sahip olan Hatay, gastronomi turizmi açısından önemli bir turistik destinasyondur. Günümüzde turist beklentilerinde yaşanan değişimler ve farklılık arayışları gastronomi turizminin vazgeçilmez bir parçası olan sokak lezzetleri konseptinin önemini artırmıştır. Hatay yöresel mutfağına ait olan birçok ürün sokak lezzetleri kapsamına uygunluğu ile dikkat çekmektedir. Özellikle sokak lezzetleri kapsamına uygun olan Antakya Döneri, tatlı çeşitleri ve unlu mamul ürünleri bu konseptin şehir genelinde varlığını göstermesi ve gastronomi turizminin desteklenmesi için önemli ürünler olarak görülmektedir. Bu nedenle bu çalışmada Hatay yöresel mutfağında bulunan sokak lezzetlerinin gastronomi turizmi potansiyeli açısından değerlendirilmesi amaçlanmıştır. Bu amaç doğrultusunda konuya ilişkin ikincil veri kaynaklarından elde edilen bilgiler doğrultusunda SWOT Analizi yöntemi ile değerlendirmeler yapılarak çeşitli önerilerde bulunulmuştur.

Anahtar Kelimeler: Sokak lezzetleri, Gastronomi Turizmi, Hatay Yöresel Mutfak Kültürü



EVALUATION OF HATAY STREET DELICACIES IN TERMS OF GASTRONOMY TOURISM

Abstract

The concept of "street delicacies" emerges as a heterogeneous concept consisting of food and beverage, processed foods, and snacks. Today, the concept of nutrition has become as important as the food and beverages consumed in a changing human life. Street delicacies, which have been revealed to be consumed regularly by middle- and low-income groups and children, have become an important component of social nutrition. There are street delicacy themes that reflect the cultures of societies almost everywhere in the world. The known history of Hatay, one of the oldest settlements of Anatolian lands, dates back to the Middle Paleolithic period. The fact that it is located on an important geographical location from Mesopotamia to the Mediterranean has always made the Hatay region an important geographical region in history. The cultural accumulation and diversity of the Roman Empire, the Principality of Akkat, the Tulunids, the Ikhshidides, the Seljuks, the Byzantine Empire, the Mamluk State, the Ottoman Empire, and the Republic of Turkey, which dominated the region, contributed to the development of a rich local culinary culture in the region. Hatay, which has local delicacies such as Hummus, Arabian Pan, Ashur, Hot Spicy Tomato Dip, Abugannuc, Peppered Bread, Muhammara, Kammuni Peppered Food, Kunefe, and Iskenderun Doner, is an important tourist destination in terms of gastronomy tourism. Today, the changes in tourists' expectations and the search for different experiences have increased the importance of the concept of street delicacies, which is an indispensable part of gastronomy tourism. Many products belonging to Hatay local cuisine draw attention with their suitability for street delicacies. Especially suitable for street delicacies, Antakya Doner, types of dessert and bakery products are considered as important products to show the existence of this concept throughout the city and to support gastronomy tourism. Therefore, in this study, it was aimed to evaluate the street delicacies in Hatay local cuisine in terms of gastronomy tourism potential. For this purpose, various recommendations are offered by performing evaluations using the SWOT Analysis method and the information obtained from secondary data sources related to the subject.

Keywords: Street delicacies, Gastronomy Tourism, Hatay Local Culinary Culture

GİRİŞ

Günümüz dünyasında insanların değişime gösterdiği tolerans seviyelerinin çok büyük olmasına karşılık hiçbir zaman değiştiremeyeceği şeylerin başında gıda tüketimi gelmektedir. Abraham Maslow, ortaya koymuş olduğu İhtiyaçlar Hiyerarşisi'nde gıda tüketiminin insan hayatındaki ve psikolojisindeki temel yapı taşı olduğunu göstermektedir (Maslow, 2019). Sanayi devrimi ile başlayan insan yaşantısındaki değişimler yemek kavramını artık sadece hayatta kalma güdüsü olmaktan çıkartmış ve beslenme kavramını hayatlarımıza dahil etmiştir. Beslenme ile yemek kavramı aynı fiziksel eylemleri ifade etmelerine rağmen toplumsal ve kültürel olarak farklı çağrışımlar meydana getirmektedir. Beslenme ile anlatılmak istenen olgu yemek kavramından farklı olarak bir kontrol alanını ifade etmektedir (Solunoğlu ve Nazik, 2018). Sokak lezzetleri kavramı da bu beslenme ve kontrol alanları içerisinde en çok tercih edilen konseptlerden birisi haline gelmiştir. Gerek kullanılan malzemelerin seçimindeki serbest alan sahası gerekse zamandan tasarruf edilebilmesi ve kültürel unsurları barındırabilmesi açısından değişen turist tercihleri arasında önemli



bir yere sahip olan sokak lezzetleri, gastronomi turizmi açısında da temel yapı taşlarından birisi haline gelmiştir.

Toplumların en önemli kültürel öğelerinden birisi olan yemek unsuru sadece yaşamın devam ettirilmesinden öte bir anlam taşıyarak törelerin, dinsel merasimlerin, festivallerin ve daha birçok kültürel unsurun temellerinden birisi halini almıştır (Beşirli, 2010, Babat, Gökçe ve Varışlı, 2017). Uygarlıkların en uğrak noktalarından birisi olmuş olan Hatay bölgesinde de yaşanan değişimler ve kültürel birikimler bölge mutfağına da büyük oranda yansımıştır. Mezopotamya'dan Akdeniz'e açılan önemli bir coğrafik konum üzerinde bulunması, Hatay bölgesinin tarihte her zaman önemli bir coğrafya olmasını sağlamıştır. Bölgede egemenlik sürmüş olan Roma İmparatorluğu, Akat Beyliği, Tolunoğulları, İhşitler, Selçuklular, Bizans İmparatorluğu, Memlük Devleti, Osmanlı İmparatorluğu ve Türkiye Cumhuriyeti'nin kültürel birikim ve çeşitliliği bölgede zengin bir yöresel mutfak kültürünün gelişimine katkıda bulunmuştur (T.C. Hatay Valiliği, 2022). Çorbalar, mezeler, et yemekleri ve hamur işleri ile sokak lezzetleri konusunda da oldukça geniş bir zenginliğe sahip olan Hatay mutfağı gastronomi turizmi kapsamında önemli bir potansiyele sahiptir. Bu sebeple çalışmada gastronomi turizmi ve sokak lezzetleri kavramları ele alınarak Hatay ilinin yöresel mutfak kültürü ve sahip olduğu sokak lezzetleri değerlerinin gastronomi turizmi açısından potansiyeli incelenecektir.

GASTRONOMİ TURİZMİ VE SOKAK LEZZETLERİ

Gıda tüketim kavramını insanlık tarihiyle eşit olmasına rağmen bilimsel anlamda hayatlarımıza dahil olması yakın geçmişe dayanmaktadır. Gastronomi kavramı kelime anlamı olarak Yunanca gastri (mide) ile nomos (yasa, kurallar) (Sarıışık ve Özbay, 2014) sözcüklerinden meydana gelmektedir ve ilk olarak Arcestratus'un tarihte ilk yemek kitabı olarak kabul edilen şiirinde geçmektedir (Özdemir ve Altınar, 2019). İlk ele alınmasından bu yana kavramsal olarak hakkında birçok tanım geliştirilmiş olan gastronomi en temelinde yiyecek ve içeceklerin nasıl kullanılması gerektiğini gösteren, kültürler arasındaki farklılıkları ortaya koyan ve tüketilecek olan gıdaya bölgenin sahip olduğu tarihi, kültürü ve gelenekleri işleyen bir bilim dalı olarak karşımıza çıkmaktadır (Küçükkömürler, Şirvan ve Sezgin, 2018). Gastronomi, “mutfak kültürü içerisinde bulunan yiyecek ve içeceklerin, lezzetlerini, sofr düzenlerini, görselliklerini, yapıları ve bunlar arasındaki ilişkileri inceleyen, lezzetli yemekler ile hoş içecekleri araştıran ve bu aktiviteye katılanlar tarafından sanatsal bir faaliyet olarak isimlendirilen bir disiplin” şeklinde tanımlanmaktadır (Şengül ve Türkay 2016). TDK (2022) ise gastronomiyi; “sağlığa uygun, iyi düzenlenmiş, hoş ve lezzetli mutfak, yemek düzeni ve sistemi” ve “yemeği iyi yeme merakı” olmak üzere iki farklı biçimde tanımlamaktadır. Gastronomi turizmi ise “destinasyon ziyaretlerinde kişilerin çeşitli yiyecek-içecekleri deneyimleme, farklı lezzetlerin üretim aşamalarını gözlemleme, farklı mutfak kültürlerini inceleyebilme gibi istekleri ile meydana gelen, seyahat ve konaklama kavramlarını da içinde barındıran ilişkiler bütünü” şeklinde tanımlanmaktadır (Esen ve Seçim, 2020). Şengül ve Türkay (2016) gastronomi turizmini; “yöresel mutfak kültürünü tanımak, yöreye özgü bir lezzetin tadımını yapmak, bölge coğrafyasına ait ürünlerin toplanmasını ve yetiştirilmesini görmek, mutfağına ait folklorik araç ve gereçleri tanımak, ünlü restoranların yemeklerini yemek amacı ile gerçekleştirilen bir turizm türü” olarak ifade etmektedir.

Özellikle son 20 yıldır teknoloji ve ekonomik alanında yaşanan gelişmeler ile bireylerdeki beslenme alışkanlıkları ve yeni şeyler keşfetme arzularında büyük değişimler görülmüştür. Gastronomi turizmi, turistlerdeki yeni olgular keşfetme arzusunun karşılayabilen bir turizm çeşidi olarak turizm faaliyetlerinin temel yapı taşlarından birisi haline gelmiştir. Gastronomi turizminin en önemli unsurlarından birisi de sokak lezzetleri olarak karşımıza çıkmaktadır. Sokak lezzetleri, Gıda ve Tarım Organizasyonu (Food and Agriculture Organization, FAO) tarafından en basit şekliyle özellikle sokak ve benzeri alanlarda satıcılar tarafından hazırlanan ve/veya yemeye hazır yiyecek ve içecekler olarak tanımlanmaktadır. Sanayi devrimi sonrası iş hayatında yaşanan değişimlerden dolayı evde yemek hazırlama, mesai saatleri sırasında yemek ile harcanacak zaman darlığı gibi konular sebebiyle bireyleri sokak lezzetlerini tüketmeye itmektedir. Sosyal yaşantıdaki değişimlere ek olarak



turist beklentilerindeki deęişimler ve çeşitli gıda öğelerinin sosyal medya sayesinde dünyadaki her birey için daha farkına varılabilir olduğundan dolayı gastronomi turizminin içerisinde vazgeçilemez bir yer edinmiştir. Günümüzde turizm faaliyetlerine katılım sağlayan bireyler, destinasyon seçimlerinde kriter olarak bölgenin yeme-içme kültürünü de dikkate almaktadırlar. Hatta bazen sadece bu kültürel öğeleri deneyimlemek için bölgeyi ziyaret etmektedirler (Demir, Akdağ, Sormaz ve Özata, 2018). Hem bölge halkının beslenme şekillerini ve istihdam alanlarını etkilemesinden dolayı hem de turistik bir ürün olarak gastronomi turizminin önemli bir parçası olması sebebiyle sokak lezzetleri kavramı farklı bölgelerde birçok araştırmacı tarafından önemli bir unsur olarak görülmüş ve farklı çalışmalara konu olmuştur.

Ballı (2016), yaptığı araştırmasında Adana sokak lezzetlerini konu almış, sokak lezzetlerinin gastronomi turizmindeki yerini incelemiş ve Adana ilinin sahip olduğu sokak lezzetlerinin önemini ve yerini kaleme almıştır. Ayrıca çalışmasında sokak lezzetlerinin geliştirilmesi ve tanıtılması açısından bölgeye yönelik önerilerde bulunmuştur.

Bayraktar ve Zencir (2019), sokak lezzetlerine yönelik İzmir ilinde gerçekleştirdikleri çalışmada sokak satıcılarının gözünden değerlendirmelerde bulunmuş, elde ettiği veriler ışığında sokak lezzetlerinin sağlık ve hijyen boyutunu, ekonomik boyutunu, tüketici boyutunu, mesleki görüşleri ve kadın çalışanların rollerini başlıklar altında değerlendirmiştir. Çalışma sonucunda çalışma koşullarının yeterli olmadığını ve satıcıların yaşadığı kaygılar ile mesleki zorlukları belirlemiş ve bu unsurların giderilmesi için önerilerde bulunmuştur.

Demir, Akdağ, Sormaz ve Özata (2018), İstanbul'un sahip olduğu sokak lezzetlerine yönelik yaptıkları çalışmalarında, geniş bir kültürel birikime ve nüfusa sahip olan bölgelerin sokak lezzetlerine yönelik önemli bir istihdam kaynağı barındırdığını ve genç bireyler için önemli birer beslenme unsuru olduğunu belirtmiştir. Ayrıca kadın çalışanların yaratılan istihdamdan da faydalanabildiklerini ve sokak lezzetlerinin kültürel, ekonomik ve beslenme açısından önemli bir kaynak olduğunu aktarmıştır.

Sokak lezzetlerinin sahip olduğu kültürel ve ekonomik değerler yapılan bu çalışmalarda gösterilmiş ve farklı bölgelerde de olsa aynı pozitif etkinin yaratılabileceği akademik çalışmalar ile kanıtlanmıştır. Sokak lezzetlerine yönelik bir diğer önemli unsur ise sokak lezzetlerinin sağlık boyutudur.

Alimi (2016), yaptığı çalışmasında gelişmekte olan ülkelerde sokakta satılan yiyecekleri incelemiş ve gerçekleştirilen uygulamaların risk faktörlerini araştırmıştır. Alimi, gerçekleştirdiği çalışmasında bu risk faktörlerini tarımsal uygulamalar, çiğ gıda ve bileşenlerin kalitesi, yiyeceklerin hazırlanma aşamaları, çevre koşulları ve hijyen uygulamaları olarak belirlemiştir. Bu risk faktörlerinde oluşacak herhangi bir olumsuzluğun toplum sağlığının genelini riske atabileceğini ve bu risklerin sadece satıcılara yönelik uygulanacak eğitimler ile minimum seviyeye indirilebileceğini aktarmıştır.

Rane (2011), ise sokak lezzetlerinin tehlike analizini incelediği çalışmasında tehlike kaynağı olarak özellikle mikrobik riskleri göstermiştir. Satıcıların buldukları konumun, işlenmiş gıdaların, ekipmanların, hijyen uygulamalarının ve gıdalardaki saklama koşullarının olumsuz olması durumunda farklı spor ve patojenlerin gıdaya ve tüketiciye kolaylıkla enfekte olabildiğini göstermiştir.

Yapılan bu çalışmalar göstermektedir ki sokak lezzetleri kavramı sadece basit bir gıda tüketimi değildir. Taşıdığı kültürel, ekonomik, sağlık ve beslenme unsurları hem toplumların ihtiyaçlarını karşılamakta hem de önemli bir gastronomi turizmi unsuru oluşturmaktadır.



HATAY YÖRESEL MUTFAK KÜLTÜRÜ VE SOKAK LEZZETLERİ

Akdeniz bölgesinin doğu sınırı olarak kabul edilen bir coğrafya üzerinde bulunan Hatay hem tarihi konumu hem de ticaret rotaları üzerinde bulunması sebebiyle birçok medeniyete ev sahipliği yapmıştır. Akadlar, Hurriler, Mısır Medeniyeti, Persler, Memlûklular, Roma, Bizans ve Osmanlı gibi imparatorluklara ev sahipliği yapmış olan Hatay bölgesinde her bir medeniyetin mirası olarak değerlendirilen kültürel zenginlikler ile doludur. Bu kültürel zenginlik Hatay mutfağına da fazlasıyla yansımıştır. Yaklaşık olarak 600 çeşit yemeğin bulunduğu Hatay Unesco tarafından ‘‘Gastronomi Şehri’’ olarak değerlendirilmiştir (Cömert, 2014). Geniş kapsamlı olarak tanımlanmış olan Hatay mutfağına ait yöresel lezzetler Şekil 1’de gösterilmektedir.

Et Yemekleri	Sebze Yemekleri	Bulgurlu Yiyecek ve Aşlar	Çorbalar	Dolma ve Sarmalar	Mezeler ve Salatalar	Hamur İşleri	Tatlı ve Reçeller	Süt Ürünleri ve Yiyecekler
<ul style="list-style-type: none">• Tepsi Kebabı• Kağıt Kebabı• Arap Kebabı• Aşur• Tirit• Mortadella• Tuzda Tavuk• Kimyonlu Köfte• Belen Tavası• Antakya Usulü Tavuk Döner• Antakya Usulü Kıyma Kebabı• Maklube	<ul style="list-style-type: none">• Mücver• Şıh Mualle• Kabak Bastırma• Darbalı Bastırma• Bamya• Borulce• Kabak Boraniye• Ispanak Boraniye• Şıhlı Mahşi• Aya Köfteli Ispanak Sapı• Zeytinyaplı Pazı Sapı	<ul style="list-style-type: none">• Tepsi Oruğu• Oruk (İçli Köfte)• Domatesli Aş• Kimyonlu Biberli Aş• Mercimekli Aş• Firikli Aş• Çiğ Kote• Kabaklı Aş• Keşürlü Piriç Pilavı (Kapuska)• Sarma İçi (Kısır)• Patatesli Köfte• Sırayıl	<ul style="list-style-type: none">• Kumbursiye• Toğga Çorbası• Ekşi Aşı• Yoğurt Aşı• Tuzlu Yoğurt Çorbası• Mahulta• Aya Köfteli Çorba• Şişbörök• Ekşili Çorba	<ul style="list-style-type: none">• Etil Lahana Sarma• Patlıcan Dolması• Kuru Patlıcan Dolması• Zeytinyağlı Yaprak Sarma• Zeytinyağlı Zalk Sarması• Mumbar	<ul style="list-style-type: none">• Bakla• Ali Nazik• Cevizli Biber• Humus• Tarator• Turplu Tarator• Havuçlu Tarator• Abugannuş• Zengin• Roka Salatası• Zahter Salatası• Zeytin Salatası	<ul style="list-style-type: none">• Kete• Kerebiç• Kömbe• Külçe• Semirsek• Ispanaklı Börek• Kaytaç Böreği• Biberli Ekmek• Katıklı Ekmek	<ul style="list-style-type: none">• Peynirli İrmin Helvası• Künefe• Kabak Tatlısı• Taş Kadayıfı• Züngül• Şam Tatlısı• Haytalı• Keppet Reçeli• Patlıcan Reçeli• Ceviz Reçeli• Turunç Reçeli• Ayva Reçeli	<ul style="list-style-type: none">• Künefelik Peynir• Cara (Testi) Peyniri ve Çökeleği• Sürk (Çökelek)• Küflendirilmiş Sürk• Burma Peynir• Ezme Peynir• Tuzlu Yoğurt

Şekil 1. Hatay Yöresel Mutfak Ürünleri

Coğrafik konum ve iklim şartları olarak bakıldığında da Hatay önemli ürünleri bünyesinde bulundurmaktadır. Bölgede doğal olarak yetişen 2000 üzerinde bitki türü bulunmaktadır ve bunların 300 kadarı endemik bitki türleridir. Yine bölgenin iklim koşulları sebebiyle süt ve süt ürünlerinde kendine has aromalar olduğu görülmektedir. Nar ekşisi ve zeytinyağı gibi ürünler de Hatay mutfağında kullanılan ve bölgesel üretimin yoğun olduğu ürünlerdendir (Babat, Gökçe ve Varışlı, 2017). Bunların yanında çorba çeşitleri, meze ve salatalar, sebze ve et yemekleri, tahıl ürünleri, tatlılar ve unlu mamul çeşitleri yoğun olarak bulunmaktadır (Ray ve Demirtaş, 2019). Abugannuş, Cevizli Biber, Humus, Zeytin Salatası, Kekik Salatası, Çökelek Salatası, Sarmaıçi, Öcce, Kaytaç Böreği, Aşşür, Şam Oruğu, Maklube, Peynirli Künefe ve Kabak Tatlısı bölgenin başlıca lezzetleri arasında gelmektedir (Hatay Gastronomi). Bu ürünler ağırlıklı olarak sokak lezzetleri konseptine uygunluğu ile de dikkatleri çekmiştir. Yoğun bir servis aşamasına ihtiyaç duyulmadan hazırlanıp tüketilecek olan bu ürünler ile Hatay ilinde sokak lezzetlerinin önemli bir bölümünü oluşturmaktadır. Özellikle endemik bitkilerden üretilen ürünler, baharatlar ve reçeller hem sokak satıcıları tarafından hem de belirli satış noktalarında faaliyet gösteren satıcılar için önemli birer sokak lezzeti ürünleridir. Antakya Usulü Döner ve tatlı çeşitleri gibi fast food ürünleri ile paket servisine uygunluğu ile



mezeler sokak lezzetlerinin Hatay ilinde yaşatılması, kültürel öğelerin yayılması ve gastronomi turizmi açısından çekicilik unsuru oluşturmaları bakımından önemli ürünler olarak görülmektedir.

HATAY SOKAK LEZZETLERİNİN GASTRONOMİ TURİZMİ AÇISINDAN DEĞERLENDİRİLMESİ

SWOT Analizi, bir firmanın, bir sektörün, bir faaliyetin güçlü ve zayıf taraflarını belirlemekte, dış çevrelerden kaynaklanan fırsat ve tehditleri saptamakta kullanılan bir teknik olarak belirtilmektedir (Ongun, Gövdere ve Çiçek, 2016, 84). SWOT, İngilizcedeki güçler (strengths), zayıflıklar (weaknesses), fırsatlar (opportunities) ve tehditler (threats) kelimelerinin baş harflerini içeren bir kısaltmadır. SWOT Analizi yöntemiyle ilin sokak lezzetlerinin gastronomi turizmi potansiyeline yönelik güçlü ve zayıf yönleri tespit edilmeye ve kentte sokak lezzetlerinin gastronomi turizminin gelişimine yönelik oluşturduğu fırsatlar ve tehditler saptanmaya çalışılmaktadır. Bu kapsamda Hatay sokak lezzetlerinin gastronomi turizmi potansiyeli açısından değerlendirilmesine ilişkin SWOT Analizi Tablo 1’de verilmektedir.

Tablo 1: Hatay Sokak Lezzetlerinin Gastronomi Turizmi Potansiyeli Açısından Değerlendirilmesine İlişkin SWOT Analizi

Güçlü (Strengths) Yönler	Zayıf (Weaknesses)Yönler
<ul style="list-style-type: none">✓ Hatay Sokak Lezzetlerinin köklü bir kültürel birikim sonucunda oluşması,✓ Hatay’ın zengin bitki çeşitliliğine sahip olması ve bu çeşitliliğin sokak lezzetleri üzerindeki etkisi,✓ Hatay’ın ticaret rotaları üzerinde olması nedeniyle kültürel etkileşimin çok fazla olmasının sokak lezzetlerini zenginleştirilmesi,✓ Hatay’ın kıyı şeridinde bulunan limanların ekonomik etkisi nedeniyle çalışma yaşamının yoğun olmasının sokak lezzetleri gelişimi üzerindeki etkisi,✓ Hatay’ın mevsimsel gıda çeşitliliğinin sokak lezzetlerini zenginleştirilmesi,✓ Hatay yerel mutfak kültüründe meze ve salata tarzı aperatif yiyeceklerin çeşitliliğinin sokak lezzetlerini zenginleştirilmesi,✓ İlde gastronomi turizmine ilişkin yatırımların kamu kurum ve kuruluşları tarafından desteklenmesi.	<ul style="list-style-type: none">✓ Hatay’ın sokak lezzetlerine ilişkin doğrudan gerçekleştirilen tanıtım faaliyetlerindeki yetersizlik,✓ Hatay’ın doğrudan sokak lezzetlerine ilişkin yerel yönetimler tarafından desteğin azlığı,✓ Hatay’ın yalnızca sokak lezzetlerine ilişkin festivallerinin olmaması,✓ İlde faaliyet gösteren işletmelerde sokak lezzetlerine ilişkin kalifiye personel eksikliği,✓ İldeki sokak lezzetleri satıcılarının sosyal medya kullanımındaki eksiklikler.
Fırsatlar (Opportunities)	Tehditler (Threats)
<ul style="list-style-type: none">✓ Hatay’ın uygun konaklama imkanlarına sahip bir destinasyon olması,✓ İlde farklı kültürlerle ait sokak lezzetlerinin bir arada sunulabilmesi,✓ İlde gastronomi turizminin en önemli bileşenlerinden birisi olan sokak lezzetleri entegre olarak kırsal turizm, inanç turizmi vb. gibi diğer turizm türlerinin yapılabilecek olması,✓ İlde sokak lezzetlerine yönelik eğitilebilecek genç nüfusun çoğunlukta olması,✓ İlde şehir içi ve şehirlerarası ulaşım ağının gelişmiş olması.	<ul style="list-style-type: none">✓ Hatay’ın sınır komşularında yaşanan iç savaş ve karışıklıklar,✓ Hatay’ın çevresinde yerel mutfakları ve sokak lezzetleri ile tanınmış rakip destinasyonların varlığı,✓ Covid 19 pandemisinin tüketici davranışları üzerindeki etkisi✓ Hatay Sokak lezzetlerine ait bazı yöresel ürünlerin il adına tescillenmemiş olması

SONUÇ

Hatay tarihsel birikimi, farklı kültürlerin bir arada yaşaması, endemik bitki çeşitliliği, iklimi vb. gibi etkenler nedeniyle zengin bir yöresel mutfak kültürüne sahiptir. Yöresel mutfak kültüründeki bu



çeşitlilik sokak lezzetlerine de yansımıştır. Bu nedenle Hatay sokak lezzetleri gastronomi turizmi potansiyeli açısından önemli bir çekicilik unsurunu oluşturmaktadır. Hatay sokak lezzetleri ilin gastronomi turizmi potansiyeli açısından değerlendirildiğinde köklü bir kültürel birikim sonucunda oluşması, zengin bitki çeşitliliği, çok fazla olan kültürel etkileşimin izlerini taşıması vb. gibi güçlü yönlerinin, tanıtım eksikliği, sokak lezzetlerinin sunulmasına ilişkin kalifiye personel eksikliği, yerel yönetimlerin desteğindeki eksiklikler vb. gibi zayıf yönlerinin, sokak lezzetlerinin farklı kültürlerle ait unsurları bir arada barındırması gibi fırsatlarının, çevresinde sokak lezzetleri ile tanınmış illerin olması, bazı sokak lezzetlerine ait ürünlerin il adına tescillenmemiş olması ve sınırlarında yaşanan iç karışıklıklar ve savaş gibi bir takım tehditlerinin olduğu görülmektedir. Bu noktalardan hareketle ilde sokak lezzetlerinin gastronomi turizmine yönelik bir çekicilik unsuru olarak geliştirilebilmesi adına ildeki sokak lezzetlerinin il adına tescillenmesi, sokak lezzetlerine ilişkin tanıtım faaliyetlerinin artırılması, sokak lezzetlerini sunan kişi ve restoranlarda çalışan personellerin sokak lezzetleri ile ilgili eğitilmesi, yerel yönetimlerin konu ile ilgili desteklerinin artırılması oldukça önemlidir.

KAYNAKÇA

- Alimi, B. A. (2016). Risk factors in street food practices in developing countries. *A Review. Food Science and Human Wllness*, 5(1), 141-148.
- Babat, D., Gökçe, F., ve Varışlı, A. (2017). Hatay mutfak kültürünün sürdürülebilirliğinde yöresel yiyecek üreticilerinin rolü. 1st International Sustainable Tourism Congress, 816-830.
- Ballı, E. (2016). Gastronomi turizmi açısından adana sokak lezzetleri. *Journal of Tourism and Gastronomy Studies*, 4(1), 3-17.
- Bayraktar, G., ve Zencir, E. (2019). Sokak satıcılarının gözünden sokak lezzetleri: izmir örneği. *Journal of Tourism and Gastronomy Studies*, 7(2), 1367-1382.
- Cömert, M. (2014). Turizm pazarlamasında yöresel mutfakların önemi ve hatay mutfağı örneği. *Journal of Tourism and Gastronomy Studies*, 2(1), 64-70.
- Demir, Ş., Akdağ, G., Sormaz, Ü., ve Özata, E. (2018). Sokak lezzetlerinin gastronomik değeri: istanbul sokak lezzetleri. *Güncel Turizm Araştırmaları Dergisi*, 2(1), 589-601.
- Esen, M. F., ve Seçim, Y. (2020). Yöresel mutfağın turizm ürünü olarak kullanımının yerel halk tarafından. *Journal of Tourism and Gastronomy Studies*, 8(1), 158-174.
- Food and Agriculture Organizastion (FAO), (2022). <https://www.fao.org/fcit/food-processing/streetfoods/en/#:~:text=Selected%20documents%201%20FAO%20%282009%29%20Go od%20Hygienic%20Practices,la%20v%C3%ADa%20p%C3%BAblica%20%28Estudio%20FAO%20alimentaci%C3%B3n%20y%20nutrici%C3%B3n%29> E.T.: 24.11.2022.
- Hatay Gastronomi, <https://hataygastronomi.com/yoresel-yemekler> E.T.:29.11.2022
- Hatay Valiliği, (2022). www.hatay.gov.tr/tarihsel-surec-icinde-hatay E.T.: 22.11.2022.
- Küçükkömürler, S., Şırvan, N. B., ve Sezgin, A. C. (2018). Dünyada ve Türkiye’de gastronomi turizmi. *Uluslararası Turizm Ekonomi ve İşletme Bilimleri Dergisi*, 2(2), 78-85.
- Maslow, A., H. (2019). *İnsan Olmanın Psikolojisi*. İstanbul: Kuraldışı Yayınları.
- Ongun, U., Gövdere, B., ve Çiçek, U. (2016). Yeşilova’nın kırsal turizm potansiyelinin swot analizi ile değerlendirilmesi. *Süleyman Demirel Üniversitesi Vizyoner Dergisi*, 7(16), 75-88.



INTERNATIONAL ASIAN CONGRESS ON CONTEMPORARY SCIENCES – VII

Özdemir, G., ve Altın, D., D. (2019). Gastronomi kavramları ve gastronomi turizmi üzerine bir inceleme. *Erzincan Üniversitesi Sosyal Bilimler Enstitüsü Dergisi*, 12(1), 1-14.

Rane, S. (2011). Street Vended food in developing world: hazard analyses. *Indian J. Microbiol*, 51(1), 100-106.

Ray, U. C., ve Demirtaş, N. (2019). Hatay mutfağı yöresel yemeklerinin turizm işletme belgeli lokanta mönülerinde kullanımı: Antakya örneği. III. Uluslararası Eğitim Bilimleri ve Sosyal Bilimler Sempozyumu, 1134-1143.

Sarışık, M., ve Özbay, G. (2014). Gastronomi turizmi üzerine bir literatür incelemesi. *Anatolia Turizm Araştırmaları Dergisi*, 26(2), 264-278.

Solunoğlu, A., ve Nazik, M., H. (2018). Sokak lezzetlerine ilişkin tüketici tercihleri: gaziantep örneği. *Journal of Tourism and Gastronomy Studies*, 6(3),40-59.

Şengül, S., ve Türkay, O. (2016). Akdeniz mutfak kültürünün gastronomi turizmi bağlamında değerlendirilmesi. *Journal of Tourism and Gastronomy Studies*, 4(1), 86-99.

TDK, (2022). <https://sozluk.gov.tr/> E.T.: 12.12.2022.



SAVUNMA SANAYİ EKONOMİ POLİTİĞİ ÇERÇEVESİNDE TEŞVİKLER: TÜRKİYE DEĞERLENDİRMESİ

Filiz Giray

Maliye, İİBF, Bursa Uludağ Üniversitesi, Bursa, Türkiye

ORCID: <http://orcid.org/0000-0002-8765-8248>

Özet

Savunma tüm ülkeler için ağırlığı farklılık gösterse de geçmişten günümüze önemini koruyan bir hizmet türü olmuştur. Savunma hizmetlerinin paydaşlarından biri savunma sanayidir. Savunma sanayi ekonomideki diğer sektörlerden farklı özelliklere sahip bir sektördür. Savunma hizmetleri ve savunma sanayini etkileyen iki temel unsur bulunmaktadır. Bunlar teknolojiye gelişim ve küreselleşmedir. Bu unsurlar, savunma teknolojisi politikalarının belirlenmesinde bazı kilit unsurların değişmesi sonucunu yaratmıştır. Bunların başında savunma sanayinin ekonomik politliğini önem kazanması gelmektedir. Özellikle güvenlikle lider güç olmayan ülkeler için savunma sanayinin ekonomik yönü öne çıkmaktadır. Bu çalışmanın amacı; savunma sanayinin ekonomi politliğini açıklayıp bu çerçevede savunma sanayinin ekonomik işlevlerini yerine getirmede teşviklerin etkilerini Türkiye özelinde incelenmektir. Çalışmada, savunma sanayinin performansını gösteren; ihracat, ithalat tutarları, dünya genelinde savunma şirketleri sıralaması içinde Türk savunma şirketlerinin yeri ve proje destekleri gibi göstergelere dayalı olarak değerlendirme yapılarak sektörün gelişimi için izlenecek teşvik politika önerileri yapılmaktadır.

Anahtar Kelimeler: Savunma Sanayi, Savunma Sanayi Teşvikleri, Türkiye’de Savunma Sanayi, Savunma Vergi Teşvikleri

INCENTIVES WITHIN THE FRAMEWORK OF THE ECONOMIC POLICY OF THE DEFENSE INDUSTRY: AN ASSESSMENT OF TURKEY

Abstract

Although the weight of defense varies for all countries, it has been a type of service that has maintained its importance from the past to the present. One of the partnerships of defense services is the defense industry. The defense industry is a sector that has different characteristics from other sectors in the economy. There are two main factors affecting the defense services and the defense industry. These are the development and globalization of technology. These factors have created the result of changing some key elements in determining defense technology policies. One of the most important of these is the importance of the economic policy of the defense industry. Especially for countries that are not the leading power with security, the economic aspect of the defense industry stands out. The aim of this study is to analyze the effectiveness of incentives provided by governments in this area from the point of view of Turkey in order for the defense industry to meet expectations on the economy and defense services. In the study, incentive policy proposals to be followed for the development of the sector are made by evaluating the performance of the defense



industry based on indicators such as export, import amounts, the location of Turkish defense companies in the ranking of defense companies around the world and project supports.

Keywords: Defense Industry, Defense Industry Incentives, Defense Industry in Turkey, Defense Tax Incentives

GİRİŞ

Ülkelerin bütçeleri içinde savunma harcamalarına ayırdıkları pay soğuk savaşın sonrası bir süre düşme eğilimi gösterse de savunma önemini koruyan bir hizmet olması bakımından tekrar devlet bütçeleri içinde nispi önemini korumuştur. Bir ülkenin savunmasının sağlanması, genellikle savunma ürünleri olarak ifade edilen geniş bir ürün grubunun (silah sistemleri ve diğer donanımlar gibi) insan gücüyle birleşimini gerektirir. Bu bileşimi sağlayan ise savunma sanayidir. Savunma sanayi sektörü, sivil sektörden farklılıklar göstermektedir. İleri teknolojik gelişim ve küreselleşme olguları savunma sanayinde değişimler yaratan iki temel unsurdur. İleri teknolojinin kullanıldığı alanların başında savunma sanayi gelmektedir. Bu durum savunma sanayinin ekonomi politikasını oluşturan bir unsurdur. Güçlü rekabet üstünlüğüne sahip savunma sanayi yüksek teknolojiye sahip olmayı gerektirmektedir. Yüksek teknoloji savunma sanayi, ülkelerin dışa bağımlılığını azaltma, potansiyel tehditlere karşı önemli teknolojik avantajlar sağlama gibi birtakım faydalar sağlayacaktır. Yüksek teknoloji savunma sanayi sivil ekonomi üzerinde de olumlu etkiler yaratabilmektedir. Dünyada savunma alanında izlenen politika yeni teknolojilerin “ikili kullanım (dual use)” politikasına dayanmaktadır. Bu bilinçle hareket eden ülkeler, yeni nesil teknolojiler geliştirme, modern savunma sistemleri ile verimliliği ve etkinliği artırma çabası içine girmişlerdir. Savunma sanayinin askeri ve ekonomik açısından yaratacağı olumlu etkileri sağlayabilmesi devlet tarafından sağlanan teşviklerle desteklenmesini gerektirmektedir. Bu teşvikler doğrudan sağlanan parasal teşvikler ve vergi teşviklerinden oluşmaktadır. Bu çalışmanın amacı, savunma sanayinin ekonomi üzerinde de beklentileri karşılayabilmesi için bu alanda hükümetler tarafından sağlanan teşviklerin etkinliğini Türkiye açısından analiz etmektir. Çalışmada savunma sanayi ekonomi politikası çerçevesinde, bu sanayinin temel nitelikleri askeri işlevleri yanında ekonomik işlevleri açısından açıklanacaktır. Savunma sanayinde hükümetler tarafından sağlanan teşvikler ve bunların sektörün gelişimindeki yeri anlatılacaktır. Takip eden bölümde Türkiye’de savunma sanayinin gelişimi ve teşviklerin yeri bazı verilerin yardımıyla incelenip, elde edilen bulgulara göre öneriler sonuç kısmında verilecektir.

1. SAVUNMA SANAYİNİN EKONOMİ POLİTİĞİ VE TEŞVİKLER

Temel kamusal hizmet olan savunma hizmetinin gerçekleştirilmesinde değişen koşullar gereği savunma sanayinin önemi artmıştır. Savunma sanayi, işlevsel açıdan üç ana gruba ayrılmaktadır: *Silah sistemleri*, komuta kontrol sistemleri, istihbarat ve erken uyarı sistemleri, haberleşme sistemleri ve benzerleri gibi özel amaçlı *yardımcı ekipmanlar* ve araçlar, yakıt, tıbbi ekipmanlar gibi *genel amaçlı ürünlerden* oluşmaktadır (Lifshitz, 2003:143).

Savunma sanayi, ekonomideki sivil olarak adlandırılabilen diğer sektörlerden farklı özelliklere sahip bir sektördür. Bu özellikleri gereği savunma sektörü klasik anlamda bir sektör olarak görülmemektedir. Savunma sanayini diğer sektörlerden ayırıcı özellikler şu şekilde sayılabilir (Lifshitz, 2003:143; Poole and Bernard, 1992:339):

- Savunma ürünleri genellikle askeri faaliyetlerde farklı işlevleri yerine getirirler ve çoğunlukla birbirlerinin yerini almazlar.



- Yaygın olarak savunma sanayinin diğer sanayilerle aynı segmente ait oldukları düşünülse de savunmada kullanılan ürünler çoğunlukla değiş-tokuş edilebilen ürünler değildir.

- Savunma sanayi diğer sanayilerden farklı olarak fiyatların uzun süren müzakerelerle belirlendiği ve performans maksimizasyonunun maliyet minimizasyonuna göre öncelikli olduğu politikleşmiş, korunan bir sanayidir.

- Savunma sanayinde faaliyette bulunan şirketlerin bir diğer ayırıcı özelliği yaptıkları işlerin farklı olmasıdır. Şöyle ki bu firmaların faaliyetleri; araştırma-geliştirme (Ar-Ge), büyük miktarlarda seri üretim, küçük miktarlarda entegrasyon sistemleri veya bakım ve lojistik destek şeklindedir (Lifshitz, 2003:144).

- Savunma sanayinde dışa bağımlılık ülkelerin dış borç sorunu yaşamalarına neden olabilmektedir.

1990'larla birlikte iki unsur savunma sanayini önemli ölçüde değiştirmiştir. Bunlardan biri küreselleşme diğeri ileri teknolojidir. Küreselleşme, birçok alanda olduğu gibi savunma sanayini de etkilemiştir. Küreselleşme yerli ve yabancı savunma şirketi arasındaki ayrımı bulanıklaştırmıştır. Gizlilik unsuru azalmıştır. Bu ayrımı sürdürmeyi amaçlayan politikaların ulusal güvenlik veya savunma sanayine yardımcı olamadığı görülmektedir. Ayrıca küreselleşme, birçok yönden ulusal hükümetler karşısında savunma şirketlerinin elini güçlendirmiştir (Guay, 2007:v, 63). Küreselleşme, dünya genelinde bölgesel olarak sanayileşmeyi yaygınlaştırarak bölgelerin güçlenmesi bunun sonucunda güç dengelerinin değişerek hegemonya savaşlarına da yol açmıştır (Şişman, 2017:228).

İleri teknolojinin kullanıldığı modern savunma sistemi, savunma ve sivil sanayiler arasında açık sınırı kaldırmıştır. Yukarıda sayılan farklılıkları azaltmıştır. Savunma sanayi yoğunlaşmış bir pazarda inovasyon için birçok fırsat ve kaynak ortaya çıkmaktadır (Poole and Bernard, 1992:339). Modern savunma teknolojisi birçok ileri teknoloji içerir. Günümüzde savunma teknolojisi politikalarının benimsenmesinde aşağıda yazılı olan kilit unsurlar konusundaki değişim etkili olmuştur (Jan, 2005):

- *Silahlar Savaş Kabiliyetine Eşdeğerdir*: Günümüzde sayısal olarak sahip olunacak silah veya ekipman bir ülkenin savunma gücünün göstergesi olmaktan çıkmıştır. Modern savaş sistemleri, özel askeri kapasiteyi ve etkili olabilecek çevresel koşulları gerektirir.

- *Yabancı Ekipman Yurtiçi Üretimden yüksektir*: Askeri silah ve teçhizatın yurtdışından alınması savunma alanın Ar-Ge yatırımları ve üretimi azaltacaktır. Örneğin Tayvan için yapılan bir çalışmada 1990'lardan 2000'li yılların başlarına kadar ülkede izlenen silah satın alma politikasının büyük ölçüde yurtdışından doğrudan alıma dayandırılması Ar-Ge'de istihdam edilen işgücünün yarıda düşmesine neden olduğu belirtilmektedir (Jan, 2003:352). Yabancı silahlar bazı mükemmel işlevselliklere sahip olsalar da, daha sonraki yeni teknolojik gelişmelerle uyumlu olmayabilirler.

- *Gelişmiş Silahlanmaya İlişkin Yatırımlar Ulusal Ekonomiyi Olumsuz Etkileyebilir*: Bu görüş geçerliliğini kaybetmiştir. Özellikle ABD, Japonya, Singapur, Avrupa ülkeleri gibi askeri alanda lider konumundaki ülkeler, ulusal sanayileşme sürecini desteklemek, ekonomik kalkınmayı harekete geçirmek için ulusal savunma sanayi politikalarını benimsedikleri görülmektedir. Savunma sanayi hem yüksek teknolojiyi kullanan hem de savunma Ar-Ge'leri ile ileri teknoloji arzını sağlamaktadır.

- *Bağımsız Ar-Ge Askeri Talepleri Karşulamak için Çok Yavaştır*: Ülkelerin savunma sanayi alanında uzun vadeli planlar yapmamaları halinde bu sorun ortaya çıkabilmektedir. Uzun vadeli planın olmaması uluslararası askeri alımları beraberinde getirecektir.

- *Ar-Ge Birimlerinin Askeri Yönetimi Gelişimi Kontrol Altında Tutulabilir*: Bu görüşün ileri sürülmesinde Ar-Ge'nin otonomi ve yaratıcılık gerektirdiği, askeri bir komuta zincirine dayanan sistemin nispi olarak etkin olamayacağı belirtilmektedir. Ancak 1990'lardan sonra birçok ülkede özelleştirmeler nedeniyle savunma sanayinde özel sektör işletme anlayışı hakimdir. Örneğin Avrupa hükümetleri 1990'ların ortalarında savunma sanayilerinin bazı bölümlerini özelleştirdiği ve diğer



ülkelere sirayet ettiği görülmektedir (Guay, 2007:33). Ayrıca Özel şirketlerle kamu savunma sanayi ortaklıkları artmıştır.

İnovasyon Üretiminde Değişim: Soğuk Savaş sırasında, inovasyon büyük ölçüde askeri ve yerli savunma sanayisinden yapılan yatırımlardan kaynaklanmış ve savunma amaçlı özel olarak tasarlanmış teknolojiler tarafından üretilmiştir. Buna karşılık, günümüzde inovasyon giderek artan bir şekilde ticari sektör tarafından yönlendirilmekte ve üretimden sonra savunma amaçlarına uyarlanması gereken teknolojilerce üretilmektedir (FitzGerald and Sayler, 2014:9).

Savunma harcamalarının ekonomi üzerindeki etkilerinin altında yatan temel gerekçe, savunma Ar-Ge ve teknoloji ve bunun sivil ekonomi üzerindeki etkileridir. Böyle bir yargının gerekçeleri şu şekilde sıralanmaktadır (Dunne, Braddon, 2008: 35):

- Savunma Ar-Ge'leri vasıflı emeği sivil üretimden uzaklaştırabilir, ancak özellikle ordunun değerli beceriler sağlayabileceği gelişmekte olan ekonomilerde işçileri eğitebilir.

- Askeri sektörün gelişiminin sivil sektör üzerinde olumlu dışsallıkları olabilmektedir. Örneğin savunma alanında yüksek teknoloji bir yerleşim bölgesi oluşturmak için sivil sanayiden sermaye ekipmanı temin edilebilecektir.

- Askeri harcamalar, zarar verici savaflara yol açabilir. Ancak barışı koruyabilir ve daha müreffeh müttefiklerden ekonomik faydalara yol açabilir. Gerçekten de savaflar teknolojik gelişmeyi teşvik edebilir.

- Durgun bir ekonomide talebi teşvik edebilir ve büyümeye yol açabilir. Ancak bütçe kaynaklarının kısıtlı olduğu bir ekonomide darboğazlar yaratabilir.

- Militarist bir ideolojinin teşvik edilmesiyle ekonomik kalkınmayı yavaşlatabilir. Buna karşın milliyetçi tutumlar çabayı ve çıktıyı artırabilir ve askeri ve militarist ideoloji işgücünü kontrol etmek için kullanılabilir.

Savunma sanayi, güvenlik yanında sağladığı ekonomi politiği nedeniyle günümüzde sadece askeri alanda lider olan ülkeler değil tüm ülkeler açısından önem bir alandır. Bu bağlamda güçlü bir savunma sanayinin oluşturulması için savunma sanayileri hükümetler tarafından desteklenen alanların başında gelmektedirler. Ekonomik, mali ve sosyal amaçları gerçekleştirmek üzere hükümetler teşvikler uygularlar. Günümüzde bu destekler, yeni savunma sistemlerinin analitik zorluklarının karşılanması açısından çok daha önemli olmaktadır (Barber, 2015). Diğer bir ifadeyle savunma sanayii, geçmişe göre daha ticari, daha küresel ve finansal olarak daha karmaşık yapı arz etmektedir. Dolayısıyla bazı ülkelerde savunma sanayinin gelişimde güvenlik kaygısı ön planda iken bazılarında ekonomik amaçlar ön planda olabilmektedir. Örneğin ABD gibi hegemonik, endüstriyel güçlerin aksine, Kanada savunma sanayisinin siyasi yönetimi, güvenlik kaygılarından ziyade ekonomik kaygılardan kaynaklanmaktadır (Poole and Bernard, 1992:449). Bu durum hükümetlerin savunma sektörünü daha fazla desteklemeleri zorunluluğunu getirmektedir. Ayrıca ekonomik amaçlarla, savunma alanında ülkelerin dışa bağımlılığını azaltma ve savunma ürünlerinin ihracatını artırmak üzere savunma sanayinin desteklenmesi söz konusudur. Savunma sanayini desteklemek üzere hükümetler tarafından sağlanan mali teşvikler, devlet bütçesinden parasal ödemeler şeklinde yapılan *doğrudan teşvikler* ve *vergisel teşvikler* şeklindedir. Savunma Sanayi'nde tüm ülkelerde iki teşvik türü birlikte uygulanmaktadır. Çünkü savunma sanayi her iki teşvik türüne de ihtiyaç gösteren bir sektör konumundadır.

Savunma hizmetinin sunulması için gerekli teçhizat, sistem ve araç gereç savunma sanayi tarafından temin edilmektedir. Kamu ekonomisinde tam kamusal mal ve hizmetler olarak nitelendirilen savunma hizmetleri bu nitelikleri gereği devlet müdahalesini gerektirir. Bu müdahaleler regülasyon şeklinde olduğu gibi parasal ve vergisel teşvikler olarak da gerçekleştirilmektedir. Regülasyonlar çeşitli şekilde olabilmektedir. Hükümetler savunma sanayi için sadece fiyat regülasyonu yapmazlar



aynı zamanda ürünler de satın alırlar (Bkz. Rogerson, 1994). Teşvikler savunma sanayii desteklemek üzere geliştirilen mali araçlardır. Bu çalışma parasal ve vergi teşvikleri üzerine yoğunlaşmaktadır. Doğrudan devlet bütçesinden ödenen parasal destekler; hibe, bağış, sübvansiyon ödemeleri şeklinde olabilmektedir. Özellikle üretim girdileri üzerinden ödenen vergiler ürün maliyetini etkileyen unsurlardır. İstisna, muafiyet, indirim, vergi erteleme gibi vergi teşvikleri üreticileri finansal açıdan rahatlatacaktır.

2. TÜRKİYE’DE SAVUNMA SANAYİ VE TEŞVİKLER

Ülkemizde kamu savunma sanayi, daha önce Savunma Sanayi Müsteşarlığına bağlı iken sonra kurulan Savunma Sanayii Başkanlığının adı altında faaliyetlerine devam etmektedir. Faaliyetlerini bağlı ortaklıklar ve iştiraklerle de sürdürmektedir. Türk savunma sektörü 1990'lara kadar yurtdışından doğrudan tedarik üzerine odaklanmıştır. Bu durum başka ülkelere bağımlılık doğurmuştur. Başka ülkelere bağımlılığın yarattığı sonuçları Türkiye de yaşamıştır. Örneğin 1974 Kıbrıs Barış Harekâtı boyunca Türk hükümeti ambargo ile karşılaşmıştır. İthalat döviz sıkıntısı, bütçe açıkları sorunlarını da beraberinde getirmiştir. 1990'lı yıllarda doğrudan yurtdışından tedarike devam edilmesine rağmen Türk sanayi sektörü, yabancı şirketlerle ortak üretim programlarına başlamıştır. 2000'den sonra ise Türk savunma sektörü, eğitim uçakları (Hürkuş), savaş gemisi (Milgem), insansız hava aracı (Anka), Göktürk uydusu ve Altay tank projesini içeren mal hizmetlerin üretim ve ihracatını gerçekleştirmiştir (Ersöz, Karaman, 2011:21). Böylece savunma sanayi olarak ülke ekonomisine katma değer yaratma olanağı sağlanabilmiştir.

2.1. Savunma Sanayi ve Teşvikler

Ülkemizde savunma sanayini geliştirmek üzere çeşitli kanunlar ile teşvik uygulamaları bulunmaktadır. Bunların bir kısmı doğrudan parasal teşvikler şeklindedir. Bir kısmı ise vergi teşvikleridir. Ülkemizde kamu savunma sanayinin yararlandığı *parasal destekler*; Elektronik, Haberleşme, Uzay ve Havacılık Sektöründe Ar-Ge Projelerinin Desteklenmesi, 1003-Öncelikli Alanlar Ar-Ge Projeleri Destekleme Programı, Sanayi Tezleri Programı (SAN – TEZ), 1507- KOBİ Ar-Ge Başlangıç Destek Programı, İşbirliği – Güçbirliği Destek Programı, Ar-Ge, İnovasyon ve Endüstriyel Uygulama Destek Programı, Doğrudan Finansman Desteği, 1501- Sanayi Ar-Ge Projeleri Destekleme Programı, 1511- Öncelikli Alanlar Araştırma Teknoloji Geliştirme ve Yenilik Projeleri Destekleme Programı, İleri Teknoloji Projeleri (İTEP) Destek Programı, 1509- Uluslararası Sanayi Ar-Ge Projeleri Destekleme Programı, Teknolojik Ürün Yatırım Destek Programı, KOBİGEL Desteği'dir. Bu desteklere *proje destekleri* denilmektedir. Çünkü bu desteklerden yararlanmak, her biri için koşulları ilgili kanunlarla belirlenen projelerin hazırlanmasına bağlıdır. Bu destekleri bir kısmı hibe bir kısmı ise hibe ve geri ödemelidir. Finansal olarak şirketlere doğrudan katkı sağlayıcı teşviklerdir.

Ülkemizde en önemli destek grubu içinde yer alan proje destekleri 2014'den 2019 yılına kadar istikrarlı bir artış göstermesine karşın 2020 yılında düşmüştür. Artış oranlarının da çok yüksek olmadığı söylenebilir. 2019 yılına göre 2020 yılında azalma oranı % 31,69'dur (Şekil 1).

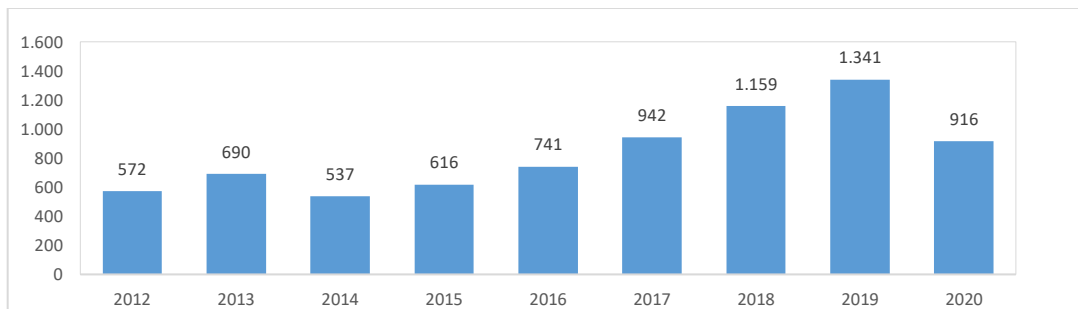

Şekil 1: Savunma Sanayi Proje Destekleri (Milyon \$)



Savunma sanayine verilen desteklerin bir kısmını da vergi teşvikleri oluşturmaktadır. Başlıca vergi teşvikleri; *Yazılım, Tasarım veya Ar-Ge Faaliyetlerinden Elde Edilen Kazançlarda Gelir/Kurumlar Vergisi İstisnası* (4691 sayılı Kanun), *Ar-Ge İndirimi* (5746 sayılı Kanun, 6550 sayılı Kanun), *Damga Vergisi İstisnası* (5746 sayılı Kanun), *Sınai Mülkiyet Haklarında Kurumlar Vergisi İstisnası* (5520 sayılı Kanun), *Ulusal Güvenlik Amaçlı Teslim ve Hizmetlere İlişkin İstisnası* (5520 sayılı Kanun) ve *Rekabet Öncesi İşbirliği Projeleri Desteği* (5746 sayılı Kanun)' dir. Ayrıca savunma sanayi yatırımları, 15 Haziran 2012 tarih ve 2012/3305 sayılı Bakanlar Kurulu Kararı kapsamında sağlanan vergi teşviklerinden yararlanmaktadır. Bu karar kapsamındaki teşvikler; *genel, bölgesel, stratejik ve öncelikli yatırımlar* şeklindedir. Savunma sanayi yatırımları dört başlıktaki tüm yatırımlar içinde yer almaktadır. Savunma sanayi yatırımları, yüksek teşviklerin uygulandığı öncelikli yatırımlar içinde yer alması sektörün gelişimi açısından önemlidir. Vergi teşviklerinin sayısı ve kapsamı dört yatırım türüne göre değişmektedir. Genel olarak savunma sanayi sektöründeki yer alan vergi teşvikleri; *katma değer vergisi istisnası, gümrük vergisi muafiyeti, vergi indirimi, sigorta primi işveren hissesi desteği, faiz veya kâr payı desteği, yatırım yeri desteği ve sigorta primi işçi desteğidir.*

Savunma sanayinde teknolojinin önem kazanmasıyla birlikte sağlanan hem parasal hem de vergisel teşviklerde Ar-Ge'lerin önemli yer tuttuğu görülmektedir. Siyasi nedenlerle askeri Ar-Ge yatırımlarını teşvik ederek savunma teknolojisi tabanını güçlendirmek amaçlanmaktadır. Hibe şeklindeki teşviklerde tavan konularak “maliyet kontrolü” sağlanabilmektedir. Ayrıca bu teşvikler ile hükümet sadece inovasyonu teşvik etmekle kalmıyor, aynı zamanda bağımsız Ar-Ge sürecinde geliştirilen teknolojileri ve bilgileri kamu kesimine aktarmayı hedeflemektedirler (Lichtenberg, 1995: 441).

2.2. Türkiye’de Savunma Sanayinin Teşvikler Açısından Değerlendirilmesi

Gerek parasal teşvikler gerekse vergi teşvikleri tüm alanlarda olduğu savunma sanayinin performansını etkileyen tek unsur değildir. Ancak yapılan birçok çalışmada teşviklerin önemli etkilerinin olduğu genel kabul görmüştür. Savunma sanayinin gelişimi için verilen teşviklerin değerlendirmesi bu sektöre yönelik bazı göstergeler doğrultusunda yapılabilir. Bu göstergeler; *sektördeki ihracat ve ithalat karşılaştırması ve Türk savunma sanayi şirketlerinin dünya piyasalarındaki yeridir.*

Ülkemizde savunma ve havacılık ihracatının gelişimi Şekil 2’de gösterilmektedir. 2000’li yıllarda savunma ve havacılık ihracatı genel olarak artmıştır. 2008 yılından 2016 yılına kadar istikrarlı artışın olduğu görülmektedir. Ancak 2017 yılında düşüş olduğu görülmektedir. Düşüşün yaşandığı dikkat çeken yıl 2020’dir. Bu yılda 2019 yılına göre % 16,8 oranında düşüş olmuştur. Bu düşüş 2019 Covid-19 salgını nedeniyle ülke kaynaklarının tahsisinde önceliğin değişmesinden dolayı savunma sektörüne ayrılan kaynağın azalmasından kaynaklanmaktadır (SASAD, 2020:11).

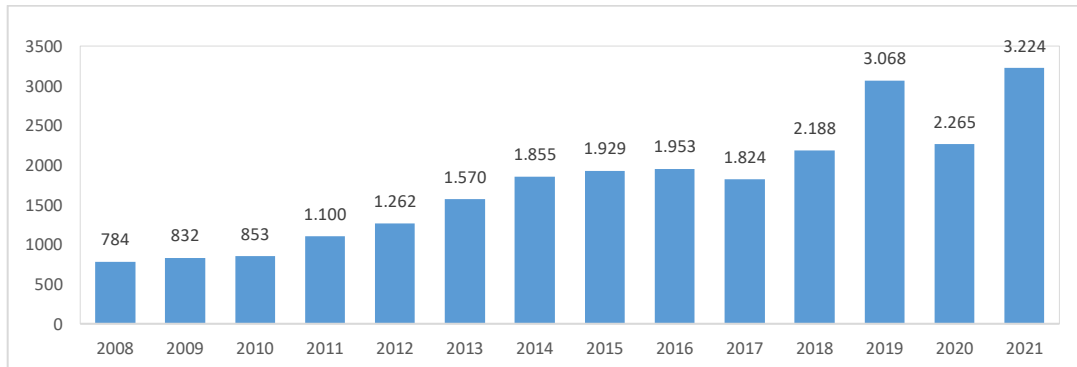

Şekil 2: Savunma ve Havacılık İhracatı (Milyon \$)

Şekil 3’de 2012- 2020 dönemi için savunma ve havacılık sektöründeki ithalat tutarları gösterilmektedir (SASAD, 2015 ve 2020). 2020 yılına gelindiğinde genel olarak artış bulunmaktadır.



Bunun istisnaları olan yıllar vardır. 2016 ve 2017 yılında sektörde yurtdışı girdi payının azaldığı görülmektedir. İthalatta da 2019 yılına göre 2020 yılında % 30 oranında düşme olmuştur. Bu düşüş de gizli ambargolar Covid-19 salgınının yarattığı üretim daralmasından kaynaklanmaktadır. İhracatın ithalatı karşılama oranı yaklaşık olarak başa baş şeklinde bir gelişim göstermektedir.

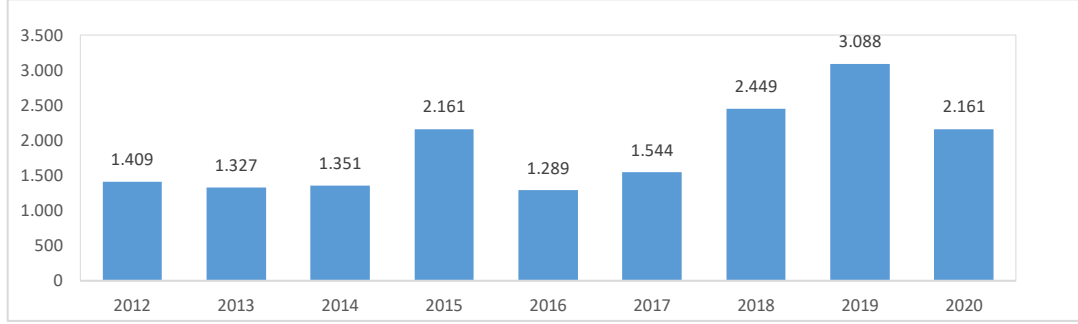

Şekil 3: Savunma ve Havacılık İthalatı (Milyon \$)

Tablo 1’de 2012 ve 2021 yılları arasında dünyadaki ilk 100’de yer alan Türk savunma şirketleri verilmektedir. Türk savunma şirketleri bu sıralama içindeki yeri yıllar itibariyle olumlu gelişme göstermiştir. Örneğin Aselsan 2012’de 76’ncı sırada iken, 2021’de 48’inci sıraya yükselmiştir. İlk 100’e giren şirket sayısı da artmıştır. Şirket sayısı 2018 ve 2019’da önemli ölçüde artmasına karşın 2020’de düşmüştür.

Tablo 1: Dünya Genelinde İlk 10’da Yer Alan Savunma Şirketleri (Milyon \$)

Yıl	Sıralamada ki Yer	Şirket	Bir önceki Yıl Savunma Geliri	İlgili Yıl Savunma Geliri	Savunma Geliri Değişimi %
2012	76	-Aselsan	848.400.00	862.365.671	1,6
	83	-Turkish Aerospace Industries	737,847,074	693,414,284	-6,0
2013	74	-Aselsan	862.4	1,001.40	16,10
	85	-Turkish Aerospace Industries	693.4	788.4	13,70
2014	67	-Aselsan	1,001.40	1,109.00	10,70
	80	-Turkish Aerospace Industries	788.40	853.60	8,30
2015	62	-Aselsan	1,109.00	1,025.98	-7,49
	78	-Turkish Aerospace Industries	853.60	886.55	3,86
2016	58	-Aselsan	1,025.98	1,195.28	17
	72	-Turkish Aerospace Industries	886.55	1,083.75	22
	99	-Roketsan	-	363.69	-
2017	57	-Aselsan	1,195.28	1,424.93	19
	61	-Turkish Aerospace Industries	1,083.75	1,089.63	1
	98	-Roketsan	363.69	376.08	3
2018	55	-Aselsan	1,424.93	1,792.63	26
	64	-Turkish Aerospace Industries	1,089.63	1,050.84	-4
	96	-Roketsan	376.08	522.76	39
	97	-Roketsan	369.96	564.83	53



INTERNATIONAL ASIAN CONGRESS ON CONTEMPORARY SCIENCES – VII

		-STM Savunma Teknolojile ri Mühendisli k ve Ticaret A.S.			
2019	52	-Aselsan	1,792.63	2,172.57	21
	69	-Turkish	1,050.84	1,858.35	42
	89	Aerospace	522.76	515.18	-1
	85	Industries	522.76	485.08	-14
	85	-Roketsan			
		-STM	564.83	533.56	-4
		Savunma			
	Teknolojile	554.18	374.94	2	
	ri	278.60	295.61	6	
		Mühendisli k ve Ticaret A.S.			
		-BMC			
		Otomotiv			
		Sanayi ve			
		Ticaret			
		A.S.			
		-FNSS			
		Savunma			
		Sistemleri			
		A.S.			
		Havelsan			
		A.S.			
2020	48	-Aselsan	2,172.57	2,218.33	2
	53	-Turkish	1,858.35	1,256.42	-32
		Aerospace			
		Industries			
2021	48	-Aselsan	2,218.33	2,250.39	1
	68	-Turkish	1,256.42	1,302.95	4
	86	Aerospace	572.29	814.16	42
		Industries			
		-Roketsan			

KAYNA K: DefenseNews, 2022. <https://people.defensenews.com/top-100/>

Dünya genelinde ilk 10'da yer alan şirketlere sahip ülkeler, 2021 yılında ABD (6 şirket), İngiltere (1 şirket) ve Çin (3 şirket)'dir. ABD'leri tüm yıllarda ilk sıralarda ve en fazla şirkete sahip ülkedir. ABD'de diğer alanlara özellikle Ar-Ge açısından savunmaya göre daha az kaynak ayırmaktadır. Diğer bir ifadeyle ABD savunma Ar-Ge'lerine en fazla kaynak ayıran ülkedir (Steinbock, 2014:4-5). 2000'li yıllarda yıllık toplam Ar-Ge harcamalarının yaklaşık üçte ikisini savunma Ar-Ge'si yapan firmalara tahsis etmiştir (Steinbock, 2014:4-5). Nitekim ABD'nin güçlü bir savunma sanayine sahip olmasına etkili bir şekilde katkıda bulunan önemli bir faktör, gelişen ulusal savunma gereksinimlerini karşılayan yenilikçi, en yeni ürün ve çözümlerin tasarımı, geliştirilmesi ve üretimi için özel firmaları kullanılması olduğu belirtilmektedir (Holtzman, Sylvia, and Ganz, 2018:1). Çin ise son yıllarda savunma Ar-Ge'lerine yaptığı yatırımların sonucu olarak önemli mesafe kaydeden ülke olmuştur.

SONUÇ

Ülkelerin bütçeleri içinde savunma harcamalarına ayırdıkları pay soğuk savaşın sonrası bir süre düşme eğilimi gösterse önemini koruyan temel hizmet konumundadır. Günümüzde savunma sanayinin savunma sanayinin gelişimde güvenlik dışında ekonomik kaygıların ön plana çıktığı söylenebilir. Savunma sanayi sektörü, sivil sektörden farklılıklar göstermektedir. Bu farklılıklar



içinde savunma ürünlerinin askeri faaliyetlerde farklı işlevleri yerine getirmesi, çoğunlukla ikame olanaklarının olmaması ve fiyatlamalarının performans maksimizasyonuna dayanması sayılabilir. Bu özellikleri gereği savunma sektörü klasik anlamda bir sektör olarak görülememektedir. Küreselleşme ve ileri teknolojinin etkilediği alanların başında savunma sanayi gelmektedir. Küreselleşme ile birlikte ülkeler açısından savunma sanayinde yerli ve yabancı savunma şirketi arasındaki ayrımın azaldığı görülmektedir. Bu durum birçok yönden ulusal hükümetler karşısında savunma şirketlerinin elini güçlendirmiştir. Küreselleşme, dünya genelinde bölgesel olarak sanayileşmeyi yaygınlaştırarak bölgelerin güçlenmesini ve bunun sonucunda hegemonya savaşlarına da yol açmıştır. Dolayısıyla soğuk savaş bitmiş gibi görünse de yeni bir boyut kazanmıştır. Modern savunma teknolojisi birçok ileri teknoloji içerir. Savunma alanındaki teknolojik gelişim yayılma etkisiyle sivil sektör üzerinde de olumlu dışsal etkiler yaratabilmektedir. Bu iki unsur günümüzde savunma teknolojisi politikalarının belirlenmesinde bazı kilit unsurların değişmesi sonucunu yaratmıştır. Bu unsurlar arasında; miktar olarak daha fazla silah veya ekipmana sahip olmak savunma gücünün göstergesi olmaktan çıkması, askeri alanda yabancı ekipman alımı ve yabancı şirketler sayısı artması, askeri yatırımların makroekonomik amaçları gerçekleştirmeye katkı sağlaması, inovasyon üretiminde değişimdir. Bu değişimler savunma sanayinin ekonomik politikasının önem kazanmasına yol açmıştır. Savunma harcamalarının ekonomi üzerindeki etkilerinin altında yatan temel gerekçe, savunma Ar-Ge ve teknoloji ve bunun sivil ekonomi üzerindeki etkileridir. Savunma sanayi, güvenlik yanında sağladığı ekonomi politikası gereği hükümetler tarafından desteklenen alanların başında gelmektedirler. Savunma alanında ülkelerin dışa bağımlılığını azaltma ve savunma ürünlerinin ihracatını artırmak üzere savunma sanayinin desteklenmesi amaçlanmaktadır. Her zaman savunma sanayileri devlet tarafından desteklenen alan olmakla birlikte ileri teknolojiye dayalı yeni Savunma sistemlerinin getirdiği analitik zorluklar Ar-Ge maliyetlerinin karşılanması açısından bu destekler çok daha önem kazanmıştır. Bu destekler; devlet bütçesinden parasal ödemeler şeklinde yapılan doğrudan teşvikler ve vergisel teşviklerden oluşmaktadır.

Türk savunma sektörü 1990'lara kadar yurtdışından doğrudan tedarik üzerine odaklanmıştır. Bu durum başka ülkelere bağımlılık doğurmuştur. Bu bağımlılıktan kurtulmak ve ithalat yükünü azaltmak üzere doğrudan yurtdışından tedarike devam edilmesine rağmen Türk sanayi sektörü, yabancı şirketlerle ortak üretim programlarına başlamıştır. Ülkemizde de savunma sanayii geliştirmek üzere proje destekleri şeklinde parasal teşvikler ve vergi teşvikleri uygulanmaktadır. Türk savunma sanayinin gelişiminde teşviklerin değerlendirmek üzere sektördeki ihracat ve ithalat karşılaştırması ve Türk savunma sanayi şirketlerinin dünya piyasalarındaki yerini gösteren göstergeler değerlendirilmiştir. Savunma sanayi ihracatı ve ithalatı genel olarak artmıştır. 2019 Covid salgınının hem ihracat hem de ithalatı kısıcı etkisi görülmektedir. İhracatın ithalatı karşılama oranı yaklaşık olarak başa baş şeklinde bir gelişim göstermektedir. Bu savunma sanayi adına olumlu bir gelişmeyi göstermektedir. Dünya genelinde İlk 100'e giren Türk savunma şirketlerinin sıralama içindeki yeri olumlu gelişme göstermiştir. İlk 100'e giren şirket sayısı 2018 ve 2019'da önemli ölçüde artmasına karşın 2020'de düşmüştür. Proje destekleri 2014'den 2019 yılına kadar istikrarlı bir artış göstermesine karşın 2020 yılında düşmüştür. Artış oranlarının da çok yüksek olmadığı söylenebilir. Bu göstergeler doğrultusunda Türk savunma sanayinde olumlu gelişim olmakla birlikte yeterli olmadığı, bu sanayinin ülke ekonomisine sağlayacağı katma değer dikkate alındığında teşviklerin özellikle proje desteklerinin artırılmasının gerektiği söylenebilir.

KAYNAKLAR

Barber, T. 2015. Meeting New Defense Analytic Challenges: An Industry Perspective, *Military Operations Research Society*, 48(4):75-78.
DefenseNews, 2022. Available at: <https://people.defensenews.com/top-100/> [27.11.2022]



- Dunne, J. P., Braddon, D. 2008. *Economic Impact of Military R & D*, Flemish Peace Institute.
- Ersöz, F., A. Karaman 2011. Development of Defence Capability from an Innovation Perspective: The Case of Turkey, *Journal of Economic Cooperation and Development*, 32(2):19-38.
- FitzGerald, B. and Saylor, K. 2014. *Creative Disruption: Technology, Strategy and the Future of the Global Defense Industry*, Center for a New American Security.
- Guay, T. R. 2007. *Globalization and Its Implications for the Defense Industrial Base*, Strategic Studies Institute, US Army War College.
- Holtzman, Y., Sylvia, S. and Ganz, M. 2018. A Tactical Approach to R&D Tax Credits for Defense Contractors, *Tax Management Memorandum*, 59(23): 1-7.
- Jan, C.-G. 2003. Policies for Developing Defense Technology in Newly Industrialised Countries: A Case Study of Taiwan, *Technology in Society*, 25: 351–368.
- Jan, C.-G. 2005. Defense Technology in Society: Lessons from Large Arms Importers, *Technology in Society*, 27: 181–197.
- Lichtenberg, F. R. 1995. Economics of Defense R&D, *Handbook of Defense Economics, Volume 1*, Ed. by K. Hartley and T Sandler, Elsevier Science B. V.
- Lifshitz, Y. 2003. Defense Industries, *The Economics of Producing Defense*, ed. Yaacov Lifshitz, New York: Kluwer Academic Publishers: 143-224.
- Poole, E. and Bernard, J.-T. May, 1992. 'Defence Innovation Stock and Total Factor Productivity', *The Canadian Journal of Economics / Revue canadienne d'Economique*, 25(2): 438-452.
- Rogerson, W. P. Autumn-1994. Economic Incentives and the Defense Procurement Process, *The Journal of Economic Perspectives*, 8(4): 65-90.
- SASAD, 2015. *2020 Performans Raporu*, Savunma ve Havacılık Sanayii İmalatçılar Derneği.
- SASAD, 2020. *2020 Performans Raporu*, Savunma ve Havacılık Sanayii İmalatçılar Derneği.
- Steinbock, D. 2014. *The Challenges for America's Defense Innovation*, The Information Technology & Innovation Foundation.
- Şişman, D. Haziran 2017. Küreselleşme, Kriz ve Savunma Sanayi, *Marmara Üniversitesi İktisadi ve İdari Bilimler Dergisi*, 39(1):223-237.



YENİ NESİL PROBİYOTİKLER

İlkay YILMAZ

Başkent Üniversitesi, Güzel Sanatlar Tasarım ve Mimarlık Fakültesi, Gastronomi ve Mutfak Sanatları Bölümü, 06790, Ankara, Türkiye

ORCID: <https://orcid.org/0000-0001-5938-3112>

Berrak DELIKANLI-KIYAK

Bursa Uludağ Üniversitesi, İznik Meslek Yüksek Okulu, Bursa-Türkiye

ORCID No: <https://orcid.org/0000-0001-8093-3369>

Özet

Bağırsak bakterilerinin sağlık üzerindeki rolü üzerine yapılan çalışmalar, son on yılda bilinen bakterilerin ötesine geçmiş ve çok dikkat çekmiştir. Yapılan birçok araştırma sonucunda bağırsak mikrobiyotasındaki geçirgenlik değişiklikleri, kolit, obezite/metabolik sendromlar, diyabet, karaciğer hastalıkları, kardiyovasküler hastalıklar gibi bağırsak içi ve dışı, kronik inflamasyonla ilişkili hastalıkların gelişimi ile mikrobiyotanın ilgili olduğu bulunmuştur. Geleneksel probiyotikler genellikle iyileştirici etkiler gösterirken, ortaya çıkan yeni nesil probiyotikler, yeni koruyucu ve tedavi edici araçlar olarak literatürde yer almaya başlamıştır.

Kültür metodlarının gelişmesi, yeni genom ve metagenom dizileme teknikleri, bakteri genomu modifiye etmede güçlü tekniklerin geliştirilmesi probiyotik araştırmalarında yeni bir çığır açmıştır. Mikrobiyota çalışmaları ilerledikçe, anaerobik ortamda gelişen bakterileri inceleme olanağı artmış ve tek bakteri suşları taranır ve izole edilir hale gelmiştir. Özellikle inflamasyonla ilişkili hastalıkların iyileştirilmesiyle olan ilişkilerini karakterize etmek açısından bu gelişmeler son derece önemlidir. Önceki yıllarda probiyotiklerin besin veya besin bileşeni olarak işlevleri üzerinde çalışmalar yoğunlaşmışken; günümüzde probiyotikler konusundaki çalışmalar daha çok terapötik işlevleri ve tıbbi amaçlı kullanımları alanlarına yönelmiştir. Son çalışmalar birçok potansiyel yeni nesil probiyotiği (YNP) ortaya çıkarmıştır. Bunlar arasında insülin direncini kontrol eden *Prevotella copri* ve *Christensenella minuta*, obezite ve insülin direncini tersine çeviren *Parabacteroides goldsteinii*, *Akkermansia muciniphila* ve *Bacteroides thetaiotaomicron*, fareleri bağırsak hastalıklarına karşı koruyan *Faecalibacterium prausnitzii* ve iltihabı azaltan ve antikanser etki gösteren *Bacteroides fragilis* sayılabilir. Çalışmalar özellikler *Akkermansia muciniphila* üzerine yoğunlaşmıştır. *Akkermansia muciniphila*, insan fekal örneğinden 2004 yılında izole edilen ve dikkatleri üzerine çeken gastrointestinal mikrobiyota üyelerinden biridir. Bilimsel çalışmalardan elde edilen sonuçlar, *Akkermansia muciniphila*'nın diyabet ve obezite gibi günümüzün önemli sağlık sorunlarına karşı alternatif bir çözüm olabileceğini düşündürmektedir. *Akkermansia*'nın bu etkisi, mütisini degrade edebilme yeteneği sayesinde mukus kalınlığını ve bağırsak bariyer bütünlüğünü pozitif şekilde modüle ederek metabolik endotoksemiye azaltmasından kaynaklanmaktadır. Bireylerin diyetlerinde yer alan gıdaların polifenol, probiyotik ve prebiyotik içeriklerinin de *Akkermansia* sayısı üzerine etkilerinin olduğu belirlenmiştir. Yakın gelecekte NGP'nin sağlık biyo-endüstrisinde kullanılmaya başlanması beklenmektedir. Bu çalışmada yeni nesil probiyotiklerin tanıtılması ve potansiyel etkilerine yönelik çalışmaların irdelenmesi amaçlanmıştır.

Anahtar Kelimeler: Probiyotikler, sağlık, mikrobiyota, bağırsak bakterileri, yeni nesil probiyotikler



NEXT GENERATION PROBIOTICS

Abstract

Studies on the role of gut bacteria in health have gone beyond the known bacteria in the past decade and have received much attention. As a result of many studies, it has been found that the microbiota is related to the permeability changes in the intestinal microbiota, the development of chronic inflammation- related diseases such as colitis, obesity / metabolic syndromes, diabetes, liver diseases, cardiovascular diseases. While traditional probiotics generally show curative effects, emerging next generation probiotics have started to take place in the literature as new preventive and therapeutic tools.

Culture methods, new genome and metagenome sequencing techniques, development of powerful techniques for modifying the bacterial genome broke new ground in probiotic research. As microbiota studies progress, the opportunity to examine bacteria growing in anaerobic conditions has increased and single bacterial strains have become screened and isolated. These developments are particularly important in characterizing their relationship to the cure of inflammation -related diseases. While studies have focused on the functions of probiotics as nutrients or nutritional components in previous years; Today, studies on probiotics are mostly focused on their therapeutic functions and medical uses. Recent studies have revealed many potential next-generation probiotics (NGP). These include *Prevotella copri* and *Christensenella minuta*, which controls insulin resistance, *Parabacteroides goldsteinii* reversing obesity and insulin resistance, *Akkermansia muciniphila* and *Bacteroides thetaiotaomicron*, *Faecalibacterium prausnitzii* that protects mice against intestinal disease and *Bacteroides fragilis*, which reduce inflammation and have anticancer effects. Studies have focused on *Akkermansia muciniphila*. *Akkermansia muciniphila* is a member of the gastrointestinal microbiota that was isolated from a human fecal sample in 2004 and attracted attention. The results obtained from scientific studies suggest that *Akkermansia muciniphila* may be an alternative solution to today's important health problems such as diabetes and obesity. This effect of *Akkermansia* is due to its ability to degrade mucin, reducing metabolic endotoxemia by positively modulating mucus thickness and intestinal barrier integrity. It has been determined that the polyphenol, probiotic and prebiotic contents of the foods in the diets of individuals have effects on the number of *Akkermansia*. NGP is expected to be used in the health bio -industry in the near future. In this study, it is aimed to introduce next generation probiotics and to examine the studies on their potential effects.

Keywords: Probiotics, health, microbiota, intestinal bacteria, next generation probiotics



COUPLE FIXED POINT RESULTS OF GERAGHTY TYPE IN ORDERED METRIC SPACE

Berna Top

Ferhan Şola Erduran

Gazi University, Faculty of Science, Department of Mathematics, Ankara, Turkey.

Abstract

In this study we give some couple fixed point results of Geraghty type via another function in ordered metric space.

Keywords: couple fixed point, Geraghty type, ordered metric

INTRODUCTION

Fixed point theory is one of the important study areas of mathematics with a wide range of applications. The Banach fixed point principle, which is famous for Banach' name, has been the focus of researchers and many studies have been done. Some of these studies contributed to the fixed-point theory by generalizing Banach contraction.

In 1973, Geraghty (1973) generalized the Banach contraction condition by replacing the Cauchy condition for convergence of a contraction iteration in a complete metric space with an equivalent functional condition.

In 2004, Ran and Reurings (2004) introduced partial order in metric spaces and provided some fixed point results in such spaces. After, Bhaskar and Lakshmikantham (2009) introduced the concept of couple fixed points for a given partially ordered metric spaces. There are a lot of researchers who have thought about coupled fixed points in different contractive situations (Cirić et al. 2012, Berinde 2011, Sedghi et al 2010, Altun and Şimşek 2010, Samet 2010)

In this study we give some couple fixed point results of Geraghty type via another function in ordered metric space.

1. MATERIALS AND METHODS

Definition 1.1. (Bhaskar and Lakshmikantham, 2009) Let (X, \preceq) be a partially ordered set and $F: X \times X \rightarrow X$. The mapping F is said to have the mixed monotone property if $F(x, y)$ is monotone non - decreasing in x and is monotone non - increasing in y , that is, for any $x, y \in X$, $x_1, x_2 \in X, x_1 \preceq x_2 \Rightarrow F(x_1, y) \preceq F(x_2, y)$ and $y_1, y_2 \in X, y_1 \preceq y_2 \Rightarrow F(x, y_1) \succeq F(x, y_2)$.

Definition 1.2. (Bhaskar and Lakshmikantham, 2009) An element $(x, y) \in X \times X$ is called a coupled fixed point of the mapping $F: X \times X \rightarrow X$ if $x = F(x, y)$ and $y = F(y, x)$.

The main results of Bhaskar and Lakshmikantham in [10] are the following coupled fixed point theorems

Theorem 1.3. (Bhaskar and Lakshmikantham, 2009) Let (X, \preceq) be a partially ordered set and suppose there exists a metric d on X such that (X, d) is a complete metric space. Let $F: X \times X \rightarrow X$ be a continuous mapping having the mixed monotone property on X . Assume that there exists a $k \in [0, 1)$ with



$$d(F(x, y), F(u, v)) \leq \frac{k}{2} [d(x, u) + d(y, v)], \quad \text{for each } x \succcurlyeq u, y \preccurlyeq v \quad (1.1)$$

If there exist $x_0, y_0 \in X$ such that $x_0 \preccurlyeq F(x_0, y_0)$ and $y_0 \succcurlyeq F(y_0, x_0)$ then there exist $x, y \in X$ such that $x = F(x, y)$ and $y = F(y, x)$.

Theorem 1.4. (Bhaskar and Lakshmikantham, 2009) Let (X, \preccurlyeq) be a partially ordered set and suppose there exists a metric d on X such that (X, d) is a complete metric space. Assume that X has the following property:

- (i) if a non-decreasing sequence $\{x_n\} \rightarrow x$, then $x_n \preccurlyeq x$ for all n ,
- (ii) if a non-increasing sequence $\{y_n\} \rightarrow y$, then $y \preccurlyeq y_n$ for all n .

Let $F: X \times X \rightarrow X$ be a mapping having the mixed monotone property on X . Assume that there exists a

$k \in [0, 1)$ with $d(F(x, y), F(u, v)) \leq \frac{k}{2} [d(x, u) + d(y, v)]$, for each for each $x \succcurlyeq u, y \preccurlyeq v$. If there exist $x_0, y_0 \in X$ such that $x_0 \preccurlyeq F(x_0, y_0)$ and $y_0 \succcurlyeq F(y_0, x_0)$ then there exist $x, y \in X$ such that $x = F(x, y)$ and $y = F(y, x)$.

Definition 1.5. (Van Luong et al., 2011) Let (X, d) be a metric space. A mapping $T: X \rightarrow X$ is said to be ICS if T is injective, continuous and has the property: for every sequence $\{x_n\}$ in X , if $\{Tx_n\}$ is convergent then $\{x_n\}$ is also convergent.

In (Van Luong et al., 2011) the authors generalized of the main results of Bhaskar and Lakshmikantham (2009).

Let Φ denote all functions $\varphi: [0, \infty) \rightarrow [0, \infty)$ which satisfy $\varphi(t) < t$ and $\lim_{r \rightarrow t^+} \varphi(r) < t$ for all $t > 0$.

Theorem 1.6. (Van Luong et al., 2011) Let (X, \preccurlyeq) be a partially ordered set and suppose there exists a metric d on X such that (X, d) is a complete metric space and $T: X \rightarrow X$ is an ICS mapping. Let $F: X \times X \rightarrow X$ be a mapping having the mixed monotone property on X such that there exist two elements $x_0, y_0 \in X$ with $x_0 \preccurlyeq F(x_0, y_0)$ and

$y_0 \succcurlyeq F(y_0, x_0)$. Suppose there exists $\varphi \in \Phi$ such that

$$d(TF(x, y), TF(u, v)) \leq \frac{1}{2} \varphi (d(Tx, Tu) + d(Ty, Ty)) \quad \text{for all } x, y, u, v \in X \quad (1.2)$$

with $x \succcurlyeq u$ and $y \preccurlyeq v$. Suppose either

- (a) F is continuous or
- (b) X has the following property:
 - (i) if a non-decreasing sequence $\{x_n\} \rightarrow x$, then $x_n \preccurlyeq x$ for all n ,
 - (ii) if a non-increasing sequence $\{y_n\} \rightarrow y$, then $y \preccurlyeq y_n$ for all n .



Then there exist $x, y \in X$ such that $x = F(x, y)$ and $y = F(y, x)$ that is F has a coupled fixed point in X .

Corollary 1.7. (Van Luong et al., 2011) Let (X, \preceq) be a partially ordered set and suppose there exists a metric d on X such that (X, d) is a complete metric space. Let $F: X \times X \rightarrow X$ be a mapping having the mixed monotone property on X such that there exist two elements $x_0, y_0 \in X$ with $x_0 \preceq F(x_0, y_0)$ and $y_0 \succeq F(y_0, x_0)$

Suppose there exists $\varphi \in \Phi$ such that $d(F(x, y), F(u, v)) \leq \frac{1}{2} \varphi(d(x, u) + d(y, v))$, for all $x, y, u, v \in X$ with $x \succeq u$ and $y \preceq v$. Suppose either

(a) F is continuous or

(b) X has the following property:

(i) if a non-decreasing sequence $\{x_n\} \rightarrow x$, then $x_n \preceq x$ for all n ,

(ii) if a non-increasing sequence $\{y_n\} \rightarrow y$, then $y \preceq y_n$ for all n .

Then there exist $x, y \in X$ such that $x = F(x, y)$ and $y = F(y, x)$ that is F has a coupled fixed point in X .

Corollary 1.8. (Van Luong et al., 2011) Let (X, \preceq) be a partially ordered set and suppose there exists a metric d on X such that (X, d) is a complete metric space and $T: X \rightarrow X$ is an ICS mapping. Let $F: X \times X \rightarrow X$ be a mapping having the mixed monotone property on X such that there exist two elements $x_0, y_0 \in X$ with $x_0 \preceq F(x_0, y_0)$ and $y_0 \succeq F(y_0, x_0)$. Suppose there exists $k \in [0, 1)$ with $d(TF(x, y), FT(u, v)) \leq \frac{k}{2} [d(Tx, Tu) + d(Ty, Tv)]$, for each for each $x \succeq u, y \preceq v$. Suppose either

(a) F is continuous or

(b) X has the following property:

(i) if a non-decreasing sequence $\{x_n\} \rightarrow x$, then $x_n \preceq x$ for all n ,

(ii) if a non-increasing sequence $\{y_n\} \rightarrow y$, then $y \preceq y_n$ for all n .

Then there exist $x, y \in X$ such that $x = F(x, y)$ and $y = F(y, x)$ that is F has a coupled fixed point in X .

In (Van Luong et al., 2011) the authors give a simple example which shows that if T is not an ICS mapping then the conclusion of **Theorem 1.6** fails.

Example 1.9. (Van Luong et al., 2011) Let X with the usual metric and the usual ordering.

Let $F: X \times X \rightarrow X$ be defined by $F(x, y) = 2x - y + 1$,

for all $x, y \in X$ then F has the mixed monotone property and F is continuous and there exist

$x_0 = 1, y_0 = 0$ such that $x_0 \leq F(x_0, y_0)$ and $y_0 \geq F(y_0, x_0)$.

Let $\varphi: [0, \infty) \rightarrow [0, \infty)$ be defined by $\varphi(t) = t/2$, for all $t \in [0, \infty)$ then $\varphi \in \Phi$.

Let $T: X \rightarrow X$ be defined by $T(x) = 1$, for all $x \in X$ then T is not an ICS mapping.



Obviously, the **condition (1.2)** holds. However, F has no coupled fixed point

2. MAIN RESULT

Fixed point theorems for mappings satisfying Geraghty-type contractive conditions are proved in the frame of ordered metric spaces, and metric-type spaces. Examples are given showing that these results are proper extensions of the existing ones. In [3] Geraghty given:

Let be (X, d) a complete ordered metric space, and $F: X \rightarrow X$ be a self-map. Suppose that there exists $\beta: (0, \infty) \rightarrow [0, 1)$ satisfying the condition

$$\beta(t_n) \rightarrow 1 \text{ implies } t_n \rightarrow 0.$$

If F satisfies the following inequality:

$$d(Fx, Fy) \leq \beta(d(x, y))d(x, y) \text{ for all } x, y \in X,$$

then F has a unique fixed point.

Let δ denote the set of all functions $\beta: (0, \infty) \rightarrow [0, 1)$ satisfying the condition $\beta(t_n) \rightarrow 1$ implies $t_n \rightarrow 0$.

Theorem 2.1. Let (X, \preceq, d) be a complete ordered metric space, $T: X \rightarrow X$ ICS mapping and $F: X \times X \rightarrow X$ be a mapping having the mixed monotone property on X such that there exist two elements $x_0, y_0 \in X$ with $x_0 \preceq F(x_0, y_0)$ and $y_0 \succeq F(y_0, x_0)$. Suppose that there exists $\beta \in \delta$ such that

$$d(TF(x, y), TF(u, v)) \leq \frac{\beta(d(Tx, Ty), (Tu, Tv))}{2} \cdot \frac{d((Tx, Ty), (Tu, Tv))}{2}$$

holds for all $x, y \in X$. Suppose either

(a) F is continuous or

(b) X has the following property:

(i) if a non-decreasing sequence $\{x_n\} \rightarrow x$, then $x_n \preceq x$ for all n ,

(ii) if a non-increasing sequence $\{y_n\} \rightarrow y$, then $y \preceq y_n$ for all n .

Then there exist $x, y \in X$ such that $x = F(x, y)$ and $y = F(y, x)$ that is F has a coupled fixed point in X .

Proof: By the condition of the theorem there exist $x_0, y_0 \in X$ such that $Tx_0 \leq TF(x_0, y_0)$ and $Ty_0 \geq TF(y_0, x_0)$

We define $x_1, y_1 \in X$ as $Tx_1 = TF(x_0, y_0)$ and $Ty_1 = TF(y_0, x_0)$. Then $Tx_1 \geq Tx_0$ and $Ty_1 \leq Ty_0$.

In the same way, using the mixed monotone property of F .

we define $Tx_2 = TF(x_1, y_1)$ and $Ty_2 = TF(y_1, x_1)$

Then $Tx_2 = TF(x_1, y_1) \geq TF(x_0, y_1) \geq F(x_0, y_0) = Tx_1$ and



$$Ty_2 = TF(y_1, x_1) \leq TF(y_1, x_0) \leq TF(y_0, x_0) = Ty_1$$

Continuing the above procedure we have two sequences $\{x_n\}$ and $\{y_n\}$ in X such that

$$Tx_{n+1} = TF(x_n, y_n) \text{ and } Ty_{n+1} = TF(y_n, x_n) \text{ for all } n \geq 0.$$

Due to the mixed monotone property of F , we have,

$$Tx_0 \leq TF(x_0, y_0) = Tx_1 \leq TF(x_1, y_1) = Tx_2 \leq \dots \leq Tx_n = TF(x_{n-1}, y_{n-1}) \leq Tx_{n+1} \\ = TF(x_n, y_n) \quad (2.1)$$

and

$$Ty_0 \geq TF(y_0, x_0) = Ty_1 \geq TF(y_1, x_1) = Ty_2 \geq \dots \geq Ty_n = TF(y_{n-1}, x_{n-1}) \geq Ty_{n+1} \\ = TF(y_n, x_n) \quad (2.2)$$

From (2.1), (2.2), for all $n \geq 1$, it follows that

$$d(Tx_n, Tx_{n+1}) = d(TF(x_{n-1}, y_{n-1}), TF(x_n, y_n)) \\ \leq \beta(d(Tx_{n-1}, Tx_n) + d(Ty_{n-1}, Ty_n))(d(Tx_{n-1}, Tx_n) + d(Ty_{n-1}, Ty_n))$$

and

$$d(Ty_{n+1}, Ty_n) = d(TF(y_{n-1}, x_{n-1}), TF(y_n, x_n)) \\ \leq \beta(d(y_{n-1}, y_n) + d(x_{n-1}, x_n))(d(y_{n-1}, y_n) + d(x_{n-1}, x_n))$$

Let, for all $n \geq 0$, $a_n = d(Tx_n, Tx_{n+1})$, $b_n = d(Ty_n, Ty_{n+1})$ and

$$\delta_{n+1} = d(Tx_n, Tx_{n+1}) + d(Ty_n, Ty_{n+1}). \quad (2.3)$$

Then from the above two inequalities, for all $n \geq 1$,

$$\delta_{n+1} = d(Tx_{n+1}, Tx_n) + d(Ty_{n+1}, Ty_n) \\ \leq \beta(d(Ty_{n-1}, Ty_n) + d(Tx_{n-1}, Tx_n))(d(Ty_{n-1}, Ty_n) + d(Tx_{n-1}, Tx_n)) \\ \leq (d(Ty_{n-1}, Ty_n) + d(Tx_{n-1}, Tx_n))\delta_n \leq \delta_n \quad (2.4)$$

Therefore the sequence $\{\delta_n\}$ is a monotone decreasing sequence of non-negative real numbers.

$$\text{Hence there exists } \delta \geq 0, \text{ such that } \lim_{n \rightarrow \infty} \delta_n = \delta. \quad \text{Assume } \delta > 0 \quad (2.5)$$

$$\text{Then from (2.4) we have } \frac{\delta_{n+1}}{\delta_n} \leq \beta(d(Ty_{n-1}, Ty_n) + d(Tx_n, Tx_{n-1})) < 1 \quad (2.6)$$

Letting $n \rightarrow \infty$ in the above inequality, and using (2.6), we get



$\lim_{n \rightarrow \infty} \beta(d(Ty_{n-1}, Ty_n) + d(Tx_n, Tx_{n-1})) = 1$. By virtue of (1.1), this implies that

$$\lim_{n \rightarrow \infty} \{d(Tx_{n-1}, Tx_n) + (d(Ty_{n-1}, Ty_n))\} = \lim_{n \rightarrow \infty} \delta_n = 0$$

which is a contraction with (2.9). Hence $\lim_{n \rightarrow \infty} a_n = \lim_{n \rightarrow \infty} d(Tx_{n-1}, Tx_n) = 0$

$$\lim_{n \rightarrow \infty} b_n = \lim_{n \rightarrow \infty} d(Ty_{n-1}, Ty_n) = 0, \quad (2.7)$$

Next we show that $\{x_n\}$ and $\{y_n\}$ are Cauchy sequences.

If possible, let at least one of $\{x_n\}$ and $\{y_n\}$ be not a Cauchy sequence.

Then there exists $\varepsilon > 0$ and sequences of natural numbers $\{m(k)\}$ and $\{l(k)\}$ for which

$$m(k) > l(k) \geq k \text{ and such that for all } k \geq 1; \text{ either } d(Tx_{l(k)}, Tx_{m(k)}) \geq \varepsilon,$$

$$d(Ty_{l(k)}, Ty_{m(k)}) \geq \varepsilon \text{ Then for all } k \geq 1,$$

$$d_k = d(Tx_{l(k)}, Tx_{m(k)}) + d(Ty_{l(k)}, Ty_{m(k)}) \geq \varepsilon \quad (2.8)$$

Now corresponding to $l(k)$ we can choose $m(k)$ to be the smallest positive integer for which (2.8) holds. Then, for all $k \geq 1$, $d(Tx_{l(k)}, Tx_{m(k)-1}) + d(Ty_{l(k)}, Ty_{m(k)-1}) < \varepsilon$. (2.9)

Further from (2.1), (2.2), (2.7), (2.8) and (2.9), for all $k \geq 1$, we have

$$\begin{aligned} \varepsilon &\leq d_k = d(Tx_{l(k)}, Tx_{m(k)}) + d(Ty_{l(k)}, Ty_{m(k)}) \\ &\leq d(Tx_{l(k)}, Tx_{m(k)-1}) + d(Tx_{m(k)-1}, Tx_{m(k)}) + d(Ty_{l(k)}, Ty_{m(k)-1}) + d(Ty_{m(k)-1}, Ty_{m(k)}) \\ &= d(Tx_{l(k)}, Tx_{m(k)-1}) + d(Ty_{l(k)}, Ty_{m(k)-1}) + a_{m(k)-1} + b_{m(k)-1} < \varepsilon + a_{m(k)-1} + b_{m(k)-1} \end{aligned}$$

Taking the limit as $k \rightarrow \infty$ and using (2.6) we have $\lim_{n \rightarrow \infty} d_k = \varepsilon$

From (2.1), (2.2), (2.7), (2.8) and (2.9) for all $k \geq 1$, we obtain

$$\begin{aligned} d(Tx_{l(k)+1}, Tx_{m(k)+1}) &= d(TF(x_{l(k)}, y_{l(k)}), TF(x_{m(k)}, y_{m(k)})) \\ &\leq \beta(d(Tx_{l(k)}, Tx_{m(k)}) + d(Ty_{l(k)}, Ty_{m(k)})) (d(Tx_{l(k)}, Tx_{m(k)}) + d(Ty_{l(k)}, Ty_{m(k)})) \end{aligned}$$

Also from (2.1), (2.4), (2.5), and (2.6), for all $k \geq 0$, we have

$$\begin{aligned} d(Ty_{l(k)+1}, Ty_{m(k)+1}) &= d(TF(y_{l(k)}, x_{l(k)}), TF(y_{m(k)}, x_{m(k)})) \\ &\leq \beta(d(Ty_{l(k)}, Ty_{m(k)}) + d(Tx_{l(k)}, Tx_{m(k)})) (d(Ty_{l(k)}, Ty_{m(k)}) + d(Tx_{l(k)}, Tx_{m(k)})) \end{aligned}$$

Again, for all $k \geq 1$, we have



$$\begin{aligned}
d_k &= d(Tx_{l(k)}, Tx_{m(k)}) + d(Ty_{l(k)}, Ty_{m(k)}) \\
&\leq d(Tx_{l(k)}, Tx_{l(k)+1}) + d(Tx_{l(k)+1}, Tx_{m(k)+1}) + d(Tx_{m(k)+1}, Tx_{m(k)}) \\
&\quad + d(Ty_{l(k)}, Ty_{l(k)+1}) + d(Ty_{l(k)+1}, Ty_{m(k)+1}) + d(Ty_{m(k)+1}, Ty_{m(k)}) \\
&\leq d(Tx_{l(k)+1}, Tx_{m(k)+1}) + d(Ty_{l(k)+1}, Ty_{m(k)+1}) + d(Tx_{l(k)}, Tx_{l(k)+1}) + d(Tx_{m(k)+1}, Tx_{m(k)}) \\
&\quad + d(Ty_{l(k)}, Ty_{l(k)+1}) + d(Ty_{m(k)+1}, Ty_{m(k)}) \\
&\leq d(Tx_{l(k)+1}, Tx_{m(k)+1}) + d(Ty_{l(k)+1}, Ty_{m(k)+1}) \\
&\quad + d(Tx_{l(k)+1}, Tx_{l(k)}) + d(Tx_{l(k)}, Tx_{m(k)}) + d(Tx_{m(k)}, Tx_{m(k)+1}) \\
&\quad + d(Ty_{l(k)+1}, Ty_{l(k)}) + d(Ty_{l(k)}, Ty_{m(k)}) + d(Ty_{m(k)}, Ty_{m(k)+1}) \\
&\leq d_k + d(Tx_{l(k)+1}, Tx_{l(k)}) + d(Tx_{m(k)+1}, Tx_{m(k)}) + d(Ty_{l(k)+1}, Ty_{l(k)}) \\
&\quad + d(Ty_{m(k)}, Ty_{m(k)+1})
\end{aligned}$$

Taking the limit as $k \rightarrow \infty$ in the above two inequalities, using (2.6) and (2.9),

we have
$$\lim_{k \rightarrow \infty} \{d(Tx_{l(k)+1}, Tx_{m(k)+1}) + d(Ty_{l(k)+1}, Ty_{m(k)+1})\} = \varepsilon$$
 (2.10)

Adding (2.9), (2.10), and using the notation of (2.7), we have,

$$d(Tx_{l(k)+1}, Tx_{m(k)+1}) + d(Ty_{l(k)+1}, Ty_{m(k)+1}) \leq 2 \cdot \beta \left(\frac{d_k}{2}\right) \left(\frac{d_k}{2}\right) \leq d_k \quad (\text{since } \beta \in S)$$

Letting $k \rightarrow \infty$ in the above inequality, using (2.4) and (2.6) we obtain $\varepsilon \leq \lim_{k \rightarrow \infty} \beta \left(\frac{d_k}{2}\right) \cdot \varepsilon \leq \varepsilon$,

which implies $\lim_{k \rightarrow \infty} \beta \left(\frac{d_k}{2}\right) = 1$. $\beta \in S$, it follows that

$$\lim_{k \rightarrow \infty} d_k = \lim_{k \rightarrow \infty} \{d(Tx_{l(k)}, Tx_{m(k)}) + d(Ty_{l(k)}, Ty_{m(k)})\} = 0$$

Which by the virtue of (2.6), contradicts the fact that $\varepsilon > 0$

Therefore, $\{x_n\}$ and $\{y_n\}$ are Cauchy sequences in X and hence they are convergent in the complete metric space (X, d) .

Let
$$x_n \rightarrow x \text{ as } n \rightarrow \infty \quad (2.11)$$

$$y_n \rightarrow y \text{ as } n \rightarrow \infty \quad (2.12)$$

Next we prove that $Tx = TF(x, y)$ and $Ty = TF(y, x)$.



Let condition (a) holds, that is, F is continuous.

From (2.1), (2.11) and (2.12) we have respectively

$$Tx = \lim_{n \rightarrow \infty} Tx_{n+1} = TF\left(\lim_{n \rightarrow \infty} x_n, \lim_{n \rightarrow \infty} y_n\right) = TF(x, y)$$

$$Ty = \lim_{n \rightarrow \infty} Ty_{n+1} = TF\left(\lim_{n \rightarrow \infty} y_n, \lim_{n \rightarrow \infty} x_n\right) = TF(y, x)$$

Let condition (b) holds. From (2.1), (2.2), (2.11) and (2.12)

we have that $\{x_n\}$ is non-decreasing such that $x_n \rightarrow x$ and $\{y_n\}$ is non-increasing such that $y_n \rightarrow y$ as $n \rightarrow \infty$

Then by (2.2) and (2.3) we have, for all $n \geq 0$, $x_n \leq x$ and $y_n \geq y$. (2.13)

Then by (2.1), and using (2.13), for all $n \geq 0$, we have $d(TF(x, y), x_{n+1}) = d(TF(x, y), TF(x_n, y_n))$

$$\leq \beta(d(Tx, Tx_n) + d(Ty, Ty_n))(d(Tx, Tx_n) + d(Ty, Ty_n)) (d(Tx, Tx_n) + d(Ty, Ty_n)) \text{ (since } \beta \in S).$$

Taking $n \rightarrow \infty$ in the above inequality, and using (2.11)

we have $d(TF(x, y), x) = 0$, that is, $Tx = TF(x, y)$

Similarly, we have $Ty = TF(y, x)$.

Since T is injective mapping we have $x = F(x, y)$ and $y = F(y, x)$. This completes the proof.

CONCLUSION

The main contribution of this manuscript is to present couple fixed point of Geraghty type contraction mappings via another function in ordered metric spaces.

ACKNOWLEDGEMENT

The author is thankful to the learned referee for his/her deep observations & pertinent suggestions which helped us to improve the paper significantly.

REFERENCES

- Altun, I., & Simsek, H. (2010). Some fixed point theorems on ordered metric spaces and application. *Fixed Point Theory and Applications*, 2010, 1-17.
- Berinde, V. (2011). Generalized coupled fixed point theorems for mixed monotone mappings in partially ordered metric spaces. *Non. Anal.* 74, 7347–7355.
- Cirić, L., Olatinwo, M.O., Gopal, D., Akinbo, G. (2012). Coupled fixed point theorems for mappings satisfying a contractive condition of 'rational type on a partially ordered metric space. *Adv. Fixed Point Theory* 2, 1–8.
- Geraghty, M. A. (1973). On contractive mappings, *Proc. Am. Math. Soc.* 40(2), 604-608.
- Lakshmikantham, V.; Cirić, L. (2009). Coupled fixed point theorems for nonlinear contractions in



partially ordered metric spaces. *Nonl. Anal.* 70, 4341–4349.

Ran, A., & Reurings, M. (2004). A fixed-point theorem in partially ordered sets and some applications to matrix equations. *Proceedings of the American Mathematical Society*, 132(5), 1435-1443.

Samet, B. (2010). Coupled fixed point theorems for a generalized Meir-Keeler contraction in partially ordered metric spaces, *Nonlinear Anal.* 72 (12) 4508–4517.

Sedghi, S., Altun I., Shobe, N. (2010). Coupled fixed point theorems for contractions in fuzzy metric spaces, *Nonlinear Anal.* 72 (3–4), 1298–1304.

Van Luong, N., Thuan, N. X., and Hai, T. T. (2011). Coupled fixed point theorems in partially ordered metric spaces depended on another function. *Bulletin of Mathematical Analysis and Applications*, 3(3), 129-140.



SEÇİM SONRASI SİYASİ PARTİ DEĞİŞTİRMENİN DEMOKRASİ BAĞLAMINDA İNCELENMESİ

Hasan Yılmaz

İnönü Üniversitesi, İktisadi ve İdari Bilimler Fakültesi, Siyaset Bilimi ve Kamu Yönetimi Bölümü,
Malatya, Türkiye

Özet

Demokratik yönetim anlayışında egemenlik halka aittir. Demokrasilerin önemli bir parçası ve aracı olan siyasi partiler ise halkın egemenlik hakkını, halk için kullanmayı amaçlayan yapılardır. Demokratik süreçlerde planlanan seçimler ile halk, egemenlik hakkını mevcut siyasi partiye ve partinin belirlediği milletvekillerine teslim etmektedir. Milletvekillerinin seçim sonrası buldukları partiden ayrılarak başka bir siyasi parti kurmaları veya yasama organında grup oluşturamayan partilere geçerek parti grubu oluşturmaları tartışmaları beraberinde getirmektedir. Bu durumda seçmenin ideolojik veya başka bir amaçla oy verdiği siyasi partinin üyeleri, seçmenden aldığı yetkiyi kimi zaman parti ideolojisine aykırı da olsa farklı amaçlarla kullanabilmektedir. Bu çalışmada demokratik ilkeler bağlamında milletvekillerinin mevcut siyasi partilerinden ayrılarak yeni bir siyasal hareket oluşturması ve sonuçları konusu ele alınacaktır. Çalışmada betimleme yöntemi ile nitel araştırma teknikleri kullanılarak, mevcut kavram ve kuramlar üzerinden özgün bir değerlendirme yapılacak ve öneriler sunulacaktır.

Anahtar Kelimeler: Temsili Demokrasi, Milletvekili, Yasama, Siyasi Parti

EXAMINATION OF POLITICAL PARTY CHANGE AFTER ELECTION WITHIN THE CONTEXT OF DEMOCRACY

Abstract

In the understanding of democratic management, sovereignty belongs to the people. Political parties, which are an important part and tool of democracies, are structures that aim to use the sovereignty of the people for the people. With the elections planned in democratic processes, the people hand over their sovereignty to the current political party and to the deputies determined by the party. The fact that the deputies leave their party after the election and establish another political party or form a party group by moving to parties that cannot form a group in the legislature brings about discussions. In this case, the members of the political party to which the voters vote for ideological or other purposes may use the authority they receive from the voters for different purposes, even if they are against the party ideology. In this study, the issue of deputies leaving their existing political parties and forming a new political movement in the context of democratic principles and its results will be discussed. In the study, an original evaluation will be made on the existing concepts and theories by using the descriptive method and qualitative research techniques, and suggestions will be presented.

Keywords: Representative Democracy, Member of Parliament, Legislature, Political Party



GİRİŞ

Demokratik yönetim anlayışında egemenlik halka aittir. Halk, egemenlik hakkını yine demokratik yöntemler ile kullanmaktadır. Demokrasilerin önemli bir parçası ve aracı olan siyasi partiler ise halkın egemenlik hakkını, halk için kullanmayı amaçlayan yapılardır. Demokratik süreçlerde planlanan seçimler ile halk, egemenlik hakkını mevcut siyasi partiye ve partinin belirlediği milletvekillerine teslim etmektedir. Milletvekillerinin seçim sonrası buldukları partiden ayrılarak başka bir siyasi parti kurmaları veya yasama organında grup oluşturamayan partilere geçerek parti grubu oluşturmaları tartışmaları beraberinde getirebilmektedir. Bu durumda seçmenin ideolojik veya başka bir amaçla oy verdiği siyasi partinin üyeleri, seçmenden aldığı yetkiyi kimi zaman parti ideolojisine aykırı da olsa farklı amaçlarla kullanabilmektedir. Bu çalışmada demokratik ilkeler bağlamında milletvekillerinin mevcut siyasi partilerinden ayrılarak yeni bir siyasal hareket oluşturması ve sonuçları konusu ele alınacaktır. Çalışmada betimleme yöntemi ile nitel araştırma teknikleri kullanılarak, mevcut kavram ve kuramlar üzerinden özgün bir değerlendirme yapılacak ve öneriler sunulacaktır.

DEMOKRASİ ve SİYASİ PARTİLER

Demokrasi kavramı “halkın kendi kendisini kendi adına yönetmesi” şeklinde tanımlanmaktadır. Demokrasi kelime olarak ise “demos” ile “egemenlik-iktidar” anlamına gelen “kratos” kelimelerinin birleşmesinden oluşur (Tunç, 2008: 1115). Böylece demokratik yönetim halkın ön planda olduğu ve halkın kendi adına yönetsel kararlar aldığı bir yönetim şeklidir. Halkın nasıl yönetilmesi gerektiği konusu günümüzde de tartışılan ve muhtemelen tartışılmaya devam edecek konuların başında gelmektedir. Tarihsel sürece bakıldığında birçok düşünür ve yazar demokrasi hakkında görüşlerini açıklamıştır.

Aristo demokrasi kavramını kısa ve öz olarak ele alırken, halkın egemen olduğu yerde demokrasi, azlığın egemen olduğu yerde de oligarşinin hayat bulduğunu ifade etmiştir. Ancak ona göre, sayısal ifadelerin dışında, özgürlüğün egemen olduğu yerler anayasal bir demokrasi olarak kabul edilmektedir (Aristoteles, 1993: 113). Aristo’ya göre demokrasi halk meclisinde ve halkın temsilci gönderdiği alanlarda (yönetim erkinde) halk için halk iktidarı olarak kararlar almaktır.

Demokratik devlet anlayışına göre egemenlik halka, millete aittir. Halk bu egemenliği demokratik yöntemler ile kullanmaya çalışmaktadır. Farklı devlet sistemleri ve yapılarının olması nedeniyle, halk farklı şekillerde demokratik hakkını kullanabilme yetkisi edinmiş olur. Burada esas olan, seçimlerin demokratik yollarla yapılması, siyasi partilerin yine demokratik yöntemler ile iktidar yarışında var olmaları yine bu iktidar yarışının demokratik ve katılımcı bir şekilde sonuçlanması olarak kabul edilmektedir.

Demokrasi kavramında tek bir tanımdan söz etmek olası değildir. Sözcük olarak karşılığını bir tarafa bırakırsak, içerik olarak hukukun egemenliği, birtakım haklar ile özgürlükleri güvence altına alan, bütün vatandaşların katılabildiği seçimlerde sayısal çoğunluk ile seçimi kazanan temsilcilerin yönettiği anayasal bir kurumdur (Hobsbawm, 2008: 100).

Demokrasi egemenliğin kullanımı bakımından çeşitli sınıflara ayrılmaktadır. Sınıflandırmalar arasında en sık kullanılan ve çoğunlukla kabul edilen doğrudan demokrasi, yarı doğrudan demokrasi ve temsili demokrasidir. Doğrudan demokrasi, uygulanması en zor demokrasi türüdür. Çünkü halk demokrasiyi bizzat kendisi kullanmaktadır. İsviçre’nin bazı kantonlarında uygulanmaktadır. Yarı doğrudan demokrasi, egemenliğin kullanılmasının halk ile temsilcilerinin paylaştığı demokrasi çeşididir. Temsili demokrasi ise, halkın egemenliğini kullanması adına temsilcilerine yani parlamenterlere yetki vermesidir.

Siyaset, toplumun ortak bir hayatı paylaşabilmesi adına birtakım araçlara ihtiyaç duymaktadır.



Siyasetin kullandığı bu araçlar, yapılar veya sistemler siyasal açıdan ise iktidarı elde edebilmek adına kurgulanmış bir süreçtir. Bu sürecin sonucunda yöneten ve yönetilen ilişkileri ortaya çıkmaktadır. Yöneten iktidar ile yönetilen halk arasında güçlü bir bağ kurulması ve adil bir yönetim sağlanabilmesi için yöneten-yönetilen ilişkisinin araçları modern dönemde demokratik temeller üzerine kurulmaktadır. Bu bağlamda söz konusu ilişkiyi kurgulayacak en önemli araç siyasi partiler olmaktadır. Siyasi partiler, demokrasilerin en önemli araçlarından biri olarak iktidar mücadelesinde halkın temsiliyet zeminini oluşturmaktadır.

Temsili demokrasilerde egemenlik gücü halkın kendisindedir. Ancak halk kendisini yönetebilmek için, temsilcilerini seçerek parlamentoya göndermektedir. Halk temsilcilerini seçerken onlara birtakım egemenlik hakkını devretmektedir. Devredilen bu yetkilerle seçilen temsilciler yani milletvekilleri meclis çatısı altında bir araya gelerek yasama gücünü oluştururlar (Arslan, 2004: 40-41). Mecliste millet adına kanun yapma yetkisini kullanmaktadırlar.

Demokrasi egemenliğin kullanımı bakımından çeşitli sınıflara ayrılmaktadır. Sınıflandırmalar arasında en sık kullanılan ve çoğunlukla kabul edilen doğrudan demokrasi, yarı doğrudan demokrasi ve temsili demokrasidir. Doğrudan demokrasi, uygulanması en zor demokrasi türüdür. Çünkü halk demokrasiyi bizzat kendisi kullanmaktadır. İsviçre'nin bazı kantonlarında uygulanmaktadır. Yarı doğrudan demokrasi, egemenliğin kullanılmasının halk ile temsilcilerinin paylaştığı demokrasi çeşididir. Temsili demokrasi ise, halkın egemenliğini kullanması adına temsilcilerine yani parlamenterlere yetki vermesidir.

Demokrasilerde kuvvetlerin farklı görevleri vardır. Yürütme, yargı ve yasama ile birlikte, kuvvetler ayrılığı ilkesine dayanan demokrasilerde her bir kuvvetin Anayasa ve yasalarda sınırları ve sorumlulukları belirlenmiştir. Milletvekilleri halk tarafından demokratik yöntemlerle seçilerek parlamento veya benzeri bir çatı altında toplanmaktadır. Yasama vekillerin toplu halde kanun yaptıkları demokrasinin vazgeçilmez kurumudur. Yürütme ise yasamanın oluşturduğu kuralları uygulamaktan sorumludur. Yargı ise kanunları hukuka uygun olarak uygulamak görevini üstlenmiştir.

MİLLETVEKİLLERİNİN PARTİ DEĞİŞTİRMESİ

Günümüzde siyasal partide yer alan adayların seçmenlerden oy istedikten sonra seçim sonucuna göre partisini değiştirmesi, seçmen nezdinde soru işaretleri oluşturmaktadır. Temsili demokrasinin ana vurgusu temsiliyet anlayışına zıt olacak şekilde TBMM'de sandalye sayısını artırmak veya grup kurabilme şansını yakalamak adına siyasi partiler tüm bu soru işaretlerine rağmen vekil değişimi yapabilmektedir.

Türkiye'de 1977 genel seçimlerinde CHP 213 milletvekili çıkararak birinci parti olmuştu ancak tek başına iktidar olamıyordu. İkinci parti olan Adalet Partisi 189 milletvekiline sahipti (YSK, 2022). Bu durumda Adalet Partisi lideri Süleyman Demirel, Milli Selamet Partisi ve Milliyetçi Hareket Partisi'nden oluşan İkinci Milliyetçi Cephe hükümeti kuruldu. CHP lideri Bülent Ecevit aynı yıl yapılan yerel seçimlerde güç kazanınca AP'de yer alan ve bağımsız olan 12 vekille görüşme sağladı. Türk siyasetinde “Güneş Motel” vakası olarak bilinen bu görüşmede bakanlık önerdiği vekillerin desteğini alarak gücünü artırdı. Aldığı destek ile gensoru vererek mevcut koalisyon hükümetinin devrilmesine sebep oldu (TRT, 2022). Türk siyasetinde parti değiştirme olayının dönüm noktası olan bu olay oldukça önemliydi. Çünkü siyasal partiler sandalye sayısını artıracak yeni bir yol bulmuştu.



Fotoğraf 1: Güneş Motel Olayı



Kaynak: NTV, 2022.

Fotoğraf 2: TBMM'de 15 vekilin dönüşüne dair basın açıklaması



Kaynak: Anadolu Ajansı, 2022.

Vekil değiştirme örneklerinden biri de Haziran 2018 seçimlerinden önce CHP'den İYİ Partiye geçen 15 vekildir. 22 Nisan 2018 tarihli TBMM Başkanlığına sunulan dilekçede CHP'li 15 vekil İYİ Partiye katılmıştır. Bu değişimi ifade eden dilekçe kamuoyu bilgisindedir ve söz konusu vekillerin fotoğrafı aşağıda yer almaktadır. Seçim sonrası 15 vekil tekrar eski partilerine geri dönmüştür. CHP Grup Başkanvekili Engin Özkoç ve Özgür Özel ile İYİ Parti Genel Sekreteri Aytun Çıray TBMM'de basın açıklaması düzenlemiştir. 15 milletvekilinin isimlerini sayarak başlayan Özkoç, "15'liler artık



yuvada, görevleri tamam. (Söz konusu adalet ise söz konusu demokrasi ise söz konusu güçlü bir Türkiye ise söz konusu vatan ise gerisi teferruattır) diyen 15 arkadaşımız görevlerini yaparak, gönül huzuruyla bugün partimize dönüyorlar." demiştir. Kutlu görev olarak nitelendirilen bu durumun seçimde karşılığı oldukça önemlidir. Siyasi partilerin tüzüklerinde belirtilen amaç ve hedeflerine uygun adaylar ile seçmenlerden oy istemektedir. Hiçbir amacı uymayan adaylar seçmenden nasıl kabul görebilir?

GENEL DEĞERLENDİRME

Yaşanan vekil değişimleri olayı sorgulandığında parti ve seçmen arasındaki samimi duygular ve temsiliyet mekanizmasında sorunlar oluşturacağı düşünülmektedir. Ayrıca yasal düzenlemelerin boşluklarından yararlanarak seçim öncesi veya sonrası parti değişimi ahlaki açıdan sorgulanmalıdır. Siyaseti dizayn ederken matematiksel hesaplar ile vekil değişimleri yerine daha ahlaki ve ilkeli bir siyaset gelecek dönemlerde toplumsal meşruiyet açısından önemli olacaktır.

Diğer bir açıdan özellikle medya araçlarında “Kiralık vekil” “Askıda vekil” gibi nitelendirmeler Milletvekilliği anlayışına uygun değildir. Milletin Meclisinde millet temsil eden kişilerin matematiksel hesaplar sonucu parti değiştirmesi sonrası “kiralık” gibi sıfatlar alması oldukça üzücü ve Kabul edilemeyecek bir durumdur. Bu sıfatları onaylamadığımı ve TBMM kurumsal kimliğine aykırı olduğu unutulmamalıdır.

Her ne kadar ittifakların varlığı sorgulansa da ittifaklar seçimden önce koalisyon anlamına geliyor ve seçmene seçim şansı tanıyor. Ancak seçim sonrası A partisinin milletvekilini diğer B partisine göndermek ve sonra geri almak seçmene saygısızlık olarak nitelendirilebilir.

Sonuç olarak eğer siyasette ahlak ve ilkeler değil de matematiksel hesaplar daha önemli ise seçim kanununda acilen değişiklik yapılmalı ve vekil değişimi yerine başka bir formül aranmalıdır. Örneğin seçim barajı düşürülmesi veya Hazine’den alınan yardımların yeniden düzenlenmesi gibi formüller bulunabilir.

KAYNAKÇA

- Anadolu Ajansı, 2022. İYİ Parti'ye katılan 15 milletvekili yeniden CHP'ye döndü. <https://www.aa.com.tr/tr/gunun-basliklari/iyi-partiye-katilan-15-milletvekili-yeniden-chpye-dondu/1141032> (7.12.2022).
- Aristoteles, 1993. *Politika*. (Çev. Mete Tuncay). İstanbul: Remzi Kitabevi.
- Arslan, R, 2004. *Türkiye'ye siyasi model*. Ankara: Seçkin Yayıncılık
- Hobsbawm, EJ, 2008. *Küreselleşme, demokrasi ve terörizm*. (Çev. Osman Akınhay). İstanbul: Agora Kitaplığı.
- NTV, 2022. Güneş Motel olayı nasıl yaşandı (1977). https://www.ntv.com.tr/turkiye/gunes-motel-olayi-nedir-nasil-yasandi,LsTUtfZ_mEGvtrS8zA3jDg
- TRT Haber, 2022. Güneş Motelde ne olmuştu. <https://www.trthaber.com/haber/gundem/gunes-motelde-ne-olmustu-361994.html> (7.12.2022).
- Tunç, H, 2008. Demokrasi türleri ve müzakereci demokrasi kavramı, *Gazi Üniversitesi Hukuk Fakültesi Dergisi*, Cilt XII, (1-2), 1113-1132.
- YSK, 2022. Genel Seçim Sonuçları. <https://www.ysk.gov.tr/tr/05-haziran-1977-xvi-donem-milletvekili-genel-secimi/80056>(7.12.2022)



ARCHAEOLOGICAL STUDY OF TOMIS POTTERY

Rodica-Mariana ION

Anca Irina GHEBOIANU

Sofia SLAMNOIU-TEODORESCU

ICECHIM, Research Group „Evaluation and conservation of cultural heritage”, Bucharest, Romania
Valahia University of Târgoviște, Doctoral School of Materials Engineering, Targoviste, Romania
Valahia University of Targoviste, ICSTM, Targoviste, Romania

Abstract

The ancient city of Tomis is an archaeological site located on the territory of Constanta municipality, which contains small area of temples, warehouses, public buildings, mosaic pavements, colonnades, streets and aqueducts, commercial squares, extinct art monuments, marble workshops, glassware and ceramics of the Roman imperial era (I-III century AD).

In this paper, elemental and phase analysis of the encrustation material on selected Tomis ceramic samples was performed. Non-destructive, high-resolution methods such as -WDXRF, m-XRD, m-Raman and the quasi-destructive m-ATR-FTIR were used to examine these small, thin ceramic parts. A disordered, probably heat-treated (X-ray amorphous) kaolinite together with quartz and feldspar proved to be the encrustation material. In addition to kaolinite and quartz, goethite was also identified in the yellow and pink-yellow encrusted decorations, while the red coloring turned out to be hematite. Traces of gypsum were also partially detected. The results obtained helped a color collection of the fingerprint from Tomis pottery.

Keywords: Tomis, ceramic, pottery, archaeometry, archaeology

Acknowledgements: This work was supported by a grant of the Ministry of Research, Innovation and Digitization, CCCDI - UEFISCDI, project number [PN-III-P2-2.1-PED-2021-3885](#), within PNCDI III”.



CONSIDERATION OF ENVIRONMENTAL PROTECTION ASPECTS AS A RESULT OF EU SUBSIDIES

Anita Soós

Hungarian University of Agricultural and Life Sciences, Doctoral School of Economics and Regional Sciences, Gödöllő, Hungary

Abstract

EU accession was a very important event for Hungary. Hungarian agriculture needs external support, as our country's resources are not sufficient for the sector. Help is also expected from the European Union in the coming years. An aspect of fundamental importance is environmentally friendly farming, which is one of the most important tools in the Union for nature protection. In addition, the preservation of the landscape is also a particularly important target area. Maintaining the direction of environmental and nature protection has a good effect on domestic farmers, as the workers in agriculture can be persuaded to farm nature-friendly, however, according to environmentalists, even more should be done for environmental protection and climate protection in agriculture. Farmers can continue to play an important role in environmentally friendly agriculture and the preservation of biodiversity in the future. It would be particularly important if they focused even more on environmental protection and sustainability than agricultural subsidies. Today, agriculture still shows a tendency to pollute the environment, which is evident in industrial-scale farming and animal husbandry. But with sufficient regulation and practice, agriculture would also provide the solution.

Keywords: environmental protection, Unio, aid, environmentally friendly management, sustainability

Introduction

The development of Hungarian agriculture cannot be supported only from domestic resources. State subsidies are not sufficient for the self-sustainability and development of the sector, the involvement of external sources is essential. Help for Hungary can also be expected from the Union in the coming years. The aspects of environmentally friendly management, which is one of the most important tools in terms of nature conservation in the European Union, must be treated as a priority area for developments (F.Márkus, Sz. Nagy, Cs. Nemes, J. Balogh 1997)

The application of environmental and nature conservation aspects in agriculture shows a good direction, as farmers can be encouraged to farm nature-friendly.

In addition to the main goals, even more should be done for environmental protection and climate protection (Á. Kengyel 2005)

Views on agri-environmental protection of EU accession

Hungary's natural features are very favorable for agriculture. Intensive agricultural production has a negative effect on the environment in different regions of the country, but in some regions it has a particularly harmful effect. The problems can be remedied by prioritizing nature conservation and social concerns, as well as by reallocating subsidies. The main goal is to preserve natural values and



biological diversity through the continuous maintenance of traditional land use, farming and management practices (K. Antal, M. Guba, H. Kovács 2004)

The goal of changing the global regulatory environment is to support economically efficient environmentally friendly agriculture. During the accession negotiations, Hungary must develop a clear strategy in order to achieve the above objectives (T. Horváth M 2004)

There are still landscapes in our country that have been preserved by traditional forms of farming. These were previously severely affected by large-scale, industrial production. At the same time, it is expected that large-scale agricultural production ceases in disadvantaged areas. These conditions together justify the introduction of a system that brings us closer to an environmentally friendly agricultural practice (already introduced in EU countries (J. Ángyán 2005).

Results

Accession to the European Union presented new challenges to Hungarian agriculture and Hungary's farming, rural society. As a result, the domestic support system was reformed. As a result, the model of multifunctional agriculture became dominant in the Common Agricultural Policy. In addition to all these, nowadays new social demands (e.g. rural landscape preservation) and environmental challenges (e.g. climate change) also affect agriculture. Thanks to these processes, the goal and instrument system of agricultural policy and the structure of agricultural production were transformed in Europe, and then also in Hungary. The role of agriculture in the rural economy and within rural societies has undergone a significant transformation (R. Becsky 2004)

The positive benefits of joining the EU can be seen in the field of agri-environmental protection. A significant change has taken place in the area of measures aimed at preserving biological diversity. The requirements, measures, and regulations all contributed to the conservation of natural resources, the reduction of the environmental burden resulting from agriculture, and the greater spread of environmentally friendly farming practices among farmers (Gy Nagy Sándor 2004)

Conclusions

Among the prescribed conditions, we find many conditions (e.g. "application of crop rotation", "preservation of landscape elements", etc.) that are difficult to apply due to regional differences. The reconciliation of these areas is present as a fact that promotes the spread and effective practical application of environmentally friendly agriculture it would help if the positive results of the measures reached the farmers through regulations, application of agricultural practices, proposals, publications, services and further training.

The maintenance of the state of natural resources could change in an even more favorable direction, the environmental burden of agriculture could further decrease, as a result, our country could fulfill its international commitments in the field of environmental protection even more effectively, and environmentally friendly farming would become more and more popular among farmers.



Bibliography

- 1.) Agricultural and Rural Development Operational Program 2003: Ministry of Agriculture and Rural Development, Budapest. www.fvm.hu
- 2.) Environmental protection issues and the feasibility of introducing the methods of sustainable agriculture. Analytical study (Márkus F., Sz. Nagy, Ed.: Nemes Cs., Balogh J.) Sustainable Development Committee 1997.
- 3.) Antal K., Guba M., Kovács H. (2004): The situation of the Hungarian agricultural economy on the threshold of EU membership, *Gazdálkodás*, issue 2, p. 1-14.
- 4.) Ángyán J. (2005): Agricultural environmental management and rural development, *Agrárium*, February 2005, p. 18-21.
- 5.) Róbert Becsky - Gabriella Izikné Hedri: Regional policy of the European Union, Hans Seidel Foundation, Budapest, 2004.
- 6.) Tamás M. Horváth: Administrative conditions of regional politics, MKI, 2004.
- 7.) Ákos Kengyel: Cohesion and financing, *European Mirror*, June 2005
- 8.) Gyula Sándor Nagy - Zoltán Trombitás (ed.): Key to successful EU tenders 2., EU Working Group, Budapest 2004.



**ASSESSING THE LEVEL OF SAFETY CLIMATE IN SCIENCE LABORATORIES IN
ENGINEERING UNIVERSITIES IN PAKISTAN**

Tufail Ahmed

University of Engineering and Technology, Taxila, Pakistan

Abstract

Developing and sustaining a rich safety culture and mature safety climate are important factors in achieving a safe environment with a low injury rate. Safety climate is generally used as an indication of the underlying safety culture. Several serious accidents around the world in university laboratories demonstrated the need for improvement in the safety of universities. In Pakistan, safety climate studies have been reported for industrial settings, however, university laboratory safety climate has not been focused. A safety climate survey of laboratories was conducted at six engineering universities. The questionnaire was administered to engineering laboratories. The result of this study provided an overall safety climate score of 3.62 ± 1.22 , on a scale of 1-5 with 5 indicating a very high perception of safety. The lowest-scored dimensions were perceived risk and emergency response. The result of experiencing incidents or accidents revealed that accidents are not uncommon in universities. MANOVA showed that safety climate scores were related to previous lab experience and safety training. Universities can improve the safety climate of their laboratories by paying attention to significant factors highlighted in this study

Keywords: Safety Culture; Engineering Laboratories; Safety Climate

INTRODUCTION

The most difficult thing about creating a positive safety culture is to win people's 'minds and hearts to the safety cause. Although, both mind and heart are not in control of an organization, but people must be persuaded that safety is important to the organization. This can only be achieved by consistency of the organization toward continually striving to improve and sustain the safety within the organization (Cooper, 2001). The sustainability-oriented process in an organization has become an important strategic objective during the past three decades. One of the dimensions of sustainability is the management of human resources, health and, safety at work and adaptation to change (Hajmohammad & Vachon, 2014). Sustainability and safety are the same things in conserving resources (Taubitz, 2010).

Occupational safety is essential to prevent a workplace from different injuries, ailments, fatalities and financial losses. Ignoring safety in a workplace can lead to unfavorable circumstances. Around the world, statistics about injuries or fatalities in the workplace are not hidden from us. Hence, a pragmatic approach is to pay attention and take proactive steps toward safety to protect all personnel from any undesirable incident. A mature safety climate and rich safety culture are two important factors in accomplishing a safe work environment (Bergh et al., 2013). One way for organizations to take proactive steps is to find out the perceptions and attitudes of people toward safety within the organization by conducting a safety climate survey. The survey can be helpful in identifying the shortcomings related to safety in an organization. After identification of problems organization should address and take corrective actions to show commitment toward safety

Personnel working in laboratories are surrounded by different forces including a competing



atmosphere between peers, reward structures, publishing novel findings, regulatory restrictions and cutting-edge technologies. Several times safety practices in engineering laboratories are forgotten or ignored by the workers. Issues relating to academic laboratories are the existence of acute and chronic risks during work making the workplace more unique. Often safety practices in universities are ignored by workers, researchers and administration (Simpson, 2015). The deficiency related to safety in academic laboratories has now received much importance for decades due to the introduction of new safety regulations. Despite much attention, the safety culture of laboratories is inadequately addressed as compared to industrial laboratories (McGarry et al., 2013). Conducting safety surveys and risk assessments contributes in improving research activities (Oshima, 2016). Different information from hazard exposures, injury and event investigations, internal and external audits, emergency issues and inspections are collected to identify the associated risks. The potential impact of the risk is then evaluated to manage environmental health and safety aspects. Chemical, physical, health, ergonomics, electric and mechanical hazards and other associated risks are the most prominent threat to a worker's health in a laboratory environment (Ozdemir et al., 2017). Occupational injuries and illnesses can have major impacts on the affected employee. Hazard and injuries cost so much for employees as well as employers. It would be beneficial for management to clearly understand the direct and indirect effects of health hazards on costs (Galizzi & Zagorsky, 2009). University and college laboratories may possess hazards such as chemical, biological, physical and radiological agents. Hazards associated with small art colleges are usually limited to or associated with fires and physical safety issues such as slips, trips, falls, food sanitation and communal housing problems, and small chemical inventories maintained for teaching laboratories and art shops. Institutions offering programs in sciences, such as biology, chemistry, engineering, pharmacy, agriculture, medicine, and veterinary medicine, can be worksites with many diverse and severe hazards (Gutiérrez et al., 2013) When it comes to organizations delivering services to the public, they must execute their tasks in a safe environment without harming or cost to clients. Engineering universities are primarily designed to develop proficiency and technical skills and to provide opportunities for the practical application of theories with critical thinking. The experiences gained from laboratories help to nourish skills and promote inquiry-based learning.

The primary purpose of assessing the safety climate in organizations is to utilize the data to find out the probability of accidents or incidents and to establish some proactive measures for a safe work environment. In order to improve the occupational safety climate level, it is necessary to find out the level of the current safety climate and decide what would be the level of safety and organize a plan to achieve the desired safety level. Therefore, a tool to measure the safety climate and level of safety would be valuable to the health, safety and environment of an organization

Safety climate Concept: The term Safety climate was first used by Zohar, 1980 and defined as “shared perceptions with regard to safety policies, procedures and practices” in an organization. Safety climate is an important phenomenon that describes the relationship between psychological processes with safety. Safety climate is interconnected with perceptions, attitudes, behaviors and their beliefs about safety (Cooper, 2001; Vu & Cieri, 2015; T. C. Wu et al., 2007). The existing safety climate influences the outcomes of safety improvements and represents how safety is valued in an organization.

The dictionary of psychology defines perception as the awareness of external objects, qualities or events in which the individual can interpret the stimulus and form an opinion about it. Safety climate is the perception made by employees about safety within the organization. Perception of safety refers to awareness, interpretation and opinion about some specific safety events, these opinions and beliefs shared by individuals develop safety climate (Kaczur, 2017). The safety outcomes such as accidents and injuries are related to the safety level of an organization (Nahrgang et al., 2011).



Safety Climate and Safety Culture: The debate between “Culture” or “climate” has been underway, that whether they represents the same or different concept (Ayi & Hon, 2018a; Gazica & Bowen, 2018; Kaczur, 2017; McGarry et al., 2013; Mearns & Flin, 1999; Soulat, 2017; Vu & Cieri, 2015; Zolandz & Gibson, 2013) However, most researchers used the two terminologies interchangeably. Mearns and Flin 1999 described the similarities and differences from previous findings. As, safety climate refers to a situation where it links to the thoughts, behaviors, attitudes and feelings of organizational members and it is a temporal measurement of current safety situations. While, safety culture represents the underlying beliefs, values and norms about safety among a group of people. (Mearns & Flin, 1999; Yule, 2008). Additionally, safety culture is more about the inner processes of how they perceive, think and feel about safety. Safety climate and culture are related in a way that safety climate may represent the past and future safety culture. The assessment of safety culture can be best with qualitative methods such as in-depth interviews while safety climate is often assessed via surveys (Lee et al., 2018). In fact, culture and climate assessment represent the significance of safety in an organization and both promote organizational safety (Griffin & Curcuruto, 2016a) However, safety climate is generally used as an indication of the underlying safety culture. (Mearns & Flin, 1999).

Organizational Climate: One of the most researched areas of organizational climates is safety climate. Organizational climate is a multidimensional construct surrounded by different dimensions in a work environment and these dimensions include leadership, communication, and roles. Specifying the dimensions, climate of safety and climate for customer services are subsets of organizational climate (Neal et al., 2000). Individual motivation to achieve work outcomes is greatly affected by organizational climate. A series of studies demonstrated that several factors have been identified as an important component of safety climate. The factors include management values, communications, and employee involvement. These factors predict safety related outcomes, such as accidents and incidents (Gutiérrez et al., 2013; Neal et al., 2000; T. C. Wu et al., 2007; Zohar, 1980). Additionally, employees work more effectively to achieve goals in a positive organizational climate rather than unhealthy climate (T. C. Wu et al., 2007).

Safety Climate Assessment: A Safety climate survey is typically measured using a questionnaire providing a snapshot of the current safety state (Gutiérrez et al., 2013). Responses from the survey are used to calculate safety level and strength for groups. The first stage of safety climate questionnaire is to identify the relevant theme for safety in organization. There are two methods for identifying the items, theoretical (normative) and pragmatic approach. In theoretical approach, the items are derived on the basis of theoretical model while in the pragmatic approach questionnaires are generated from previous research (Guldenmund, 2007). Most survey measures the safety climate using a Likert-type scale whereby respondents give reply with one option that ranges from strongly disagree to strongly agree The items are designed to assess the dimension and evaluate whether there are differences between groups on particular aspects of the safety climate (Bergman & Payne, 2018).

Features of Safety Climate: Two key features for describing safety climate are level and strength. The level for a group is the goodness and badness of safety climate and calculated as the average of individual safety climate score. On the basis of score, groups can be compared (Chan, 1998; Schneider et al., 2002). While strength shows the extent to which a group agrees on the level of safety climate. The strength can be measured within the group with variations and deviations. The standard deviation of responses shows the strength of safety climate when there is low variability there is greater agreement of perception among participants, thus climate is stronger (Bergman & Payne, 2018.). The strength measures the agreement of the group and shows the extent of group's score relevancy (Bergman & Payne, 2018). The high agreement shows that majority of members are on the same page regarding safety. On the other hand, safety climate level relates to safety outcomes (behavior, unsafe events), such as higher the safety climate better would be the outcomes.



Dimensions of Safety climate: Researchers have explored various dimensions of safety climate for a better understanding of the concept (T. C. Wu et al., 2007). In the study of employees of 20 industries, Zohar 1980 covered his study with eight dimensions and found two important dimensions in determining safety climate. A study by Flin et al. 2000 reviewed 18 safety climate questionnaires and identified six common dimensions: management/supervisor, safety systems, training/competence, risk, work pressure and policies/procedures. In educational institutions Wu et al., 2007 studied the impact of organizational and individual factors on five dimensions of safety climate. The dimensions included chief executive officer ‘safety commitment and actions, manager’s safety commitment, perceived risk, employee’s safety commitment and emergency response. The six dimensions identified by Kaczur 2017 in a study of engineering institute are; safety policies, safety communication, safety training, attitudes about instructor, attitude towards fellow students and one’s own safety attitudes. Despite of the diversity of dimensions in literature, different studies shown in *Table 1*, some core common themes including upper management commitment to safety, safety systems and procedures, training and competency related to safe working style (Griffin & Curcuruto, 2016).

Table 1 Summarized data of safety climate studies at universities

Name of Tools/ Author	Area	No of Questions	Number & Name of Dimensions
(T. C. Wu et al., 2007)	Universities and colleges of Taiwan	Total 46 Items. 12 items are general information	5 dimensions with demographic information. CEO’s Safety commitment and Actions Manager’s Safety commitment and Actions Employee’s Safety Commitment Perceived Risk Emergency Response
(Widyanti et al., 2008)	Universities of Indonesia	Used the tool developed by (T. C. Wu et al., 2007) 45 Items Questionnaire	5 dimensions. CEO’s Safety commitment and Actions Manager’s Safety commitment and Actions Employee’s Safety Commitment Perceived Risk Emergency Response
(T.-C. Wu et al., 2008)	4-Colleges and Universities of Taiwan	The tool developed by (T. C. Wu et al., 2007) is used. 46 items questionnaire	5 dimensions CEO’s Safety commitment and Actions Manager’s Safety commitment and Actions Employee’s Safety Commitment Perceived Risk Emergency Response
(Gutierrez, 2012)	5 universities of US.	23 items	5 dimensions with Individual factors Perceptions of Risk Management Employee’s Safety Commitment Department and Supervisor’s Commitment Acknowledgement of Safety Performance Administration’s Safety Commitment
(Simpson, 2015)	university research laboratories	36 questions related to organizational and group level safety climate	2 dimensions with demographic information Organizational level safety climate i.e., Top management Group level safety climate i.e., Laboratory Supervisor
(Keiser et al., 2015)	Laboratory safety climate questionnaire	Used the tool developed by Beus. 30 items questionnaire for general safety climate.	7 dimensions Management commitment to safety Safety communication Co-worker safety practices Safety training Safety involvement Safety rewards Safety equipment & Housekeeping



(Steward et al., 2016)	University laboratories	26 questions related to laboratory safety	3 dimensions with demographic Questions Perception of safety Commitment of direct supervision to Safety Upper management commitment to safety
Saskatchewan Safety Climate Questionnaire (Kaczur, 2017)	University of Saskatchewan (college of Engineering)	62 items Shortened version is 27 items	6 dimensions with demographics Safety policies and procedure Safety training Safety communication Attitudes of instructor and supervisor Students attitudes toward safety One own's safety attitude and behavior

Around the world number of accidents resulting in many severe injuries and fatalities have been reported from laboratories of developed countries like USA (Zolandz & Gibson, 2013). However, none of the incidents appear to have happened in universities of Pakistan. This is unusual as many have argued that academic laboratories are unique and unsafe due to the presence of acute and chronic risks (Langerman, 2009) (Ayi & Hon, 2018b). Additionally, safety climate is a leading indicator as it fosters before injuries occur. Thus, safety climate is linked with safe environment. In Pakistan, safety climate studies have been reported for industrial organizations while, to our knowledge, the safety climate survey of engineering laboratories in Pakistan is not focused. Therefore, this safety climate research was carried out to analyze the influence of individual factors (gender, accident experience and safety training) on four components of safety climate (Upper Management's safety commitment and action (UMSC), employee's safety commitment (ESC), perceived risk (PR) and emergency response (ER)) in engineering education laboratories and evaluation of researcher's awareness related to lab safety.

This study is intended to assess the null hypotheses as under:

H1: There is no distinction in opinion based on gender regarding safety climate.

H2: There is no distinction in opinion regarding safety climate between workers with different accident experiences.

H3: There is no distinction in opinion regarding safety climate between trained and untrained workers.

MATERIALS AND METHODS

This research study has adopted a safety climate questionnaire survey, developed by T.-C. Wu et al, 2007 to collect data. The survey questionnaire has been filled out from different universities of Pakistan. The questionnaire consists of two parts. The first part is general information, evaluating organizational factors and individual factors the second is the safety climate scale. The questionnaire consists of two parts. The first part is general information, evaluating organizational factors (i.e., size, safety manager, safety committee, and location) and individual factors (i.e., gender, age, job tenure, title, accident experience, safety training, and work site); the second was the "safety climate scale". The scale is used to measure the employee's perception of safety climate including upper management safety commitment and action (UMCA), employee's safety commitment (ESC), perceived risk (PR), emergency response (ER), safety awareness and situational reaction. The scale has 46 questions. Each question is a complete narrative statement. Based on their actual experience and feeling, respondents' rate each of the questions using a five-point Likert scale (from 1= strongly disagree, 2=disagree, 3= neutral, 4=agree, and 5 = strongly agree).

The survey was conducted in 6 universities located in the capital territory and Taxila region. These universities have been selected owing to the following facts: (1) there are 21 Pakistan Engineering Council (PEC) recognized universities located in Islamabad, the capital of Pakistan, and Rawalpindi region. (2) universities located in other region target mostly local students while these universities entertain students from entire country. Hence the perception of students towards safety would be from all over the country. This



survey questionnaire has been floated via personal visits to various science laboratories at different universities and degree awarding institutes. Approximately 200 people were contacted from the engineering departments of universities.

Responses collected from the survey questionnaire were analyzed using Statistical Package for Social Science (SPSS 20). A quantitative method of analysis was selected to examine the safety level. A scale reliability test was also conducted and multivariate analysis of variance MANOVA was used to find out if any combination of dependent variables varies with the independent variables. All the data were coded in excel and exported to SPSS.

RESULTS

Results show the distribution of factors in this study. These factors include duration with university, age, gender, position in university, use university lab, previous laboratory experience, accident or incident experience, ownership of university and receipt of laboratory safety training. *Table 2* shows that most of respondents were with the university for more than 1 year (59.50%). The largest age group was 20 or below years old with 49.50% of participants. The gender proportion was not the same with most of the participants being male. The half of participants were working as lab engineers or faculty members and often used university labs daily or weekly. The majority of participants working in universities had previous lab experience. Most of the respondents had never experienced an accident or incident related to the safety of the workplace in universities while 22% had experienced some accident. Moreover, 61% of the participants had never received lab safety training.

Table 2: Demographic characteristic of respondents

Characteristics	Frequency	Percentage
Duration with University		
1 year	119	59.5
2 years	15	7.5
3 years	30	15.0
More than 3 years	36	18.0
Age		
20 and below	99	49.5
20-25	49	24.5
26-29	47	23.5
30 or above	5	2.5
Gender		
Male	163	81.50
Female	37	18.50
Position in University		
Researcher/Student	120	60.0
Lab Supervisor	28	14.0
Lab Engineer/ Faculty Member	52	26.0
Use of laboratories		
Daily	65	32.50
Weekly	98	49.00
Monthly	17	8.50
Other	20	10.00
Laboratory environment experience		
Yes	139	69.50
No	61	30.50
Accident or Incident		
Yes	44	22.00
No	156	78.00
Lab Safety Training		
Yes	78	39.00
No	122	61.00
Total	200	100%



Description of Universities and Engineering Discipline

The names of six participating universities were replaced with UNI-1, UNI-2, UNI-3, UNI-4, UNI-5, UNI-6 in this study. The involvement of each university in this study is shown in pie chart in *Figure 1*. The contribution of participants from UNI-2 covered (20%) of this study. UNI-4 contributed with the frequency of 38 (19%), UNI-5 contributed 36 (18.2%). Total seven Engineering departments, Chemical (CHE), Civil (CE), Computer (CPEN), Electrical (EE), Environmental (ENE), Industrial (IE), and Mechanical (ME), participated in this survey

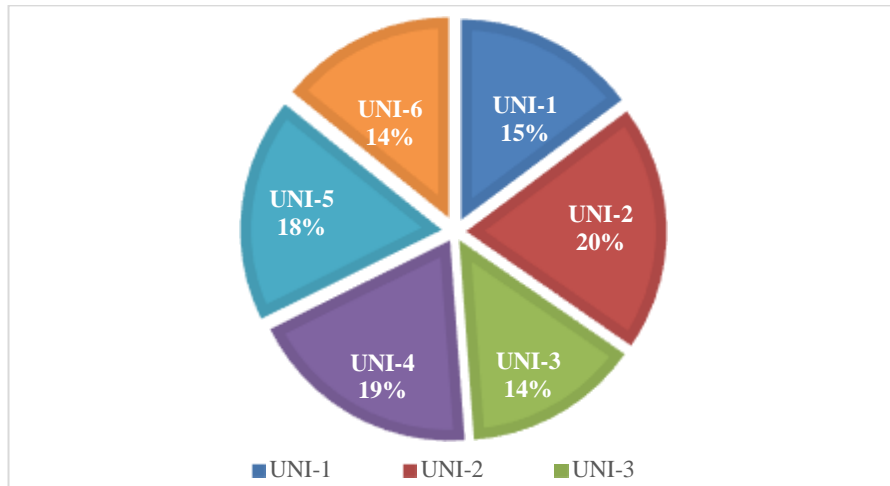

Figure 1 Contribution of universities

Safety Climate level in laboratories

A goal of this study was to obtain the safety climate and determine emergency response readiness. The dimensions were Upper Management’s Safety Commitment and Action (UMCA) with 7 items, Employee’s Safety commitment (ESC) with 6 items, Emergency Response (ER) with 8 items, Perceived Risk (PR) with 9 items. Lab Safety Awareness (LSA) with 17 items and Lab Situational Reactions (LSR) with 10 items were also analyzed. The questions used to assess the safety climate were categorized in six dimensions based on the type of questions related to specific areas. The last two dimensions (LSA and LSR) were assessed using frequencies of right and wrong answers. While for the first four dimensions (UMSCA, ESC, ER and PR) safety climate was measured by asking to select the ranked answer to the numerical values of safety climate questions. The combined overall safety climate for universities was 3.62 with the standard deviation of 1.22 on scale 1 to 5, where 5 indicates very high safety climate perception.

Table 3 shows the mean values with standard dimensions of safety climate. Results in table 3 showed the lowest scores on dimensions as “perceived risk” while highest perceived dimension was “Employ’s Safety Commitment”. This result shows a low level of uncertainty regarding the outcome of incident in lab. The highest perceived dimension ESC indicates good awareness about safety.

Table 3: Safety Climate level and standard deviation for four dimensions

Dimensions	Minimum	Maximum	Mean	Std. Deviation
UMCA	1	5	3.72	1.24
ESC	1	5	4.00	1.05
ER	1	5	3.59	1.24
PR	1	5	3.19	1.37
Overall Safety Climate Score	1	5	3.62	1.22



Normality reliability and Validity

A z-test was applied to test the normality of data using skewness and kurtosis. A z-value can be obtained by dividing the skewness value by their standard errors. (Doanne & Seward, 2011) A shapiro-wilk test and the visual inspection of their histogram are used to assess the normality of overall data. A combination of visual inspection (*Figure 2*) with the assessment of skewness and kurtosis, the data were within normal limits and may not need to transform.

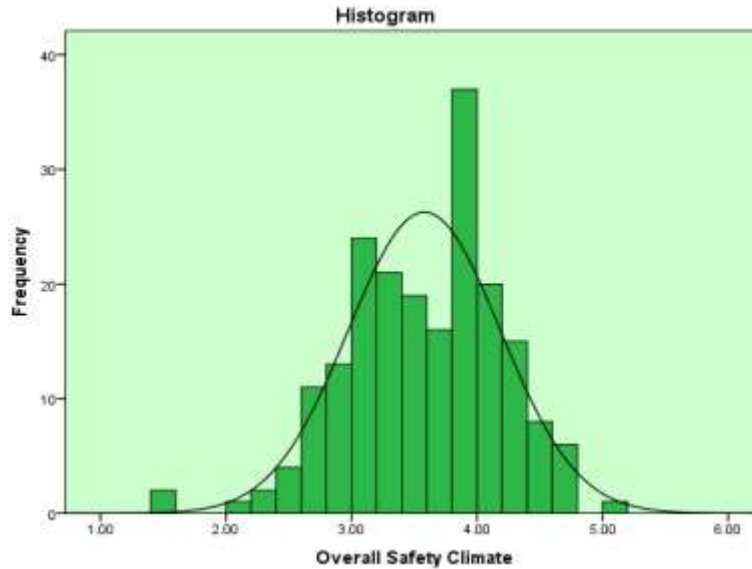

Figure 2: Data distribution of safety climate

To assess the internal consistency scale reliability was tested by Cronbach’s alpha for all safety climate dimensions and overall safety climate. The reliability of all four dimensions showed satisfactory internal consistency as they were above the standard guideline. The reliability of UMCA was high with a value of .905 and values of ESC, ER, and PR were .901, .892, .685 respectively. The reliability value for overall safety climate scale with 30 items was .862 as shown in *Table 4*.

Table 4: Reliability of safety climate scale

Dimensions	Cronbach’s Alpha	No of items	Test result
UMCA	.905	7	Reliable
ESC	.901	6	Reliable
ER	.892	8	Reliable
PR	.685	9	consider as Reliable
Overall Safety Climate	.862	30	Reliable

The correlation coefficient describes the linear dependencies between variables. Pearson correlation was used to perform to ensure the violation of assumptions. *Table 5* shows the positive correlations between the safety climate dimensions of UMCA, ESA and ER. There is strong positive correlation between overall safety climates with the dimensions.

Table 5 Validity of safety climate scale

Dimensions	1	2	3	4	5
UMCA	1				
ESC	.502**	1			
ER	.504**	.472**	1		
PR	.947	.665	.216	1	
Overall Safety Climate	.813**	.743**	.746**	.285**	1

** . Correlation is significant at the 0.01 level (2-tailed).

* . Correlation is significant at the 0.05 level (2-tailed).



Factors Affecting Safety Climate

In order to investigate the impact of independent variables on the safety climate subscale as dependent variables. One-way- multivariate analysis of variance (MANOVA) was used. Prior to conducting the MANOVA diagnostic test were conducted to ensure the suitability of MANOVA. Normality, linearity, and homogeneity of variance-covariance were conducted and found no serious violations (*Table 6*). The test was performed with 4 dependent variables UMCA, ESC, ER and PR. The independent variables were “duration with university”, “age”, “gender”, “position”, “use university lab”, “previous lab experience”, “accident experience”, “safety training”. The statistical test explains how independent demographic variables affect university laboratory safety climate dimensions. Data were analyzed using SPSS.

Table 6: Diagnostic tests for MANOVA and ANOVA

Factor	Box's M test		Levene's Test							
			UMCA		ESC		ER		PR	
	F	p	F	p	F	p	F	p	F	p
Duration with University	1.02	0.43	1.38	0.249	0.78	0.50	.361	0.781	1.34	0.26
Age	1.20	0.24	1.711	.166	2.046	.109	.946	.419	.068	.977
Gender	1.31	0.22	.613	.435	.067	.795	.252	.616	.509	.476
Position	1.27	0.18	.336	.715	1.079	.342	.676	.510	1.195	.305
Use University lab	1.53	0.05	.873	.456	1.539	.206	2.852	.039	2.803	.041
Previous Lab Experience	1.29	0.23	.028	.868	1.272	.261	.058	.809	.930	.336
Accident Experience	2.06	0.02	2.830	.094	3.750	.054	.308	.579	1.607	.206
Safety Training	2.74	0.05	.701	.403	.004	.952	5.644	.018	2.403	.123

Duration with University, Age, Position and Lab Work Experience

The independent variable “duration with university” had four levels, 1 year, 2 years, 3 years and more than 3 years with the university. *Table 6* shows the results of Box M test which was non-significant suggesting the assumption of variance covariance was not violated. Using Pillai's Trace value, the combined dependent variable was significantly not affected by the duration with university as independent variable (*Table 7*). The independent variable Age with four age groups, 20 or below, 20 to 25 years, 26-29 years and 30 or above was tested with four safety climate dimensions. Before conducting MANOVA variance-covariance was tested with Box M's value. The assumption was not violated as values are given table. Using Pillai's Trace value, the combined dependent variables are not significantly affected by age. However, with the multiple ANOVA the dimension ER reached statistical significance. Prior to ANOVA tests of homogeneity was conducted. Box M test was statistically non-significant for job position. Pillai's Trace criterion revealed that combined dependent variables were statistically non-significant. A one-way ANOVA also found that position did not relate to the safety climate dimensions. A question related to the use of university lab was asked to respondents with 4 levels, daily, weekly, monthly and others. Box M test was non-significant suggesting that the assumption of homogeneity of covariance was not violated. Results from Pillai's Trace criterion revealed that use of laboratory reached statistical significance affecting the combined dependent variables. However, by multiple one-way ANOVA did not find any relationship between subscales individually. A categorical independent factor of previous laboratory experience was asked to respondents. The prior tests did not violate the assumptions. MANOVA results showed that having previous laboratory experience significantly related to the combined dependent variables. Additionally, the ANOVA results showed that two dimensions, UMCA and ESC reached statistically significant. Thus, age of respondents', duration with university, use of lab and lab work experience have positive effects on the safety climate.

Gender: The independent categorical factor of Gender was analyzed with safety climate dimensions. A one-way MANOVA with dependent variables of safety climate dimensions and independent variables did not reveal multivariate effects for the categorical variable gender. Pillai's Trace value



of .043, $p=.487$ and $\eta^2=.06943$ was obtained as shown in *Table 7*. Results showed that Gender didn't reach statistical significance. ANOVA result also showed no statistically significant relationship between Gender and safety climate dimensions. Since *No significant difference exists for the safety climate between male and female employees*, thus H1 is accepted.

Accident Experience: The independent categorical factor of accident experience was analyzed with safety climate dimensions. Results showed that accident experience did not reach statistical significance. ANOVA results also showed no statistically significant relationship between accident experience and safety climate dimensions. Since *No significant difference exists for safety climate between employees with different accidental experiences*, thus H2 is accepted.

Safety Training: The receipt of safety training as an independent factor was analyzed. Diagnostic tests were performed the values were within acceptable limits. *Table 8* shows that lab safety training is significantly related to the combined safety climate dimensions. Multiple ANOVA tests also depicted that two dimensions UMCA and ER were reached significant levels. Further analysis illustrated that for both dimensions the participants with safety training perceived higher safety climate than those without safety training. Since *significant difference exists for safety training between employees*, thus H3 is rejected.

Table 7: Summary of factors affecting safety climate

Factors	Dimensions	MANOVA				ANOVA	
		Pillai's Trace	p	η^2	Power	F	P
Duration with university	UMCA	.036	.850	.012	.348	.174	.914
	ESC					.266	.850
	ER					1.051	.371
	PR					.298	.827
Age	UMCA	.084	.157	.028	.778	1.384	.249
	ESC					1.689	.171
	ER					3.948	.009*
	PR					.351	.788
Gender	UMCA	.023	.346	.023	.350	.206	.651
	ESC					.879	.350
	ER					3.716	.055
	PR					.184	.668
Position	UMCA	.049	.281	.025	.568	.254	.776
	ESC					.143	.867
	ER					2.172	.117
	PR					1.125	.327
Use University lab	UMCA	.061	.435	.020	.598	.905	.439
	ESC					.845	.471
	ER					1.405	.243
	PR					1.100	.350
Previous Lab experience	UMCA	.045	.029*	.054	.751	7.332	.007*
	ESC					5.438	.021*
	ER					8.476	.004*
	PR					.004	.949
Accident Experience	UMCA	.023	.344	.023	.351	1.763	.186
	ESC					1.684	.196
	ER					.002	.966
	PR					1.412	.236
Safety Training	UMCA	.133	.000*	.133	.997	3.213	.075
	ESC					1.671	.198
	ER					27.892	.000*
	PR					1.179	.279

Another dimension of this study was to investigate the awareness of the safety signs in scientific laboratories. For that purpose, this study was included in the questionnaire with a separate section. The questions in this section required the participants to match the correct name from given options. A list of seventeen safety signs was included with short descriptions with four options. Participants' responses were analyzed in this study. A correct answer indicated the participants could match the given safety signs with the right answer and were coded as 1 while an incorrect selection was coded



with 2.

The frequency and percentage of responses were calculated. The frequency and percentage of participant's responses, with correct, incorrect and no answers for 17 questions are presented in Table 8. The highlighted percentages indicated most participants' responses. This finding shows that most of respondents were aware of these safety signs.

Table 8: Frequency and percentage of participants' responses regarding safety awareness signs

Signs	Correct Answer		Incorrect Answer		No answer	
	F	(%)	F	(%)	F	(%)
Risk of danger	160	80	36	18	4	2
Explosive	80	40	57	58	4	2
Electric shock	94	47	102	51	4	2
Risk of fire	106	53	92	46	2	1
Moving parts can cuts	124	62	72	36	4	2
Heavy object	104	52	90	46	4	2
Hot surface	98	49	94	47	8	4
Low temperature	76	38	117	58.5	7	3.5
Don't touch	109	54.5	90	45	1	0.5
Fire Exit	96	48	100	50	4	2
No open Flames	133	66.5	64	32	3	1.5
Death danger: High voltage	88	44	109	54.5	3	1.5
Safety electrical connection don't Remove	102	51	92	46	6	3
No liquid near plug symbol	126	63	71	35.5	3	1.5
High voltage	93	46.5	103	51.5	4	2
Sharp edges watch your figure	116	58	81	40.5	3	1.5
Wear safety glasses	93	46.5	105	52.5	2	1



DISCUSSION

Assessment of Safety Climate

The aggregate mean of safety climate is 3.62 which is more towards “Agree”, which indicates a good perception of safety climate and it is nearly identical to the results presented by (T. C. Wu et al., 2007). Another research on same topic carried out by (Widyanti et al., 2008) found mean score of 3.5 which is also similar to the mean scores found in the current research. The intensity of the dimensions of safety climate found by survey analysis are as follows: ESC, UMCA, ER and PR. These intensities are devised depending upon the mean scores of all dimensions. The results show some similarity with those obtained by (T. C. Wu et al., 2007) on similar scale. Same results were also found by Widyanti (2008) who carried out research using the same safety climate scale. This shows that employees have better perception of their safety commitment and UMCA but weaker perceptions of emergency response and perceived risk. The low perceived dimensions show the lack of proper safety training in the institutions.

Individual Factors Impact on safety climate: Literature has identified various significant factors affecting safety climate which include: job tenure, job title, age, and experience (T. C. Wu & Li, 2006) Duration with university was found to be insignificant in current research. The age group of participants in this study was not significant and there was no relationship between the age group with the safety climate subscales. The result is associated with the findings of (Gutiérrez et al., 2013). However, contradictory to the findings of T. C. Wu et al., 2007 as they found a significant differences between employees of different ages. From the results, it is clear that there exists no distinction regarding safety climate perception on the basis of gender. These results contradict with the research presented by (Walters et al., 2017; T. C. Wu et al., 2007). According to T. C. Wu et al., 2007 males have a stronger perception than females while according to the research made by Walters et al., 2017 females are more willing to utilize safety practices when contrasted with males. However, current results favor the research presented by Kaczur, 2017; Widyanti et al., 2008 as far as perception is concerned.

Position, use of laboratory and accident experience were insignificant to the safety climate subscale in the current study. Previous laboratory experienced respondents have shown a stronger perception of safety climate in contrast to those who didn't experience any accident. Experience leads to paying more attention to a certain incident or matter and result is familiar with T. C. Wu et al., 2007 and (Widyanti et al., 2008). The risk perception of the individuals that have experience is higher that will allude to a greater probability of acting securely (Taylor & Snyder, 2017). Safety training has been a significant factor affecting the safety climate in universities. Safety training improves the safety behavior of employees which helps to promote positive safety climate It is proposed that employees become habitual working in safe environment when they are trained (Flin et al., 2000). The results are also consistent with the conclusions by T. C. Wu et al., 2007. Kaczur, 2017 also found a significant relationship between safety training and safety climate perception.

CONCLUSION

The research was conducted multi-pronged regarding the safety climate in science laboratories of Pakistan. One prong was to assess the safety climate, and the level of current safety. The safety climate questionnaires, derived from safety research studies after systematic assessment of tools, served as a valuable tool for safety climate studies at campuses. The goal to measure safety climate at universities based on this survey was achieved. The overall safety climate at universities' laboratories was 3.62 with a standard deviation of 1.22. The responses were collected on a scale of 1 to 5, with 5 indicating the highest perception of the safety climate. The lowest-rated subscales of safety climate were PR and ER. Hypothesis 1 and 2 are accepted (H1. No significant difference exists for safety climate between male and female employees. H2. No significant difference exists for safety climate between employees with different accidental experiences), while hypothesis 3 is



rejected (H3. No significant difference exists for safety training between employees). Results and comments of participants revealed that these low perceived dimensions are interlinked. This result suggests that the safety climate may be improved by bringing awareness and safety trainings. In this regards the role of higher management would be involvement in safety activities on the ground level and to ensure the implementation of formalized policies. A proper incident reporting system with top down effective safety communication for safety feedback may be useful in enhancing safety climate at campuses. Comments and results suggest that the commitment of direct supervision or trained instructors in laboratories can improve the attitudes of students toward safety.

Recommendations

Universities can improve the safety climate of their laboratories by paying attention to significant factors highlighted in this study. These factors are not only valid for the scenario of Pakistan in fact, but these factors are also global representatives for the improvement of safety climate. Based on the results, the following recommendations are proposed.

1. The management needs to improve the safety climate through their involvement in safety activities on the ground level and ensure the implementation of formalized policies.
2. It is also keen for higher management to improve safety communication for safety feedback with effective incident reporting to enhance a safety climate.
3. Higher management needs to ensure support of direct supervision's actions for implementing safer work practices in the laboratory.
4. More involvement and training of direct supervision can improve the safety climate of campuses.
5. Universities should conduct a periodical assessment of the safety climate to ensure that they have knowledge and understanding which influences the safety perception.
6. Laboratory management should develop and implement safe work practices through evaluation of workplace hazards, and periodic audits of safety activities and non-compliance.
7. Universities should pay attention to important factors affecting the safety climate. Improvement of actions based on these factors will facilitate creating a safe work environment.

REFERENCES

- Ayi, H. R., & Hon, C. Y. (2018a). Safety culture and safety compliance in academic laboratories: A Canadian perspective. *Journal of Chemical Health and Safety*, 25(6), 6–12.
<https://doi.org/10.1016/j.jchas.2018.05.002>
- Ayi, H. R., & Hon, C. Y. (2018b). Safety culture and safety compliance in academic laboratories: A Canadian perspective. *Journal of Chemical Health and Safety*, 1–7.
<https://doi.org/10.1016/j.jchas.2018.05.002>
- Bergh, M., Shahriari, M., & Kines, P. (2013). *Occupational Safety Climate and Shift Work*. 31, 403–408.
- Bergman, M. E., & Payne, S. C. (2018). Interdisciplinary collaborations facilitate safety climate research. *Journal of Loss Prevention in the Process Industries*, 56(August), 204–208.
<https://doi.org/10.1016/j.jlp.2018.08.007>
- Chan, D. (1998). Functional relations among constructs in the same content domain at different levels of analysis: A typology of composition models. *Journal of Applied Psychology*, 83(2), 234–246. <https://doi.org/10.1037/0021-9010.83.2.234>
- Cooper, D. (2001). *Improving safety Culture A practical Guide*. John Wiley & Sons Ltd.
- Doanne, D. ., & Seward, L. E. (2011). Measuring Skewness. *Journal of Statistics*, 19(2), 1–18.



- Flin, R., Mearns, K., O'Connor, P., & Bryden, R. (2000). Measuring safety climate: Identifying the common features. *Safety Science*, 34(1–3), 177–192. [https://doi.org/10.1016/S0925-7535\(00\)00012-6](https://doi.org/10.1016/S0925-7535(00)00012-6)
- Galizzi, M., & Zagorsky, J. L. (2009). How do on-the-job injuries and illnesses impact wealth? *Labour Economics*, 16(1), 26–36. <https://doi.org/10.1016/j.labeco.2008.02.003>
- Gazica, M. W., & Bowen, E. E. (2018). *Called to Safety? Individual and Combined Effects of Safety Climate and Occupational Callings on Aviator Safety Performance*. 28(1).
- Griffin, M., & Curcuruto, M. (2016a). Safety Climate in Organizations. *Ssrn*, July. <https://doi.org/10.1146/annurev-orgpsych-041015-062414>
- Griffin, M., & Curcuruto, M. (2016b). Safety Climate in Organizations. *Ssrn*, 191–214. <https://doi.org/10.1146/annurev-orgpsych-041015-062414>
- Guldenmund, F. W. (2007). The use of questionnaires in safety culture research - an evaluation. *Safety Science*, 45(6), 723–743. <https://doi.org/10.1016/j.ssci.2007.04.006>
- Gutierrez, J. M. (2012). A multi-site pilot test study to measure safety climate in the university work setting. *Dissertation Abstracts International Section A: Humanities and Social Sciences*, 72(11-A), 4219. <http://search.ebscohost.com/login.aspx?direct=true&db=psyh&AN=2012-99090-064&site=ehost-live>
- Gutiérrez, J. M., Emery, R. J., Whitehead, L. W., & Felknor, S. A. (2013). A means for measuring safety climate in the university work setting. *Journal of Chemical Health and Safety*, 20(6), 2–11. <https://doi.org/10.1016/j.jchas.2013.07.001>
- Hajmohammad, S., & Vachon, S. (2014). Safety Culture: A Catalyst for Sustainable Development. *Journal of Business Ethics*, 123(2), 263–281. <https://doi.org/10.1007/s10551-013-1813-0>
- Kaczur, M. B. (2017). *Culture and climate of safety in organizations: conceptualizations and assessment*. University of Saskatchewan.
- Keiser, N., Arthur, W., & Mannan, M. S. (2015). *An Empirical Test of Context-Specific Safety Climate Measurement: A Comparison of Five Research Laboratory Safety Climate Measures to a General Measure of Safety Climate*. August.
- Langerman, N. (2009). Lab-scale process safety management. *Journal of Chemical Health and Safety*, 16(4), 22–28. <https://doi.org/10.1016/j.jchas.2008.09.013>
- Lee, J., Huang, Y. H., Cheung, J. H., Chen, Z., & Shaw, W. S. (2018). A Systematic Review of the Safety Climate Intervention Literature: Past Trends and Future Directions. *Journal of Occupational Health Psychology*. <https://doi.org/10.1037/ocp0000113>
- McGarry, K. A., Hurley, K. R., Volp, K. A., Hill, I. M., Merritt, B. A., Peterson, K. L., Rudd, P. A., Erickson, N. C., Seiler, L. A., Gupta, P., Bates, F. S., & Tolman, W. B. (2013). Student involvement in improving the culture of safety in academic laboratories. *Journal of Chemical Education*, 90(11), 1414–1417. <https://doi.org/10.1021/ed400305e>
- Mearns, K. J., & Flin, R. (1999). Assessing the state of organizational safety—culture or climate? *Current Psychology*, 18(1), 5–17. <https://doi.org/10.1007/s12144-999-1013-3>
- Nahrgang, J. D., Morgeson, F. P., & Hofmann, D. A. (2011). Safety at Work: A Meta-Analytic Investigation of the Link Between Job Demands, Job Resources, Burnout, Engagement, and Safety Outcomes. *Journal of Applied Psychology*, 96(1), 71–94. <https://doi.org/10.1037/a0021484>
- Neal, A., Griffin, M. A., & Hart, P. M. (2000). The impact of organizational climate on safety climate and individual behavior. *Safety Science*, 34(1–3), 99–109. [https://doi.org/10.1016/S0925-7535\(00\)00008-4](https://doi.org/10.1016/S0925-7535(00)00008-4)
- Needs Assessment: Tools and Techniques*. (n.d.). 81–164.
- No Title*. (n.d.).
- Oshima, Y. (2016). *Characteristics of chemical risks in academic research laboratory*. 7(2), 95–97.
- Ozdemir, Y., Gul, M., & Celik, E. (2017). Assessment of occupational hazards and associated risks



- in fuzzy environment: A case study of a university chemical laboratory. *Human and Ecological Risk Assessment*, 23(4), 895–924. <https://doi.org/10.1080/10807039.2017.1292844>
- Schneider, B., Salvaggio, A. N., & Subirats, M. (2002). Climate strength: A new direction for climate research. *Journal of Applied Psychology*, 87(2), 220–229. <https://doi.org/10.1037/0021-9010.87.2.220>
- Simpson, S. A. (2015). *A study of safety climate and employees' trust of their organizational leadership in university research laboratories*. <http://lib.dr.iastate.edu/etd%0Ahttp://lib.dr.iastate.edu/etd/14487>
- Soulat, A. (2017). *Improvement of Safety Culture in Academic Laboratories of EPFL*.
- Steward, J. E., Wilson, V. L., & Wang, W. H. (2016). Evaluation of safety climate at a major public university. *Journal of Chemical Health and Safety*, 23(4), 4–12. <https://doi.org/10.1016/j.jchas.2015.10.016>
- Taubitz, M. (2010). How safety fits with sustainability. *Occupational Health & Safety (Waco, Tex.)*, 79(9), 18.
- Taylor, W. D., & Snyder, L. A. (2017). The influence of risk perception on safety: A laboratory study. *Safety Science*, 95, 116–124.
- Vu, T., & Cieri, H. (2015). *A review and evaluation of safety culture and safety climate measurement tools*. December. http://www.iscrr.com.au/__data/assets/pdf_file/0007/533581/060_REP_RES_R03-A-review-of-safety-culture-and-climate-tools.pdf
- Walters, A. U. C., Lawrence, W., & Jalsa, N. K. (2017). Chemical laboratory safety awareness, attitudes and practices of tertiary students. *Safety Science*, 96, 161–171. <https://doi.org/10.1016/j.ssci.2017.03.017>
- Widyanti, A., Manik Mahachandra, A. J., Satalaksana, I. Z., & Syaifullah, D. H. (2008). *Impact of Organizational and Individual Factors to Safety Climate At Universities in Indonesia (case study: West Java region)*. October, 22–24. www.SEAES2008.org
- Wu, T.-C., Li, C.-C., Chen, C.-H., & Shu, C.-M. (2008). Interaction effects of organizational and individual factors on safety leadership in college and university laboratories. *Journal of Loss Prevention in the Process Industries*, 21(3), 239–254. <https://doi.org/10.1016/j.jlp.2007.04.011>
- Wu, T. C., & Li, C. (2006). A multiple regression analysis on safety performance in university laboratories. *World Transactions on Engineering and Technology Education*, 5(3), 449–452.
- Wu, T. C., Liu, C. W., & Lu, M. C. (2007). Safety climate in university and college laboratories: Impact of organizational and individual factors. *Journal of Safety Research*, 38(1), 91–102. <https://doi.org/10.1016/j.jsr.2007.01.003>
- Yule, S. (2008). Safety culture and safety climate: A review of the literature. *Industrial Psychology Research Centre, 1980*, 1–18. Yule, S. (2003). Senior Management Influence on safety performance in the UK and US energy sectors. Doctoral thesis, University of Aberdeen, Scotland
- Zohar, D. (1980). Safety climate in industrial organizations: Theoretical and applied implications. *Journal of Applied Psychology*, 65(1), 96–102. <https://doi.org/10.1037/0021-9010.65.1.96>
- Zolandz, D., & Gibson, J. (2013). *Reveals Lab Risks*. 4–5.



**THE RESULTS OF 3D-CRT ALONE AND CONCURRENT WITH CHEMOTHERAPY IN
STAGE III NON-SMALL CELL LUNG CANCER**

Ulviyya Nabizade
Gunel Haci
Gulmira Nasirova
Isa Isayev

National Center of Oncology, Radiation Oncology department, Baku, Azerbaijan

Abstract

A retrospective analysis of 3-Dimensional Conformal Radiotherapy (3D-CRT) results of 110 primary patients with non-small cell lung cancer (NSCLC) stage III was provided at the National Center of Oncology. 89 (80.9%) of the patients were men, 21 (19.1%) were women, the average age was 69 (49-81) years.

Right lung cancer was diagnosed in 57 (51.8%) and left lung cancer in 53 (48.2%) patients. Central lung tumor was diagnosed in 79 (71.8%), peripheral-35 (31.8%), Pankost tumor in 4 (3.6%) patients. Stage IIIA was determined in 52 (47.3%), IIIB-46 (41.8%) and IIIC-12 (10.9%) patients during the examination. Pathomorphologically, 82 (74.5%) patients had squamous cell cancer, and 28 (25.5%) patients had adenocarcinoma. The general condition of patients according to the ECOG classification was determined in 96 (87.2%) grade 0-2, 14 (12.8%) grade 3-4 patients. 3DCRT with concurrent chemotherapy-chemoradiotherapy (CRT) was performed for 35 patients, and 3D-CRT alone for 75 patients. The fraction dose of radiation therapy was 1.8-2.0 Gy in 5 fractions per week, the total dose was 60.0-66.0 Gy and radiotherapy was provided by Varian Medical System Inc. (USA).

A month after the end of the treatment, the results were evaluated. Complete+partial regression of the pathological process was determined in 62 of 110 patients (56.3%). Progression was noted in 5 (4.5%) of patients. The patients with morphological squamous cell cancer, stage IIIA of the process, GTV volume less than 100 cm³, CRT, ECOG status 0-2, higher results were recorded compared to patients respectively with adenocarcinoma, stage IIIB-IIIC, GTV volume more than 100 cm³, independent RT, ECOG status 3-4 ($p \leq 0.05$). For patients with complete remission after treatment, all rates were higher during CRT compared to RT alone - 3-year survival rate was 21.3%, median survival was 16 (9-34) months ($p < 0.05$).

Conclusions: With concurrent chemoradiotherapy there was a reduction in risk of death compared to radiotherapy alone.

Keywords: 3-Dimensional Conformal Radiotherapy, lung cancer, chemoradiotherapy



CLINICAL, RADIOGRAPHIC, AND BIOCHEMICAL EVALUATION OF TWO-PIECE VERSUS ONE-PIECE SINGLE IMPLANTS WITH A LASER MICROGROOVED COLLAR SURFACE AFTER 5 YEARS OF FUNCTIONAL LOADING

Rodolfo Reda

Sapienza University of Rome, Faculty of Medicine and Dentistry, Department of Oral and Maxillo Facial Sciences, 00161 Rome, Italy.

ORCID ID: <https://orcid.org/0000-0003-1532-6524>

Alessio Zanza

Sapienza University of Rome, Faculty of Medicine and Dentistry, Department of Oral and Maxillo Facial Sciences, 00161 Rome, Italy.

ORCID ID: <https://orcid.org/0000-0002-2062-8140>

Dario Di Nardo

Sapienza University of Rome, Faculty of Medicine and Dentistry, Department of Oral and Maxillo Facial Sciences, 00161 Rome, Italy.

ORCID ID: <https://orcid.org/0000-0002-5054-0828>

Maurilio D'Angelo

Sapienza University of Rome, Faculty of Medicine and Dentistry, Department of Oral and Maxillo Facial Sciences, 00161 Rome, Italy.

ORCID ID: <https://orcid.org/0000-0002-4120-0717>

Luca Testarelli

Sapienza University of Rome, Faculty of Medicine and Dentistry, Department of Oral and Maxillo Facial Sciences, 00161 Rome, Italy.

ORCID ID: <https://orcid.org/0000-0003-3904-3000>

Abstract

To compare the clinical and radiographic conditions and the expression of proinflammatory cytokines in peri-implant crevicular fluid (PICF) at two-piece/bone level (TP/BL) versus one-piece/tissue level (OP/TL) single implants with a lasermicrogrooved collar after at least 5 years of loading.

In total, 20 single TP/BL implants and 20 contralateral OP/TL implants, both with a laser microgrooved collar surface, in 20 systemically and periodontally healthy subjects (12 males and 8 females, between the age of 36 and 64 [mean age of 49.7 ± 12.3 years]), were examined. Levels of IL-1 β , IL-1RA, IL-6, IL-8, IL-17, b-FGF, G-CSF, GM-CSF, IFN, MIP-1 β , TNF- α , and VEGF were assessed in PICF using the Bio-Plex 200 Suspension Array System. Plaque index (PI), probing depth (PD), bleeding on probing (BOP), and gingival recession (REC) were recorded. Radiographic crestal bone levels (CBL) were assessed at the mesial and distal aspects of the implant sites.

The mean PI, PD, BOP, and REC values had no significant differences in either group. A higher mean value of CBL with statistical difference was detected for TP/BL compared with OP/TL implants. The levels of IL-1 β , IL-6, IL-8, GM-CSF, and MIP-1 β and TNF- α were higher at TP/BL implants than at OP/TL implants. However, only IL-1 β , IL-6, and TNF- α values presented significant differences between the groups.



INTERNATIONAL ASIAN CONGRESS ON CONTEMPORARY SCIENCES – VII

Although after 5 years of loading single TP/BL and OP/TL implants with a laser microgrooved collar surface presented similar good clinical conditions, a higher proinflammatory state and higher crestal bone loss were detected for TP/BL implants.

Keywords: cytokines, dental implants, microgap/interface



YALIN ÜRETİM UYGULAMASININ ÖNÜNDEKİ ENGELLER: BIŞKEK ÖRNEĞİNDE

Gulnara KARADENİZ

Maksatbek ABDİCALİL UULU

Kırgızistan-Türkiye Manas Üniversitesi, Meslek Yüksekokulu, Bişkek, Kırgızistan.

Özet

Kaynak krizlerinin meydana geldiği günümüzde organizasyonlar, değişken ortamda hayatta kalmak ve başarılı olmak için verimli ve etkili yollar bulmak için daha fazla çaba gösterme gerçeğiyle karşı karşıyadırlar. Bu bağlamda, verimliliği, kaliteyi ve müşterilere hızlı yanıt vermeyi amaçlayan çeşitli uygulamalardan oluşan “Yalın üretime” ihtiyaç duyulmaktadır. Yalın üretim sisteminin uygulanması, organizasyonların tedarik sürelerini azaltmalarına, kaliteyi iyileştirmelerine, bu sayede yapabildiği zamanında teslimatlar ile müşteri memnuniyeti sağlamasına ve daha çok kâr sağlayan kaynaklara ulaşmalarına yardımcı olmaktadır.

Bu makalede, KOBİ'lerin yalın yolculuklarında karşılaştıkları zorluklar ve çalışanların yalın geçişe olan bakışlarına odaklanılarak tartışılmaktadır. Dolayısıyla, çalışmanın amacı, Bişkek'teki KOBİ'lerde yalın üretimin temel ilkelerinin ne ölçüde anlaşıldığı ve yalın üretim uygulama sürecini etkileyebilecek olası engelleri belirlemektir.

Keywords: Yalın üretim, 5S, Kaizen, KOBİ

OBSTACLES TO LEAN MANUFACTURING: IN THE CASE OF BISHKEK

Abstract

In today's time of resource crises, organizations face the reality of trying harder to find efficient and effective ways to survive and succeed in the volatile environment. In this context, there is a need for lean manufacturing, which consists of various applications aiming at efficiency, quality and quick response to customers. The implementation of the lean manufacturing system helps organizations reduce lead times, improve quality, ensure customer satisfaction with on-time deliveries, and access more profitable resources.

This article discusses the challenges faced by SMEs in their lean journey, with a focus on employees' perspectives on the lean transition. The aim of the study is to determine to what extent the basic principles of lean production are understood in SMEs in Bishkek and to identify possible obstacles that may affect the lean production implementation process.

Keywords: Lean manufacturing, 5S, Kaizen, SME



**EFFECT OF EMOTIONAL INTELLIGENCE ON EMPLOYEE PERFORMANCE:
EVIDENCE FROM GARMENT ENTERPRISES IN ETHIOPIA**

Sintayehu Assefa Yirga

Ph.D., College of Business and Economics, Department of Management, Hawassa University,
Ethiopia

Abstract

The main general objective was to determine the effects of Emotional Intelligence and employee performance in Garment enterprises in Ethiopia. Primary data for the study were obtained through questionnaires with the employees of the company. Pearson correlation and Regression have been used in this study. As a result, the correlational study revealed that Self Awareness, Self-Management, Social Awareness, and Relationship Management are found to have a significant effect on Employee Performance. The regression analysis result has revealed that Self-awareness, self-management, social awareness, and relationship management with employee performance are 0.545, -0.010, -0.167, and 0.010 respectively. Their significance levels are 0.000, 0.002, 0.002, and 0.000 respectively. The researcher recommended that the organization should work on its employee intelligence to enhance its performance.

Keywords: Self Awareness, Self-Management, Social Awareness, Relationship Management



YESTERDAY, TODAY, AND TOMORROW OF THE GENIUS HOUSE STUDIES

Hacı Mehmet YEŞİLTAS

Erol TAŞ

Meral ÇELİKOĞLU

Tülin HÜNDÜR

Res. Asst., Department of Science Education, Faculty of Education, Ordu University,
Ordu/TURKEY

Prof. Dr., Department of Science Education, Faculty of Education, Ordu University, Ordu/TURKEY

Res. Asst., Department of Science Education, Faculty of Education, Ordu University,
Ordu/TURKEY

Department of Science Education, Faculty of Education, Ordu University, Ordu/TURKEY

Abstract

Genius hour is based on the 20% time idea used in many other companies and organizations, including Google, 3M, National Public Radio, Flickr, and Huffington Post. Employees use 20% of their working time to pursue their passions, interests, and curiosity. For example, Google has developed applications such as Gmail, Google Earth, and Google Sky. After Genius hour began to be used in the training field, various studies were introduced in the field of education. These studies mainly include the use and various examples of Genius hour education, which is a new approach. The purpose of this study is to review the study of gene hour and provide information about its contents. It is designed using the document review method from qualitative research methods. The document review method covers the analysis of written materials containing information about the event or facts intended to be investigated. The study's databases reviewed are Web of Science, ERIC, Scopus, and Google Academic. For scans that are not a specific year's Curve, the training area includes articles, conference statements, books, and other materials. This is to examine the work done in the past and the present and to make an interest in the future.

Keywords: Genius Hour, Education, Teaching

INTRODUCTION

The economynomy, commerce, industry, and many other industry organizations need to make radical changes in their recruitment strategies. Based on this need, especially in the 21st century. Some needs and requirements change and diversify. The physically declining workforce and the rapidly increasing effect of technology create differences in human needs and job descriptions. Especially when we look at the previous years, even hundreds of years, we see that the duties in society are determined by extremely strict rules. Employers paid certain wages to their employees for performing certain duties. However, in our age, the expected demands are different. Our world is becoming a world that is not only developing but also changing. Changes in the human profile needed in this changing and developing world are inevitable (Orishev and Burkhonov,2021).

Especially creative and innovative thinking skills increase their importance day by day. In the world, individuals are provided with a period to develop their creative and innovative thoughts. However, the required human profile consists of individuals who think creatively and innovatively (Quinn, 2021). The starting point of this development in society is seen as schools. Students need to put forward innovative, creative, and productive ideas from the early stages, especially in terms of



keeping up with the change in the world (Krebs and Zvi. 2020). It is known that traditional education systems are applied to all students based on a curriculum. According to the idea that there is no individual difference between students, there is a common interest. It is thought that creating a period for students to search for answers to their areas of interest or curiosity will increase their scientific creativity and productivity. The genius hour teaching approach allows students to carry out research or projects in line with their interests in 20% of the weekly lesson hours.

The formation of original ideas is associated with more than one situation (Yeşiltaş et al., 2022). The subjects or objects of interest and curiosity of the individual affect her thoughts, ideas, or products. For this reason, it has been concluded that ideas formed in line with the fields of interest and passion increase creativity. (Sun, Wang, and Wegerif, 2020). Google, one of the leading companies in the world, has improved the creativity of its employees positively with the method called Genius Hour (Juliani, 2014). This method allows employees to research 20% of their working time in their fields of interest (Taş & Yeşiltaş, 2021). Genius hour aims to bring out students' passion and interest. In this way, it contributes to the development of creative thinking skills inside and outside the classroom (Wargo, 2022). Genius Hour also defines it as research-based, student-centered learning. It is aimed that students' interests and attitudes will guide their research questions and projects. During Genius hour, the common goals of the projects are to bring students productivity and new ideas (McNair, 2021). These goals are not limited to revealing the importance of scientific creativity today, but also emphasizing its development. It is known that Genius hour is an application that has just started to be used in the field of education (François and Janes, 2017). For this reason, many new studies may be carried out especially. It is thought that determining the trends of the studies carried out until today will be an opportunity in terms of the future period (Coke, 2018). The purpose of this research is to reveal the change in the field of a genius hour from the past to the present. At the same time, in light of the studies carried out, it aims to find suggestions for the studies that will be done or are planned to be done in the coming years.

For this purpose, answers to the following questions were sought:

Genius hour studies;

1. What's the distribution for years?
2. What is the distribution according to Databases?
3. What's the Distribution according to the research method?
4. How is the distribution according to the study groups?

METHOD

Content analysis is evaluated under three categories in the literature: a meta-analysis, meta-synthesis, and descriptive content analysis (Çalık and Sözbilir, 2014). Descriptive content analysis is used to determine the general trend in studies using both qualitative and quantitative research methods on the same subject. No time limit was applied in the studies planned to be examined. The databases examined, on the other hand, consist of Google Scholar, Web of Science, ERIC, and Scopus, respectively.

FINDINGS

In this part of the study, the research related to the research is included. When the studies in the field of Genius hour are examined, it is seen that the first studies started to be created in 2014. It is seen that 44 studies were carried out between 2014 and 2022. The distribution of the studies according to the type of publication is presented in Figure 1.

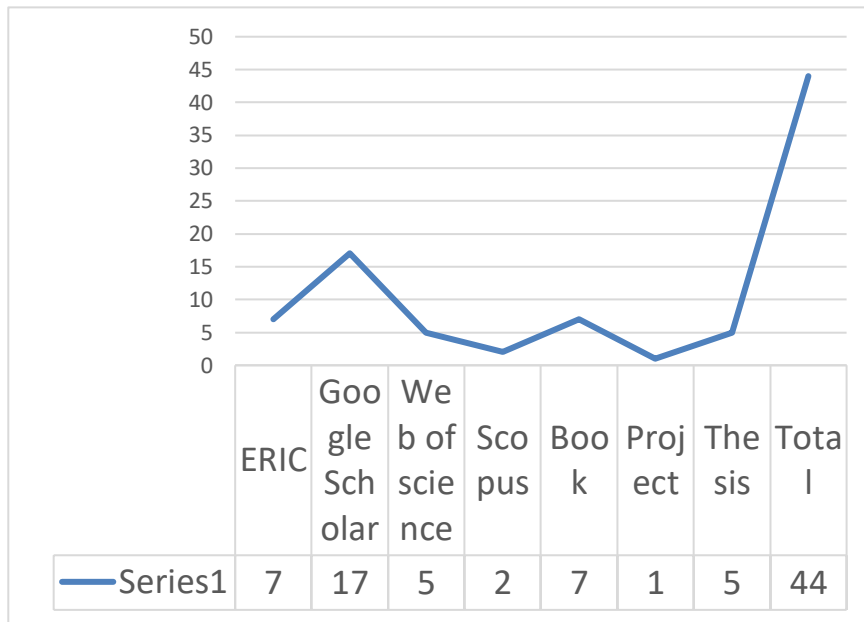

Figure 1. Distribution of studies according to databases

When Figure 1 was examined, it was observed that most of the studies were conducted in the Google scholar database. It is seen that the studies and book or book chapters realized in the ERIC database are realized in the same number. The distribution of the studies conducted in the field of Genius Hour by year is presented in Figure 2.

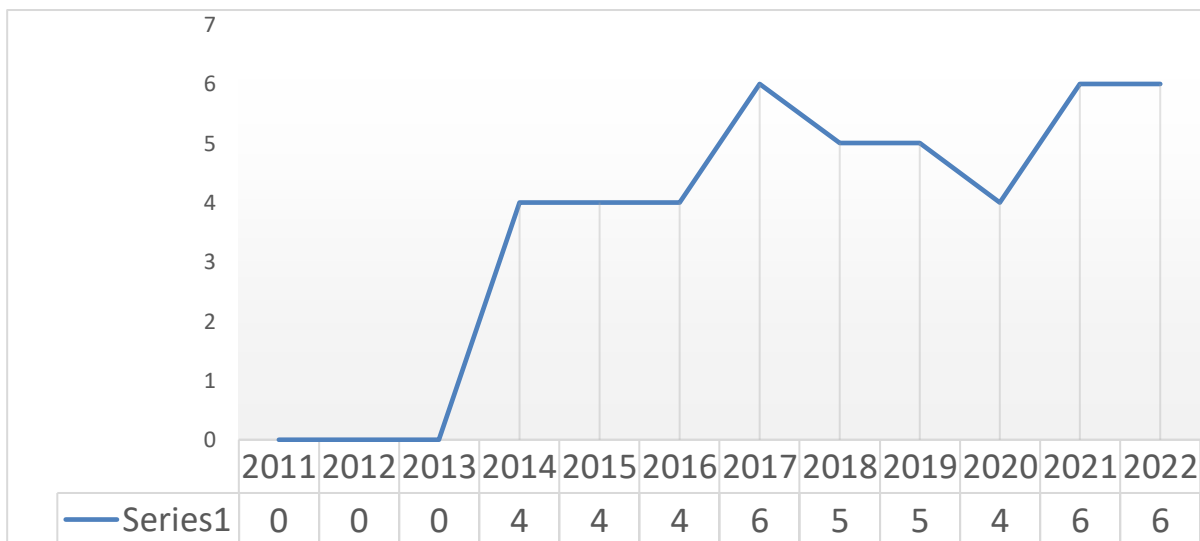

Figure 2. The distribution of studies over the years.

When Figure 2 is examined, it is seen that the highest number of studies took place in 2017, 2021, and 2022 with 6 studies. With this, it is determined that 5 studies were carried out in 2018 and 2019. Figure 3 presents their distribution according to the research methods used in the studies.

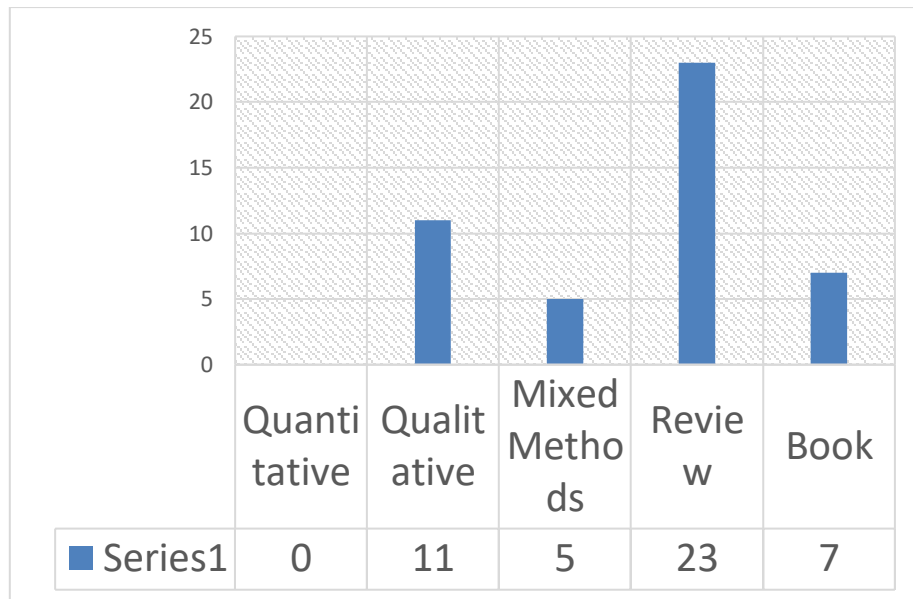

Figure 3. The distribution of studies according to the methods of research

When Figure 3 is examined, it is seen that most studies were carried out in the compilation type. In the qualitative research type, it is seen that eleven studies were carried out. In addition, it is concluded that five studies were carried out with mixed-method research and he wrote seven books or book chapters. Figure 4 shows the distribution of the study groups included in the studies carried out.

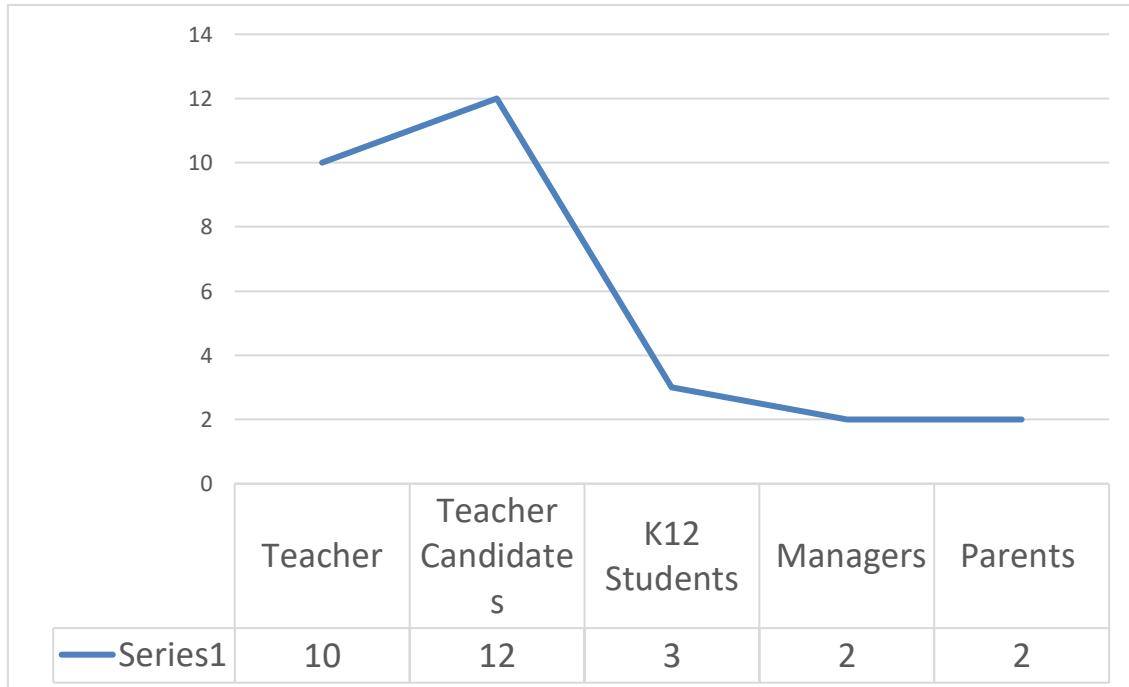

Figure 4. The study group in which the studies were carried out.

Figure 4 shows that most studies are done with teachers and teacher candidates. In addition, it has been determined that the studies carried out with students, parents and managers have been carried out in a small number.



DISCUSSION AND CONCLUSION

Figure 1 shows that most studies have been done in the Google Scholar database. One of the main reasons for this is that there are journals in the relevant database that are less accepted in the field of education. Compared to other databases, the time of publication is shorter and reviews of the quality of the content of the studies are performed at a lighter level. When the studies are examined, it is seen that the first studies were carried out in 2014. While it was observed that three studies were carried out until 2017, six studies were carried out in this number. Along with this, there was a decrease in the number of studies in 2020. The reason for this situation can be shown as the fact that education takes place online all over the world due to the covid pandemic. When the realized theses are examined, it can be stated that the reason for the high number of theses in 2017 is that the preparation processes took approximately three years. In addition, it is observed that there has been an increase in the number of studies in the last two years due to the gradual decrease in the effects of the pandemic period. The fact that the Genius hour is a new method in the field of education causes studies in the type of compilation and qualitative research, especially the authors. It is seen that the quantitative research approach is included in mixed method research, in which the results obtained from the scales are supported by interviews. The reason for this is that researchers generally aim to reveal the thoughts of individuals on the subject through interviews about new subjects (Reddy, Sharma, and Chaudhary, 2020). The main reason why the study groups are composed of teachers and teacher candidates is that they are practitioners of the method. It is concluded that the opinions of parents and administrators on the subject are taken to determine the suitability of the school curriculum. In addition, it is seen that informative activities take place only in K-12 classes in terms of practice. It is concluded that preliminary preparations have been made for the suitability of the Genius hour in the field of education. It is seen that the Genius hour applications are lacking in terms of application in general from the past to the present (Cremin and Chappell, 202). Apart from the studies in the compilation type, it was determined that studies were carried out to reveal the opinions of the individuals about the method. Considering the past and present of Genius hour, informative and explanatory studies have been carried out in terms of literature. Considering the future of Genius hour, it is foreseen that it will have differences from past studies (Krebs and Zvi. 2020).

Recommendations

When the studies are examined, it has been observed that theoretical information is given about genius hour in general. For this reason, it is recommended to carry out studies, especially for the implementation of the genius hour process at different teaching levels. In addition to this, it is recommended to prefer studies that explain the steps to be followed in the implementation process, rather than theoretical information about genius hour.

REFERENCES

- Coke, P. K. (2018). Using genius hour to change what we do with what we know. *The English Journal*, 107(6), 26-30.
- Cremin, T., & Chappell, K. (2021). Creative pedagogies: A systematic review. *Research Papers in Education*, 36(3), 299-331.
- Çalık, M. ve Sözbilir, M. (2014). İçerik analizinin parametreleri. *Eğitim ve Bilim*, 39(174), 33-38.
- François, T., & Janes, D. (2017). Genius Hour Assignment: Choosing ICT for Second and Foreign Language Instruction—A New Framework. *LEARNING*.
- Juliani, A. J. (2014). *Inquiry and innovation in the classroom: Using 20% time, genius hour, and PBL to drive student success*. Routledge.
- Krebs, D., & Zvi, G. (2020). *The genius hour guidebook: Fostering passion, wonder, and inquiry in the classroom*. Eye on Education.



INTERNATIONAL ASIAN CONGRESS ON CONTEMPORARY SCIENCES – VII

- Irish, J., & Burkhonov, R. (2021). Project for training professional skills for future teachers of technological education. *Mental Enlightenment Scientific-Methodological Journal*, 2021(2), 139-150.
- Quinn, D. J. (2021). *Genius Hour: Educator Perspectives on Navigating the Prompts, Promises, and Predicaments of Implementing Interest-Driven Learning in Public Schools* (Doctoral Dissertation, University of Rhode Island).
- Reddy, P., Sharma, B., & Chaudhary, K. (2020). Digital literacy: A review of the literature. *International Journal of Technoethics (IJT)*, 11(2), 65-94.
- Sun, M., Wang, M., & Wegerif, R. (2020). Effects of divergent thinking training on students' scientific creativity: The impact of individual creative potential and domain knowledge. *Thinking Skills and Creativity*, 37, 100682.
- Taş, E., & Yeşiltaş, H. M. (2021). *Genius Hour in Science Education, II*. International Hazar Scientific Research Conference, April 10 - 12, 2021, Baku, Azerbaijan.
- Wargo, J. M. (2022). Gendered Genius Hour: Tracing Young Children's Uptake of Expert across the Nexus of Personal Digital Inquiry. *Research in the Teaching of English*, 56(3), 275-300.
- Yeşiltaş, H. M., Çelikoğlu, M., Hündür, T. ve Taş, E., (2022). *Individualized Education In Science Teaching, III*. International Congress of Modern Studies in Social Sciences and Humanities. Karabagh/Azerbaijan



**DESCRIPTIVE CONTENT ANALYSIS FOR ANXIETY STUDIES IN SCIENCE
TEACHING**

Tülin HÜNDÜR

Erol TAŞ

Hacı Mehmet YEŞİLTAS

Meral ÇELİKOĞLU

Department of Science Education, Faculty of Education, Ordu University, Ordu/TURKEY

Prof. Dr., Department of Science Education, Faculty of Education, Ordu University, Ordu/TURKEY

Res. Asst., Department of Science Education, Faculty of Education, Ordu University, Ordu/TURKEY

Res. Asst., Department of Science Education, Faculty of Education, Ordu University, Ordu/TURKEY

Abstract

Anxiety, which is one of the most important factors affecting the learning and teaching process, appears in academic subjects and in various stages of daily life and is seen as a negative factor for teachers, one of the cornerstones of education. It has been determined in published studies that teachers who are new to the profession have higher science teaching anxiety than more experienced teachers. In this case, there are also studies in the literature that it would be beneficial to determine the concerns about science teaching and take precautions during the teaching profession. For this reason, the aim of our study is to determine the general trend of studies published on science teaching anxiety in our country between the years 2012-2022. For this purpose, two types of studies published in Turkey, which are articles and thesis, are examined. The studies are analyzed using the descriptive content analysis method by scanning the databases of TR Index, ERIC, DergiPark, Google Scholar, YÖK Thesis Center. While the studies were examined, evaluations were made on many criteria such as publication year, publication type, research method, sample determination method, sample group and number, data collection time and tools, data analysis method. The analyses performed according to these criteria were presented using descriptive statistical techniques such as frequency and percentage. Within the scope of the research, candidate studies were determined and a total of 42 studies were evaluated. It is thought that the results obtained from the study will be useful in terms of seeing the strengths and deficiencies of the studies in the field and can be used as a decisive source in directing the future studies.

Keywords: Anxiety, teaching anxiety, science teaching anxiety, descriptive content analysis

INTRODUCTION

Anxiety is defined as a state of anxiety that encourages or prevents behavior in a constructive, creative state both in daily life and in educational life (Başarır, 1990). Anxiety can occur when teaching a subject as it does when learning. For this reason, it is seen as one of the most important factors affecting the teaching and learning process, and the anxiety specific to teaching is characterized as teaching anxiety (Türkmenoğlu, Aytekin & Arıkan, 2019). Teaching anxiety is expressed as a factor that prevents the development of the child's problem-solving skills with the inadequate knowledge of the teacher and the method techniques used in teaching. Science teaching anxiety, which is seen as one of the teaching concerns, is defined as fear of science concepts, scientists, and science-related activities (Akkoyun, 2020; Gögebakan, 2020).



Limitations of the Research: Since the studies examined are only aimed at science education between 2012-2022, they do not reveal ideas about other disciplines and date ranges. The fact that the studies whose sample of the study is Turkey has been examined reveals a limitation in terms of generalizability and comparability. While the analysis scheme used in the study and created by the researchers is an alternative to coding existing publications, different analysis rubrics can also be used to code these studies.

Purpose and Importance of the Study: Anxiety can be a significant problem in the teaching process as well as in every moment of life. Teaching concerns, which are stated as tensions between teachers and students about the transfer of concepts and problem solving related to any subject in the teaching environment, are thought to be based on past learning experiences (Akkoyun, 2020). The anxiety that teachers experience while learning science during their student years reveals the anxiety in transferring this information to the students after becoming a teacher and this cycle continues in their students (Peker, 2006). With the descriptive content analysis of current studies, it is aimed to reveal a reflection of the anxiety situation in science education and to guide future studies with a critical perspective. In addition, it is aimed to examine the studies on anxiety in science education in terms of different parameters and to put a general diagram into consideration and to guide both the future studies and the teachers. In this case, the problem sentence of the study is "What are the general trends in the articles and thesis studies published on 'science education anxiety' in Turkey in the last decade?"

Sub Problems: In line with the aim of the study, answers to the following sub-problems were sought:

- 1) How is the distribution according to the type of publication?
- 2) What is the distribution according to the year of publication?
- 3) How is the distribution according to the research method?
- 4) What is the distribution according to the sampling method?
- 5) What is the distribution according to the sample group?
- 6) How is the distribution according to the number of samples?
- 7) What is the distribution of data collection tools according to type?
- 8) What is the distribution of data according to the data collection process in the research?
- 9) How is the distribution according to the data analysis method?

METHOD

In this study, descriptive content analysis method, which is a type of content analysis, was used. Descriptive content analysis: It is a type of approach that involves the identification and regulation of the tendencies and results of both quantitative and qualitative studies conducted within the framework of a specific subject (Çalık & Sözbilir, 2014). With this aspect, it provides an opportunity for researchers who will study this subject to obtain information about a general orientation (Namdar & Küçük, 2018). In this study, by using descriptive content analysis, studies on science education anxiety between 2012-2022 were examined in various aspects and a general trend was put in the middle. At the end of the scan's, repeated studies were removed and candidate studies to be included in the research were determined. Accordingly, the number of studies examined within the scope of the research is given in Table 1.

Table 1. Number of studies examined within the scope of the research

DATABASE / INDEXES	STUDY NUMBER
GOOGLE SCHOLAR	6
TR DİZİN	4
DERGİPARK	9
YÖK THESİS	19
ERİC	4
TOTAL	42



Selection of Studies and Data Collection as a Result of Literature Review: To reach the studies on science education anxiety in Turkey between 2012-2022, TR Dizin, ERIC, DergiPark, Google Scholar, YÖK Thesis databases were scanned. As a keyword when scanning from databases, different combinations such as science teaching, anxiety, teaching anxiety, science anxiety, science teaching anxiety, descriptive content analysis, science teaching, anxiety, teaching anxiety, science anxiety, descriptive content analysis were used. In this way, 42 studies published in databases were reached. As the criteria for including the studies in the research, it was determined that it was a study on science education concerns conducted between 2012-2022 and the research whose publication place was Turkey. While article and thesis type publications were included in the research, other publication types such as book chapters and papers were not included. The focus of the research is on the studies carried out with both teachers and students starting from the primary education level to the last level of higher education. Qualitative, quantitative or mixed research methods were used in the research, and research published in journals or thesis center where the full text was reached were included.

Analysis of Data: The studies reached with the criteria determined in this study are coded in detail in line with some parameters. The coding scheme was structured based on the content analysis studies conducted by the researchers (Ayvaci & Sezer, 2018; Oğuzman, Metin & Hasan, 2021; Namdar & Small, 2018). Studies: publication year, publication type, research method, sample determination method, sample group and number, data collection time and tools, data analysis method were examined under nine basic headings and these parameters determined the themes. Themes and codes are included in the findings section and interpreted.

FINDINGS

The studies and themes examined within the scope of the research are presented in this section. The representation of the data is given in tables and figures under the headings of the themes. The distribution of studies on the theme of purpose is presented in Figure 1.

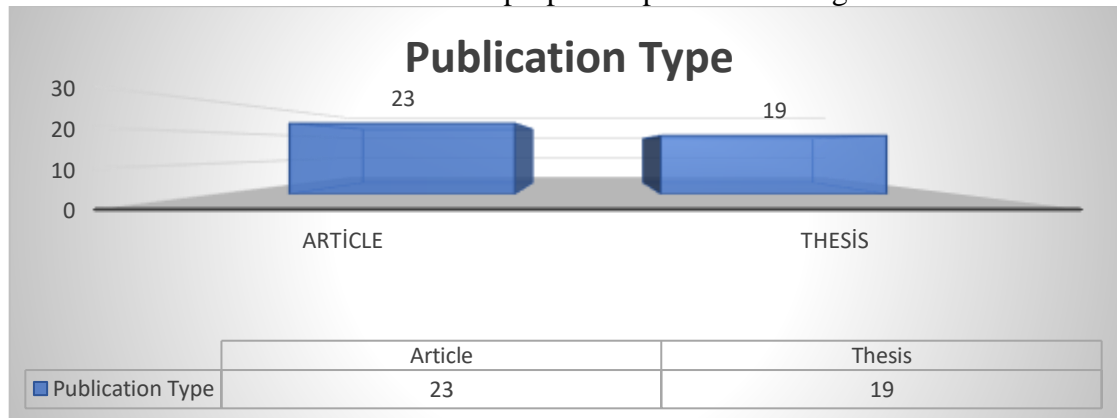

Figure 1. Distribution of Studies According to Publication Type

When the distribution of the studies on science teaching anxiety related to the 1st sub-problem is examined according to the type of publication, it is seen that 19 of the related studies are thesis and 23 studies are articles.

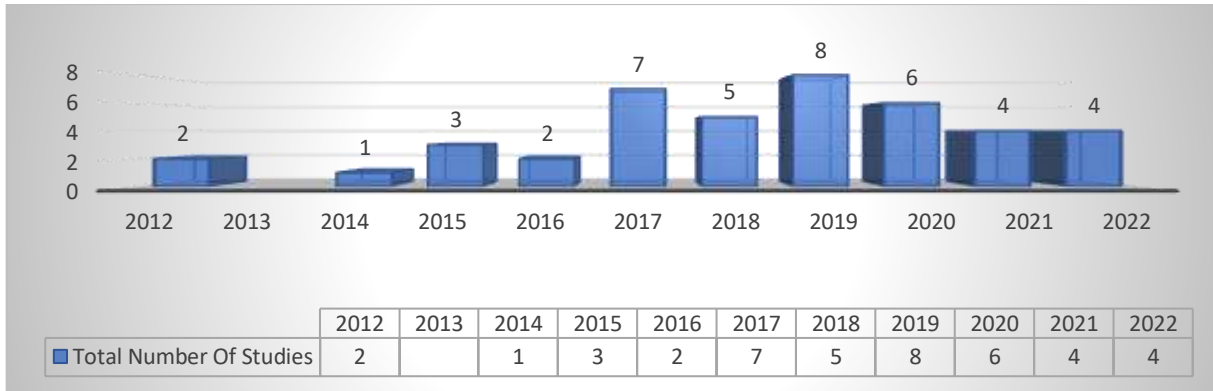

Figure 2. Distribution of Studies According to Year of Publication

When Figure 2 was examined, it was determined that the most 8 studies were conducted in 2019, followed by the studies conducted in 2017 and 2020, the least number of studies was from 2014, and no studies were conducted in 2013.

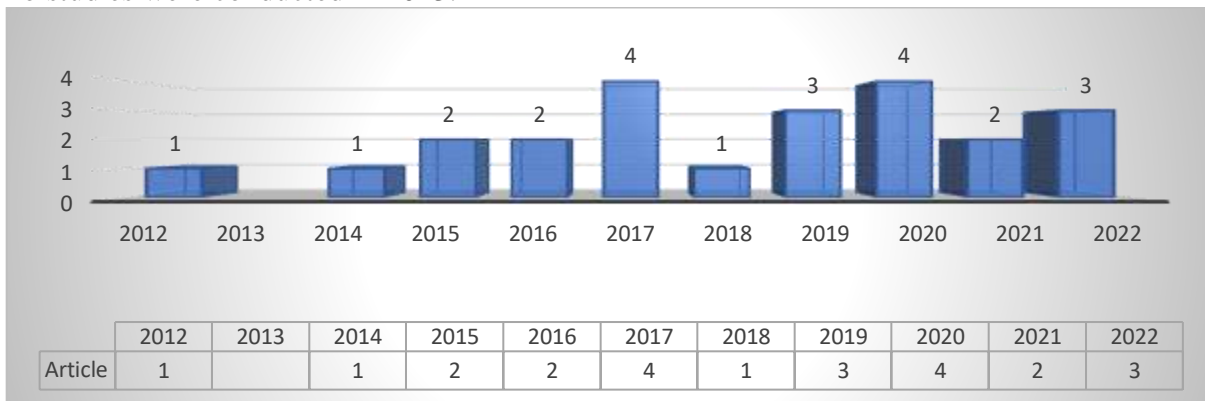

Figure 3. Distribution Of Study Type (Article) According to Year

When Figure 3 is examined, it can be mentioned that there is an increasing tendency of the number in article studies according to years. While this situation showed a significant increase especially in 2017-2020, it was determined that no studies were conducted in 2013 and the least studies were done in 2012-2014-2017.

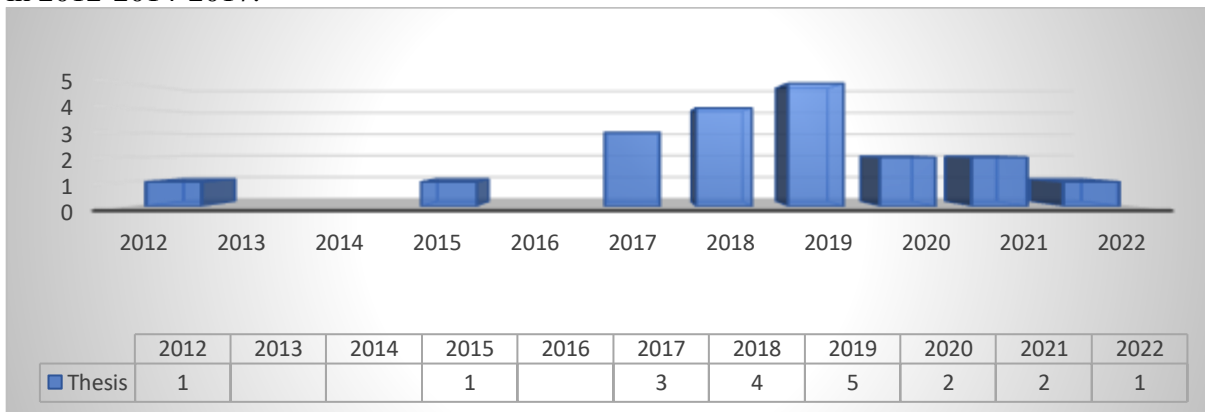

Figure 4. Distribution Of Work Type (Thesis) According to Year

When Figure 4 was examined, it was determined that the number of thesis studies showed an increasing trend between 2017-2019 and that there were no studies between 2013-2014-2016.

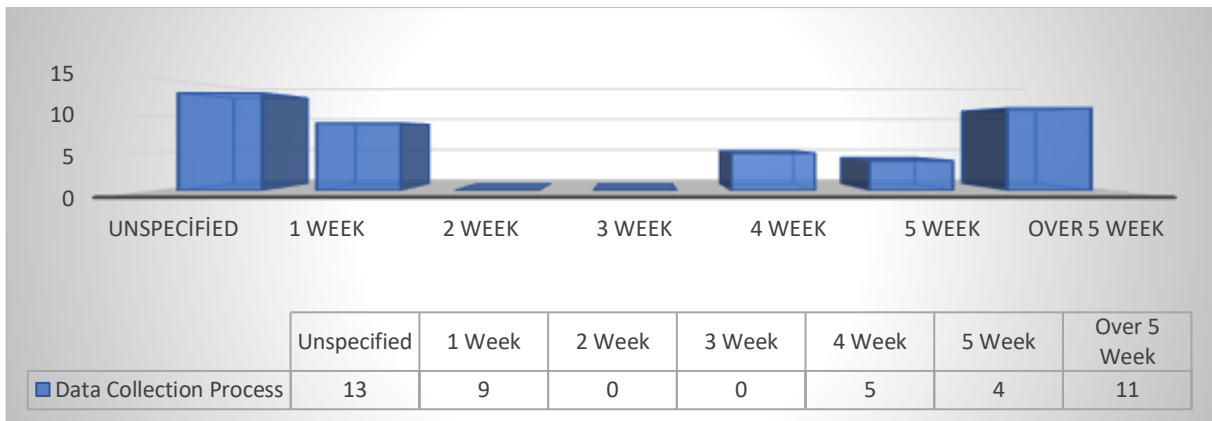

Figure 5. Distribution Of Studies According to The Periods Performed

When Figure 5 is examined, the distribution of the studies according to the data collection times varies according to the type of study and it is found that the studies performed for 1 week or less are more.

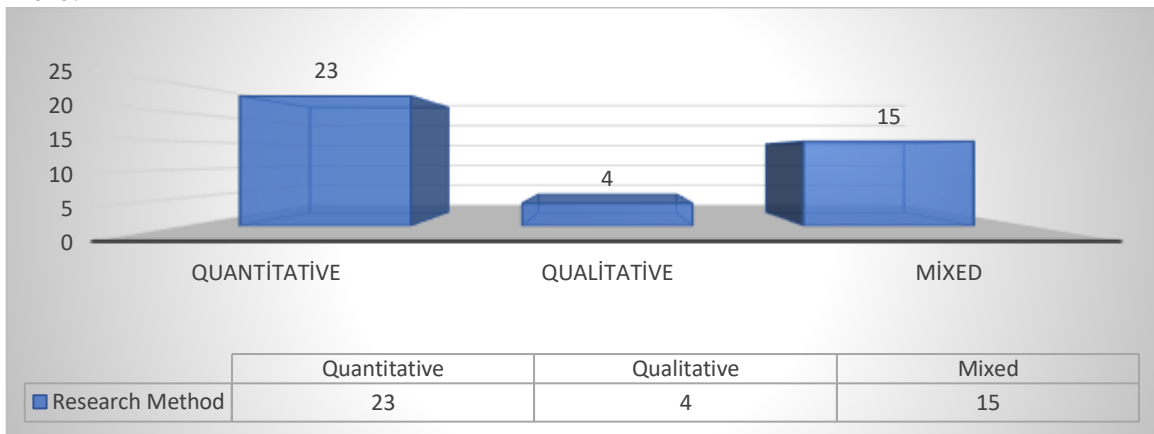

Figure 6. Distribution Of Studies According to Research Method

When the research methods used are examined, it is seen that researchers often benefit from quantitative and mixed research methods, but the number of qualitative method studies is less than these methods. It is seen that 23 quantitative, 15 mixed and 4 qualitative methods were used in the studies.

Table 2. Distribution Of Studies According to Sample Determination Method

SAMPLE DETERMINATION METHOD	ARTICLE		THESIS		TOTAL	
	F	%	F	%	F	%
UNSPECIFIED	11	47,8	-	-	11	26,2
SIMPLE SELECTION	6	26,1	5	26,3	11	26,2
APPROPRIATE SAMPLE	1	4,3	3	15,8	4	9,5
INTENDED SAMPLE	5	21,8	11	57,9	16	38,1
TOTAL	23	100	19	100	42	100

When Table 2 is examined the simplest random sampling method was used most in the article studies on science teaching anxiety, and the purposeful sampling method was used in the thesis studies. In general, it is observed that the appropriate sampling method is the least preferred sampling method in the studies and the sampling method is not specified in a total of 11 studies.



Table 3. Distribution Of Studies According to Sample Group

SAMPLE GROUP	ARTICLE		THESIS		TOTAL	
	F	%	F	%	F	%
STUDENT	5	21,8	11	57,9	16	38,1
TEACHER	18	78,2	8	42,1	26	61,9
TOTAL	23	100	19	100	42	100

In Table 3, when the distribution of the article studies according to the sample groups in which the research was carried out was examined, 5 different researches were carried out with the participation of the students and 18 different researches were carried out with the participation of the teachers, while 11 different researches were carried out with the participation of the students and 8 different researches were carried out with the participation of the teachers in the thesis studies.

Table 4. Distribution Of Studies According to Number of Sample

SAMPLE NUMBER	ARTICLE		THESIS		TOTAL	
	F	%	F	%	F	%
0-100	10	43,5	10	52,7	20	47,6
100-200	4	17,4	4	21,1	8	19,05
200-300	6	26,1	2	10,5	8	19,05
300-400	2	8,7	1	5,2	3	7,1
400-500	1	4,3	-	-	1	2,4
500 and over	-	-	2	10,5	2	4,8
TOTAL	23	100	19	100	42	100

When the distribution of the studies according to the number of samples in Table 4 was examined, it was determined that 20 studies in the range of 0-100 were included in the number of samples participating in the most studies, and that the thesis studies in the range of 400-500 participants and 500 and more participant article studies were not carried out.

Table 5. Distribution Of Studies According to Type of Data Collection Tools

DATA COLLECTION TOOLS	ARTICLE		THESIS		TOTAL	
	F	%	F	%	F	%
TESTS	3	9,4	10	27,1	13	18,9
SCALES	20	62,5	18	48,6	38	55,1
INTERVIEW	6	18,7	8	21,6	14	20,1
SURVEY	1	3,2	-	-	1	1,5
OBSERVATION	2	6,2	1	2,7	3	4,4
TOTAL	32	100	37	100	69	100

When the distribution of data collection tools given in Table 5 is examined, it is seen that the number of data collection tools is more than the number of studies examined because more than one data collection tool is used in some studies. In the studies, it was determined that the most scales (38 pieces) and the least questionnaires (1 piece) were preferred as data collection tools.

**Table 6.** Distribution Of Studies According To Data Analysis Method

DATA ANALYSIS METHOD	ARTICLE		THESIS		TOTAL	
	F	%	F	%	F	%
DESCRIPTIVE ANALYSIS	14	24,1	21	30,9	35	27,7
CONTENT ANALYSIS	7	12,1	5	7,3	12	9,5
T TEST	9	15,5	10	14,7	19	15,1
KRUKSAL WALLİS H TEST	2	3,4	4	5,8	6	4,7
MANN WHİTNEY U TEST	3	5,1	8	11,7	11	8,7
SHAPIRO WİLK TEST	--	--	3	4,4	3	2,4
WİLCOXON SİGNEİ RANKS TEST	1	1,7	3	4,4	4	3,2
ANOVA	8	13,8	8	11,7	16	12,7
ANCOVA	2	3,4	4	5,8	6	4,8
MANOVA	1	1,7	1	1,5	2	1,7
KOLMOGOROV-SMİRNOW TEST	4	6,9	1	1,5	5	3,9
FACTOR ANALYSIS	5	8,6	-	-	5	3,9
REGRESSION	2	3,4	-	-	2	1,7
TOTAL	58	100	68	100	126	100

When Table 6 is examined, it is seen that descriptive analysis and t test are used the most among the data analysis methods in the studies on anxiety in science teaching, and MANOVA and regression analyzes are used at least and quantitative methods are generally prominent in the studies.

RESULTS AND DISCUSSION

In this study, descriptive content analysis was performed in order to examine the published studies on science education anxiety between 2012-2022. For this purpose, a total of 42 studies related to science education concerns published in TR Dizin, ERIC, DergiPark, Google Scholar, YÖK Thesis databases were examined. These studies were classified and analyzed according to their type, distribution according to years, research method, sample group and number, sample determination method, data collection time and tools, and data analysis methods. It has been determined that studies on science education anxiety in Turkey have increased in recent years. It is anticipated that the increase in the research trend in Turkey on science education anxiety will continue. Similarly, when the literature is examined, it is seen that the studies on science teaching anxiety are increasing and becoming widespread day by day (Asal & Turan, 2021; Polat, Ulunay, & Başarmak, 2021; Akkoyun & Topaslan, 2022). It is stated that meeting the educational expectations for science teaching affects the knowledge, experience, self-efficacy, attitude, success and motivation of both teachers and students and affects all skills both mentally and physically (Akkoyun & Topaslan, 2022). As a result of the examination of the studies in terms of method, it indicates that the researchers mostly use quantitative research methods and this situation indicates that the findings of the studies on science teaching anxiety are often presented about what the results are. It has been determined that researchers conducting studies on science teaching anxiety often prefer the purposeful sampling method as a sampling method and studies supporting this result have been found in the literature (Gürbüzöğlü & Bakırcı, 2020; Kırmızıgöl, 2019; Kazan, 2021). When the distribution of sample groups in the studies was examined, it was determined that the most studies were done with teachers. In order to see the current situation of the participants in science teaching, the fact that the number of researches conducted for both teachers and students is high may also be related to the negative reflection of teaching anxiety on the lessons and finding solutions to this situation. Some studies in the literature are similar to this result (Nozoğlu, 2020; Şahin, 2019; Bozkurt, 2019). While the most commonly used data collection tool in research is scales, tests and interviews follow. It is seen in the examinations that researchers focus on studies to determine the opinions of teachers on this subject such as mood, knowledge, experience and self-efficacy about the subject of science teaching anxiety.



In particular, it is seen that the use of scale is preferred in determining the emotional state of the participant because the process of preparing, applying and collecting data is easy and much more data can be accessed in a short time. In this respect, it is seen that the results of the study are in parallel with other studies conducted in the literature (Erkol & Gül, 2020; Hacıoğlu, 2022; Kazan, 2021). When the data analysis methods used in the studies are examined; The three most commonly used methods are descriptive analysis, ANOVA, and t-test, respectively, accounting for almost half of all analysis methods. This result is a natural consequence of the fairly frequent use of scales in data collection tools. These analysis methods are widely used by researchers and considering that experimental research is the most commonly used method after case studies in researches on this theme, this can be considered as an expected result in this use (Özdemir, 2010).

In line with the findings of the current content analysis study, the following suggestions can be offered to researchers: It can be done in a way that reflects the research processes on science teaching anxiety in Turkey with a wider picture, by examining the anxiety studies on science teaching to researchers more comprehensively, by addressing large masses and by examining more number of journals including indexed and non-indexed ones as long-term studies. In order to minimize the level of anxiety towards science teaching, teaching practices can be given more space at all grade levels. Since students take the teaching practice course in their last year, it can be ensured that students go to schools at previous grade levels and do activities related to teaching. This study, which was carried out only with the sample of Turkey, can be repeated with written sources in foreign languages. The use of simple random and purposive sampling method in studies shows that it is preferred to work with easily accessible samples. In order to increase the external validity and reliability of the studies, it should be studied with sufficiently large samples that are believed to represent the population best. The content analysis of the studies published in different databases for science teaching and the determination of the trends in the field and the elimination of deficiencies with the studies carried out by using this method will contribute to the literature. It may be useful to perform content analyzes of the studies again after a certain period of time to see the positive and negative results of the changes in science teaching anxiety level.

REFERENCES

- Akkoyun, M. N. & Topaşlan, A. K. (2022). İlkokulda Fen Bilimleri Öğretimi ve STEM Uygulamaları: Sınıf Öğretmenlerinin Genel Kaygı Durumları. *Milli Eğitim Dergisi*, 51(235), 2031-2060.
- Akkoyun, M. N. (2020). STEM Eğitimi Almış Sınıf Öğretmenlerinin Fen Bilimleri Öğretiminde Yaşadıkları Kaygı Düzeyleri ve STEM Temelli Ders Etkinlikleri Hakkındaki Görüşleri. *Yüksek Lisans Tezi, İstanbul Aydın Üniversitesi, İstanbul.*
- Asal, R., & Turan, B. N. (2021). Sınıf Öğretmeni Adaylarının Fen Öğretimine Yönelik Kaygı Düzeylerinin Farklı Değişkenlere Göre İncelenmesi. *Erciyes Journal Of Education*, 5(1), 74-86.
- Ayvacı, H. Ş., & Sezer, K. (2018). Astronomi ile İlgili Yapılan Çalışmalara Yönelik Betimsel İçerik. *International E-Journal Of Educational Studies*, 3(5), 47-57.
- Başarır, D. (1990). Ortaokul Son Sınıf Öğrencilerinde Sınav Kaygısı, Durumluk Kaygı, Akademik Başarı ve Sınav Başarısı Arasındaki İlişkiler. *Yüksek Lisans Tezi, Hacettepe Üniversitesi, Ankara.*
- Bozkurt, D. M. (2019). Fen-Teknoloji-Mühendislik-Matematik (FETEMM) Yaklaşımının 6. Sınıf Madde ve Isı Konusunun Öğretiminde Etkililiğinin İncelenmesi. *Yüksek Lisans Tezi. Kilis 7 Aralık Üniversitesi. Kilis*
- Çalık, M., & Sözbilir, M. (2014). İçerik Analizinin Parametreleri. *Education & Science/Eğitim ve Bilim*, 39(174), 33-38.
- Erkol, M., & Gül, Ş. (2020). Fen Bilgisi Öğretmen Adaylarının Sosyobilimsel Konulara Yönelik Tutumları. *PESA Uluslararası Sosyal Araştırmalar Dergisi*, 6(1), 9-21.



- Gögebakan, S. (2020). Ortaokul 8. Sınıf Öğrencilerinin Fen Bilimleri Dersine Yönelik Kaygılarının İncelenmesi. Yüksek Lisans Tezi, Ağrı İbrahim Çeçen Üniversitesi, Ağrı.
- Gürbüzkol, R., & Bakırcı, H. (2020). Fen Bilimleri Öğretmenlerinin Sosyobilimsel Konular Hakkındaki Tutum ve Görüşlerinin Belirlenmesi. Yüzüncü Yıl Üniversitesi Eğitim Fakültesi Dergisi, 17(1), 870-893.
- Hacıoğlu, C. H. (2022). Sosyobilimsel Konularda Argümantasyona Dayalı Öğretimin Etkileri: Gdo Örneği. Yüksek Lisans Tezi. Kırşehir Ahi Evran Üniversitesi, Kırşehir.
- Kazan, M. (2021). Fen Bilimleri Öğretmenlerinin Laboratuvar ve Öğretim Sürecine İlişkin Kaygı Düzeylerinin Belirlenmesi. Yüksek Lisans Tezi. Aksaray Üniversitesi, Aksaray.
- Kırmızıgül, A. S. (2019). Fen Eğitiminde Bilgisayar Destekli, Etkinlik Temelli ve Sorgulamaya Dayalı Öğretim Yaklaşımlarının Karşılaştırılması. Doktora Tezi. Erciyes Üniversitesi, Kayseri.
- Namdar, B., & Küçük, A. (2018). Fen Eğitiminde Teknoloji Entegrasyonu Çalışmalarının Betimsel İçerik Analizi: Türkiye Örneği. Mehmet Akif Ersoy Üniversitesi Eğitim Fakültesi Dergisi, (48), 355-383.
- Nozoğlu, F. (2020). Fen Bilgisi Öğretmen Adaylarının Fizik Dersine Yönelik Kaygı Düzeylerinin Belirlenmesi ve Fizik Kaygısı ile Başa Çıkma Yaklaşımları. Yüksek Lisans Tezi. Fırat Üniversitesi, Elazığ.
- Oğuzman, T., Metin, M., & Hasan, K. (2021). Türkiye'deki Astronomi Eğitimi Araştırmalarının İncelenmesi: Bir Betimsel İçerik Analizi. Maarif Mektepleri Uluslararası Eğitim Bilimleri Dergisi, 5(1), 43-65.
- Özdemir, M. (2010). Nitel Veri Analizi: Sosyal Bilimlerde Yöntembilim Sorunsalı Üzerine Bir Çalışma. Eskişehir Osmangazi Üniversitesi Sosyal Bilimler Dergisi, 11(1), 323-343.
- Peker, M. (2006). Matematik Öğretmeye Yönelik Kaygı Ölçeğinin Geliştirilmesi. Eğitim Bilimleri ve Uygulama, 5(9), 73-92.
- Polat, D., Uluay, G., & Başarmak, U. (2021). Examining The Pre-Service Teachers' Components Of Self-Efficacy Beliefs İn Science Teaching (Sebst). Sakarya University Journal Of Education, 11(1), 195-217.
- Şahin, D. (2019). Artırılmış Gerçeklik Teknolojisi ile Yapılan Fen Öğretiminin Ortaokul Öğrencilerinin Başarılarına ve Derse Karşı Tutumlarına Etkisi. Yüksek Lisans Tezi. Atatürk Üniversitesi, Erzurum.
- Türkmenoğlu, H., Aytekin, C. & Arıkan, N. (2019). Sınıf Öğretmeni Adaylarının Matematik ve Fen Öğretimi Kaygılarının İncelenmesi. Kırşehir Eğitim Fakültesi Dergisi, 20(3), 1545-1594.



**BIBLIOMETRIC ANALYSIS OF STUDIES on COMPUTATIONAL THINKING and
“UNPLUGGED” LEARNING STRATEGY in SCIENCE EDUCATION**

Meral ÇELİKOĞLU
Hacı Mehmet YEŞİLTAS
Tülin HÜNDÜR
Erol TAŞ

Ordu Üniversitesi, Eğitim Fakültesi, Fen Bilgisi Eğitimi Anabilim Dalı, Ordu, Türkiye.

Abstract

In this study, a bibliometric analysis was carried out to reveal the intellectual structure and the trends in the field of computational thinking studies carried out using the unplugged learning strategy in science education. For this purpose, the Web of Science database was selected and the keywords "Computational thinking" AND "science education" AND "(unplugged OR kinesthetic OR without computers)" were used to find the related publications. A total of 323 studies were accessed, and 29 studies were included in the bibliometric analysis with inclusion and exclusion criteria. In data analysis, the “biblioshiny” package program was used which is an R Studio program for bibliometrix package (Aria and Cuccurullo, 2017). As a result, computational thinking studies carried out using the unplugged strategy in science education have been carried out since 2013, scientific productivity is below the expected level, authors generally contribute to the field with only one study, international cooperation is limited, authors prefer computer science sources, and trend study topics in the field are computational thinking, science, programming, student, and activity. In addition, thematic mapping and factorial analysis of the field were also carried out. We determined that the field of computational thinking, using unplugged learning approach in science education, is very young and focuses on the integration of curriculum, learning products and processes. The STEM field is still a trending field, but how it affects learning in terms of science-specific skills is predicted to be trend.

Keywords: Computational thinking, unplugged, science education

INTRODUCTION

In recent years, computational thinking skill has been introduced as a skill that attracts attention all over the world and that all individuals should have (Wing, 2006). So much so that it was quickly included in the curriculum of many countries (Seow, Looi, How, Wadhwa, and Wu, 2019). Computational thinking (CT) is a transversal and complex competence that goes beyond computer use and coding (Borrega, Berrocoso, and Arroyo, 2022). According to Wing (2006), CT includes problem-solving, system design, and understanding human behavior. At the same time, CT refers to recognizing the aspects of real-world problems suitable for computational formulation and evaluating and developing algorithmic solutions to these problems so that solutions can be made functional with a computer (Fraillon et al., 2022, p. 27). In short, computational thinking can be defined as the ability to produce effective and efficient algorithmic solutions by using mental processes in knowledge construction. We can see that many definitions in the field focus on problem-solving skills. Although the literature focuses on the theoretical definitions of computational thinking, we may say that some researchers focus on the operational definitions of CT. Huang and Looi (2021) framed CT a broadly applicable set of problem-solving skills, including abstraction, decomposition, pattern recognition, and algorithmic thinking. Mensan, Osman ve Majid (2020) defined abstraction,



decomposition, pattern recognition, and algorithmic thinking operationally in their study. Abstraction is highlighting the necessary details and eliminating unnecessary details to better understand a task or problem such as analytical thinking, decomposition is breaking down a set of tasks or problems into smaller and more manageable parts, pattern recognition is identifying patterns in features, and processes or relationships in a task or problem to structure knowledge and solve a similar task or problem with the same strategy and algorithmic thinking is presenting the solution or creating a set of step-by-step instructions when solving a task. As it can be understood from both theoretical and operational definitions, we may say that the skills on which computational thinking is based focus on problem-solving skills.

Computational Thinking in Science Education

Computational thinking skills will become a required competency in all professions that require 21st-century skills. Science, on the other hand, is a branch of science that aims to understand and comprehend nature and the universe in which it lives, and applications for this are carried out. Therefore, in many ways, the paths of computational thinking and science intersect. CT and programming processes take place in many fields from space sciences, physics, chemistry, biology, medicine, biotechnology, nanotechnology, and aviation (Arik and Topçu, 2022). Regarding computational modeling, Peel, Sadler, and Freicrichsen (2022) give a recent example in their study. For example, the rapid introduction of COVID-19 vaccines to humanity was made possible by computational models that read the genetic code of the virus and predict certain parts of the virus that would be the best targets for the immune response. The science subjects in which CT is integrated into the literature are; the digestive system (Arik and Topçu, 2022), the Human genome project, natural selection (Peel et al., 2019), cell, matter, periodic table, light, and optics (Lapawi and Husnin, 2020), black holes (Event Horizon M87, 2019), gravitational Waves (Abbott, Abbott, Abbott, and Abernathy 2016), electrical circuits (Lin and Shaer, 2016).

Unplugged Strategy

In the literature, Unplugged approaches, tinkering, making, and remixing are used for the integration of CT into lessons in science education (Arik and Topçu, 2022). On the other hand, we may see that the most common approach used in science education is the unplugged approach (Kakavas and Ugolini, 2019). Although the unplugged learning approach is not a new approach (Bell, Witten, and Fellows, 1998), it has gained importance in the upskilling of Computational Thinking skills in recent years (Huang and Looi, 2021). CS Unplugged (2019) organization, founded by Tim Bell, Ian Witten, and Michael Fellows, was the first organization to define unplugged activities (Yıldız and Karal, 2021) (https://classic.csunplugged.org/documents/books/english/CSUnplugged_OS_2015_v3_1.pdf). Unplugged activities that do not involve the use of digital devices such as computers, mobile phones, tablets, etc. (Bell et al., 1998). This is a suitable approach for schools that do not have the sufficient technological infrastructure, in terms of providing equal opportunities in regions or countries where such opportunities are limited (Unnikrishnan, Amrita, Muir, and Rao, 2016). Also, in many cases, these activities are used as precursors to code-based CT applications (Kite and Park, 2022). The unplugged approach that is used in teaching the philosophy of CT and its effectiveness has been stated in many studies (Bell, Witten, and Fellows, 2015).

The integration of computational thinking with different learning strategies or methods in science education is important for 21st-century skills. Especially since Wing (2006) emphasized that computational thinking is a skill that everyone should have, we see that studies have been carried out for its integration into the school curriculum. In this context, we planned to carry out the relevant study in order to reveal the main trends and future capacity of the relevant field. In order to achieve



this aim, answers to the following questions were sought.

- 1) Who are the authors who publish the most in the field?
- 2) Which countries are the strongest in broadcast production?
- 3) What is the distribution of related publications by year?
- 4) What is the single-multiple authorship status of the publications?
- 5) What are the most used keywords in publications?
- 6) What are the most repeated keywords in the cited source publications?
- 7) What trend has the study subjects?
- 8) What are the subjects studied in the relevant field?
- 9) What is the distribution of the subjects studied?

METHOD

Bibliometric analysis is used to discover and analyze large volumes of scientific data for unlocking the evolutionary nuances of a particular field and to shed light on emerging fields in that field (Donthu, Kumar, Mukherjee, Pandey, and Lim, 2021). In this study, bibliometric analysis was used to present the state of the intellectual structure and emerging trends of computational thinking studies carried out using the unplugged approach in science education.

Data Collection

Bibliometric analysis of "unplugged" learning activities and computational thinking studies in science education on the Web of Science was carried out in order to emphasize the important, effective aspects, research flows, and themes in the literature, creating a knowledge base, and revealing scientific production. Using the keywords "Computational thinking" AND "science education" AND "(unplugged OR kinesthetic OR without computers)" to reach related publications, a total of 323 studies published between 2006-2022 were reached, and as a result of inclusion and exclusion criteria, 29 studies were included in the bibliometric analysis (Figure 1).

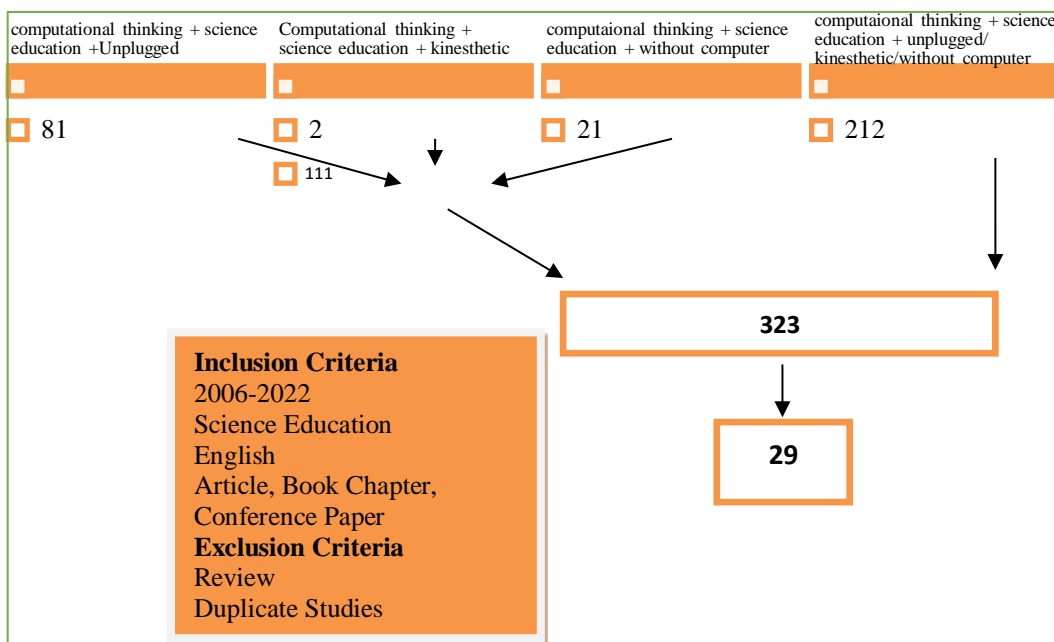

Figure 1. Data collection process on WoS

Data Analysis

The data set obtained through WoS was converted to bibtex format and transferred to the "biblioshiny for



bibliometrix" application, which is an R program tool running in RStudio Version (4.2.1). Developed by Massimo Aria, "biblioshiny for bibliometrix" is a java software and is a bibliometric analysis application that combines the functionality of the bibliometrix package with the ease of use of web applications using the Shiny package environment (Aria and Cuccurullo, 2017). The data obtained through the Biblioshiny program, the number of publications by authors, the countries of the authors, the number of citations received by the journals, the number of citations received by the sources, the number of publications according to the journals, the keyword cloud used in the publications, the keyword cloud used in the cited source publications. In addition, thematic mapping, factorial analysis, and trend topic analysis were also carried out.

RESULTS

In this section, the findings obtained in the bibliometric analysis are presented.

General Information

According to the figure 2 we can see that a total of 29 studies were carried out between 2013 and 2022. It has been determined that 15 of these publications are articles, 2 are book chapters, and 12 are conference proceedings.



Figure 2. Basic information for publications.

When the other parameters related to scientific publications in Figure 2 are examined; we may say that the annual average number of publications is 3 and the average number of citations per publication is 5.6. In addition, it was determined that the scientific publications in question were carried out by a total of 76 researchers. While 2 of these authors published their works with a single author, 74 of them published their works with multiple authors.

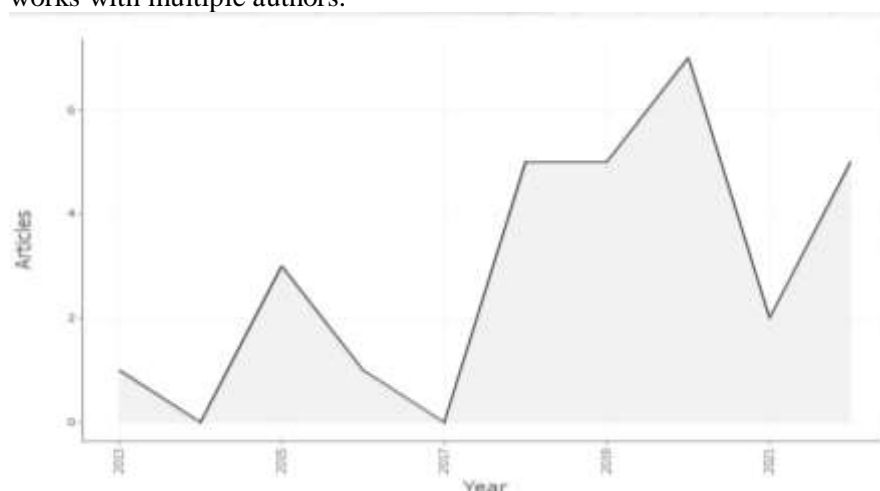

Figure 3. Distribution of Publications by Years

When Figure 3 is examined, it is seen that the publication rate of the analyzed studies increased rapidly as of



2017 but started to decrease after 2020. However, we may see that the number of studies tends to increase from 2021 onwards. In addition, it was determined that the rate of increase over the years was 19.58%.

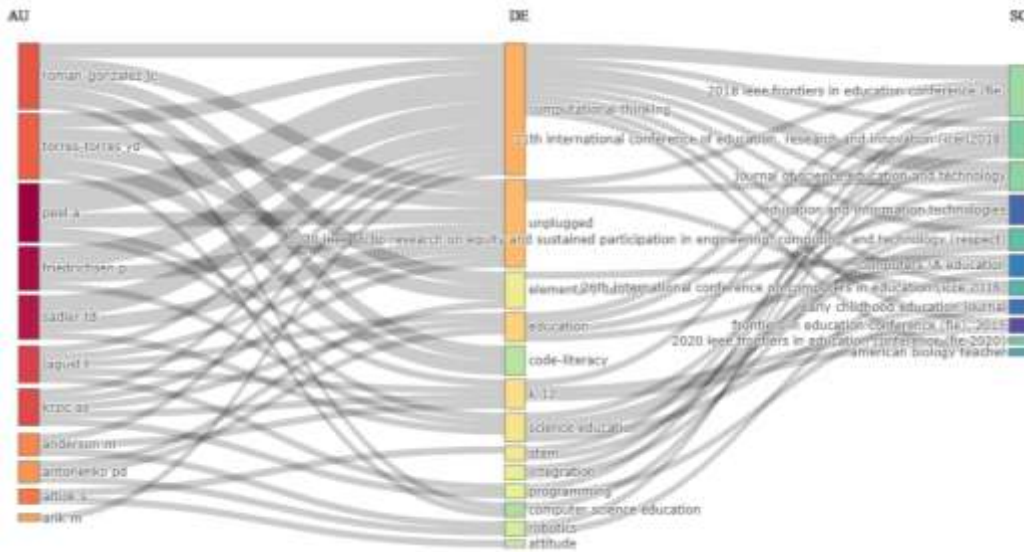

Figure 4. Representation of the Relationship Between Keywords, Authors, and Journals with Three Area Charts (Sankey Diagram)

The relationship between the keywords, the names of the authors, and the journals in which the studies were published is shown in Figure 4 on three area graphs. In the Sankey diagram, the journals in which the studies are published the most, the authors who contributed the most to these journals, and the keywords/themes most frequently used by the said authors are shown and the relationship between the variables is visualized with gray connection lines. The size of the rectangles in the chart; indicates that there are many publications associated with each of these items. To the left of the three area graphs is the first variable showing the names of the authors, and the names of 11 different authors are listed in this field. In addition, its relationship with the keyword in the middle of the graph is also visualized. Accordingly, the researchers who published the most were Roman-Gonzales J.C., Torres Y.D., Peel A., Friedrichsen P. and Sadler T.D. appears to be. It is striking that the study subjects/themes of the mentioned authors in relation to computational thinking in science education are "basic education", "unplugged learning approach" and "code writing". In addition, the most common keywords are "science education", "STEM", "integration", "programming", "robotics" and "attitude". Finally, in the right part of the three area graphs, 16 journals with the most publications of tourist guiding studies related to communication are listed. Accordingly, the most widely published source on the subject is the "2018 IEEE Frontiers in Education Conference", followed by the "11th annual International Conference of Education, Research and Innovation, ICERI 2018", "Journal of Science Education and Technology", "Education and Technology". Information Technologies” stands out as “Computers and Education”. When the relationship between the most published journals and the keywords/themes is evaluated, it is seen that the frequently used themes in the studies published in the "2018 IEEE Frontiers in Education Conference", which is the most published resource; It appears to be "computational thinking, unplugged, education and K-12".

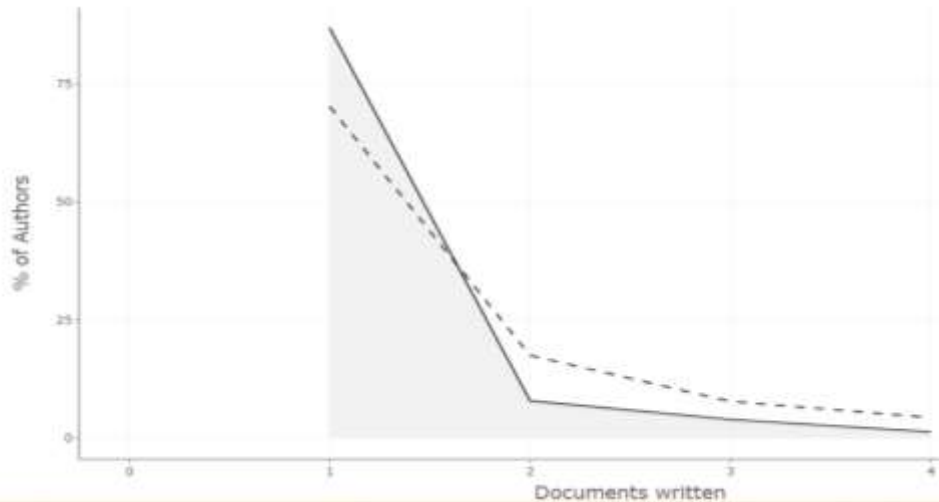

Figure 5. Distribution of Scientific Productivity by Lotka Law

According to Figure 5, it is seen that 86.8% of the researchers made only one publication, the rate of the authors who made two publications was 7.9%, and the remaining 5.2% of the researchers published 3 or more studies on the field. Lotka's law predicts that the ratio of researchers contributing to a field with a single publication to all publications should be 60%, the ratio of researchers contributing with 2 publications to those contributing with a single publication should be $\frac{1}{4}$, and the ratio of those contributing with 3 publications should be $\frac{1}{9}$ (Lotka, 1926). In this context, when evaluated according to Lotka's law, it is concluded that the relevant literature is insufficient and needs to be developed.



Figure 6. Most Relevant Resources for the Studies

Figure 6 shows the number of studies published by each journal in the dataset. A list with the names of the journals with the highest number of publications related to the subject and the circles shown in different colors next to them and the number of publications are shown. According to this, we can see that the range of publications is between 0 and 2, and the journal with the highest number of publications related to the field is "2018 IEEE Frontiers in Education Conference (FIE)" and "Journal Of Science Education and Technology" with the number of "2" publications. It is seen that there are 8 sources that publish the closest issue to the journals and that these journals also publish one publication each.

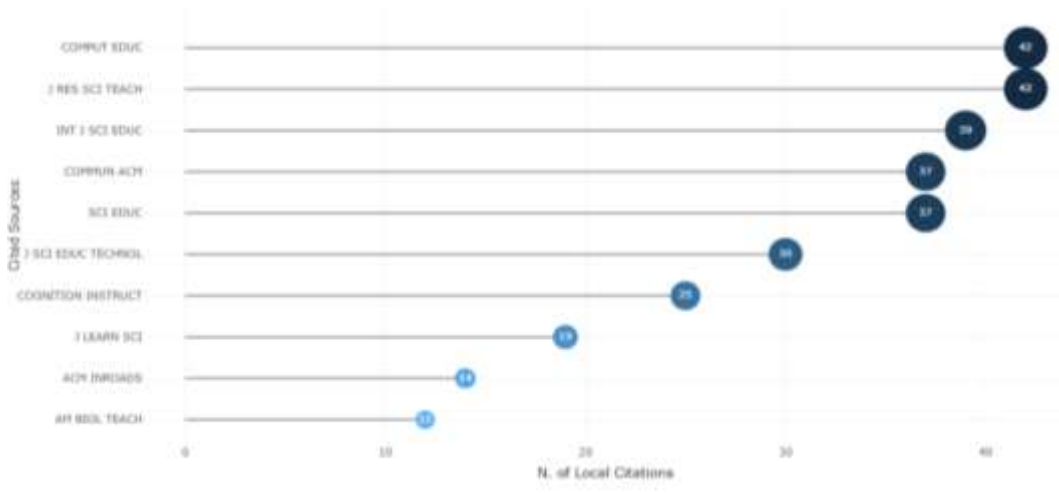

Figure 7. Most Local Cited Sources

The journals in which the reference studies referenced in the studies are published the most and the number of citations are shown in Figure 7. In the literature review of related studies, it is observed that the most referenced source journal is "Computers and Education" with 42 citations and "Journal of Research in Science Teaching", and the journal that closely follows named "International Journal of Science Education" with 39 citations. When the data in Figure 6 and Figure 7 are compared, we may say that the journals in which the computational thinking studies carried out with the unplugged approach in science education are mostly published and the journals in which the source publications are found differ in terms of order.

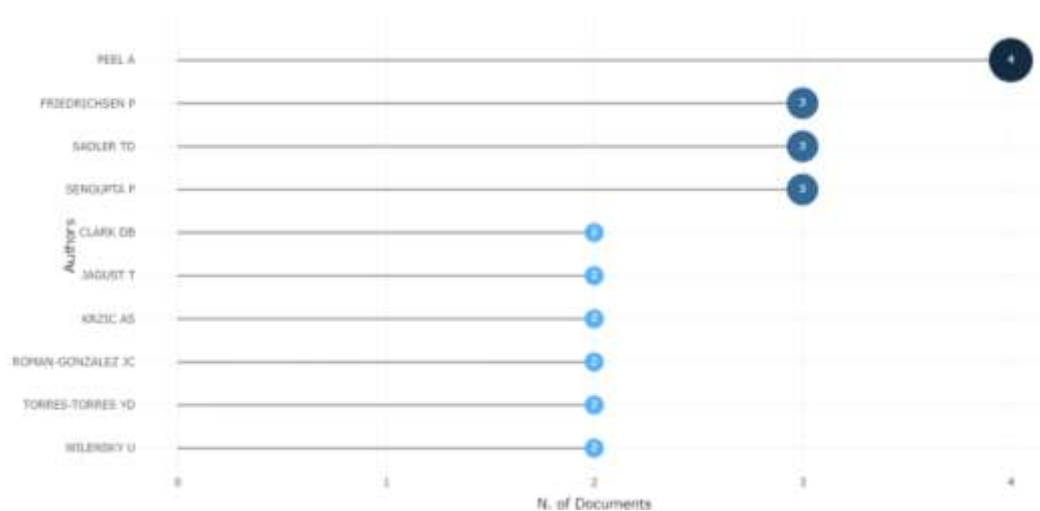

Figure 8. Most Relevant Authors

Figure 8 lists the 10 most relevant authors for analyzed studies. Accordingly, with 4 publications, Peel A. is the researcher who has published the most on the subject. In addition, it is seen that 3 researchers are in the top 10 with 3 published studies and 6 researchers with 2 published studies.

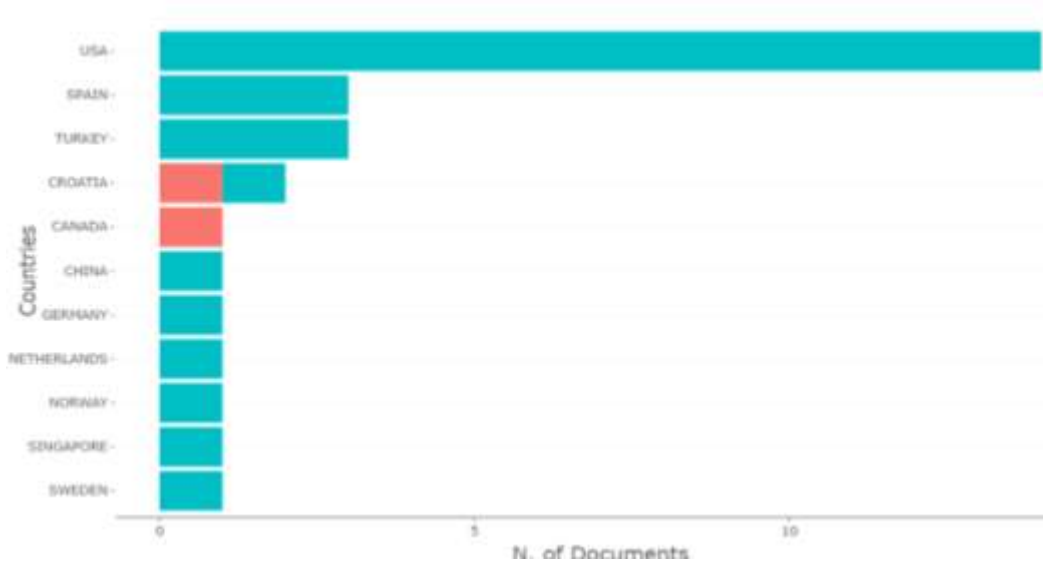

Figure 9. Distribution of Publications by Corresponding Author Countries

Figure 9 shows the publication distribution of the corresponding authors by country. In Figure 9, where the 11 countries with the highest number of publications are listed, it is seen that the number of publications of the countries is between 0 and 14. The USA, which is listed in the first place, has 14 studies, and the country that follows the most is Spain and Turkey with 3 publications each. In addition, it is seen on the chart that the bars expressing the number of publications are shown in two different colors. Among these colors, “red” refers to publications with authors from more than one country, and “turquoise” color refers to publications with author(s) from a single country. According to this, we may see that the countries with the highest number of studies prepared in cooperation with more than one country are Croatia and Canada.

computational thinking	18
unplugged	7
education	5
k-12	4
science education	4
stem	4
elementary education	3
integration	3
programming	3
robotics	3
attitude	2
code-literacy	2
computer science education	2
families	2
gender	2
natural selection	2
secondary students	2
teacher professional development	2
unplugged programming	2
agent-based models	1
algorithmic thinking	1
algorithms	1
approach	1
block-based coding	1

Figure 10. Comparison of Most Frequent Words in Keywords of Publications and Keywords of Source Publications

The keywords of the studies scanned in WoS and related publications cited in these studies and included in their bibliography are given in Figure 10. In the left column, 19 of the most frequently used keywords from 88 different keywords used in 29 studies published in journals scanned in WoS



are shown. In the right column, the keywords and frequency of use of the cited source publications are shown. According to Figure 10, the three most frequently used words in the 29 publications that are the subject of the study are "computational thinking" used 18 times, "unplugged" used 7 times and "education" used 6 times.



Figure 11. Keywords of the studies

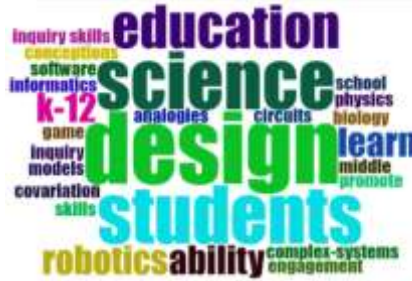

Figure 12. Keywords of source publications



Figure 13. Keywords of the titles



Figure 14. Keywords of abstracts



Word clouds showing how the keywords used in the studies are included in the bibliography, titles and abstracts are seen between Figures 11 and 14. Accordingly, we can see that the keywords used in computational thinking studies in which unplugged learning approach is used in science education focus on the integration of computational thinking into science content, secondary school students, STEM discipline and instructional design.

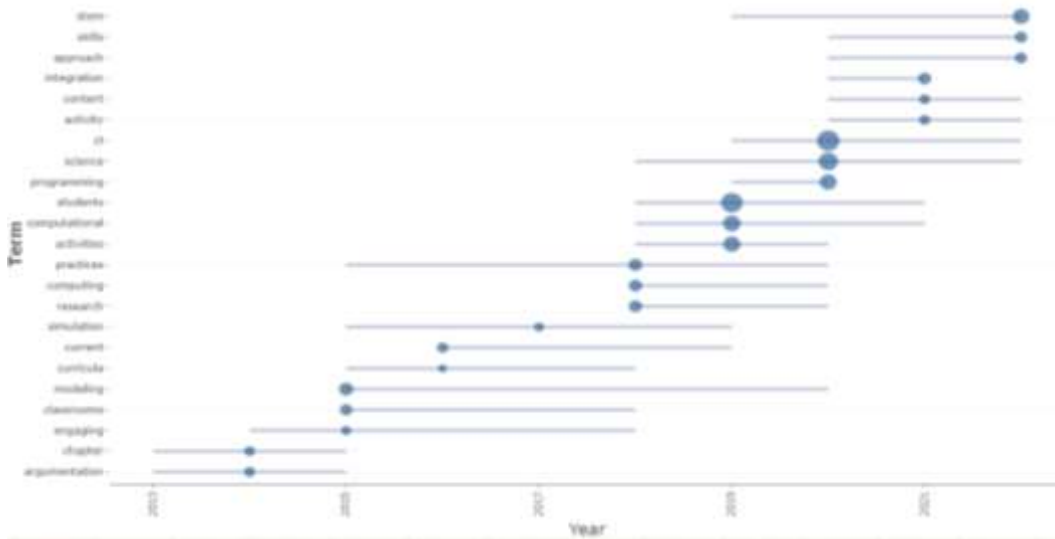

Figure 15. Trending Topics in Studies

The trend topic research topics by years are presented in Figure 15. It is seen that a total of 23 trend topic research topics were revealed for the studies published between 2013 and 2022 in the determination of trend topic topics. In addition, the circles shown on the graph represent the number of publications on the relevant subject, and the subjects with more publications are visualized with a larger circle. Accordingly, it is seen that the prominent topics are "computational thinking, science, programming, student and activity" between 2019-2020.

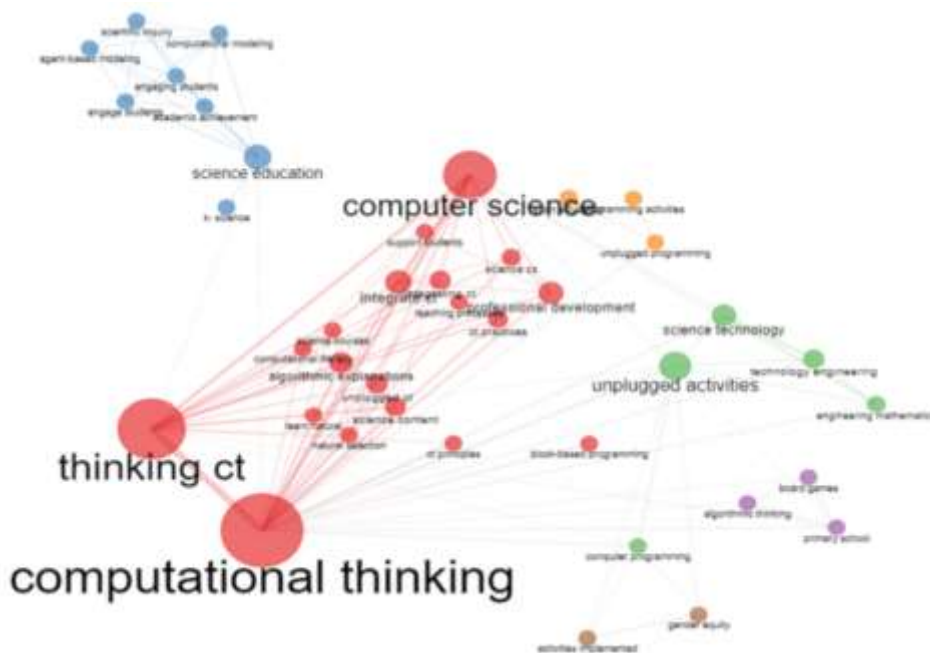

Figure 16. Co-Occurrence Network Analysis of the Studies



It is seen that 6 different clusters are formed according to the closeness of the keywords to each other. While the largest of these clusters is seen to be around the concepts of computational thinking, computer science and thinking ct, it is seen that the second largest cluster is concentrated around the concepts of unplugged activities, science technology, and engineering. We may see that the concepts clustered around science education are “academic achievement, engage students, computational modeling, scientific inquiry, agent-based modeling”.

Table 1. Most Cited Studies

Authors	Total Number of Citations	Total Citations Per Year
WILKERSON-JERDE M, 2015	29	"3,63"
"PEEL A, 2019"	24	"6,00"
"LUO F, 2020"	20	"6,67"
"LYTLE N, 2019"	17	"4,25"
"RICH KM, 2020"	15	"5,00"
OTTERBORN A, 2020	11	"3,67"

Table 1 includes the first 6 most cited studies worldwide, out of 29 published studies that are the subject of our study. It is seen that Wilkerson and Jerde (2015) "Exploring shifts in middle school learners' modeling activity while generating drawings, animations, and computational simulations of molecular diffusion" is the most cited work. In this study, during a workshop, 5 6th grade female students followed their practices while creating odor diffusion models using drawing, stop-motion animation, and computational simulation.

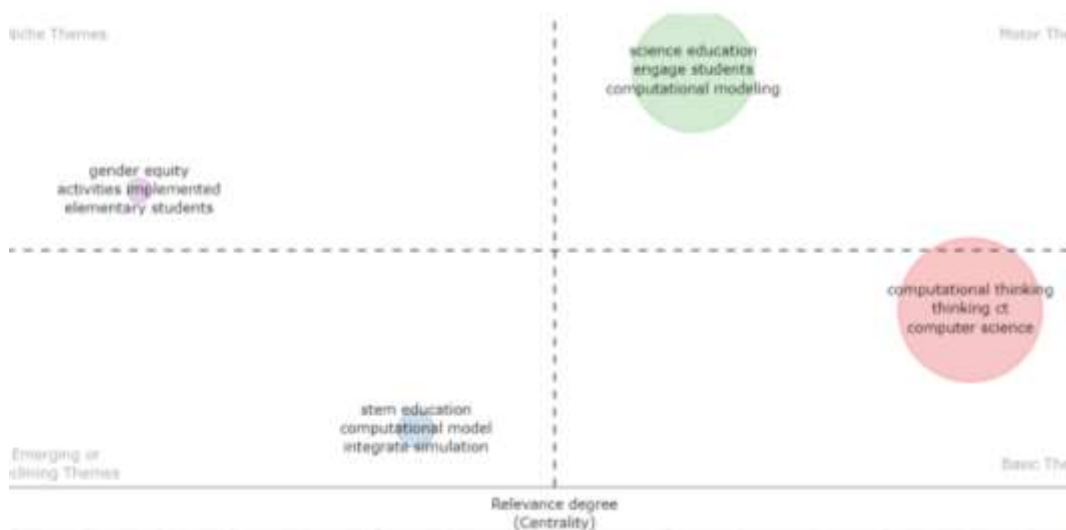

Figure 17. Thematic Map of the Studies

Figure 17 shows the thematic map of the studies included in the analysis. This map reveals the prevalence and centrality of the themes in the studies. Accordingly, it is seen that the motor themes of the studies examined are science education, integration of students and computational modelling. These themes emerge as the most common and central themes in the literature. It is seen that the niche themes are gender equality, activity implementation and secondary school students. Niche themes, on the other hand, appear as themes that are far from central, although they are widely studied. In the category of disappearing or emerging themes, it is seen that "STEM Education, computational model and integrate simulation". In the category of simple (basic) themes, it is seen that "computational thinking, thinking ct and computer science are included.

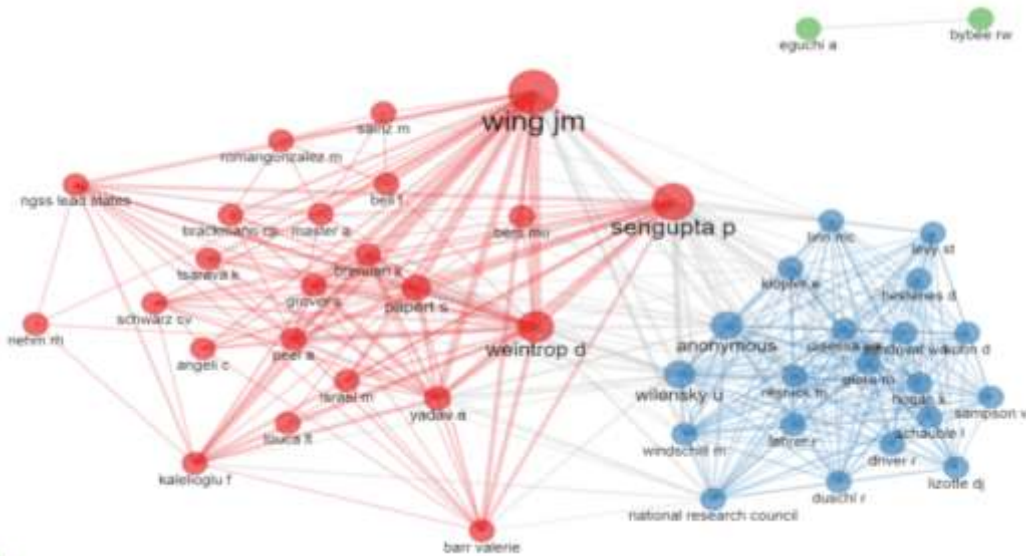

Figure 18. Co-Citation Network Analysis of the Studies

As seen in Figure 18, the most inspired and cited authors and their influence on each other can be seen. Accordingly, it is seen that the most affected author is Wing, and the second most affected author is Sengupta and third is Weintrop respectively.

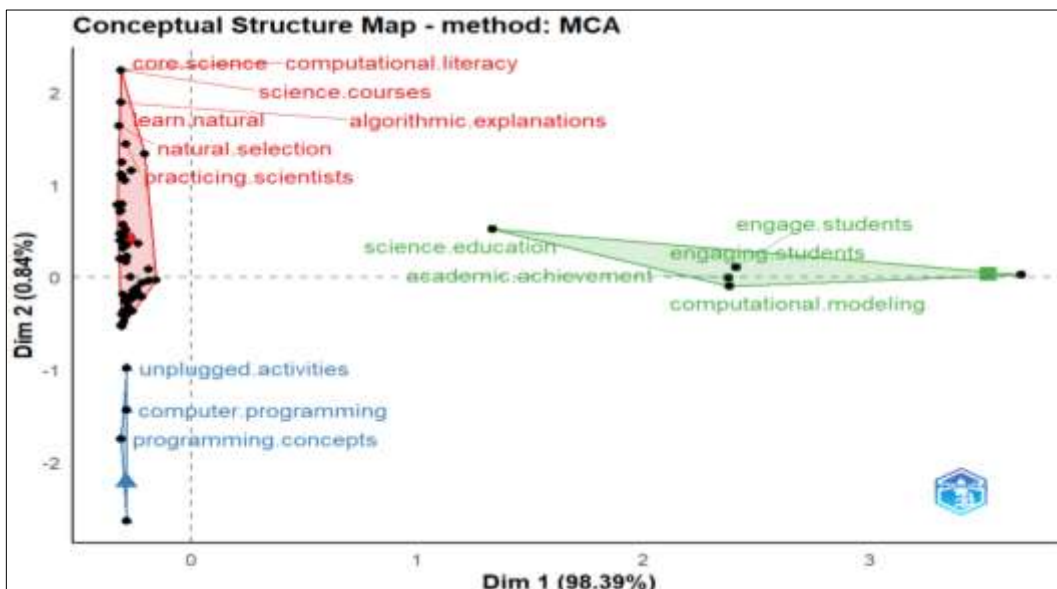

Figure 19. Factorial Analysis of the Studies

Factor analysis was carried out to reveal the conceptual structure of the studies. In this context, it is seen that three different factors have emerged. The first factor indicated in blue appears to be basic computer science and computational thinking concepts. It can be stated that the concepts indicated in red can be gathered under the factor of integration studies of computational thinking into science concepts. Under the third factor, it is seen that the focus is on learning products and processes.



CONCLUSION and DISCUSSION

In this study, which was carried out to reveal the general characteristics of the studies, a total of 29 studies published between 2006-2022 and accessed from the web of science (WoS) database managed by the Clarivate company were evaluated. We have been determined that almost all of the evaluated publications consist of articles and papers, and the studies in question were mostly written by more than one author. When the distribution of the related publications is analyzed by years, it is seen that the number of publications has increased between 2017-2020 and since 2021. When evaluated in terms of scientific productivity, we have been determined that almost all the researchers contributed to the literature with only one publication. When the unplugged learning approach and computational thinking studies in science education were evaluated according to Lotka's law (1926), it was concluded that the relevant literature was insufficient and needed to be developed. In addition, Özçınar (2017) states in his bibliometric study that computational thinking studies have an increasing trend in the field of education. When we look especially in terms of science education, although there are integration studies of computational thinking skills, it is seen that there is a need for integration to the curriculum, examining the strategies, methods, and techniques to be applied, and evaluation studies (Moreno-Leon et al., 2018).

When we evaluate the authors of the published studies in terms of countries, it is seen that the most publications originate from the USA. At the same time, it is striking that most of the studies have a single country author. Education is developed in different ways in different cultures and societies and is influenced by different cultures and societies in the globalizing world (Aras and Sözen, 2012). It is thought that the increase of interactions between countries within the framework of science education studies will have positive effects on computational thinking. It is seen that the sources with the highest number of publications are "2018 IEEE Frontiers In Education Conference (FIE)" and "Journal of Science Education And Technology" with 2 publications. The fact that the top 10 journals published only 1 study reveals once again that the number of researchers who published on unplugged learning approach and computational thinking in science education is insufficient. The fact that the literature is still in the development stage (Kıyıcı, 2022) can be cited as the reason for the insufficient publications. When the sources in which the most cited studies are published according to the sources, we may say that the journals in which the studies are published the most and the journals in which the source publications are found differ in terms of ranking. Since unplugged learning approach and computational thinking studies in science education were examined in our study, the publications of researchers with different fields of expertise were included in the research. For this reason, researchers prefer journals that publish according to their fields of expertise, but during the literature review, it has been determined that they are directed to journals that publish in the field of computer science. When the trending topics are examined, it is seen that there are "computational thinking, science, programming, student and activity" words between 2019-2020. It is seen that the simulation subject has left its place towards programming, especially between the years 2015-2017. Kıyıcı (2022) states that computers should be used as learning tools whose working system is understood in the learning-teaching environment. This situation also shows that the need for meeting the STEM workforce is shifting towards this field.

While the most frequently used keywords in the studies were "STEM", "unplugged", "education", "integration", robotics, K-12, programming; It is seen that the keywords frequently used in the cited source publications are words such as science, design, student and skill. In this context, it is seen that studies that deal with unplugged learning approach and computational thinking together in the field of science mostly focus on integration studies with students through programming and STEM subjects. Özçınar (2017) stated in his study that computational thinking studies will shift towards the STEM field and will attract attention in the future. According to the results of this study, it has been determined that computational thinking skills and unplugged learning approach studies in science



education focus on the integration of the curriculum, learning products and processes. The STEM field is still a trending field, but how it affects learning in terms of science-specific skills is predicted to be trending.

SUGGESTIONS

Many data obtained in the study support that the relevant field is a young research field, and it is recommended to increase the number of studies. Particularly, the collaboration of authors from different countries should be carried out to increase the widespread effect of the results in the field. Besides there is a need for experimental or mixed studies on curriculum, strategy, method and technique and evaluation for the integration of computational thinking into science education. In general, it is seen that studies focus on primary and secondary school levels. However, science education starts at a very young age (from the 1st grade, in our country from the 3rd grade) in many countries. It would be beneficial to increase the number of studies at these age levels. Researchers in science education should create their own theoretical and theoretical framework knowledge about computational thinking and unplugged strategy.

The results of this study are limited to the WoS database. To complete the results of the study researchers can use different databases such as Scopus and analyzes can be performed for the field of computational thinking may allow the structure and trends of the field to be revealed more clearly.

REFERENCES

- Abbott, B. P., Abbott, R., Abbott, T. D., Abernathy, M. R., Acernese, F., Ackley, K., ... & Chamberlin, S. J. (2016). GW151226: observation of gravitational waves from a 22-solar-mass binary black hole coalescence. *Physical review letters*, *116*(24), 241103.
- Aras, S., & Sözen, S. (2012). Türkiye, Finlandiya Ve Güney Kore’de Öğretmen Yetiştirme Programlarının İncelenmesi.
- Arik, M., & Topçu, M. S. (2022). Computational thinking integration into science classrooms: Example of digestive system. *Journal of Science Education and Technology*, *31*(1), 99-115.
- Acevedo-Borrega, J., Valverde-Berrocso, J., & Garrido-Arroyo, M. D. C. (2022). Computational Thinking and Educational Technology: A Scoping Review of the Literature. *Education Sciences*, *12*(1), 39.
- Aria, M., & Cuccurullo, C. (2017). bibliometrix: An R-tool for comprehensive science mapping analysis. *Journal of informetrics*, *11*(4), 959-975.
- Bell, T., Witten, I. H., & Fellows, M. (1998). *Computer Science Unplugged: Off-line activities and games for all ages*.
- Bell, T., Witten, I., & Fellows, M. (2015). *CS Unplugged: An enrichment and extension programme for primary-aged students*.
- Borrega, J., Valverde-Berrocso, J., & Garrido-Arroyo, M. D. C. (2022). Computational Thinking and Educational Technology: A Scoping Review of the Literature. *Education Sciences*, *12*(1), 39.
- Broadus, R. N. (1987). Toward a definition of “bibliometrics”. *Scientometrics*, *12*(5), 373-379.
- Donthu, N., Kumar, S., Mukherjee, D., Pandey, N., & Lim, W. M. (2021). How to conduct a bibliometric analysis: An overview and guidelines. *Journal of Business Research*, *133*, 285-296.
- Event Horizon Telescope Collaboration. (2019). First M87 event horizon telescope results. IV. Imaging the central supermassive black hole. arXiv preprint arXiv:1906.11241.
- Fraillon, J., Ainley, J., Schulz, W., Duckworth, D., & Friedman, T. (2019). IEA international computer and information literacy study 2018 assessment framework (p. 74). Springer Nature.



- Huang, W., & Looi, C. K. (2021). A critical review of literature on “unplugged” pedagogies in K-12 computer science and computational thinking education. *Computer Science Education*, 31(1), 83-111.
- Kakavas, P., & Ugolini, F. C. (2019). Computational thinking in primary education: A systematic literature review. *Research on Education and Media*, 11(2), 64-94.
- Kıyıcı, G. (2022). *Analysis of computational thinking research in science education: A meta-analysis study*. Doktora Tezi, Gazi Üniversitesi, 2022.
- Kite, V., & Park, S. (2022). Preparing inservice science teachers to bring unplugged computational thinking to their students. *Teaching and Teacher Education*, 120, 103904.
- Lapawi, N., & Husnin, H. (2020). Investigating Students’ Computational Thinking Skills on Matter Module. *International Journal of Advanced Computer Science and Applications*, 11(11).
- Lin, V., & Shaer, O. (2016, May). Beyond the lab: Using technology toys to engage South African youth in computational thinking. In *Proceedings of the 2016 CHI Conference Extended Abstracts on Human Factors in Computing Systems* (pp. 655-661).
- Lotka, A. J. (1926). The frequency distribution of scientific productivity. *Journal of the Washington Academy of Sciences*, 16(12), 317–324.
- Mensan, T., Osman, K., & Majid, N. A. A. (2020). Development and Validation of Unplugged Activity of Computational Thinking in Science Module to Integrate Computational Thinking in Primary Science Education. *Science Education International*, 31(2), 142-149.
- Moreno-León, J., Román-González, M., & Robles, G. (2018, April). On computational thinking as a universal skill: A review of the latest research on this ability. In 2018 IEEE Global Engineering Education Conference (EDUCON) (pp. 1684-1689). IEEE.
- Özçınar, H. (2017). Hesaplamalı düşünme araştırmalarının bibliyometrik analizi. *Eğitim Teknolojisi Kuram ve Uygulama*, 7(2), 149-171.
- Peel, A., Sadler, T. D., & Friedrichsen, P. (2019). Learning natural selection through computational thinking: Unplugged design of algorithmic explanations. *Journal of Research in Science Teaching*, 56(7), 983-1007.
- Peel, A., Sadler, T. D., & Friedrichsen, P. (2022). Algorithmic Explanations: an Unplugged Instructional Approach to Integrate Science and Computational Thinking. *Journal of Science Education and Technology*, 1-14.
- Pritchard, R. D. (1969). Equity theory: A review and critique. *Organizational behavior and human performance*, 4(2), 176-211.
- Seow, P., Looi, C. K., How, M. L., Wadhwa, B., & Wu, L. K. (2019). Educational policy and implementation of computational thinking and programming: Case study of Singapore. In *Computational thinking education* (pp. 345-361). Springer, Singapore.
- Unnikrishnan, R., Amrita, N., Muir, A., & Rao, B. (2016, June). Of elephants and nested loops: How to introduce computing to youth in rural India. In *Proceedings of the The 15th International Conference on Interaction Design and Children* (pp. 137-146).
- Wing, J. M. (2006). Computational thinking. *Communications of the ACM*, 49(3), 33-35.
- Yildiz, M., & Karal, H. (2021). A Computer Science Unplugged Activity: CityMap. *International Journal of Computer Science Education in Schools*, 5(2), 14-27.



DESIGN, IMPLEMENTATION AND EVALUATION OF A WEB 2.0 TOOL IN TEACHING SOCIO-SCIENTIFIC SUBJECTS: OCTOPUS

Erol Taş

Tülin Hündür

Meral Çelikoğlu

H. Mehmet Yeşiltaş

Ordu Üniversitesi, Eğitim Fakültesi, Fen Bilgisi Eğitimi, Ordu, Türkiye.

Abstract

The main purpose of this research is to develop a new tool for the teaching of socio-scientific concepts in the subject of biotechnology and to examine the effect on the academic success of pre-service science teachers. In this study, we used quasi-experimental research method, which is one of the quantitative research methods. The study group was determined by simple random sampling method and consisted of 33 science teacher candidates. The biotechnology achievement test developed by Taş, Hündür, Çelikoğlu and Yeşiltaş (2022) was used as a data collection tool and to measure the effect of the related tool on success. The 8 arms of the octopus, designed with Vitamin factory, an EBA content development program, are divided into four groups as white, blue, red and green in pairs according to their colors. In each arm, there are questions according to the determined themes (basic concepts, positive aspects, negative aspects, and future implications), and if these questions are answered incorrectly, there are activities designed to eliminate the participant's misconceptions also. SPSS 22.0 analysis program was used in the analysis of the data obtained, and Shapiro Wilk normality test, independent samples t test, dependent samples t test analyzes were performed for data analysis. According to the results obtained, we determined that the Octopus tool increased the success of the students in the experimental group on the basis of average points, but this situation was not significant. Recommendations for the development and modification of the Octopus tool are presented and in addition, suggestions were shared with the researchers about the issues to be considered in such studies.

Keywords: Socio-scientific issues, concept teaching, biotechnology, Octopus

INTRODUCTION

As a result of dynamic relations in society and scientific developments, “Socioscientific issues” have emerged (Yeniceli and Hastürk, 2021). Socioscientific issues are discussed both from a social and scientific point of view and expressed as complex, contradictory, unanswered and generally controversial issues (Aydın and Mocan, 2019; Caymaz, 2020). Common features of socio-scientific issues in science education are (1) the use of a complex, socially relevant topic as the main theme; (2) students' participation in higher-order thinking processes, (3) drawing attention to the scientific and social dimensions of the subject (Sadler, Romine and Topçu, 2016). They are often seen as controversial issues in society but require some degree of moral judgment or consideration of ethical concerns in the process of reaching decisions about possible solutions to these problems (Zeidler and Nichols, 2009). On the other hand, the aim of many science teaching programs was to introduce teachers to moral and ethical issues related to biotechnological developments. However, this topic is still something new to most teachers, and although they appreciate this new field of knowledge added to the curriculum, they have some reservations about handling controversial topics in science



classes (Gray and Bryce, 2006). In addition to the fact that socioscientific issues, and in particular biotechnology, are complicated by the constant updating, when the inadequate infrastructure of pre-service teachers on this subject is considered, the subject becomes more difficult for students to understand and mislearning can occur (Hasançebi and Konak, 2021). Besides it's take the time for teachers to come up with scientific data sources and perspectives that are both reliable and potentially invalid so that students can encounter mixed evidence and learn to evaluate the validity of various claims and data (Zeidler and Nichols, 2009). Both in our country and in different countries, there are difficulties in the conceptual learning of socioscientific issues (Türkmen and Darçın, 2007; Sorgo, Dolinsek, Usak, and Özel, 2011; Duda, Wahyuni, and Setyawan, 2020), and teachers and students have problems in the level of conceptual knowledge about some biotechnology studies such as the production of genetically modified organisms (GMO), DNA fingerprinting, cloning, and traditional breeding (Semenderoğlu and Aydın, 2014; Sıcaker and Oz Aydın, 2015). The results of the observations in the schools showed that the students learn biotechnology through theories for students to memorize (Nurtamara, and Prasetyanti, 2020). Teachers ' mastery of biotechnology is effective in increasing their level of knowledge and developing positive attitudes, and their students making healthy decisions on these issues. For this reason, the correct learning of the subject and applications of biotechnology plays an effective role in eliminating the misconceptions of both teachers and students (Aydın and Mocan, 2019; Hasançebi and Konak, 2021).

In this study, biotechnology was chosen since it is one of the important issues that affect the society to a large extent, as well as having a controversial and contradictory content that affects the society. In addition, it is seen that the importance of eliminating the misconceptions of pre-service science teachers who will teach these subjects to their students on the concepts of biotechnology is emphasized in the literature. Therefore, the main purpose of this research is to develop a new tool for teaching concepts specific to the subject of biotechnology under the title of socioscientific issues and to examine the effect of this tool on the academic achievement of pre-service science teachers. For this purpose, answers to the following research questions were sought;

1. Is there a significant difference between the biotechnology achievement test pre-test and post-test mean scores of the science teacher candidates in the control group where the traditional teaching method was applied?
2. Is there a significant difference between the biotechnology achievement test pre-test and post-test mean scores of science teacher candidates in the experimental group to which the Octopus tool was applied?
3. Is there a significant difference between the biotechnology achievement test post-test mean scores of the pre-service science teachers in the experimental group to which the Octopus tool was applied and the concept achievement test post-test mean scores of the pre-service science teachers in the control group where the traditional teaching method was applied?

METHOD

In this study, a quasi-experimental design with pre-test post-test control group was conducted from the quantitative research methods. The aim in the quasi-experimental method is to present the difference that may occur between the variables in cause and effect (Creswell, 2017).

Study Group

The study group of the research was determined by simple random sampling method and 33 preservice science teachers were studied.



Data Collection Tool

The biotechnology achievement test developed by Taş et al. (2022) was used as a data collection tool in the study. The achievement test consists of 39 items and the KR 20 reliability coefficient was calculated as 0.70 in the pilot application of the test. In this study, after the implementation of the test, the KR 20 reliability coefficient of the biotechnology achievement test was calculated as 0.78.

Design Idea of OCTOPUS

When we look at the literature (Ratcliffe and Grace, 2003; Zeidler and Nichols, 2009; Topçu, Muğaloğlu and Güven, 2014; Türkmen, Türkmen, Pekmez and Sağlam, 2017) it is seen that socioscientific issues are controversial. It is seen that socio-scientific issues such as biotechnology are handled from four different perspectives, especially within the scope of our science curriculum (MoNE, 2018). These are the basic concepts, positive aspects, negative aspects, and future applications of the socio-scientific concept. In this study, we aimed to design a tool that can accommodate all different aspects together within the framework of the constructivist approach.

Structure of OCTOPUS

In nature the octopus has eight arms in total. In this design, 4 basic units are formed by dividing 8 arms into 2 according to the viewpoints (basic concepts, positive aspects, negative aspects, and future applications). A different colour is determined for each unit. Accordingly, the blue arm represents the " positive aspects ", the red arm represents the " negative aspects ", the white arm represents the "basic definitions " and the green arm represents the "future applications ". One of the two arms has questions and options, while the other has activities (Figure 1).

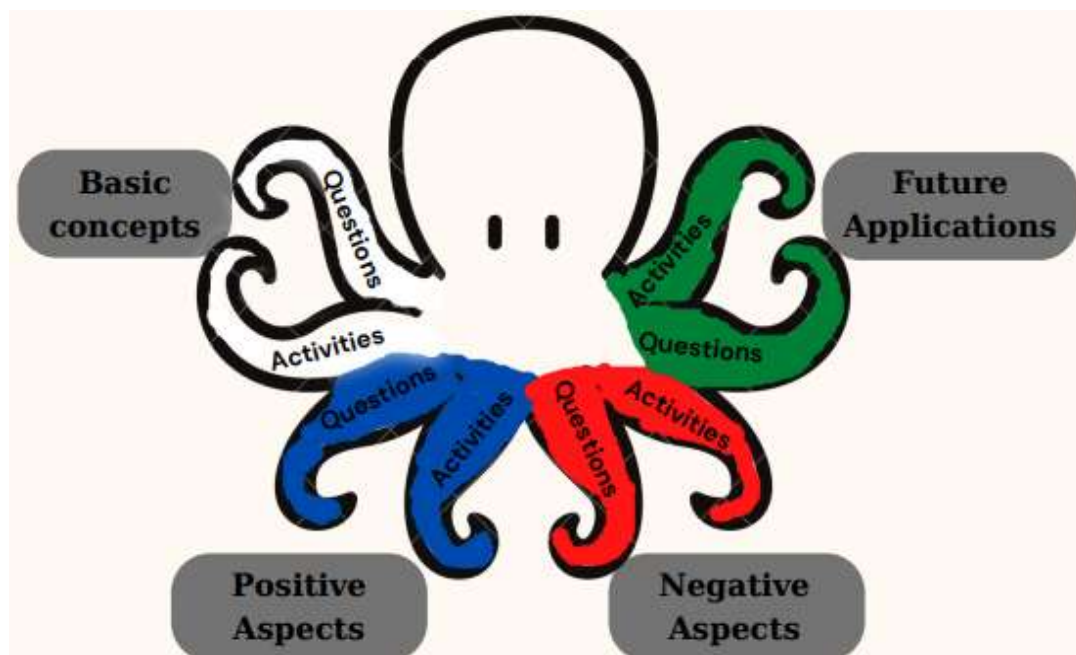

Figure 1. OCTOPUS Tool



Content Creation Process

The content was prepared based on the biology III course, which is a 2nd year course that includes biotechnology subjects at Ordu University Education Faculty. Within the scope of the course, the related literature on gene cloning, GMO, cloning, DNA fingerprinting, biotechnology, traditional breeding, biomimicry for the Octopus tool was reviewed and misconceptions were identified. In this direction, questions and activities were prepared.

Limitations of the Research

The research was carried out to eliminate the misconceptions within the framework of the subject of biotechnology, which is among the socioscientific issues. For this reason, this study, which is limited to concept teaching, has been prepared in accordance with certain concepts.

Validity and Reliability

Opinions of a biologist, science educator and computer and instructional technology expert were taken in terms of the suitability of the content created in the study. All stages of the research were arranged in accordance with the mixed method research and the process was explained in detail.

Implementation Phase

For the application of the Octopus, a 3-day practice was organized with the pre-service science teachers. To prevent pre-service teachers from being exposed to a very intense content, basic concepts and positive perspective questions and activities were applied on the 1st day, while questions and activities related to the negative perspective were applied on the 2nd day. On the third day, questions and activities regarding future applications took place. The average duration of the 3-day application is 38 minutes per day. The questions and activities for each section were shared with the preservice science teachers on the same day just before the application. They accessed the content of the created web 2.0 tool via <http://kekremisi.com/ahtapot5/output/dataLevel.html> address.



An example of an activity for the positive case with the Octopus tool is given in figure 2.

BIOTECHNOLOGY POSITIVE ASPECT SCENARIO

I believe that biotechnological products will bring solutions to many global problems seen all over the world with the increase in population.

YES
NO

Where did you learn about this topic?.





<p>Can you tick the option or options that you believe biotechnology can be a solution to current global problems? With biotechnology studies, genetic diseases in humans can be detected and treated. <input checked="" type="checkbox"/> Plants resistant to harsh climatic changes can be produced. <input type="checkbox"/> When transferring the characteristics of one living thing to another, new features that we do not know may emerge. <input type="checkbox"/> Human cloning is possible. <input checked="" type="checkbox"/> Extension of shelf life of vegetables and fruits <input checked="" type="checkbox"/> The use of bacteria in the treatment of polluted water <input checked="" type="checkbox"/> The taste, nutritional value and overseas durability in the process of marketing to countries augmented by genetic modification <input checked="" type="checkbox"/> use in solving forensic cases <input checked="" type="checkbox"/> Making clones of living things in danger of extinction <input type="checkbox"/> Positive effects of genetically modified foods on human health.</p>	 <p>TURK HEMATOLOJİSİ EKİMİ Kan yetiştirme proteini ameliyatları insan genetik kayıtları bu süreçte keçi ağızları kullanılmaktadır.</p>
<p>BİYOTEKNOLOJİNİN YARARLARI</p> 	<p>Can you tick the option or options that you believe biotechnology can be a solution to current global problems? With biotechnology studies, genetic diseases in humans can be detected and treated. <input checked="" type="checkbox"/> Plants resistant to harsh climatic changes can be produced. <input type="checkbox"/> When transferring the characteristics of one living thing to another, new features that we do not know may emerge. <input type="checkbox"/> Human cloning is possible. <input checked="" type="checkbox"/> Extension of shelf life of vegetables and fruits <input checked="" type="checkbox"/> The use of bacteria in the treatment of polluted water <input checked="" type="checkbox"/> The taste, nutritional value and overseas durability in the process of marketing to countries augmented by genetic modification <input checked="" type="checkbox"/> use in solving forensic cases <input checked="" type="checkbox"/> Making clones of living things in danger of extinction <input type="checkbox"/> Positive effects of genetically modified foods on human health.</p>
	

Figure 2. Sample questions and activities for one arm of the OCTOPUS tool (biotechnology positive aspect scenario)

As seen in the figure 2, there is activity for a subject (benefits of biotechnology) in one of the 4 basic units in the arms of the octopus. At the beginning of this activity, a basic question is asked on the subject and two options for the answer to the question appear. If all options in the question are answered correctly, other questions and activities are migrated. If any of the options is incorrectly selected, the student is provided with a transition to the concept change text (Different concept teaching tools were also used in different questions. For example, fishbone or diagnostic branched tree). If participant gives a true answer, there are more than one selectable option related to the question, but if the question is answered negatively, it is immediately directed to the activity part of the Octopus. After the activity part, it is foreseen that the subject can be taught without misconception by directing the questions to get a true answer again and with a different activity (Figure 3).

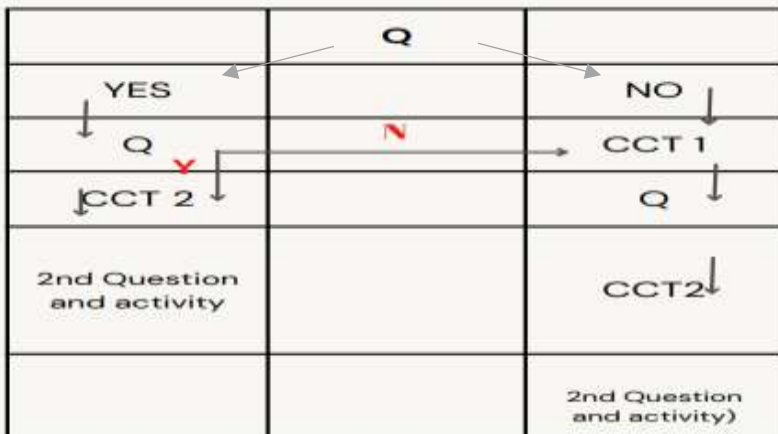

Figure 3. Octopus digital flow chart



RESULTS

Before starting to investigate the effects of the chosen subject on the teaching of socio-scientific concepts on biotechnology on the teaching, it was aimed to see whether there was any difference in terms of information between the experimental and control groups. For this, pre-test was applied to both groups. The results of the analysis applied to determine whether the difference between the descriptive analyzes of the scores received by the groups as a result of the preliminary test is significant are given in Table 1. Firstly, we analysed the normal distribution of the data. For this purpose, Shapiro-Wilk normality test was applied.

Table 1. Biotechnology Achievement Test Shapiro-Wilk normality test results.

	Statistic	sd	p
Biotechnology Achievement Test	0,984	33	0,902

As seen in Table 1, the data show a normal distribution. As a result of the analysis, $p=0.902$ was found and since ($p > 0.05$), it was determined that there was no difference between the experimental group and the control group in terms of pre-test scores. It is seen that the pre-knowledge of the students in both groups about the subject of "biotechnology" is equivalent to each other. Thus, it is thought that the students are at the same level, and the post-test scores obtained from the students after the application will vary according to the application of the developed tool. The results of the independent samples t-test of the pre-test scores of the pre-service science teachers belonging to the biotechnology achievement test are shown in Table 2.

Table 2. Biotechnology Achievement Test pre-test results of control and experimental groups

	N	X	S	sd	t	p
Control Group	16	26,0500	3,7771	31	1,959	0,60
Experimental Group	17	23,3526	4,5544			

According to the pre-test results of the biotechnology achievement test of the pre-service teachers, there is no significant difference between the groups ($p > 0.05$). The scores of the pre-service teachers in the control group from the biotechnology achievement test ($X=26,050$) were higher than the scores of the pre-service teachers in the experimental group ($X=23.352$). The biotechnology achievement test pre-post-test dependent samples t-test results of the pre-service teachers in the control group are shown in Table 3.

Table 3. Biotechnology Achievement Test pre-post test results of control group

	N	X	S	sd	t	p
Pre-Test	16	26,00	0,944	15	2,236	0,041
Post-Test	17	29,00	1,204			

It was found that there was a significant increase in the pre-post test scores of the pre-service teachers in the control group ($p < 0.05$). The biotechnology achievement test pre/post-test dependent samples t-test results of the pre-service teachers in the experimental group are shown in Table 4.

Table 4. Biotechnology Achievement Test pre-post test results of experimental group

	N	X	S	sd	t	p
Pre-Test	17	23,3529	1,104	16	1,985	0,065
Post-Test	17	26,058	0,897			

There was no significant increase in the pre-post test scores of the pre-service teachers in the experimental group in the biotechnology achievement test ($p > 0.05$). However, it was concluded that the post-test scores ($X=26,058$) of the preservice science teachers in the experimental group were



higher than the pre-test scores ($X=23,352$). The independent samples t-test results of the pre-test scores of the preservice science teachers belonging to the biotechnology achievement test are shown in Table 5.

Table 5. Biotechnology Achievement Test post test results of control and experimental groups

	N	X	S	sd	t	p
Control Group	16	29,000	4,8166	31	1,81	0,78
Experimental Group	17	26,058	3,6991			

According to the pre-test results of the biotechnology achievement test of the pre-service teachers, there is no significant difference between the groups ($P>0.05$). The scores of the pre-service teachers in the control group ($X=29.0$) were higher than the scores of the preservice teachers in the experimental group ($X=26.058$).

CONCLUSION

The Octopus web 2.0 tool is a tool that combines different perspectives on the subject of biotechnology and aims to teach socioscientific concepts and eliminate misconceptions on this subject. However, the first application results show that the Octopus Web 2.0 tool needs to be developed and changed. Possible reasons for this situation are thought to be:

Although there was no significant difference between the pre-test results of the groups, the experimental group students were selected from the students with low achievement level. It makes us think that the selection of students with a score of 25 or less in the experimental group may have caused this situation. Homogeneous grouping may have made it difficult to measure the effect of the relevant instrument also. Estrada-Lizárraga, Zaldívar-Colado, Peraza-Garzón, Nava-Pérez, Cobián-Campos and Orozco-Cárdenas (2012) found that the tool used in their study on the use of moodle and web 2.0 tools in higher education did not significantly increase the academic achievement, and they state that it is due to the higher homogeneity of the group, that is, there is not much distribution towards subclasses as in the control group.

There were some technical problems during the implementation. The application was not opened on the computers of some students, or the planned activity could not be started. In such cases, it is thought to affect the achievement of the desired result. Özen and Mazman Akar (2022) stated that in their study where they examined the online teaching experiences of pre-service teachers, they evaluated technical failures in the category of negative experience, while Başaran, Doğan, Karaoğlu and Şahin (2020) stated that technical failures had a negative impact on success and learning.

We think that the implementation may have been too intense for preservice science teachers. Although it was not measured due to the lack of intensive content of the prepared content, it is estimated that it may have increased the cognitive load of the pre-service science teachers. Cognitive load is divided into three types, namely intrinsic load, germane/effective load, and extraneous load (Sweller, Ayres and Kalyuga, 2011; Sweller, van Merriënboer, and Paas, 1998). Extraneous load is directly related to instructional materials and presenting and designing instruction. As a result of intensive designed instructional materials and instruction, active memory may load comprises irrelevant cognitive load (Reiser and Dempsey, 2007).

We think that motivation levels of students may have prevented the measurement of the effect of the related web 2.0 tool. Because in many studies in the literature, the importance of the relationship between motivation and success has been emphasized. Alkan and Bayri (2017) state that motivation



is effective in increasing success in science education in their study called A Meta-Analysis Study on the Relationship Between Motivation for Science Learning and Science Achievement.

SUGGESTIONS

Since the octopus web 2.0 tool increased the post-test scores of the experimental group, we think that its use with some changes and developments would be appropriate in the teaching of socioscientific subjects such as biotechnology. For this reason, we can say that it is necessary to take measures to ensure within-group heterogeneity, homogeneity between groups, to correct the necessary technical problems, reorganizing the implementation environment and to simplify the content. It is recommended that all researchers pay attention to such factors in their educational tool development processes.

REFERENCES

- Alkan, İ., Alkan, İ., & Bayri, N. (2017). Fen Öğrenmeye Yönelik Motivasyon ile Fen Başarısı Arasındaki İlişki Üzerine Bir Meta Analiz Çalışması. *Dicle Üniversitesi Ziya Gökalp Eğitim Fakültesi Dergisi*, (32), 865-874.
- Aydın, E., & Mocan, D. K. (2019). Türkiye’de Düünden Bugüne Sosyobilimsel Konular: Bir Doküman Analizi. *Anadolu Öğretmen Dergisi*, 3(2), 184-197.
- Başaran, M., Doğan, E., Karaoğlu, E., & ŞAHİN, E. (2020). Koronavirüs (Covid-19) pandemi sürecinin getirisi olan uzaktan eğitimin etkililiği üzerine bir çalışma. *Academia Eğitim Araştırmaları Dergisi*, 5(2), 368-397.
- Caymaz, B. (2020). Fen Bilimleri Öğretmenlerinin Sosyo-bilimsel Konular Hakkındaki Tutumlarının İncelenmesi. *Anadolu Öğretmen Dergisi*, 4(2), 226-242.
- Creswell, J. W., & Creswell, J. D. (2017). Research design: Qualitative, quantitative, and mixed methods approaches. Sage publications.
- Duda, H. J., Wahyuni, F. R. E., & Setyawan, A. E. (2020). Student Misconception Analysis In The Biotechnology Concept Withcertainty Of Response Index. *International Journal of Education Humanities and Social Science*, 3(1), p.110-121.
- Estrada-Lizárraga, R., Zaldívar-Colado, A., Peraza-Garzón, J. F., Nava-Pérez, L., Cobián-Campos, J. A., & Orozco-Cárdenas, H. (2012). Impact of moodle educational platform and the tools of web 2.0, with an approach based on blended learning on students in higher education. In *EDULEARN12 Proceedings* (pp. 2482-2490). IATED.
- Gray, D. S., & Bryce, T. (2006). Socio-scientific issues in science education: implications for the professional development of teachers. *Cambridge Journal of education*, 36(2), 171-192.
- Konak, M. A., & Hasançebi, S. (2021). Biyoloji Öğretmenlerinin Biyoteknoloji ve Uygulamalarına Yönelik Bilgi Ve Tutumlarının Değerlendirilmesi. *Journal Of Instructional Technologies and Teacher Education*, 10(1), 1-15.
- MEB. (2018). İlköğretim kurumları fen bilimleri dersi öğretim programı. Ankara: Talim ve Terbiye Kurulu Başkanlığı.
- Nurtamara, L., & Prasetyanti, N. M. (2020). The Effect of Biotechnology Module with Problem Based Learning in the Socioscientific Context to Enhance Students' Socioscientific Decision Making Skills. *International Education Studies*, 13(1), 11-20.
- Özen, S. O., & Akar, S. G. M. Öğretmen Adaylarının Çevrimiçi Eğitimlik Deneyimlerinin İncelenmesi. *Muğla Sıtkı Koçman Üniversitesi Eğitim Fakültesi Dergisi*, 9(2), 585-600.
- Ratcliffe, M., & Grace, M. (2003). *Science education for citizenship: Teaching socio-scientific issues*. McGraw-Hill Education (UK).



- Sadler, T. D., Romine, W. L., & Topçu, M. S. (2016). Learning science content through socio-scientific issues-based instruction: A multi-level assessment study. *International Journal of Science Education*, 38(10), 1622-1635.
- Semenderoğlu, F., & Aydın, H. (2014). Öğrencilerin Biyoteknoloji ve Genetik Mühendisliği Konularını Kavramsal Anlamalarına Yapılandırıcı Yaklaşımın Etkisi. *Electronic Turkish Studies*, 9(8).
- Sıcaker, A., & Aydın, S. Ö. (2015). Ortaöğretim Biyoteknoloji ve Gen Mühendisliği Kavramlarının Öğrenciler Tarafından Değerlendirilmesi. *Ondokuz Mayıs University Journal of Education Faculty*, 34(2), 51-67.
- Sorgo, A., Ambrozic-Dolinsek, J., Usak, M., & Özel, M. (2011). Knowledge about and acceptance of genetically modified organisms among pre-service teachers: A comparative study of Turkey and Slovenia. *Electronic journal of biotechnology*, 14(4), 5-5.
- Sweller, J., Ayres, P., & Kalyuga, S. (2011). Measuring cognitive load. In *Cognitive load theory* (pp. 71-85). Springer, New York, NY.
- Sweller, J., Van Merriënboer, J. J., & Paas, F. G. (1998). Cognitive architecture and instructional design. *Educational psychology review*, 10(3), 251-296.
- Taş, E., Hündür, T., Çelikoğlu, M. & Yeşiltaş, H. M. (2022). Development Of Biotechnology Achievement Test For Science Teachers. *III. Karabagh International Congress Of Modern Studies In Social And Human Sciences to be held in Karabagh, Azerbaijan, June7-10, 2022.*
- Topcu, M. S., Muğaloğlu, E. Z., & Güven, D. (2014). Socioscientific issues in science education: The case of Turkey. *Educational Sciences: Theory & Practice*, 14(6).
- Türkmen, H., Pekmez, E., & Sağlam, M. (2017). Pre-service science teachers' thoughts about socio-scientific issues. *Ege Journal of Education*, 18(2), 448-475.
- Turkmen, L., & Darcin, E. S. (2007). A Comparative Study of Turkish Elementary and Science Education Major Students' Knowledge Levels at the Popular Biotechnological Issues. *International Journal of Environmental and Science Education*, 2(4), 125-131.
- Yeniceli, M., & Hastürk, G. (2021). Öğretmen Adaylarının Sosyobilimsel Konulara İlişkin Tutumlarının İncelenmesi. *Anadolu Öğretmen Dergisi*, 5(1), 160-178.
- Zeidler, D. L., & Nichols, B. H. (2009). Socioscientific issues: Theory and practice. *Journal of elementary science education*, 21(2), 49-58.



**LOCAL GOVERNANCE AND CLIMATE CHANGE MITIGATION IN YEWA SOUTH
LOCAL GOVERNMENT AREA, NIGERIA.**

Wasiu Abiodun Makinde

Department of Public Administration, the Federal Polytechnic, Ilaro, Ogun State, Nigeria

Abstract

Globally, the threat of climate change to humanity cannot be over emphasised. Mitigation of its effect and threat requires social actions and solutions from all citizens, individually and in groups. This study examines the effort of local governance structures on the mitigation of climate change in Yewa South Local Government Area, Nigeria. The study adopted a descriptive survey research design through questionnaire administration. The population of the study comprised of 183 traditional council members and 253 executives of registered Community Development Association (CDAs) in Yewa South Local Government, Nigeria. The study adopted a simple random sampling technique to select 218 respondents for questionnaire administration purpose and three (3) respondents in each category for in-depth interview to elicit information on local governance efforts in mitigating climate change in Yewa South Local Government Area, Nigeria. Data collected were analysed through descriptive statistics and regression analysis at 0.05 level of significance. The study revealed that there is a significant effort of local governance on climate change mitigation in Yewa South Local Government, Nigeria. It recommends for support of all levels of government to improve mitigation of climate change in the local government and Nigeria in general.

Keyword: Climate Change, Local Governance, Traditional Rulers, Community Development, Mitigation, Community Development Association (CDA)



**INSTITUTIONAL DIGITAL OPEN ACCESS REPOSITORIES IN NIGERIAN
UNIVERSITIES: ISSUES AND CHALLENGES**

Peter Olubunmi Olubiyo

College Library, Adeyemi College Education, Ondo, Nigeria

Lydia Mercy Olubiyo

Department of Library and Information Science

Kogi State Polytechnic, Lokoja, Nigeria

Abstract

Universities as institutions of higher learning place emphasis on research as one of their core functions apart from teaching and community services. A key criterion that is used to measure the standard of a university is the quality and quantity of research output. A university that falters in the production of brilliant researches that can be applied in moving the society forward socio-economically and technologically, has lost its relevance. It is therefore essential that in expanding the frontiers of knowledge and imparting the society positively, adequate attention should be placed on the intellectual output emanating from the ivory towers. The situation where the totality of the research output emanating from a particular university cannot be ascertained will make it very difficult to evaluate the university output and could also impede the collation and onward transmission of the researches that can benefit different segments of the society to the parties concerned. This reveals the need for the establishment of institutional repositories (IRs) in Nigerian universities. Thus, Institutional Repository becomes imperative to maximize the visibility and global impact of the institution's intellectual outputs, and also considering the weakness of the existing model of publishing which is rigorous, time consuming, expensive, and scarcely caters for the grey materials and other local scholarship. In the light of the innumerable benefits of institutional repository, university libraries all over the country, Nigeria should resort to institutional repository as a means of coping with preserving and disseminating (for full impact) their ever increasing scholarly out.

Key Words: Institutional Digital Open Access Repositories, Nigerian Universities, Issues and Challenges

Introduction

Today, the availability and utilization of information determines the effectiveness and visibility of any institution - be it academic, commercial, political, religious or cultural. The unrelenting quest for information in this 21st Century can, therefore, be rationalized on this score. This strong desire and eagerness for access to information has led to the establishment of information and media centers which has further restructured the way information is provided, especially, in higher institutions of learning. Thus, the sustained move for reorganization of information sources, enhance visibility in academic research outputs and strengthen the degree of information provided led to the establishment of various repositories. However, before now, these repositories were known to be mere archives as a result of difficulty in access (Chukwueke, Nnadozie and Okafor, 2020).



Universities as institutions of higher learning place emphasis on research as one of their core functions apart from teaching and community services. A key criterion that is used to measure the standard of a university is the quality and quantity of research output. A university that falters in the production of brilliant researches that can be applied in moving the society forward socio-economically and technologically, has lost its relevance. It is therefore essential that in expanding the frontiers of knowledge and imparting the society positively, adequate attention should be placed on the intellectual output emanating from the ivory towers. The situation where the totality of the research output emanating from a particular university cannot be ascertained will make it very difficult to evaluate the university output and could also impede the collation and onward transmission of the researches that can benefit different segments of the society to the parties concerned. This reveals the need for the establishment of institutional repositories (IRs) in universities (Anenene, Alegbeleye and Oyewole, 2017).

Mellon (2006) in Akpokodje and Akpokodje (2015) states that a repository is a networked system that provides services pertaining to a collection of digital objects. Example of repositories include: institutional repositories, publisher's repositories, dataset repositories, learning object repositories, cultural heritage repositories, etc. therefore, Musa, Musa, & Aliyu, (2014) in Ukwoma and Ngulube (2019) described an institutional repository (IR) as a database for preserving the local content of academic institution. Local content consists of materials such as examination question papers, research publications, working papers and inaugural lectures generated in institutions of higher learning. These materials contain information that are relevant for teaching, learning and research in universities. They are often difficult to come by since many of them are not in published form. In some cases, the materials are leaflets that can easily become brittle. IRs provide a safe option for the preservation and accessibility of the local contents in digital format. IRs preserve and secure records that would have been obliterated by age.

There is no contradiction to the fact that information and knowledge have assumed position as one of the factors of production. The generation, acquisition and utilization of information and knowledge are indispensable factors for growth and development. Knowledge has become the most important factor that determines the standard of living and pace of development of nations. This is because the contemporary world is knowledge-based and all meaningful participation in its activities presupposes this status (Igwe, 2014). Ghosh and Das (2007) in Igwe, (2014) note that, the contrast between developed and developing countries is in terms of generating and having access to knowledge. According to Christian (2008) in Igwe, (2014), the World Bank has explored the complex relationship between knowledge and development, and made a case for the need to address information problems as a way to eradicate poverty and improve people's lives in developing countries. It was also observed that the most technologically developed countries of the world today are knowledge-based. Developed countries invest so much time and money in research to acquire the knowledge necessary for development. Information and knowledge are the major drivers of economic change, restructuring businesses, improving skills and generating employment. In other words, unhindered access to free flow of scientific, technological, academic, and economic information at the right time would assist and facilitate the activities of other production factors. This will lead to increased productivity, which will invariably contribute to development. Thus, this make need for institutional repository in Nigerian Universities paramount.



Digital Open Access Repositories in Nigeria

OpenDOAR, (2019) in Adewole-Odeshi and Ezechukwu, (2020) described the concept of Open Access (OA) implies the provision of unrestricted access via the Internet to research and scholarly information resources. OA is characterized by free online access and availability of information materials on the Internet without charge to users (readers) and libraries; granting users the license to make legal and non-commercial use of the materials, subject to proper acknowledgement of the rights of the original owner (author) through citation and referencing. An Open Access Repository in an Institution (OARI) therefore means an online access to the research output and intellectual products created by the academic and research staff and students of an institution via the Internet without barriers. The open access movement emerged in the digital era as a response to increasing legal and economic barriers by commercial scholarly publishers which made access to research output difficult especially to people in developing countries. Thus, the movement seeks to promote free and open access to research outputs devoid of permission barriers and unnecessary legal restraints, with the use of ICT components especially the Internet. The past decade has witnessed the birth of OA initiatives, statements and conferences in support of the movement.

The challenge at this point is on how to make the research and intellectual outputs of Nigerian Higher Educational Institutions (HEIs) and research institutes available for easy accessibility, utilization and possible application. Such availability will invariably facilitate the linkages between industries and research, and possibly attract greater funding for Research and Development activities. The research outputs from HEIs and research institutes are mainly in the form of grey literature, i.e. unpublished print-based information resources and knowledge assets such as research reports, journal articles, theses, dissertations, conference and seminar/workshop papers as well as indigenous research findings published in local outlets (Igwe, 2014).

Crow, (2004) in Igwe, (2014) expressed that an institutional repository is the digital archive of the intellectual products created by the faculty, research staff, and students of an institution and made accessible to end users both within and outside the institution, with few or no barriers. It is an online locus for collecting, preserving and disseminating in digital form, the intellectual outputs of the staff and students of academic and research institutions. The research output includes electronic copies of peer-reviewed journal articles, theses and dissertations, technical/research reports, conference proceedings, seminar and workshop papers, teaching materials, monographs, inaugural lectures, matriculation and convocation lectures, lectures at commissioned events, papers and publications of other intellectual activities in the institution, etc.

These scholarly works have limited circulation even within the institutions of their origin. They also lack proper documentation in national and international bibliographic databases. They are neither indexed nor abstracted in international indexing and abstracting agencies; as such, they are not visible to the scholarly and research communities. This situation has retarded the level of development which we would have experienced in various sectors of the economy before now, and at the same time have affected the rating of Nigerian institutions. For instance, Harnad, (2006), Gbaje (2010) in Igwe, (2014) reported that the poor visibility has affected the webometric analysis and ranking of Nigerian universities, as the ranking is usually based on the volume and quality of e-publications emanating from each university. There is therefore the need for the application and use of information and communication technologies (ICT) for the development and management of the intellectual outputs and research findings, which will be in open access domains for easy accessibility. This is because, the easier the access to research results in open access repositories, the more readily they can be read and understood, used, applied and built upon.



OpenDOAR, (2019) in Adewole-Odeshi and Ezechukwu, (2020) asserted that an open access repository is a database or a virtual archive established to collect, disseminate and preserve scientific output like scientific articles and dataset, and make them freely available. Repositories can be either linked to an institution or department or linked to a research field or subject, i.e. Institutional or Subject Repositories. Open access repositories are domiciled in a website known as OpenDoar. OpenDOAR was launched in 2005. It is a quality-assured global directory of academic open access repositories. It enables the identification, browsing and search for repositories, based on some features, such as software or type of material held as well as location. OpenDOAR, (2019) in Adewole-Odeshi and Ezechukwu, (2020) expressed that OpenDOAR collects and provides information solely from sites that wholly embrace the concept of open access to full text resources that are of use to academic researchers. Sites that have any form of access control and prevent immediate access are not included; likewise, sites that consist of metadata records only are also declined.

According to Christian, (2008), Gbaje, (2010) in Igwe, (2014), there was statements and conferences on Open Access which include the Budapest Open Access Initiative (BOAI) by the Open Society Institute in 2001, the Bethesda Statement on Open Access Publishing in 2003, the Berlin Declaration on Open Access to Knowledge in the Sciences and Humanities, the United Nations Summit on the Information Society Declaration of the Principles and Plan of Action, the Organisation for Economic Cooperation and Development (OECD) Declaration on Access to Research Data From Public Funding, the International Federation of Library Association and Institutions' (IFLA) Statement on Open Access to Scholarly Literature and Research Documentation in 2004. In 2007, The Canadian Institutes of Health Research (CIHR) announced an open access mandate for CIHR-funded research. In a similar vein, in January 2008 the National Institute of Health (NIH) released the text of its new open access mandate for NIH-funded research. The mandate requires all NIH funded researchers to deposit their article into PubMedCentral – an open access archive. Same year, the Harvard University Faculty Council approved a plan to make open access archiving for all research works produced by the faculty members. Similar policy has also been adopted by some other tertiary institutions in the world.

Hence, Christian, (2008), Gbaje, (2010) in Igwe, (2014), opined that the availability and accessibility of the research outputs and intellectual products of Nigerian universities, polytechnics, research institutes, colleges of technology, colleges of agriculture, colleges of education, etc in open access repositories will contribute significantly to the achievement of vision 20: 2020. Oke (2010) in Igwe, (2014) posits that the polytechnic system, and indeed other tertiary institutions and research-based organisations, must strive to be part of the global knowledge network where they can make inputs and also benefit from the contributions of others. This is possible via the development of open access institutional repositories (with the use of open source software).

Oke (2010) in Igwe, (2014) noted that having open access repository is to create global visibility for an institution's scholarly research output, thereby projecting the image of the institution and its host country. One of the principles underlying the open access initiative is that wide dissemination of, and access to research and scholarly outputs is desirable so that subsequent works can be informed by the earlier works of others. If this principle is taken away, what is left is an endless circle of duplication whereby scholars and researchers are constantly 're-inventing the wheel' because they are unaware of the fact that an in-depth research has already been conducted on a subject matter which they are about to research or are currently researching. Thus, to avoid this unnecessary duplication saves time and enables researchers to expend their effort in other areas of human endeavor that has not been explored or researched, thereby moving at a faster pace in scientific investigation and the application of research results to key sectors of the economy for sustainable development. Open access increases the efficiency of scientific discovery since the likelihood of wasting resources and time on



duplicative investigation decreases when researchers have comprehensive access to the results of earlier work. More so, the fundamental principle of research is that wide dissemination of research results is vital for validating these results and advancing the field of knowledge.

Digital Repository Facilities

In order to ensure the success of the Digital Repository Project in Ahmadu Bello Univeristy (ABU) Zaria, Nigeria, Aliyu and Mohammed (2013) identified some of the equipment and facilities acquired and installed for converting source materials from physical/ analogue formats to digital one. These include:

1. Hardware:

(a) Scanners: Based on the fact that there is no single scanner that can provide all digitization needs for ABU Digital Repository Project, as such a variety of scanners are needed to complete different digitization tasks, three Xerox Documate 752 high-speed duplex scanners were procured for the take-off of the project to replace the old HP flatbed scanners being used previously. The scanners were selected based on the following reasons:

- i. Volume (average number of pages and images to be scanned)
- ii. Scanner duty cycle (average number of scans recommended for a scanner model)
- iii. Need for color, black and white, or gray scale scans
- iv. Resolution and format
- v. Document size
- vi. Single or double sided (also referred to as simplex or duplex)
- vii. Scanner warranty
- viii. Maintenance requirements.

(b) Computers: Normally, the computer to be used for any scanning activity/tasks must be able to handle very large files which can be memory and processor intensive. Thus, new computers with 2GB Random Access Memory (RAM) and disk space were acquired. The image-processing speeds have a direct impact on the workflow and the speed of the scans.

(c) Monitors: Monitors are used to preview the quality of images to be captured. A large-screen monitor that supports a high-resolution display should be used for image editing and quality control. This was why 19 inches (flat panel) was acquired to properly review images. The ability to calibrate and control the monitor contrast, brightness, and color temperature is very important.

2. Software

Naturally, software are needed for the hardware to work. Some relevant software were thus acquired and installed for such purposes. These include:

(a) Optical Character Recognition (OCR) software to convert the hardcopy image to a digital one and then into text that a word processor can understand what is being done using the Abby Fine Reader 8.0 as installed. ABBYY FineReader is a powerful, yet easy-to-use application for professional



quality conversion of document images and PDF files to editable and searchable electronic files. The product delivers outstanding accuracy when converting a variety of document types including tables and spreadsheets, magazine articles, contracts, and faxes. Enhancements in version 8.0 give FineReader new intelligence, making it more accurate, flexible, and adaptable for a wider variety of users than ever before.

ABBYY FineReader 8.0 redefines OCR accuracy and performance by delivering:

- a significant increase in overall recognition accuracy - with up to 30 percent accuracy improvement for "difficult-to-read" images such as faxes and documents scanned at low resolution;
- more intelligent PDF conversion - with smarter, faster processing and output to searchable, secure, and tagged PDF files;
- higher productivity and greater applicability - with new automation tools, fast processing options and ability to use FineReader for a wider range of tasks, including digital camera support and "instant" OCR with a new Screenshot Reader application (Abby, 2005).

(b) Usually, files could be converted from one format to another e.g. Documents are typically stored as Tagged Image File Format (TIFF), Portable Document Format (PDF), Portable Document Format for archiving (PDF/A), or Joint Photographic Experts Group (JPEG) files. The most preferred format selected for use is the PDF formats specifically; the Nitro PDF express was adopted in ABU, Zaria, Nigeria.

(c) Content Management software: Indexing record can be the most costly part of any digitization effort, yet it is vital for allowing users to find the information they require. Indexing can include assigning and capturing various metadata including bibliographic data and subject terms. The Dublin Core metadata has been adopted for such purpose.

Issues and Challenges of Nigerian Universities' Institutional Repositories

Okoroma and Abioye (2017) are of the note that universities in Nigeria are major centres for research output and other valuable literature. However, many of the literature remain unpublished and are never utilized by the masses. There is a glaring divide between the explosive output of literature in the universities and the users of information for education, research and manpower development. Thus, Institutional Repository becomes imperative to maximize the visibility and global impact of the institution's intellectual outputs, and also considering the weakness of the existing model of publishing which is rigorous, time consuming, expensive, and scarcely caters for the grey materials and other local scholarship. In the light of the innumerable benefits of institutional repository, university libraries all over the country are resorting to institutional repository as a means of coping with, preserving and disseminating (for full impact) their ever increasing scholarly out.

Literature has revealed insignificant adoption rate of institutional repository in Nigeria. OpenDOAR, (2014) in Okoroma and Abioye (2017) analyzed that out of 3,370 institutional repositories in the world in the year 2014, Africa has only 95 (3.7%) repositories and Nigeria has just 8 (7.9%) out of 95 repositories in Africa.

Adewole-Odesi and Ezechukwu, (2020) illustrated the growth of Nigerian open access repositories since 2009 when it started. The researchers noted that before 2009 there was no Institutional Repository available in Nigeria. The first Open access Institutional Repository was developed in 2009 at University of Jos. Only 5 (20%) repositories in Nigerian Universities were created between 2009 and 2013. The highest number of institutional repositories constituting 11 (44%) were developed by Nigerian institutions between 2014 and 2016; followed by 9(36%) between 2017 and 2019. Thus, the analysis showed that there are 25 (100%) open access repositories in Nigeria and they are institutional. No Nigerian repository is Disciplinary, Aggregating or Governmental. It was



also revealed that open access repositories in Nigeria make use of two main softwares which are Dspace with a total number of 20 (80%) and Eprints 4 (16%) with 1(4%) unknown.

Akintunde, (2002) Akintunde, (2010) in Akpokodje and Akpokodje (2015), expressed that internet access in the University of Jos started with a small step of accessing electronic mail through American Online in 1996 and Skannet in early 1997. In June 1997 the backbone for a campus Wide area Network was laid with a server maintained in the NuNet office. The intranet was activated in 1998. The intranet was used to send and receive mails as well as host the University's newly created website which was created in 1998. Based on the availability of Internet (wired and wireless) on campus, the University of Jos under the leadership of the library launched its Open Access Institutional Repository- <http://dspace.unijos.edu.ng> – in June 2009. In the research it was stated that it was a realization of three years' dream. Between 2006 and 2009, there was a very high demand by both library staff and patrons to promote access to the University's resources.

Researches had it analyzed that the growth of open access institutional repositories in Nigeria over the last 10 years is slow. OpenDoar website is a directory of all open access institutional repositories in the world. It is a quality-assured global directory that enables the identification, browsing and search for repositories. OpenDoar was analyzed to get statistics of institutional repositories in Nigeria based on such parameters as: type, status, software, total number of records, subject covered and content uploaded. Findings also show that a total of 68,610 items have been uploaded in the 25 open access repositories in Nigeria since their creation till date with University of Nigeria, Nsukka having the highest upload of 23,367 items, however, University of Jos started the initiative of open access institutional repositories in Nigeria in 2009. Dspace software was found as the preferred Software for most of the repositories. The study also revealed that most of the institutional repositories are multi-subjects based. Their study recommended among other things that Institutional repositories should be made a prerequisite for Nigerian Universities Commission (NUC) accreditation and funding should be made available to set up functional Institutional repositories in Nigeria (Adewole-Odesi and Ezechukwu, 2020).

Akintunde, (2002) Akintunde, (2010) in Akpokodje and Akpokodje (2015) observed that immediately after the installation of IR, the visibility of research output of University of Jos became very obvious, thus, University of Jos moved from nowhere on the map to 4th position in Nigeria, 70th in Africa and 7000th in the world on the Ranking Web of World Universities for January 2010 ranking. The ranking web of world universities has attracted a lot of interest in the last two years among Nigerian universities. The process of making institutional resources available and visible demands a collective effort of scholars – who contribute reports of their ongoing and completed researches; librarians – who organize resources and put them in appropriate templates for upload, visibility, and accessibility; and technicians – who ensure that network infrastructure is up and running 24/7 are ground. The institution itself plays a critical strategic role of providing critical infrastructure such as bandwidth and electric power, and also ensuring through policy (and enforcement), that the university community makes resources available on the Internet.

Christian, (2008), Gbaje, (2010) in Igwe, (2014) asserted that higher education institutions and research institutes in Nigeria are yet to take full advantage of the opportunities and benefits provided by open access institutional repositories for accelerating the development of the country. Some of the issues identified by existing literatures as being responsible for the slow uptake of institutional repositories in the country include lack of knowledge or awareness of open access institutional repository, poor state of ICT infrastructure (server, bandwidth, electricity), inadequate technical and skilled staff, apathy on the part of institutional top management, inadequate advocacy for open access repositories, poor or inadequate funding, copyright and intellectual property rights. Others include absence of relevant policies, inadequate attention to institutional libraries among others.



In addition, institutional repositories offer several benefits for the management and preservation of the research output generated within universities. These benefits have not been achieved without challenges. Numerous factors that militate against the utilization of IRs, ranging from managerial and infrastructural issues to content submission, have been identified. The provision of content by authors and researchers of institutions is one of the major challenges. Thus, Nixon (2002) , Nwokedi (2010) as cited in Ukwoma and Ngulube (2019) asserted that the central challenge for developing an IR does not lie with technical implementation but in instilling a change of mindset among researchers to freely make self-archiving an important part of their academic life. It was discovered that many lecturers are not willing to submit their work to IRs. However, Watson (2006), Royster (2007) in Ukwoma and Ngulube (2019) stated that many articles received from authors were requested, but the academics are not really aware of what the libraries will be doing with the papers submitted.

Way Forward to the Challenges of Nigerian Universities' Institutional Repositories

In the light of the above issues and challenges, there should be the following as way forward:

Formulation of a national policy to mandate all Higher Educational Institutions (HEIs) and research institutions in the country in order to set up open access repositories for global visibility of their research results and possible utilization for development.

□ Aina, (2001) in Igwe, (2014) expressed establishment of a national centre or agency for the coordination of research to implement the above proposed policy. South Africa has a similar body known as National Research Foundation (<http://www.nrf.ac.za>), which hosts a database of major researches in South Africa.

□ Igwe, (2010) in Igwe, (2014) asserted that there should be formation of consortium for the procurement of ICT components, and internet bandwidth among HEIs and research institutes for faster access to the internet where the repositories will be domiciled. Formation of consortium among libraries is a wonderful idea for the accomplishment of objectives that may not be satisfactorily achieved independently. A good example is the partnership of six Nigerian university libraries – the Obafemi Awolowo University Ile-Ife, the Ahmadu Bello University Zaria, the University of Port Harcourt, the Bayero University Kano, the University of Ibadan and the University of Jos – for the procurement of the best acclaimed integrated library automation software, the Virtual Library Management Software from Visionary Technology in Library Solution (VTLS) USA, at a lower cost than they would have paid individually. This drastically reduced the cost of the software and provides sufficient expertise in its maintenance. Gbaje & Okojie, (2011) in Igwe, (2014) noted that in another development, international agencies and non-governmental organisations like the partnership for Higher Education in Africa (including the Ford, Carnegie, MacArthur, and Rockefeller Foundations) in 2005 assisted a consortium of 13 African universities, 6 from Nigeria (the aforementioned universities) to lower Internet connectivity cost. The partnership has donated over \$5 million to make satellite bandwidth available to the consortium at \$2,330 per Mbps/month instead of \$7,300. That is the power of partnership and formation of consortiums.

□ The copyright and intellectual property rights should be given a good face in the country.

□ Nigeria needs non-governmental organisations (NGO's), corporate bodies, professional associations and individuals to serve as advocates for the open access movement and open access to research findings and scholarly resources.

□ Higher education institutions, research institutes, scholars, researchers, lecturers, and other stakeholders in Nigeria should accept and participate actively in the open access to knowledge initiatives. When an institution collects and shares its output, the members of the institution benefit



while also making the world academically richer by allowing scholarly communication to flow more freely, which will be utilized and applied for accelerating developmental programmes. The repository software products that are available as open source are proving to be effective in fulfilling these informational harvesting functions. Libraries are ideal place for initiating and managing open access repositories, and thus fulfill their duty to their various institutions as stewards of information. Nigerian government, its higher education institutions and research institutes should make hay while the sun shines in developing open repositories with content of their research output that can be easily accessed, used and applied.

Conclusion and Recommendations

This study is an eye opener to the fact that there is a very slow growth rate of open access repositories in Nigeria. For Nigeria to take its place in the intellectual environment, its intellectual content must be made open and visible online because this is the era of Knowledge Democracy which signifies knowledge is of the people, by the people and it is for the people, so it should not be hoarded. Based on these findings, the following recommendations were made by Adewole-Odeshi and Ezechukwu (2020):

1. Institutional Repositories should be made a very important prerequisite for Nigerian Universities Commission's (NUC) accreditation of Universities.
2. Librarians should be trained to possess ICT skills so that they do not only upload content but also provide ICT support when needed without consulting the ICT department.
3. Institutions should also ensure that the standard of their theses and dissertations is not compromised so that it can be easily uploaded without fear of plagiarism.
4. Regulatory bodies of Library and information Science such as Librarians Registration Council of Nigeria (LRCN) should establish and implement policies concerning Institutional Repositories in Nigeria.
5. Institutions should ensure that ICT facilities are put in place to ensure the smooth running of institutional repositories.
6. Funds should also be made available by institutions because setting up and running a functional institutional repository is capital intensive.

References

- Abbyy (2005). FineReader 8.0 Redefines OCR Accuracy. Available at:<https://www.abbyy.com> › company › news › abbyy-fin...
- Adewole-Odeshi, E. and Ezechukwu, O.C. (2020). An analytical study of open access institutional repositories in Nigerian Universities. Available at: <https://creativecommons.org/licenses/by-nc/4.0>
- Akpokodje, V. N. and Akpokodje, E. T. (2015). Availability and utilization of institutional repositories as indicators to institutional web ranking. *European Journal of Computer Science and Information Technology* 3, (2), 29-40.



INTERNATIONAL ASIAN CONGRESS ON CONTEMPORARY SCIENCES – VII

- Aliyu, A. and Mohammed, Z. (2013). Deployment of Ahmadu Bello University Zaria, Nigeria institutional digital repository. *The Information Manager*, Vol.13 (1& 2), 30-34
- Anenene, E.E., Alegbeleye, G.B. and Oyewole, O. (2017). Factors Contributing to the Adoption of Institutional Repositories in Universities in South-West Nigeria: Perspectives of Library Staff. *Library Philosophy and Practice (e-journal)*. Available at: <http://digitalcommons.unl.edu/libphilprac/1508>
- Chukwueke, C., Nnadozie, C.D. and Okafor, V.N. (2020). Enhancing Academic Visibility of Faculty Members in Nigerian University Community: The Role of Institutional Repositories. *International Journal of Research and Scientific Innovation (IJRSI)*, VII (IX), 87-94. Available at: www.rsisinternational.org
- Igwe, K.N. (2014). Open Access Repositories in Academic and Research Institutions for the Realization of Nigeria's Vision 20: 2020. *International Journal of Information Science and Management*, 12(1), 33-46
- Okoroma F. N. and Abioye A. A. (2017). Institutional Repositories in University Libraries in Nigeria and the Challenge of Copyright. *Advances in Social Sciences Research Journal*, 4(15), 62-72.
- Ukwoma, S.C and Ngulube, P. (2019). Obstacles to the Utilization of Institutional Repositories by Academics in Higher Education in Nigeria. *Webology*, 16 (1), 138-150. Available at: <http://www.webology.org/2019/v16n1/a183.pdf>



ATTITUDE TO THE SOCIAL UPRISING OF THE "IRANIAN WORLD MOVEMENT WOMEN'S" AND THE "WOMEN'S REVOLUTION" OF THE IRANIAN PEOPLE IN IRAN AND WORLD WITHIN THE FRAMEWORK OF THE NEIL SMELSER THEORY TO FORM A COMPREHENSIVE AND TRANSFORMATIVE SOCIAL MOVEMENT

Vorya Shabrandi

Knowledge of Master of International Relations University of Iran

<https://orcid.org/0000-0002-6013-2115>

Abstract

At this time, cyberspace has collapsed all the walls and everything is accessible to everyone. So this message is quickly conveyed to everyone and brings a group with it, just like a stone that throws a person in the middle of a quiet pond, starts from the same point ... when the Backgrounds of dissatisfaction are in a favorable community and in fact people with People with restrictions and deprivation. They are restrictions and deprivation; they cannot express their hearts thought as they wish. They inevitably resort to a device that can express their opinion. The best and most accessible option is to resort to these challenges. In more democratic societies, these challenges may not be objected to by the social system of that society, but in a traditional and conservative society, every move is considered by the modernists, because that society is not willing to undermine its traditional values, it does not want to change society within society. The death of zhina (Mahsa) Amini, a Kurdish woman who was arrested by the guidance patrol and died, at the same time as the economic collapse, poverty and marginalization and destruction of the country's ecosystem, we also witness the devastating policies of the Islamic Republic. The subjugation of half of the country's population with anti -feminine and patriarchal laws is one of the strong and highly protected policies of the Islamic Republic, with the character of the gender apartheid appearance of more than four decades of anti -female rule of the Islamic Republic. So, reacts. We also see the devastating policies of the Islamic Republic. The subjugation of half of the country's population with anti - women's and patriarchal laws is one of the strong and highly protected policies of the Islamic Republic, with the character of the gender apartheid appearance of more than four decades of anti - women's rule of the Islamic Republic. We are the devastating policies of the Islamic Republic. The subjugation of half of the country's population with anti - women's and patriarchal laws is one of the strong and highly protected policies of the Islamic Republic, with the character of the gender apartheid appearance of more than four decades of anti - women's rule of the Islamic Republic. The national uprising of the Iranian people in hundreds of cities of Iran and the world in September is a huge and multilateral political event that has transformed the Iranian public arena. Its geographical area learned at least hundreds of Iranian cities and the world and had a significant appearance in the capital. The wave of recent popular protests against the current sovereignty in Iran has shown the biggest point of view: Forty - three years after the revolution, the government has not yet been able to provide an efficient economic model. The protests, the widespread and largest scene of opposition to the regime ruling Iran, has been to express public dissatisfaction since the Green Movement to the present day.

The Slogans of " *Women, Life, Freedom* " and "*Death on the Dictator*" of the demonstrators have specifically targeted the undisputed power of Ayatollah Ali Khamenei and the Velayati -e Faqih. The issue of compulsory hijab became a window for the widespread emergence of accumulated dissatisfaction and demands that had not been answered. In the public space of the country, there is no opportunity to provide alternative views for running the country such as the mandatory Hijab (veil) of separation of religion and government, referendum, and ending regional military



interventions. The uprising of November and October 2019, like the recent uprising, was the accumulation of a collection of economic, political, social, cultural, environmental and international people that led the country to a compound crisis, which is virtually impossible to get rid of the existence of the Islamic Republic. Thus, the most important factor that created the recent explosive conditions was nothing more than a comprehensive bankruptcy of the Islamic Republic and the overwhelming majority of the Iranian people from the public right and the pervasive calamities that require this hellish system. It has become a spark of explosion and a turning point in social uprisings against the Islamic Republic throughout its life. This is a promise of transition from single -case and separate street movements, though the former chain and destructive to the first "super movement" and "women's revolution" in Iran. The recent movements of the Iranian people are highly motivational and activated, with more warrior and militancy that, overall, makes it more radical and puts more pressure on the political system. But organizing and leadership does not work effectively and relies on the short -term and short -term field forces. Thus, it does not have the essential characteristics of the social movement. So, the main question of the article is whether the social uprisings of the Iranian people with the spark of the "super movement" and the " women's revolution" in Iran lead to the revolutionary and transformative social movement? In order to answer the research question, In considers the framework of the theory of the Neil Smelser (sociologist) for six stages to form a revolutionary and transformative social movement: out of the six essential stages that Neil Smelser is for the formation of a pervasive and transformative social movement. , Of the six essential stages that Neil Smelser considers to form a pervasive and transformative social movement, recent protests have taken the four steps of "structural background, structural pressure, expansion of generalized beliefs and accelerator factors", but still in the fifth stage. The formation of a coordinated group for political and social mobilization has not been reached that the boundary between the social movement with "social uprisings, street riots and violent conflicts" is considered. The research question is how social movements can be correlated and more effective in social change in a country such as Iran, where neither the presence of democracy nor the presence of powerful news parties, and the economic and class divisions and other social breaks have expanded sharply, and more effective in social change. Find? The answer to the question of the article is here in a country such as Iran, where neither the presence of democracy nor the presence of powerful news parties, and economic and class divisions and other social ruptures have expanded sharply, how social movements can be correlated and more effective in an effective role in Find social developments? In Iran today, along with classical social movements such as the labor movement, modern social movements such as the environment movement, women, youth, and oppressed ethnic movement. Movements that are generally unique, non -ideological, demand -based, anti -power and supernatural and do not necessarily derive from the position of individuals in production and have a horizontal, fluid, and jelly structure, but a religious and chain, and without centralized leadership and duality. Revolutionary or reformist is raised against structures. Pandemic Corona and imperialist crippling sanctions are not only the factors that have brought the country's economy to the catastrophe, but the deeply corrupt structure of the Islamic Republic itself is one of the main causes of the current deep economic crisis. The fierce collapse of the Rial rate against the Dollar, part of which is due to increased liquidity inhibition, monetary inflation caused by non -supportive printing, psychological factors resulting in large policies such as the continuation of nuclear gambling and its resulting sanctions, or other harmful economic policies, or other economic policies. There are a few rates of the Dollar, threw the Rial out of value. The single case of most of the demands of these movements, although reflects a kind of kinetic pluralism and their independence that enhances their ability to mobilize and dynamism, also limits their universality. But in a situation where not only the necessity but also the transformations of the liberation of a real possibility, and the developments ahead, not the calendar that will be historical, this uprising -must become an organized and efficient force with a song commensurate with the rapid developments of the present fateful era. If the Iranian popular uprising in the current historical opportunity fails to overcome the barriers to their organization,



INTERNATIONAL ASIAN CONGRESS ON CONTEMPORARY SCIENCES – VII

change in the Islamic Republic will at best lead to a "Passive Revolution" and conservative, and the formation of an alternative democratic system will emerge. It will be impossible to do so.

Keywords: Islamic Republic of Iran, Iranian people's, pervasive, social uprisings, Iranian world movement women's, women's Revolution, Mandatory Hijab (veil), Neil Smelser Revolutionary, transformative social movement